



3-Strand Class I Eye Splice

Class I ropes are made from any or all of the following fibers: olefin, polyester, or nylon.

The eye splice is used to place a permanent loop in the end of a rope, generally for attachment purposes to a fixed point. An eye is also used to form the rope around a thimble, which is used to protect the rope, especially when it is to be attached to a shackle, chain, or wire rope.

Although the 3-strand splice is the most common splice, and simple to perform, technique is important to preserve splice strength. Take care that the tucks lie neatly, as rope strength can be lost if the strands are twisted incorrectly.

Getting Started: From one end of the rope, count back 16 picks. Tape this section. Unlay the rope up to the tape then tape the end of each strand. Form the eye and mark a line around the standing part of the rope that will touch all 3 strands. Your individual taped strands will tuck under these marks. Draw a line on the eye for visual reference (optional).

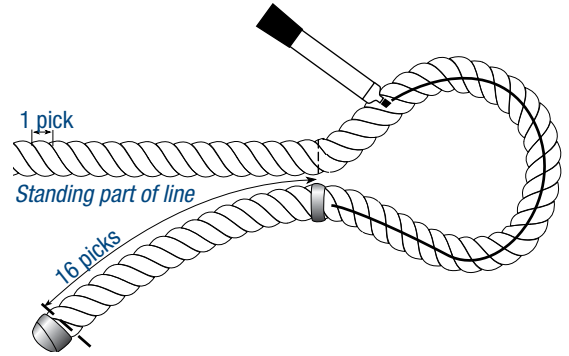

STEP 1 TUCKING FIRST STRAND

Note the mark around the standing part of the rope that touches all 3 strands. Your individual taped strands will tuck under these marks. Tuck the middle strand (Strand 1) under the nearest marked pick.

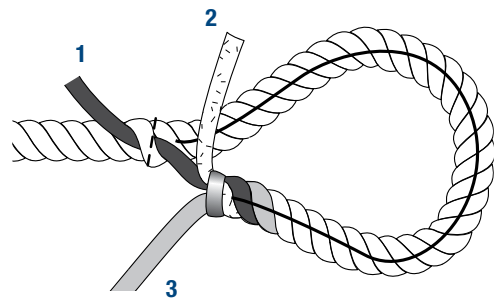

STEP 2 TUCKING SECOND STRAND

Tuck Strand 2 under the marked pick behind Strand 1.

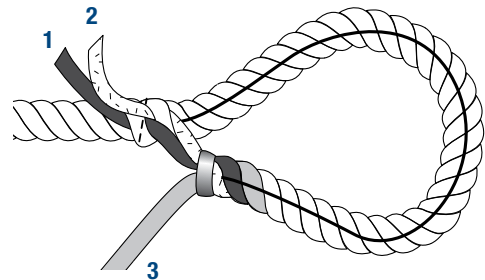

STEP 3 TUCKING THIRD STRAND

Turn the entire piece over. There is 1 working strand left to tuck and there is 1 strand left in the standing part of the rope that does not have a working strand under it. Make this tuck, continuing to tuck counter to the lay or twist of the rope. The first round of tucks is complete. Remove the tape, then tighten if necessary by pulling on the strand ends.

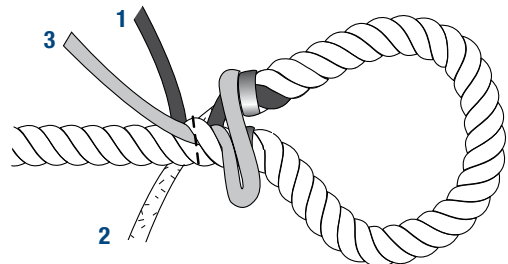

STEP 4 FINISHING THE SPLICE

Continue tucking the taped strands down the body of the rope. A tuck consists of skipping over the strand below and tucking under the next 1. When all 3 strands are tucked in this manner, 1 round of tucks is complete.

To finish the splice, perform 4 more complete tucks. Both the front and back of the splice should resemble the illustrations shown.

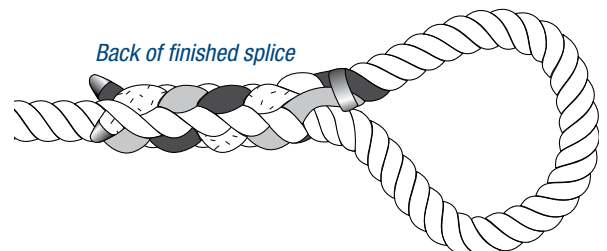
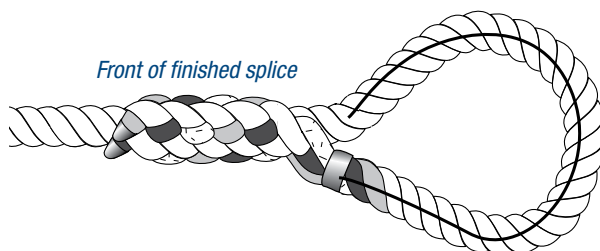

3-Strand Class I Long Splice

Class I ropes are made from any or all of the following fibers: olefin, polyester, or nylon.

STEP 1 MARRYING THE ROPES

Unlay the end of each rope a minimum of 36 picks. Lash securely with twine as shown to prevent ropes from coming apart further. Place ropes together, alternating the strands from each. Note how strands are numbered to show their relative positions throughout the long splice procedure.

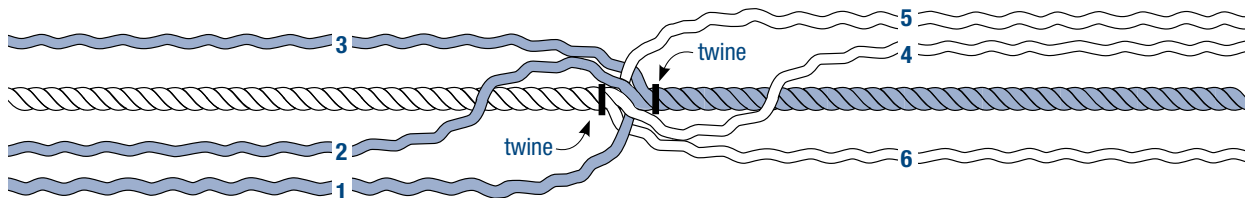

STEP 2 REPLACING STRANDS

Take lashing off one side. Unlay Strand 2 a minimum of 25 picks and replace it with a strand from the other side, Strand 5, as it is being unlaied. Lash securely as shown to hold strands in place. Be sure to place lashing at the "marriage point" to hold strands securely.

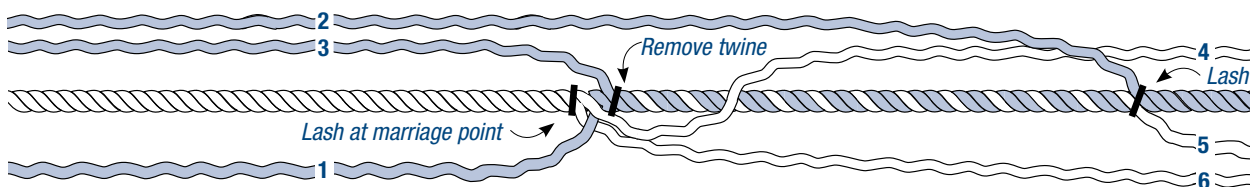

STEP 3 Step 3 is like Step 2, except in the opposite direction. Strand 6 is replaced with Strand 3. Each point is securely lashed as you go along. This leaves Strands 1 and 4 at the "marriage point."

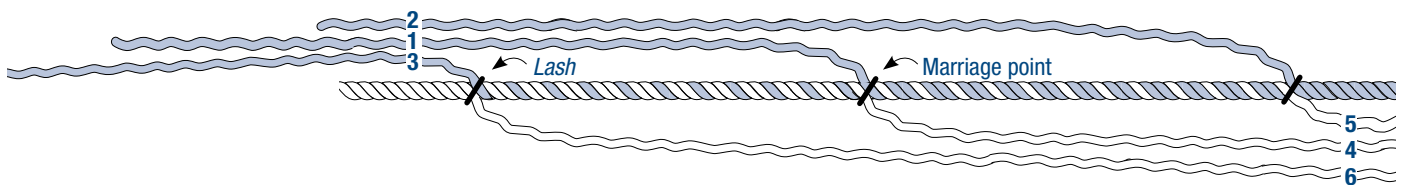

STEP 4 TYING OFF OPPOSING STRANDS

Remove all lashings and tie each pair of opposing strands (2 and 5, 6 and 3, 1 and 4) with an overhand knot. Be sure knot is tied in the direction of strand twist.

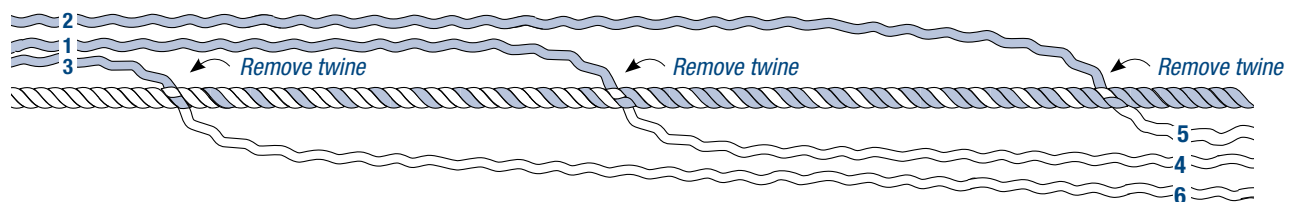



3-Strand Class I Long Splice

STEP 5 FINAL TUCKING

Tuck each strand 4 times. These tucks should be at right angles to the direction of the twist in the rope.

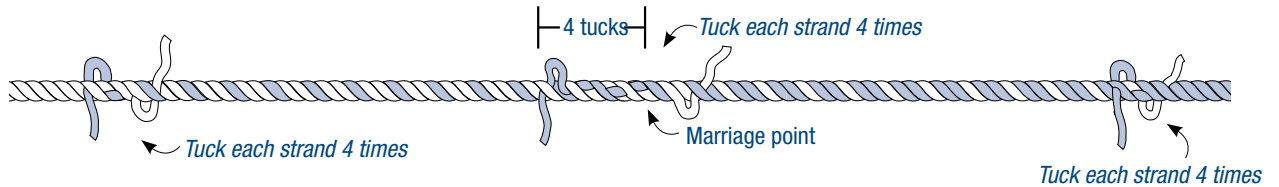

STEP 6 TAPERING AND FINISHING THE SPLICE

The splice may be tapered by reducing each strand by 1/3, then 2/3 and performing another set of tucks for each strand for each reduction. Now roll and pound well. Finally cut the strands off close to the rope.





3-Strand Class I Rope-To-Chain Splice

Class I ropes are made from any or all of the following fibers: olefin, polyester, or nylon.

Although the 3-strand splice is the most common splice, and simple to perform, technique is important to preserve splice strength. Take care that the tucks lie neatly, as rope strength can be lost if the strands are twisted incorrectly.

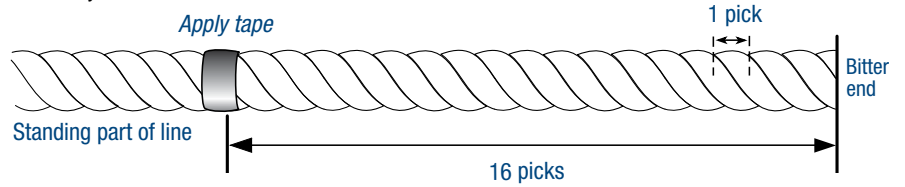

STEP 1 PREPARING THE ROPE

From one end of the rope, count back 16 picks. Unlay the strands from the bitter end up to the taped section. Tape each individual strand at the bitter end, to prevent unraveling, and mark each strand 1, 2 and 3.

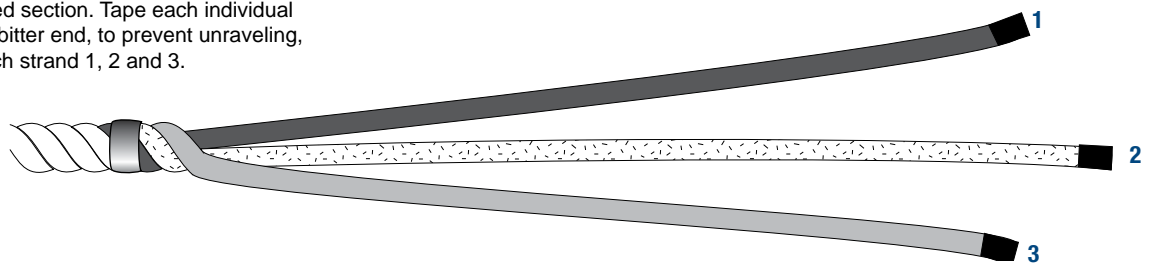

STEP 2 THREADING THE CHAIN

Line up the rope to the last link of the chain so that Strand 2 is in the middle and Strands 1 and 3 are on either end. Take Strand 2 and pass it through one side of the chain link. Strands 1 and 3 are to pass through the chain link from the opposite side, staying on the outside of Strand 2 (Fig. A).

Figure B

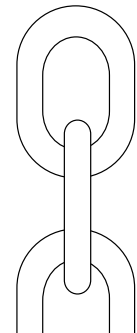
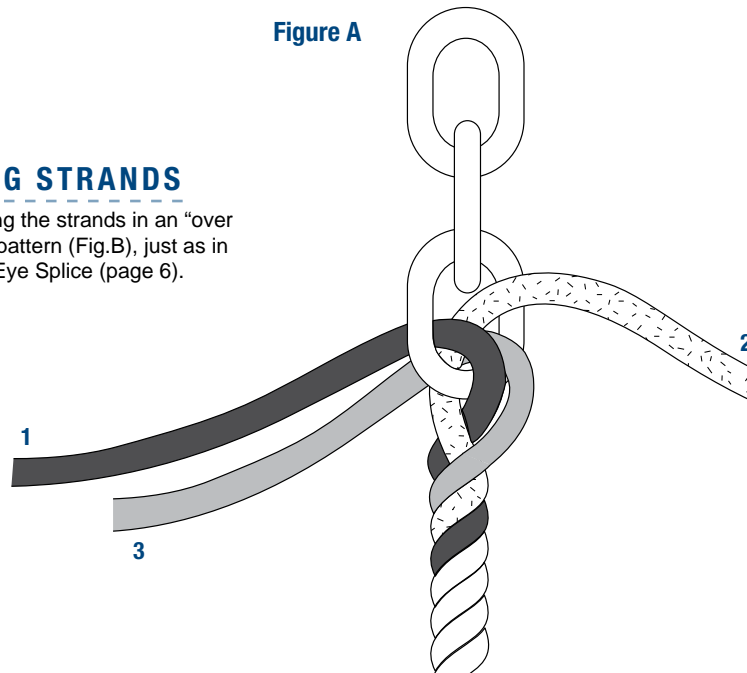
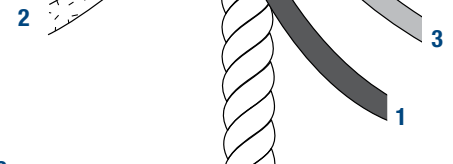

Figure A



STEP 3 TUCKING STRANDS

Begin tucking the strands in an "over 1, under 1" pattern (Fig.B), just as in a 3-Strand Eye Splice (page 6).





3-Strand Class I Rope-To-Chain Splice

STEP 4 FINISHING THE SPLICE

With Strands 1 and 3 tucked once, (Fig. C), turn splice over to tuck Strand 2 (Fig. D).

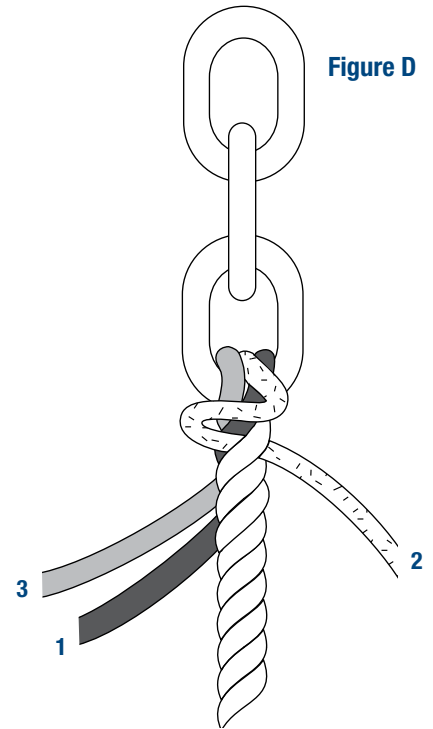
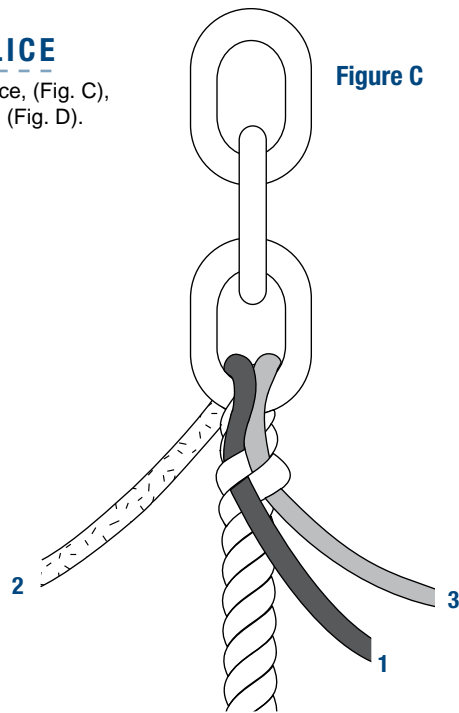

STEP 5 Perform 4 more complete tucks with all 3 strands. Tighten tucks if necessary.

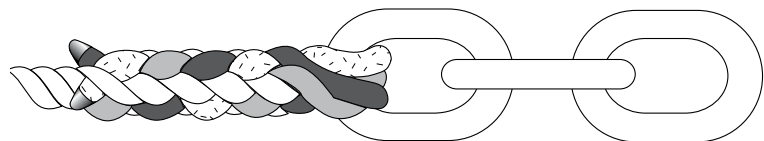
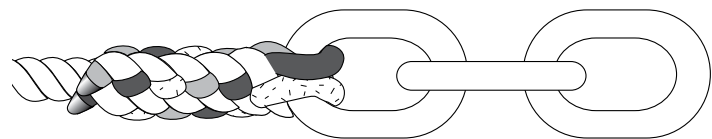

NOTE: This method of joining rope and chain is designed to minimize chafe between rope and chain, but as a matter of prudent seamanship, the splice should be checked regularly and remade if there is any evidence of wear.



8-Strand Class I End-For-End Splice

Class I ropes are made from any or all of the following fibers: olefin, polyester, or nylon.

GETTING STARTED

8-strand ropes, also known as plaited ropes, are composed of 8 strands grouped into 4 pairs. 2 of these pairs turn to the left (shown in gray), and 2 pairs turn to the right (shown in white.) Seen in this cross-section, the 4 strand pairs form the sides of a square. The strands that are on opposite sides of the square will rotate in the same direction.

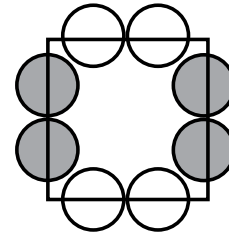

TOOLS REQUIRED

A splicing fid or marlinspike, sharp knife or scissors, plastic or masking tape, marking pen.

STEP 1 COUNTING AND MARKING

From the end of the rope, count a distance of 10 picks and apply tape securely around the rope immediately after the 10th pick, as shown in the illustration. This is Mark 1. Mark at both ends of the rope. Apply the tape securely enough so that it will not move during the splicing procedure.

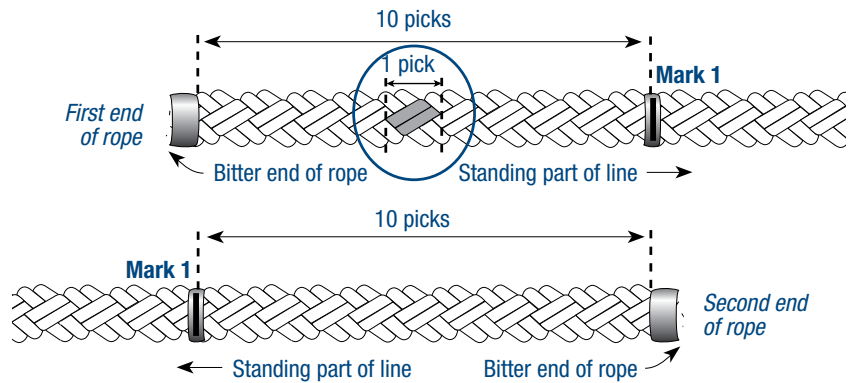

STEP 2 MARKING THE ROPE

Holding the end of the rope, note the pairs of strands going to the left. Mark these pairs. Mark the strands up to Mark 1 and continue to mark the strands for 5 or more picks beyond the tape at Mark 1.

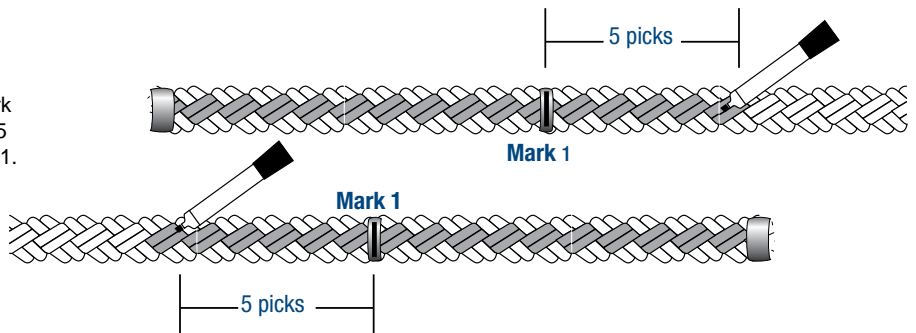

STEP 3 SEPARATING & TAPING

Remove tape from end, then re-tape the end of each strand. Start unlaying strands in their respective pairs. It is important to keep them together. After they are separated into pairs up to Mark 1, untwist the pairs. Tape the ends of pairs together with a taper as shown in Fig. A.

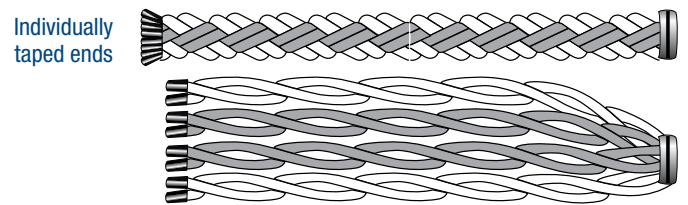

3A Lay out rope as shown in Fig. A, working from the right hand rope. Unmarked strand pairs are shown in white. Marked strand pairs are shown in gray. The left hand rope mirrors this arrangement.

Figure A

Pairs taped together





8-Strand Class I End-For-End Splice

STEP 4 JOINING THE PAIRS

To start, lay out the marked and unmarked strands as they appear in Fig. B.

Figure B

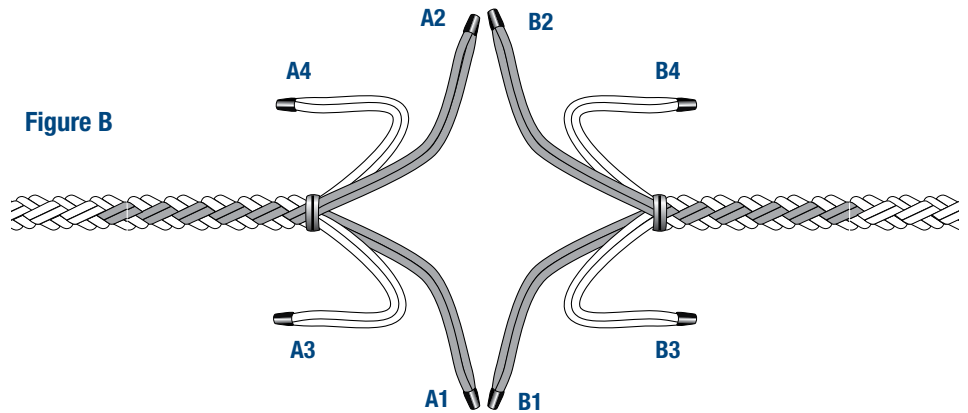

4A

It is important that the next steps of the procedure be followed carefully as shown in Fig. C.

Marked A1 strands go through marked B1 strands.

Marked B2 strands go through marked A2 strands.

Unmarked A3 strands go through unmarked B3 strands.

Unmarked B4 strands go through unmarked A4 strands. Keep strands untwisted.

Figure C

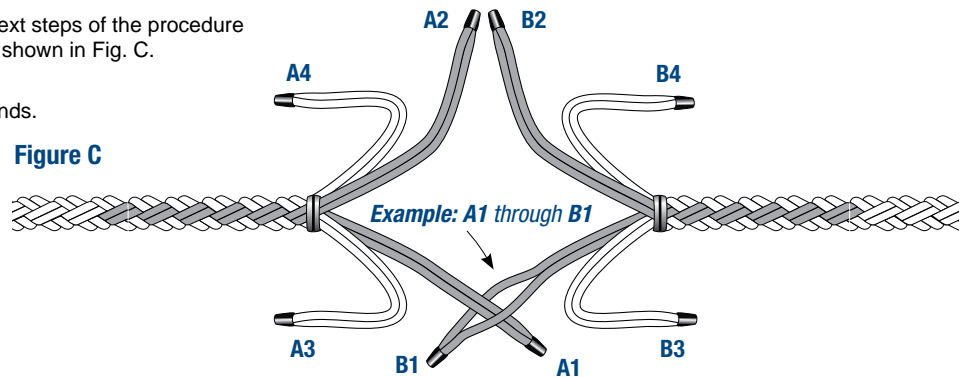

STEP 5 MARRYING THE ROPES

After the initial step has been completed on all strands, you should have something that looks like Fig. D. Marry the ropes as shown in Step 6. This part is preferably a 2-person job.

Figure D

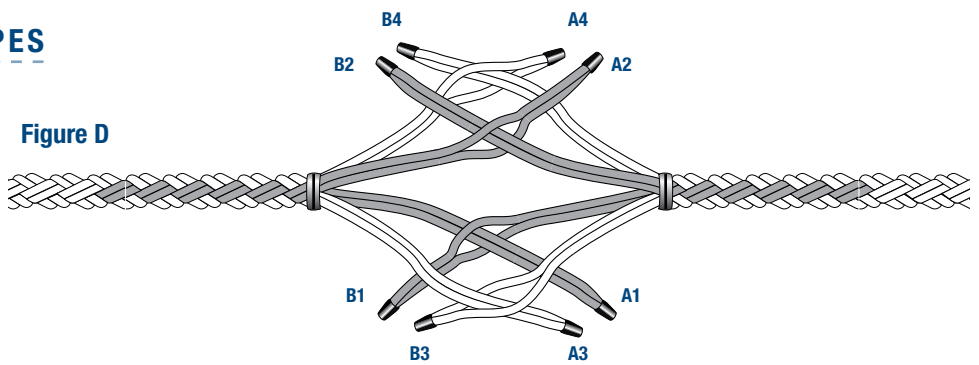

STEP 6 FINISHING MARRIAGE

Keep the ropes together snugly. Tie a piece of string tightly around the splicing point as shown in Fig. E. Remove both pieces of tape from the rope.

Figure E

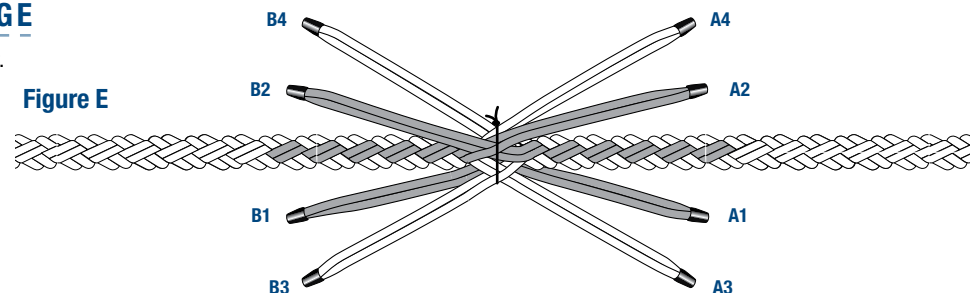



8-Strand Class I End-For-End Splice

STEP 7 STARTING THE TUCKS

Beginning at the marriage, tuck marked pairs of strands under the nearest unmarked pair. Then tuck an unmarked pair under the nearest marked pair.

Complete 1 full set of tucks in one direction with all the strands and then do another full set of tucks on the other side of the marriage. Pull everything tight before proceeding.

Continue tucking the strands around the rope until you have completed 4 full tucks on each side of the marriage with all the strand pairs.

Next, select the strand closest to the marriage point in each pair. Tape this strand and cut the excess off as shown below.

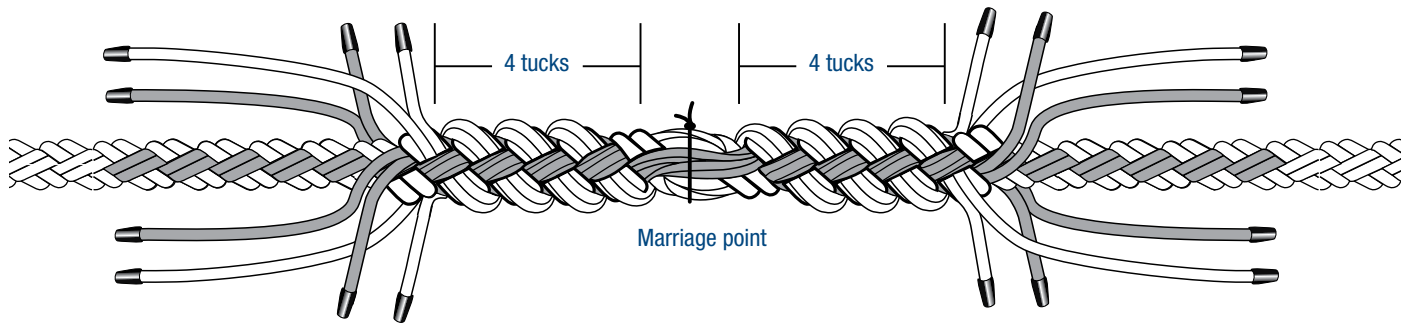

STEP 8 FINISHING THE SPLICE

Splice the remaining single strands for 2 more full tucks, tape and cut off as shown in Fig. F.

Trim last tucked strands so all exposed strands are similar in length after their final tuck.

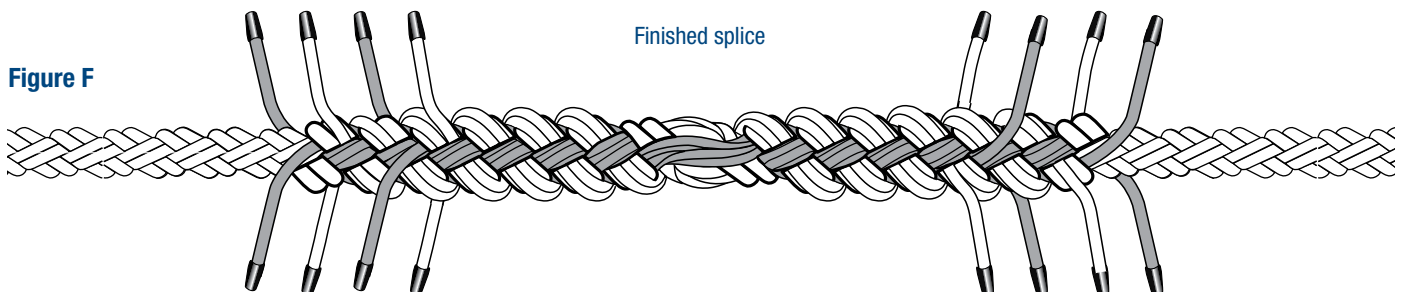

8-Strand Class I Eye Splice

Class I ropes are made from any or all of the following fibers: olefin, polyester, or nylon.

The eye splice is used to place a permanent loop in the end of a rope, generally for attachment purposes to a fixed point. An eye is also used to form the rope around a thimble, which is used to protect the rope, especially when it is to be attached to a shackle, chain, or wire rope.

GETTING STARTED

8-strand ropes, also known as plaited ropes, are composed of 8 strands grouped into 4 pairs. 2 of these pairs turn to the left (shown in gray), and 2 pairs turn to the right (shown in white.) Seen in this cross-section, the 4 strand pairs form the sides of a square. The strands that are on opposite sides of the square will rotate in the same direction.

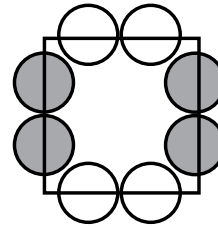

TOOLS REQUIRED

A splicing fid or marlinspike, sharp knife or scissors, plastic or masking tape, marking pen.

STEP 1 COUNTING AND MARKING

From the end of the rope, count a distance of 10 picks and apply tape securely around the rope immediately after the 10th pick, as shown in the illustration. This is Mark 1. Apply the tape securely enough so that it will not move during the splicing procedure.

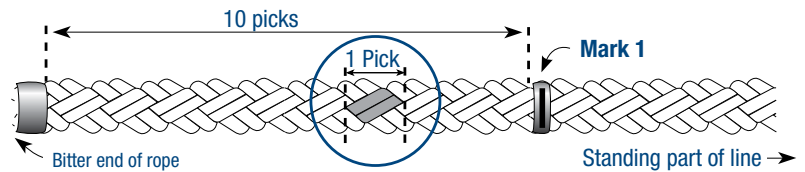

STEP 2 MAKING THE EYE AND MARKING THE ROPE

Form the desired size of the eye being careful not to add twist to the rope. Mark the rope adjacent to the tape. This is Mark 2.

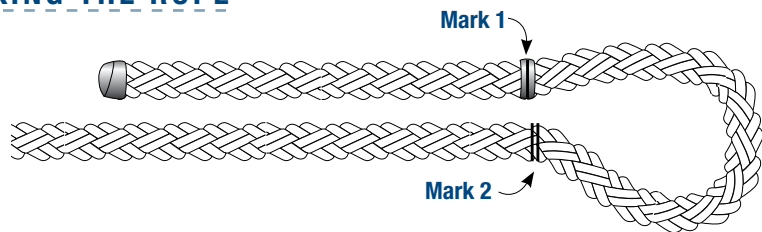

STEP 3 MARKING THE LEFT-ROTATING STRANDS

From the end of the rope; mark the first 10-picks up to the tape at Mark 1. Continue marking the length of the eye and at least an additional 6 picks past Mark 2. Mark all strands that rotate left on both sides of the braided rope.

Note: The strands that rotate left (gray) can be marked for improved visual reference. 8-strand ropes are composed of 4 pairs of 2 strands each. 2 of the strand pairs rotate to the left, and 2 pairs rotate to the right. When marking the left-rotating strands, be sure to turn the rope over and mark the left-rotating strands on the opposite side of the braid.

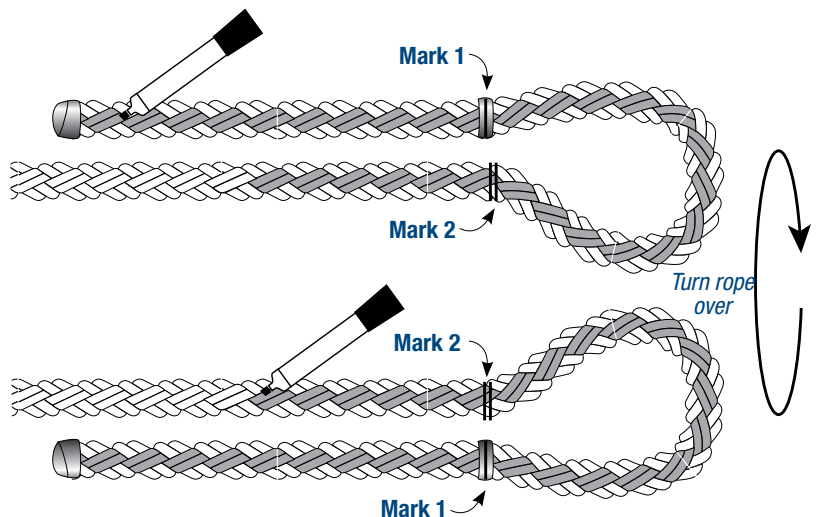



8-Strand Class I Eye Splice

STEP 4 TAPING THE ENDS AND UNLAYING THE ROPE

4A Tape the ends of each of the 8 strands individually.

4B Unlay the strand pairs all the way back to the tape at Mark 1. Keep the pairs of strands together while unbraiding.

4C When unlayed, the strands in a pair will be twisted around each other. Untwist each strand pair so the 2 strands lie parallel to each other, rather than twisting around each other. Tape the ends of each pair together.

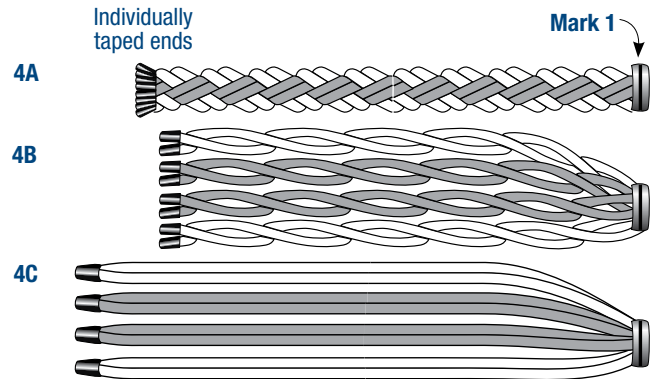

STEP 5 POSITIONING THE STRANDS

Arrange the strand pairs as shown in Fig. A. One set of the marked (gray) strands is on the top; and the other marked (gray) strands are on the bottom. The unmarked (white) pair will be on the left and right.

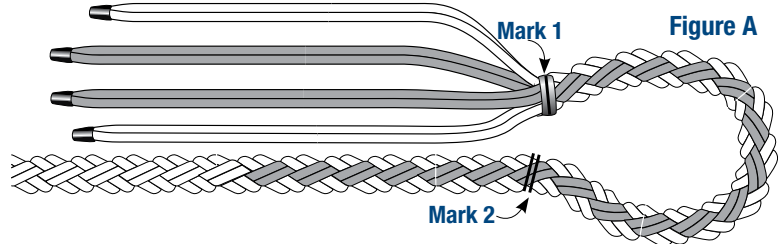

STEP 6 FORMING THE EYE

Physically form the eye, making certain there is no twist in the rope. Place the (white) pair that is closest to the standing part of the rope over the rope, at Mark 2, as shown in Fig. B; being careful not to add twist to the rope.

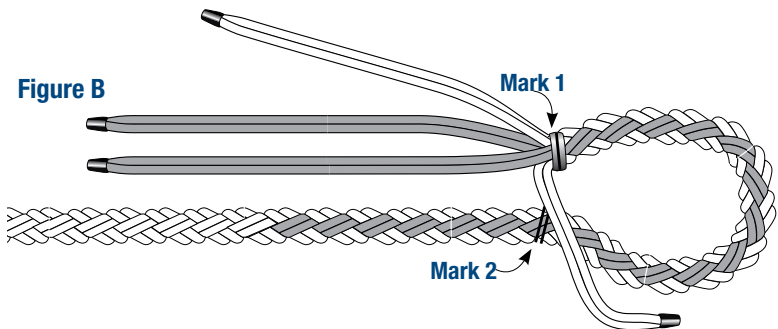

STEP 7 ROUTE TUCKING THE STRAND PAIRS

Note: If necessary, use a fid or marlinspike to loosen the strands. The left rotating (gray) strands will be tucked under the right rotating (white) strands, and vice versa.

7A Beginning with the left rotating marked (gray) pair of strands on top, make your first tuck under the right rotating (white) pair of strands closest to Mark 2. Pull the strands completely through, making sure that the strands don't twist (Fig. C).

7B Turn the eye over and tuck the other marked (gray) pair of strands under the (white) pair of strands directly opposite the previous tuck (Fig. D).

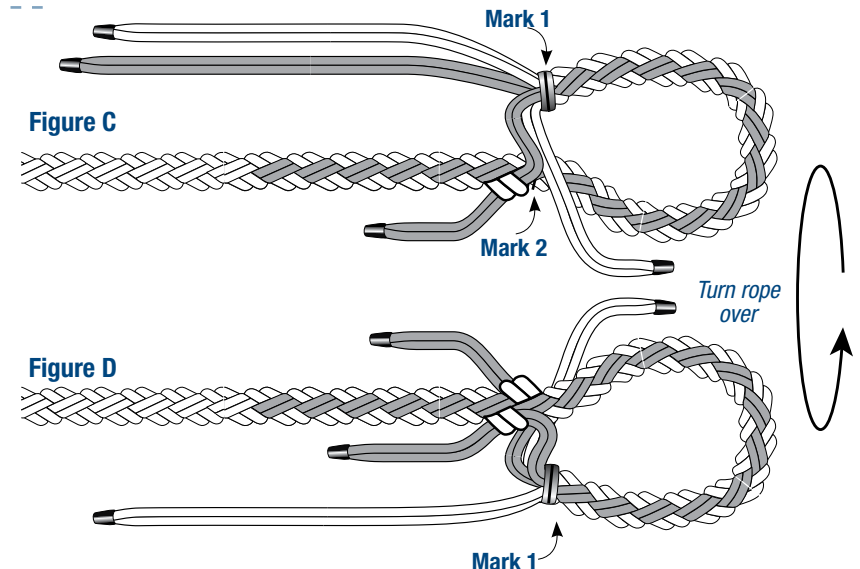



8-Strand Class I Eye Splice

7C Tuck the (white) pair of strands under the (gray) pair of strands closest to the first 2 tucks. Pull the strands snug, but not tight to avoid distorting the strands in the eye area. Again, make sure there is no twist in the strands (Fig. E).

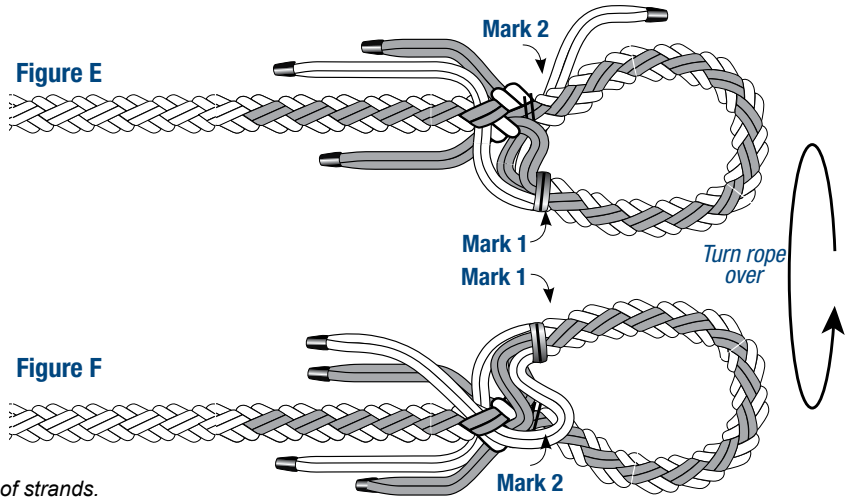

7D Turn the eye over and tuck the remaining (white) pair of strands under the remaining (gray) pair of strands in the standing part of the rope (Fig. F).

Note: A full tuck includes all 4 pairs of strands.

7E Remove tape and pull all 8 strands snug and correct any twist that may have been introduced during the tucking procedure. The first tuck is now complete (Fig. G).

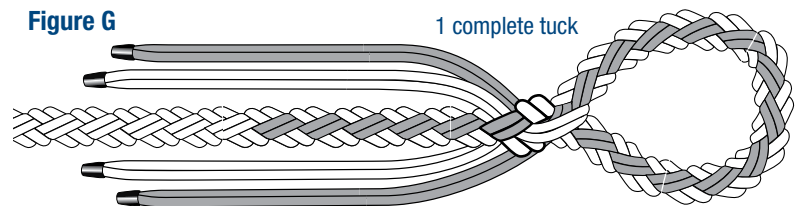

STEP 8 COMPLETING THE TUCKS AND FINISHING THE SPLICE

8A Continue tucking the (gray) strands under the (white) strands and the (white) strands under the (gray) strands until at least 4 full tucks (with all 4 strand pairs) have been completed.

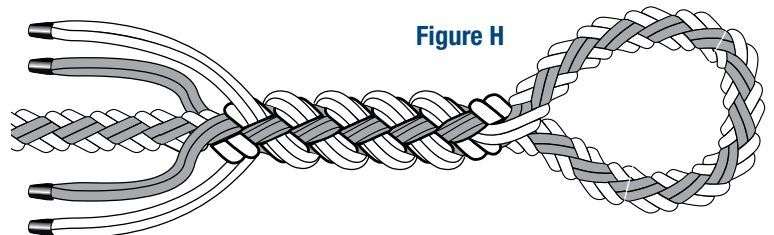

8B After each round of tucks, pull each strand to make sure they are snug and there is no twist. The splice should look like Fig. H.

8C Locate the strand closest to the eye in each strand pair. Tape and cut off, leaving enough of the end protruding so it does not slip back into the rope when loaded. The splice should look like Fig. I.

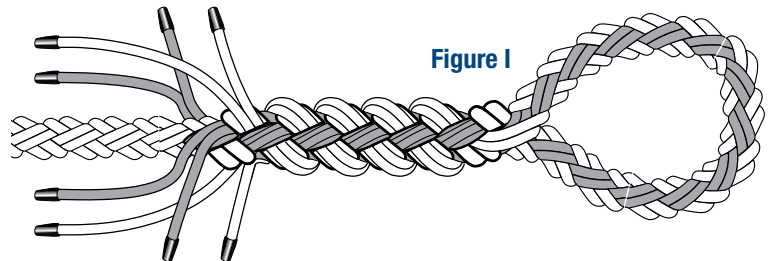

8D Continue tucking the remaining strands, with the (gray) strands under the (white) strands, and vice versa, for 2 more full tucks.

8E Tape and cut off the remaining strands. The finished splice should look like Fig. J.

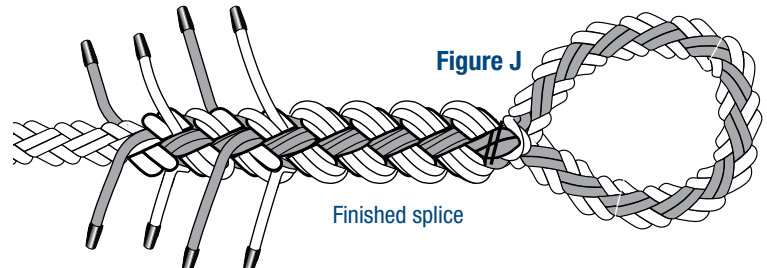

Note: The 8 ends can be heat fused so they don't fray, but be careful not to damage any of the strands.



8-Strand Class II End-For-End Splice

Class II ropes are made in whole or part from any of the following high modulus fibers: Dyneema®, Vectran®, Technora®, and Zylon®.

GETTING STARTED

8-strand ropes, also known as plaited ropes, are composed of 8 strands grouped into 4 pairs. 2 of these pairs turn to the left (shown in gray), and 2 pairs turn to the right (shown in white.) Seen in this cross-section, the 4 strand pairs form the sides of a square. The strands that are on opposite sides of the square will rotate in the same direction.

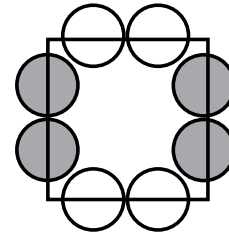

TOOLS REQUIRED

A splicing fid or marlinspike, sharp knife or scissors, plastic or masking tape, marking pen.

STEP 1 COUNTING AND MARKING

From the end of the rope, count a distance of 16 picks and apply tape securely around the rope immediately after the 16th pick, as shown in the illustration. This is Mark 1. Apply the tape securely enough so that it will not move during the splicing procedure.

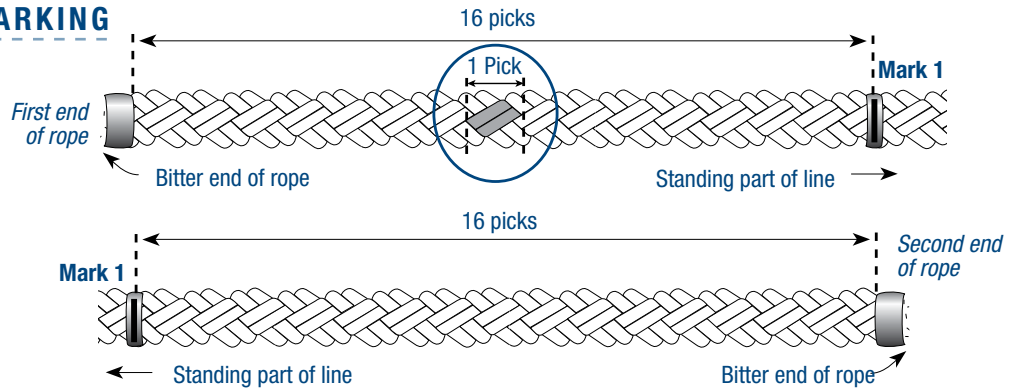

STEP 2 MARKING THE ROPE

Holding the end of the rope, note the pairs of strands going to the left. Mark these pairs. Mark the strands up to Mark 1 and continue to mark the strands for 5 or more picks beyond Mark 1.

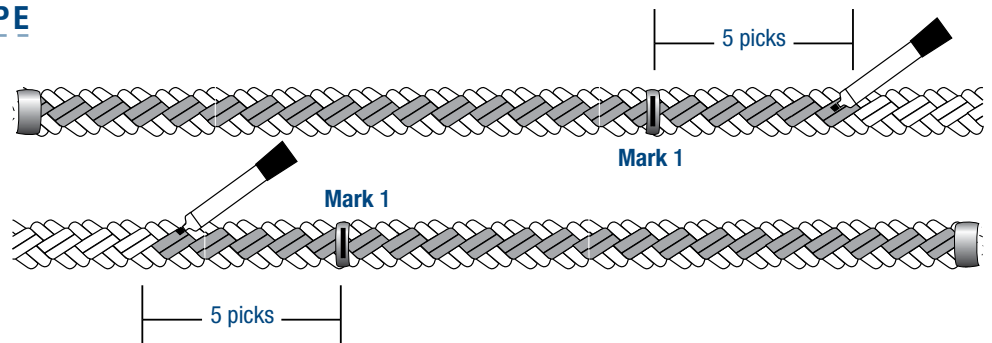

STEP 3 SEPARATING & TAPING

Remove tape from end then tape the end of each strand. Start unlaying strands in their respective pairs. It is important to keep them together. After they are separated into pairs up to Mark 1, untwist the pairs. Tape the ends of pairs together with a taper as shown.

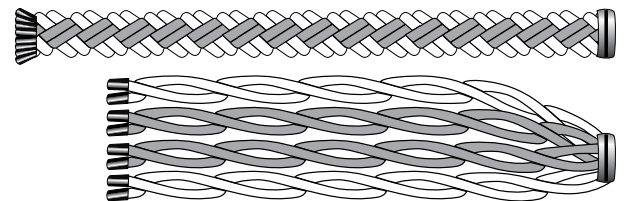

3A Lay out rope as shown in Fig. A. Working from the right hand rope. Unmarked strand pairs are shown in white. Marked strand pairs are shown in gray. The left hand rope mirrors this arrangement.

Pairs taped together

Figure A

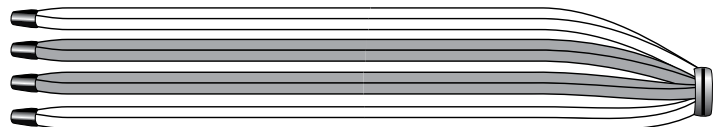



8-Strand Class II End-For-End Splice

STEP 4 JOINING THE PAIRS

To start, lay out the marked and unmarked strands as they appear in Fig. B.

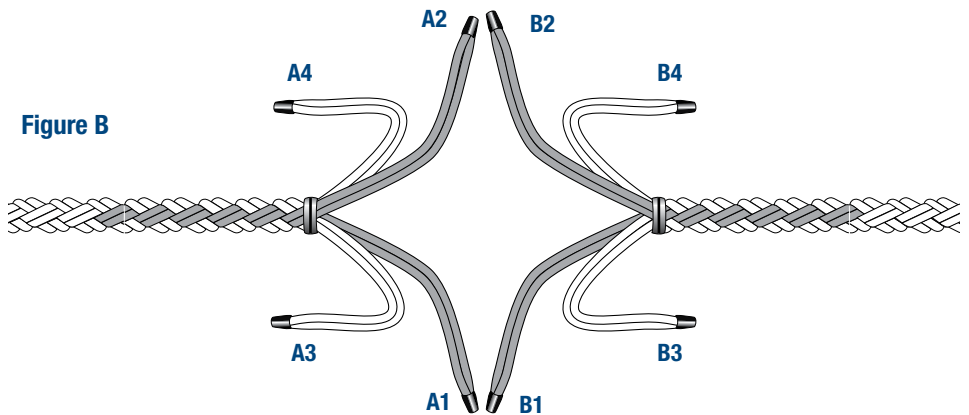

4A

It is important that the next steps of the procedure be followed carefully as shown in Fig. C.

Marked A1 strands go through marked B1 strands. Marked B2 strands go through marked A2 strands.

Unmarked A3 strands go through unmarked B3 strands.

Unmarked B4 strands go through unmarked A4 strands. Keep strands untwisted.

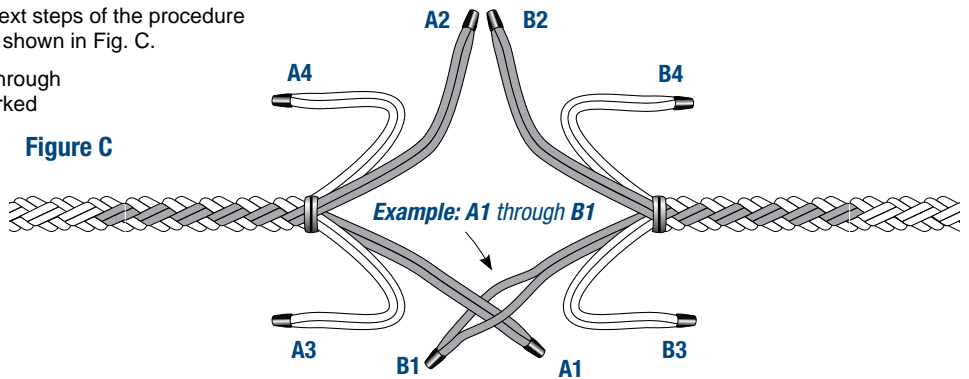

STEP 5 MARRYING THE ROPES

After the initial step has been completed on all strands, you should have something that looks like Fig. D. Marry the ropes as shown in Step 6. This part is preferably a 2-person job.

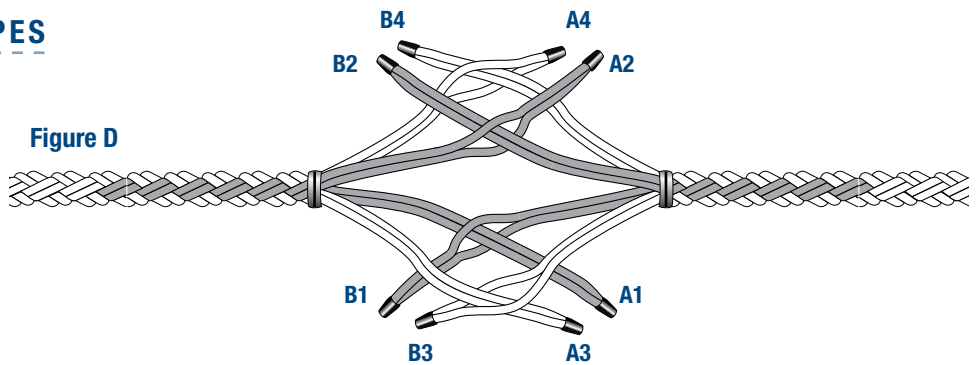

STEP 6 FINISHING MARRIAGE

Keep the ropes together snugly. Tie a piece of string tightly around the splicing point as shown in Fig. E. Remove both pieces of tape from the rope.

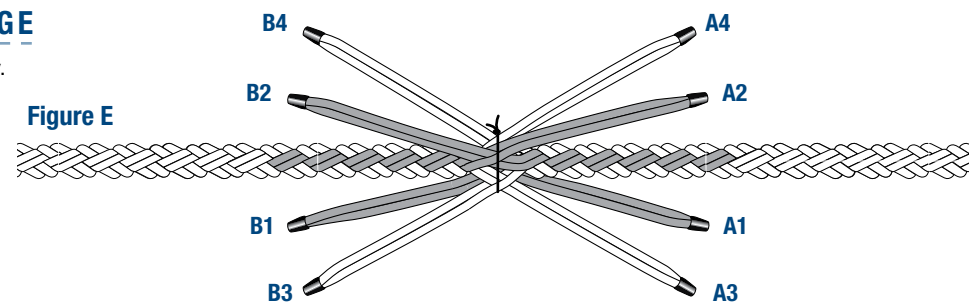



8-Strand Class II End-For-End Splice

STEP 7 STARTING THE TUCKS

Beginning at the marriage, tuck a marked pair of strands under the nearest unmarked pair. Then tuck an unmarked pair under the nearest marked pair of strands.

Complete 1 full set of tucks tuck in one direction with all the strands and then do another full set of tucks on the other side of the marriage. Pull everything tight before proceeding.

Continue tucking the strands around the rope until you have completed 6 full tucks on each side of the marriage with all the strand pairs. Next, select the strand closest to the marriage point in each pair. Tape this strand and cut the excess off as shown.

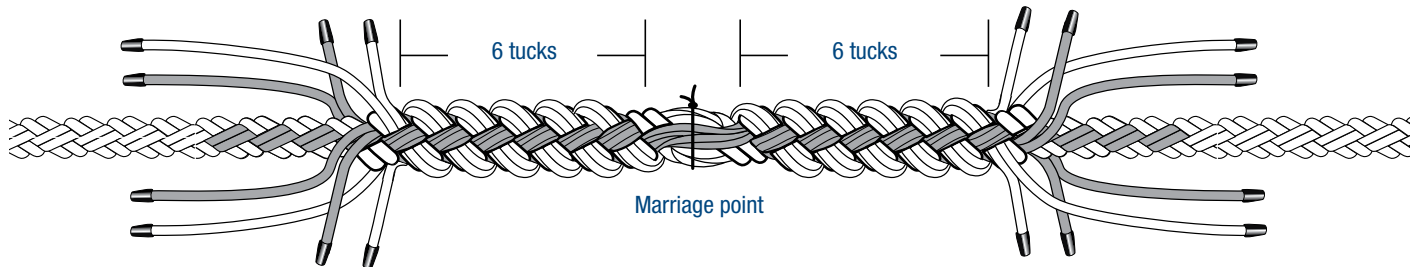

STEP 8 CONTINUING TUCKS

Splice the remaining single strands for 3 more full tucks.

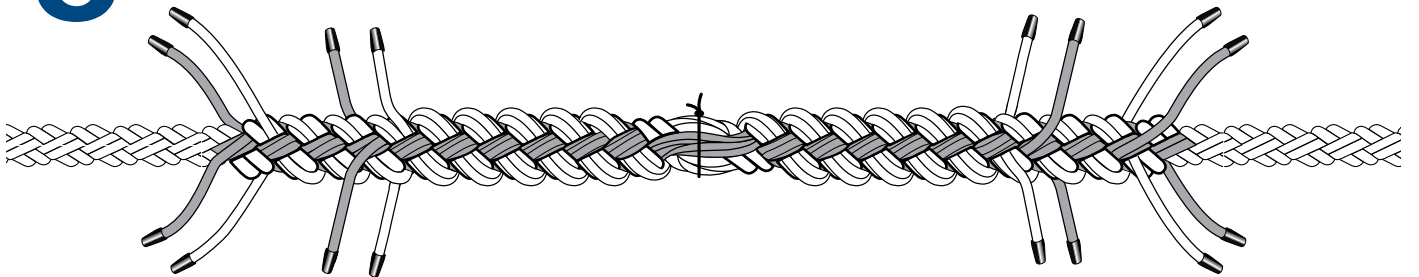

STEP 9 FINISHING THE SPLICE

9A The tapering process continues by reducing the volume of each remaining strand by half (count the number of yarns that comprise each strand and divide as evenly as possible.) Select the divided half of each of the 4 strand yarns on each end of the splice.

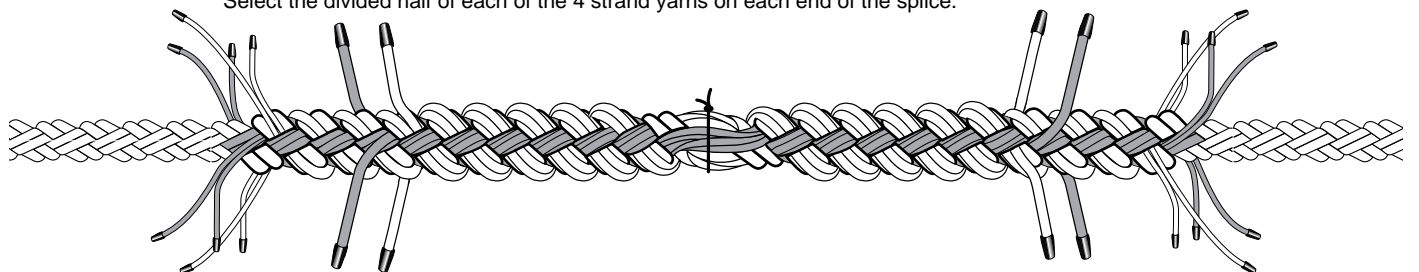

9B With the remaining 4 half-volume single strands on each side of the splice, perform 3 full tucks. Tape the strands after they have been tucked and cut them off as done with previous strands.

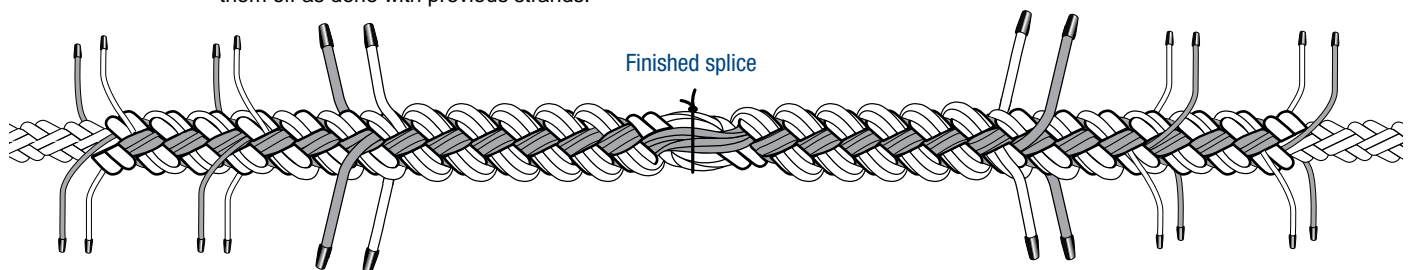

8-Strand Class II Eye Splice

Class II ropes are made in whole or part from any of the following high modulus fibers: Dyneema®, Vectran®, Technora®, and Zylon®.

The eye splice is used to place a permanent loop in the end of a rope, generally for attachment purposes to a fixed point. An eye is also used to form the rope around a thimble, which is used to protect the rope, especially when it is to be attached to a shackle, chain, or wire rope.

GETTING STARTED

8-strand ropes, also known as plaited ropes, are composed of 8 strands grouped into 4 pairs. 2 of these pairs turn to the left (shown in gray), and 2 pairs turn to the right (shown in white.) Seen in this cross section, the 4 strand pairs form the sides of a square. The strands that are on opposite sides of the square will rotate in the same direction.

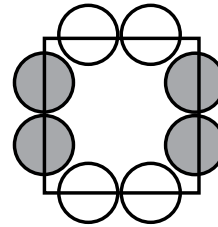

TOOLS REQUIRED

A splicing fid or marlinspike, sharp knife or scissors, plastic or masking tape, marking pen.

STEP 1 COUNTING AND MARKING

From the end of the rope, count a distance of 16 picks and apply tape securely around the rope immediately after the 16th pick, as shown in the illustration. This is Mark 1. Apply the tape securely enough so that it will not move during the splicing procedure.

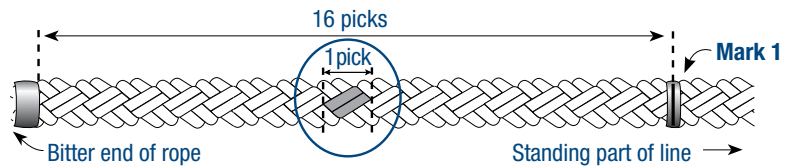

STEP 2 MAKING THE EYE AND MARKING THE ROPE

Form the desired size of the eye, being careful not to add twist to the rope. Mark the rope adjacent to the tape. This will be Mark 2.

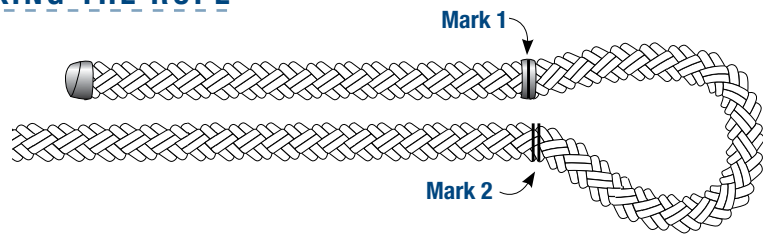

STEP 3 MARKING THE LEFT-ROTATING STRANDS

From the end of the rope, mark the first 16 picks up to the tape at Mark 1. Continue marking the length of the eye and at least an additional 6 picks past Mark 2. Mark all strands that rotate left on both sides of the braided rope.

Note: The strands that rotate left (gray) can be marked for improved visual reference. 8-strand ropes are composed of 4 pairs of 2 strands each. 2 of the strand pairs rotate to the left, and 2 pairs rotate to the right. When marking the left-rotating strands, be sure to turn the rope over and continue to mark the left-rotating strands on the opposite side of the braid.

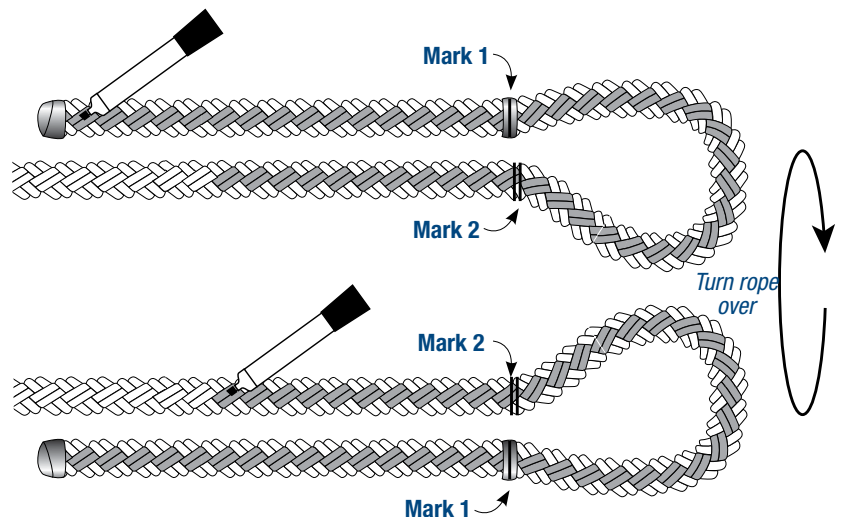

8-Strand Class II Eye Splice

STEP 4 TAPING THE ENDS AND UNLAYING THE ROPE

4A Tape the ends of each of the 8 strands individually.

4B Unlay the strand pairs all the way back to the tape at Mark 1. Keep the pairs of strands together while unbraiding.

4C When unlayed, the strands in a pair will be twisted around each other. Untwist each strand pair so the 2 strands lie parallel to each other, rather than twisting around each other. Tape the ends of each pair together.

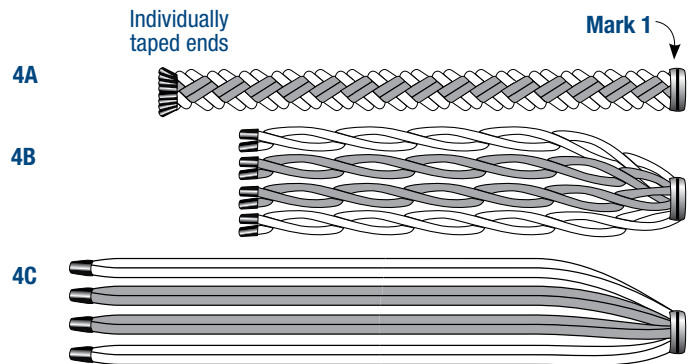

STEP 5 POSITIONING THE STRANDS

Arrange the strand pairs as shown in Fig. A. One set of the marked (gray) strands is on the top and the other marked (gray) strands are on the bottom. The unmarked (white) pair will be on the left and right.

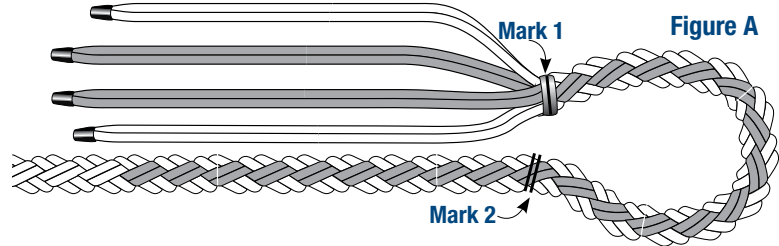

STEP 6 FORMING THE EYE

Physically form the eye. Make certain there is no twist in the rope. Place the (white) pair that is closest to the standing part of the rope over the rope at Mark 2, as shown in Fig. B; be careful not to add twist to the rope.

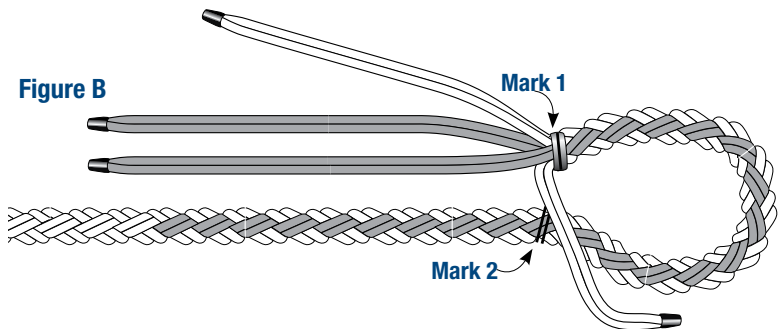

STEP 7 ROUTE TUCKING THE STRAND PAIRS

Note: If necessary, use a fid or marlinspike to loosen the strands. The left rotating (gray) strands will be tucked under the right rotating (white) strands, and vice versa.

7A Beginning with the left rotating marked (gray) pair of strands on top, make your first tuck under the right rotating (white) pair of strands closest to Mark 2. Pull the strands completely through, making sure that the strands don't twist (Fig. C).

7B Turn the eye over and tuck the other marked (gray) pair of strands under the (white) pair of strands directly opposite the previous tuck (Fig. D).

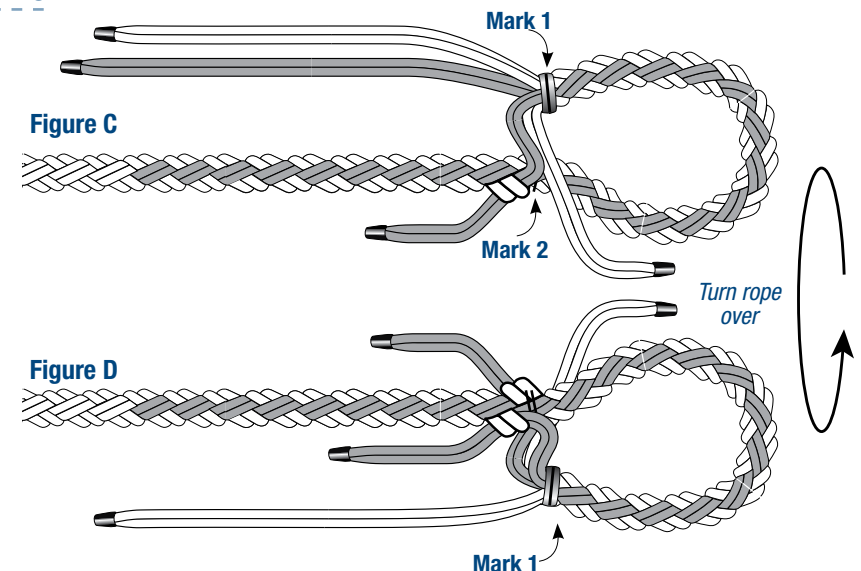



8-Strand Class II Eye Splice

7C Tuck the (white) pair of strands under the (gray) pair of strands closest to the first 2 tucks. Pull the strands snug, but not tight to avoid distorting the strands in the eye area. Again, make sure there is no twist in the strands (Fig. E).

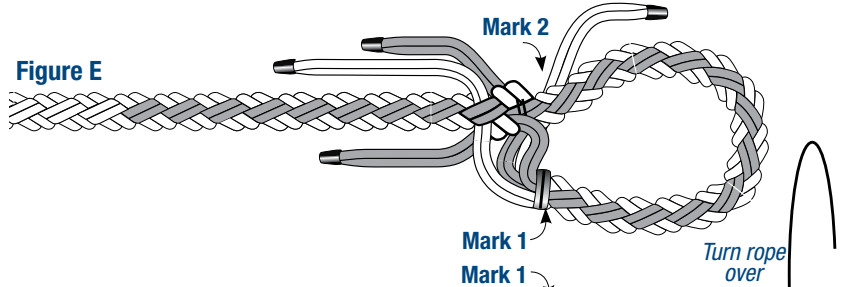

7D Turn the eye over and tuck the remaining (white) pair of strands under the remaining (gray) pair of strands in the standing part of the rope (Fig. F).

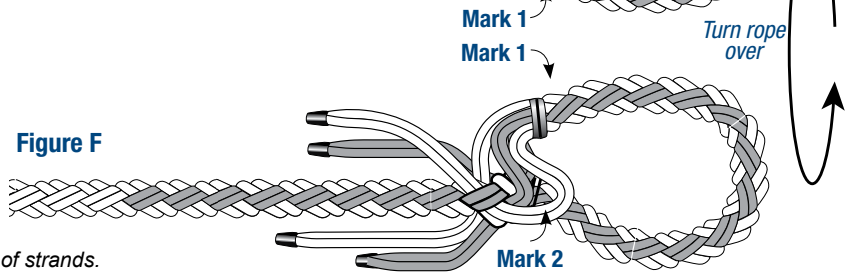

Note: A full tuck includes all 4 pairs of strands.

7E Remove tape and pull all 8 strands snug and correct any twist that may have been introduced during the tucking procedure. The first tuck is now complete (Fig. G).

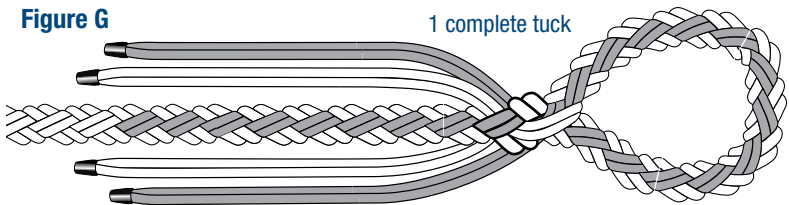

STEP 8 COMPLETING THE TUCKS AND FINISHING THE SPLICE

8A Continue tucking the (gray) strands under the (white) strands and the (white) strands under the (gray) strands until at least 6 full tucks (with all 4 strand pairs) have been completed.

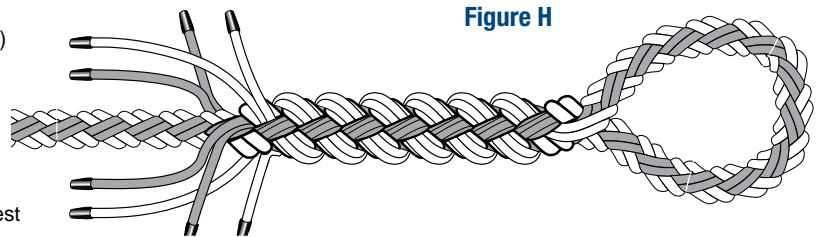

8B After each round of tucks, pull each strand to make sure they are snug and there is no twist. Locate the strand closest to the eye in each strand pair. Tape and cut off, leaving enough protruding so the end does not slip back into the rope when loaded. The splice should look like Fig. H.

8C Continue tucking the remaining strands 3 full tucks. The splice should look like Fig. I.

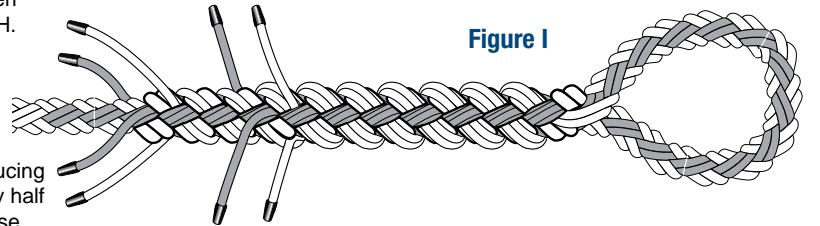

8D The tapering process continues by reducing the volume of each remaining strand by half (count the number of yarns that comprise each strand and divide as evenly as possible.) Select the divided half of each of the 4 strand yarns closest to the eye. Tape and cut off.

8E With the remaining 4 half-volume single strands, perform 3 full tucks. Tape the strands after they have been tucked and cut them off as done with previous strands. The completed splice should look like Fig. J.

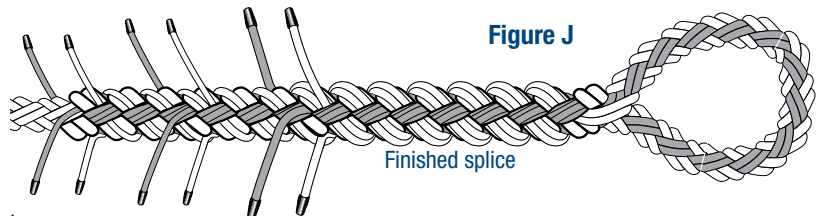

Note: The 8 ends can be heat fused so they don't fray, but be careful not to damage any of the strands.



8x3-Strand Class II End-For-End Splice

Class II construction ropes are made in whole or part from any of the following high modulus fibers: Dyneema®, Vectran®, Technora®, and Zylon®.

GETTING STARTED

8-strand ropes, also known as plaited ropes, are composed of 8 strands grouped into 4 pairs. 2 of these pairs turn to the left (shown in gray), and 2 pairs turn to the right (shown in white.) Seen in this cross-section, the 4 strand pairs form the sides of a square. The strands that are on opposite sides of the square will rotate in the same direction.

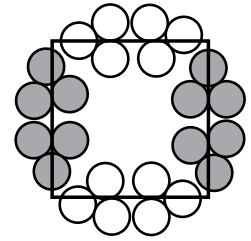

TOOLS REQUIRED

A splicing fid or marlinspike, sharp knife or scissors, plastic or masking tape, marking pen.

STEP 1 COUNTING AND MARKING

From the end of the rope, count a distance of 16 picks and apply tape securely around the rope immediately after the 16th pick, as shown in the illustration. This is Mark 1. Apply the tape securely enough so that it will not move during the splicing procedure.

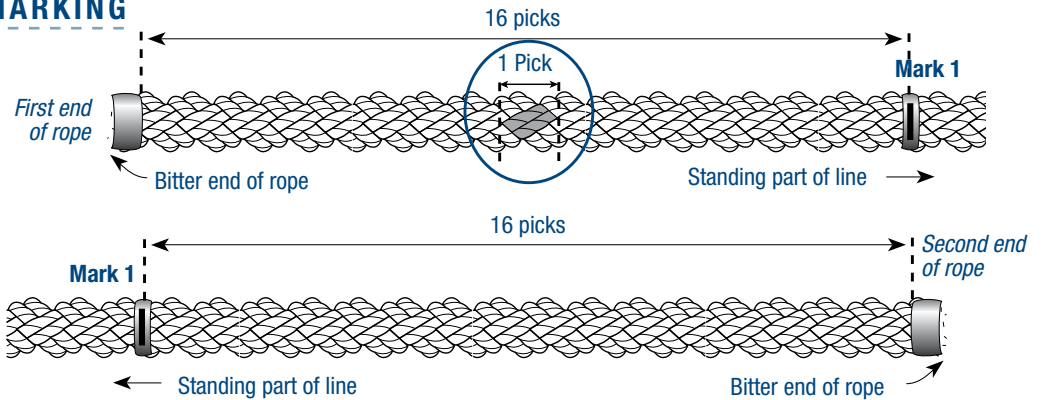

STEP 2 MARKING THE ROPE

Holding the end of the rope, note the pairs of strands going to the left. Mark these pairs. Mark the strands up to Mark 1 and continue to mark the strands for 5 or more picks beyond the Mark 1.

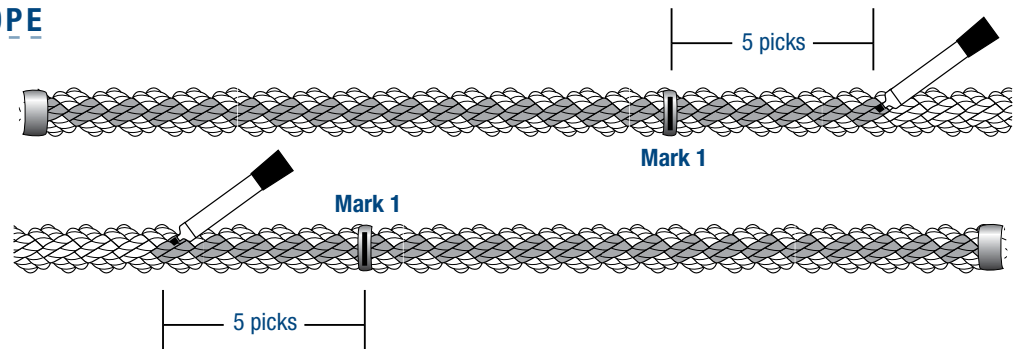

STEP 3 SEPARATING & TAPING

Remove tape from end then tape the end of each strand. Start unlaying strands in their respective pairs. It is important to keep them together. After they are separated into pairs up to Mark 1, untwist the pairs. Tape the ends of pairs together with a taper as shown as shown in Fig. A.

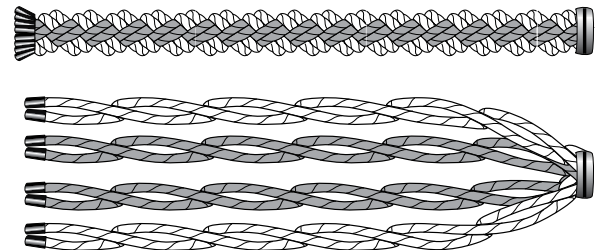

3A Lay out rope as shown in as shown in Fig. A, working from the right hand rope. Unmarked strand pairs are shown in white. Marked strand pairs are shown in gray. The left hand rope mirrors this arrangement.

Pairs taped together

Figure A

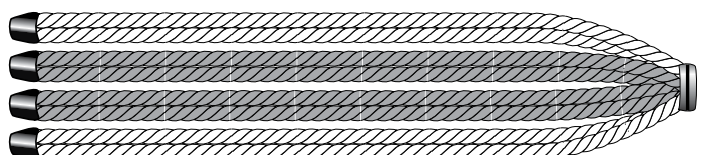



8x3-Strand Class II End-For-End Splice

STEP 4 JOINING THE PAIRS

To start, lay out the marked and unmarked strands as they appear in Fig. B.

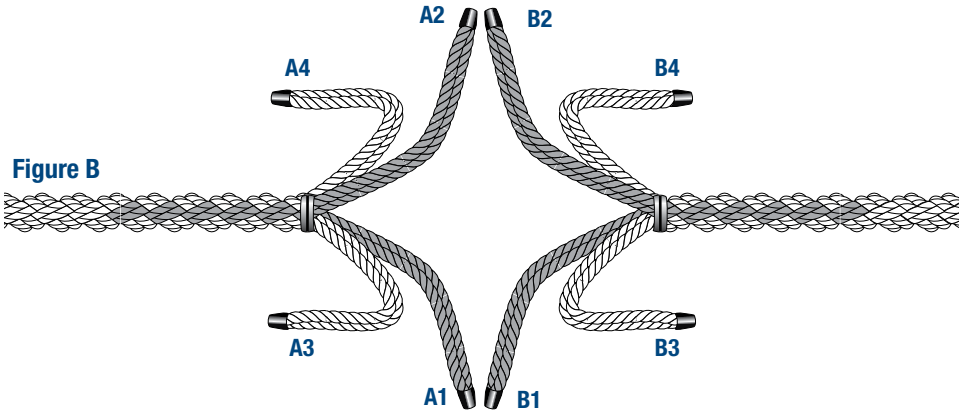

Figure B

4A

It is important that the next steps of the procedure be followed carefully as shown in Fig. C.

Marked A1 strands go through marked B1 strands.

Marked B2 strands go through marked A2 strands.

Unmarked A3 strands go through unmarked B3 strands.

Unmarked B4 strands go through unmarked A4 strands. Keep strands untwisted.

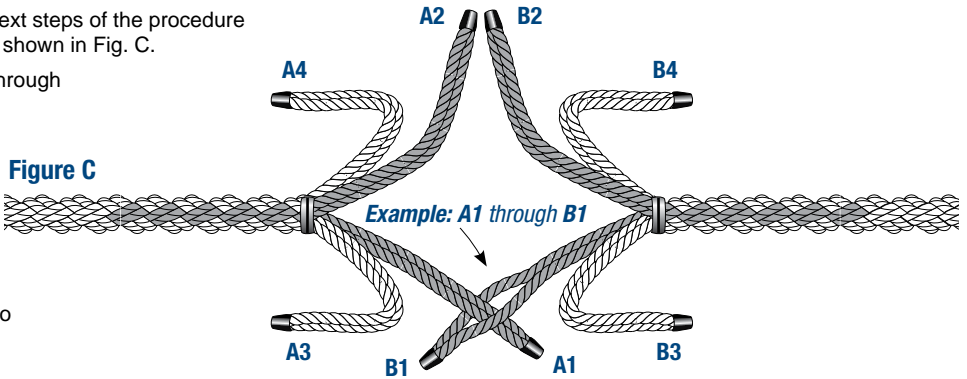

Figure C

STEP 5 MARRYING THE ROPES

After the initial step has been completed on all strands, you should have something that looks like Fig. D. Marry the ropes as shown in Step 6. This part is preferably a 2-person job.

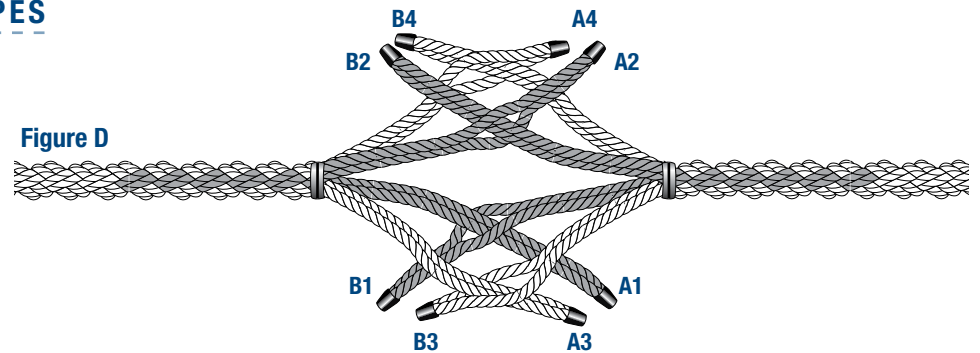

Figure D

STEP 6 FINISHING MARRIAGE

Keep the ropes together snugly. Tie a piece of string tightly around the splicing point as shown in Fig. E. Remove both pieces of tape from the rope.

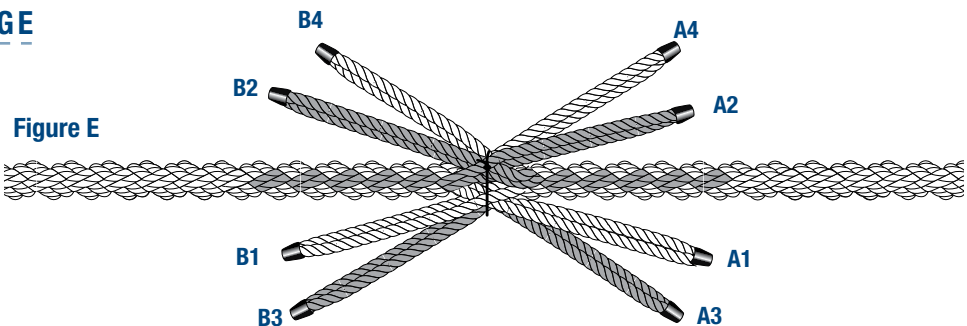

Figure E



8x3-Strand Class II End-For-End Splice

STEP 7 STARTING THE TUCKS

7A Beginning at the marriage, tuck a marked pair of strands under the nearest unmarked pair. Then tuck an unmarked pair under the nearest marked pair of strands.

Complete 1 full set of tucks tuck in one direction with all the strands and then do another full set of tucks on the other side of the marriage. Pull everything tight before proceeding.

Continue tucking the strands around the rope until you have completed 6 full tucks on each side of the marriage with all the strand pairs.

Having completed 6 full tucks for each pair of strands you will need to reduce the strand volume by 1/3 before continuing to the next set of tucks. To do this, cut 1 of the 3 strands out of each pair as shown in Fig. F.

Figure F

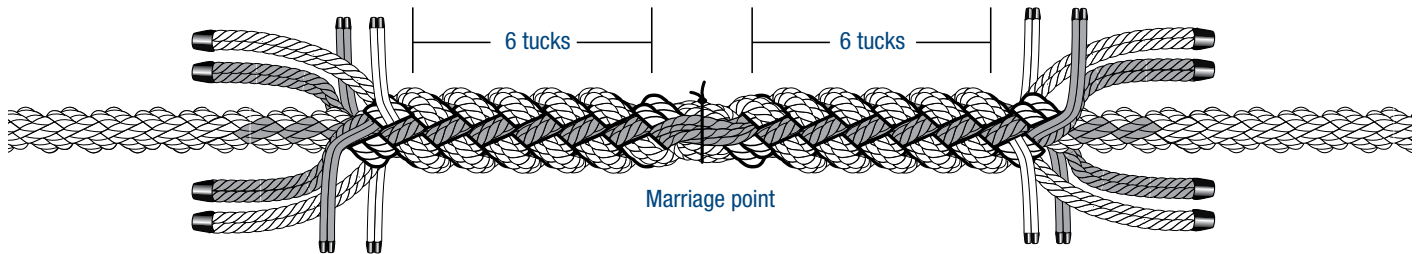
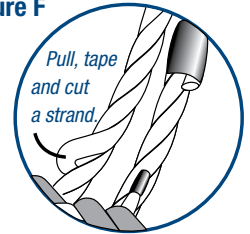

7B Continue tucking the remaining strands, with the (gray) strands under the (white) strands, and vice versa, for 3 more full tucks. Reduce the volume of each of the strands in the 4 pairs of strands, by 1/2 (Do this by removing 1 of the 2 strands in each of the remaining pairs.) The splice should look like Fig. G.

Figure G

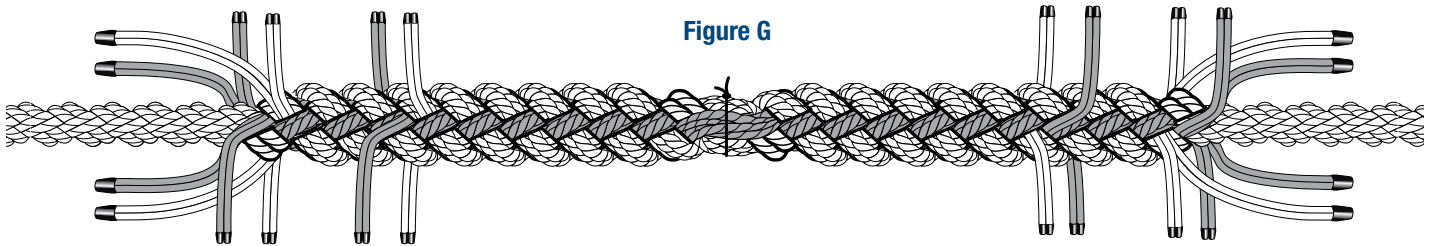

STEP 8 CONTINUING TUCKS

Continue tucking the remaining strands for 3 more full tucks. Tape and cut off the remaining strands, the finished splice should look like Fig. H.

Figure H

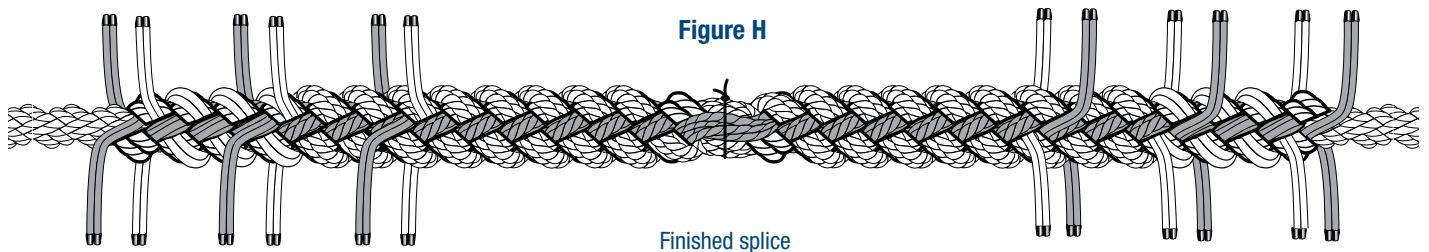

8x3-Strand Class II Eye Splice

Class II ropes are made in whole or part from any of the following high modulus fibers: Dyneema®, Vectran®, Technora®, and Zylon®.

The eye splice is used to place a permanent loop in the end of a rope, generally for attachment purposes to a fixed point. An eye is also used to form the rope around a thimble, which is used to protect the rope, especially when it is to be attached to a shackle, chain, or wire rope.

GETTING STARTED

8-strand ropes, also known as plaited ropes, are composed of 8 strands grouped into 4 pairs. 2 of these pairs turn to the left (shown in gray), and 2 pairs turn to the right (shown in white.) Seen in cross section, the 4 strand pairs form the sides of a square. The strands that are on opposite sides of the square will rotate in the same direction.

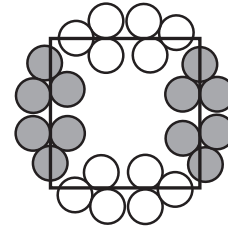

TOOLS REQUIRED

A splicing fid or marlinspike, sharp knife or scissors, plastic or masking tape, marking pen.

STEP 1 COUNTING AND MARKING

From the end of the rope, count a distance of 16 picks and apply tape securely around the rope immediately after the 16th pick, as shown in the illustration. This is Mark 1. Apply the tape securely enough so that it will not move during the splicing procedure.

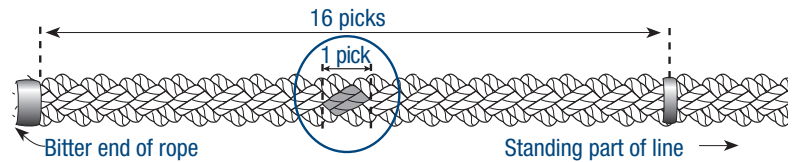

STEP 2 MAKING THE EYE AND MARKING THE ROPE

Form the desired size of the eye, being careful not to add twist to the rope. Mark the rope adjacent to the tape. This is Mark 2.

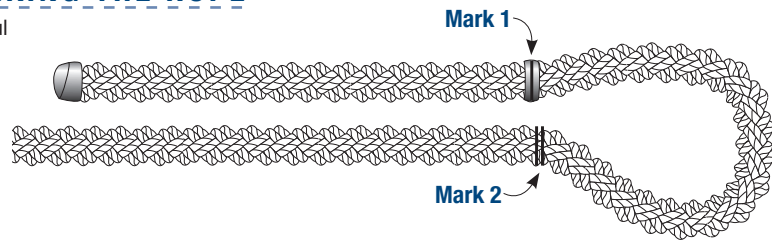

STEP 3 MARKING THE LEFT-ROTATING STRANDS

From the end of the rope; mark the first 16 picks up to the tape at Mark 1 continue marking the length of the eye and at least an additional 6 picks past Mark 2. Mark all strands that rotate left on both sides of the braided rope.

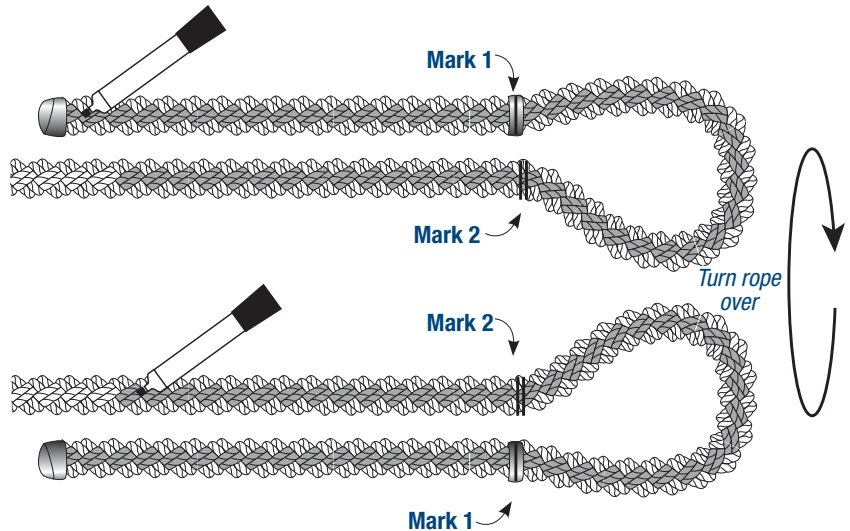

Note: The strands that rotate left (gray) can be marked for improved visual reference. 8-strand ropes are composed of 4 pairs of 2 strands each. 2 of the strand pairs rotate to the left, and 2 pairs rotate to the right. When marking the left-rotating strands, be sure to turn the rope over and mark the left-rotating strands on the opposite side of the braid.

8x3-Strand Class II Eye Splice

STEP 4 TAPING THE ENDS AND UNLAYING THE ROPE

4A Tape the ends of each of the 8 strands individually.

4B Unlay the strand pairs all the way back to the tape at Mark 1. Keep the pairs of strands together while unbraiding.

4C When unlayed, the strands in a pair will be twisted around each other. Untwist each strand pair so the 2 strands lie parallel to each other rather than twisting around each other. Tape the ends of each pair together.

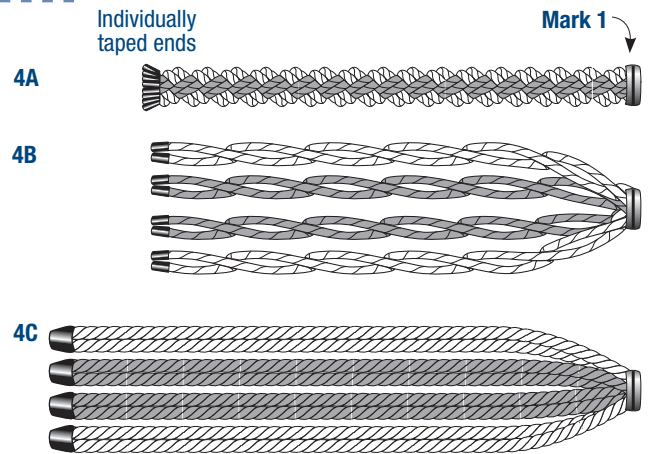

STEP 5 POSITIONING THE STRANDS

Arrange the strand pairs as shown in Fig. A. One set of the marked (gray) strands is on the top; and the other marked (gray) strands are on the bottom. The unmarked (white) pair will be on the left and right.

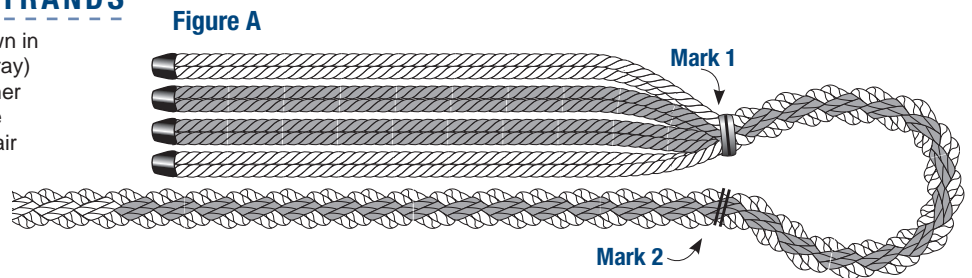

STEP 6 FORMING THE EYE

Physically form the eye, making certain there is no twist in the rope. Place the (white) pair that is closest to the standing part of the rope over the rope, at Mark 2, as shown in Fig. B. Be careful not to add twist to the rope.

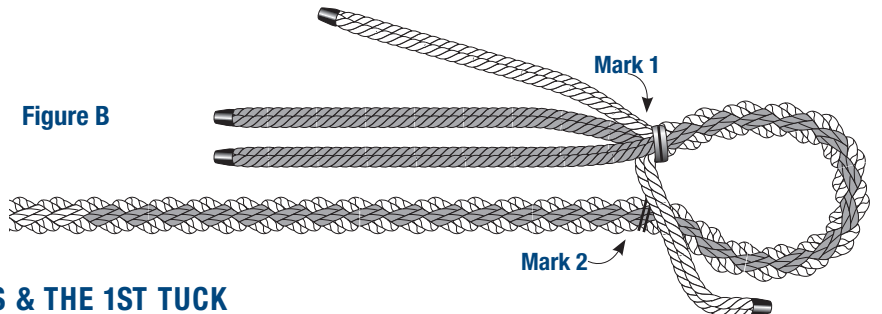

STEP 7 ROUTING THE STRAND PAIRS & THE 1ST TUCK

Note: If necessary, use a fid or marlinspike to loosen the strands. The left rotating (gray) strands will be tucked under the right rotating (white) strands, and vice versa.

7A Beginning with the left rotating marked (gray) pair of strands on top, make your first tuck under the right rotating (white) pair of strands closest to Mark 2. Pull the strands completely through, making sure that the strands don't twist (Fig. C).

7B Turn the eye over and tuck the other marked (gray) pair of strands under the (white) pair of strands directly opposite the previous tuck (Fig. D).

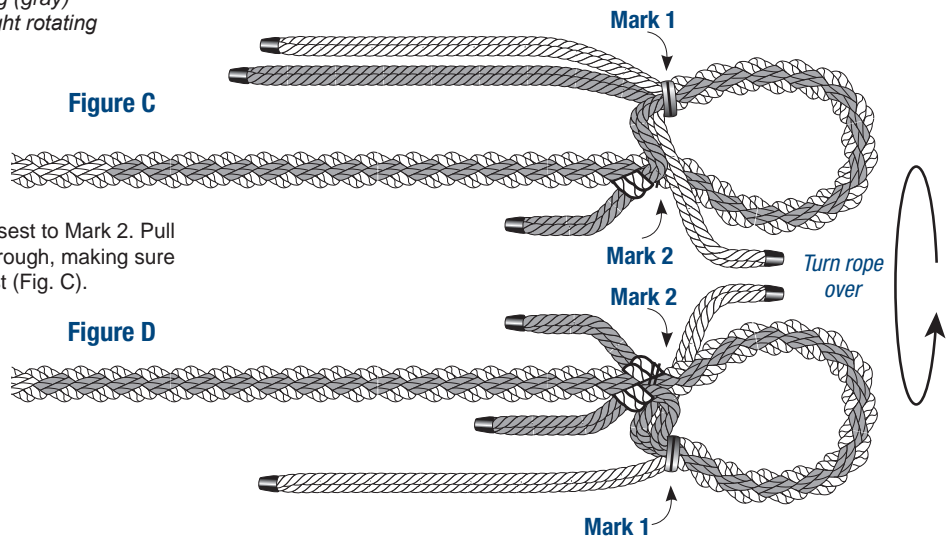



8x3-Strand Class II Eye Splice

7C Tuck the (white) pair of strands under the (gray) pair of strands closest to the first 2 tucks. Pull the strands snug, but not tight to avoid distorting the strands in the eye area. Again, make sure there is no twist in the strands (Fig. E).

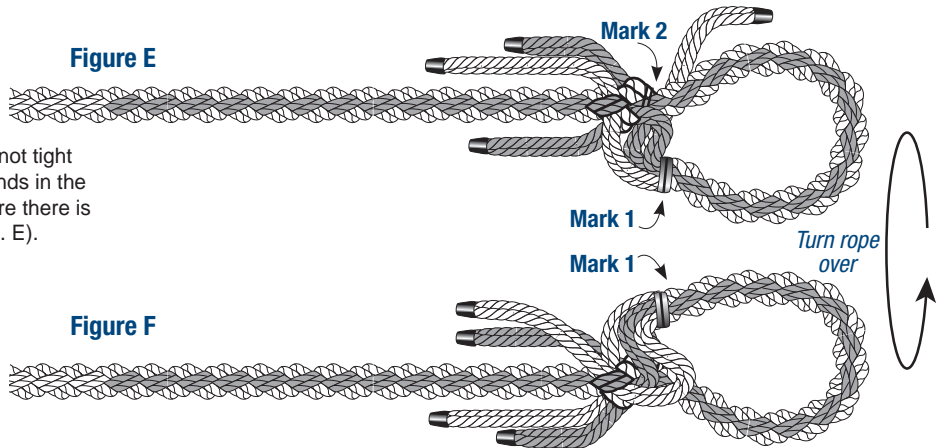

7D Turn the eye over and tuck the remaining (white) pair of strands under the remaining (gray) pair of strands in the standing part of the rope (Fig. F).

Note: A full tuck includes all 4 pairs of strands.

7E Remove tape and pull all 8 strands snug and correct any twist that may have been introduced during the tucking procedure. The first tuck is now complete (Fig. G).

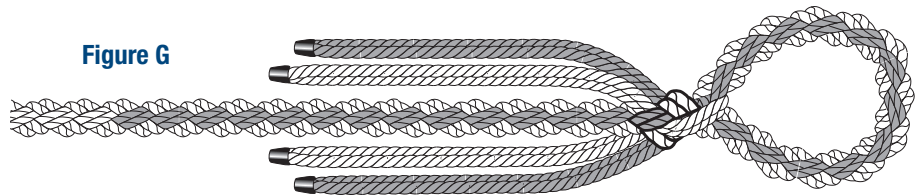

STEP 8 COMPLETING THE TUCKS AND FINISHING THE SPLICE

8A Continue tucking the (gray) strands under the (white) strands and the (white) strands under the (gray) strands until at least 6 full tucks, with all 4 strand pairs, have been completed (Fig. H).

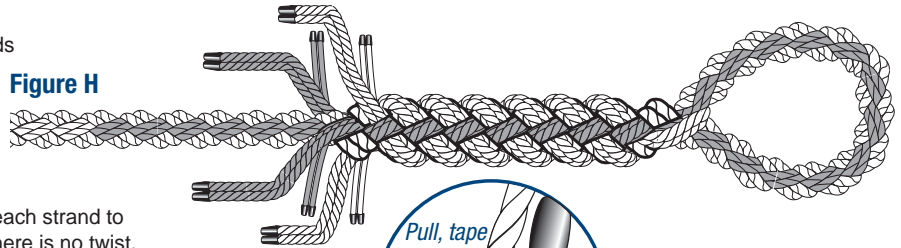

8B After each round of tucks, pull each strand to make sure they are snug and there is no twist.

8C Having completed 6 full tucks for each pair of strands you will need to reduce the strand volume by 1/3 before continuing the next set of tucks. To do this, cut 1 of the 3 strands out of each pair as shown (see detail at right.)

8D Continue tucking the remaining strands, with the (gray) strands under the (white) strands, and vice versa, for 3 more full tucks. The splice should look like Fig. I.

8E The tapering process continues by reducing the volume of the remaining strands by 1/2 (removing 1 of the 2 remaining strands.) Continue tucking the remaining strands for 3 more full tucks. Tape and cut off the remaining strands. The finished splice should look like Fig. J.

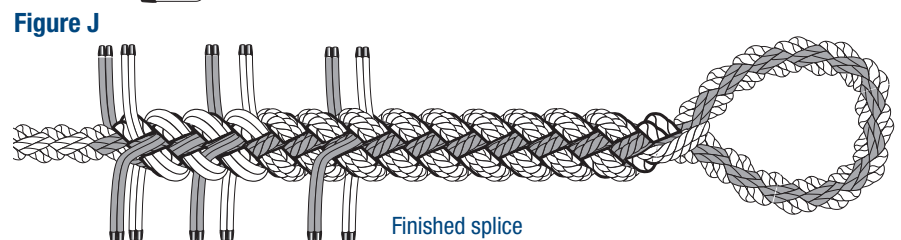
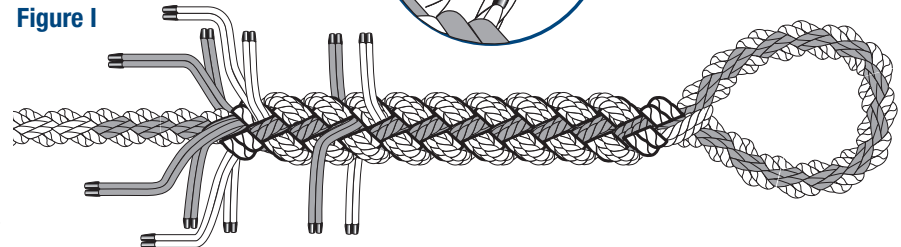

Note: The 8 ends can be heat fused so they don't fray, but be careful not to damage any of the strands.



12-Strand Class I End-For-End Splice

Class I 12-strand ropes are made from any or all of the following fibers: olefin, polyester, or nylon.

This end-for-end splice may be performed on new or used rope. This is an all-purpose splice technique designed for people who generally splice used rope as frequently as new rope. By following the procedure below, the splice can retain from 90% to 100% of average new rope strength and in used rope up to the same proportion of residual used rope strength.

Note: Some small sizes of 12-strand products have been converted to an 8-strand single braid.

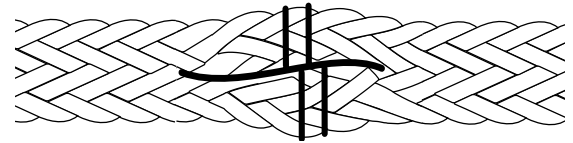

Finished splice

STEP 1 MEASURING AND MARKING

Tape ends of line to be spliced. Lay 2 ropes to be spliced side-by-side and measure 1 tubular fid length from taped end of each line and mark. This is Mark 1.

From Mark 1 measure 1 tubular fid lengths and make Mark 2 on both lines.

From Mark 2 measure 3 tubular fid lengths and make Mark 3 on both lines.

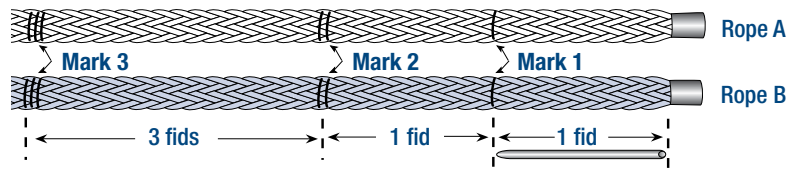

STEP 2 TAPERING TAIL

From Mark 1, in the direction of the taped end of the line, mark every 2nd right and then every 2nd left strand* for 3 strands.**

Pull every marked strand out of line and cut off (tape at end can cause resistance and may have to be removed in order to pull out cut strands.)

Tapered end will now have only 6 strands remaining (or 4 strands for an 8-strand braid.)

Tape tapered tail tightly to keep from unbraiding.

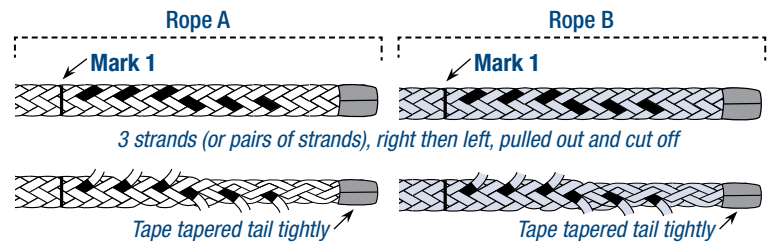

*Some rope diameters may have pairs of strands in right and left direction. In this case, treat the pairs of strands as a single strand, marking and cutting both in each direction as described above.

**For an 8-strand construction, mark every 3rd left and right strand for 2 strands.

STEP 3 REPOSITIONING ROPES

Reposition ropes for splicing according to diagram below.

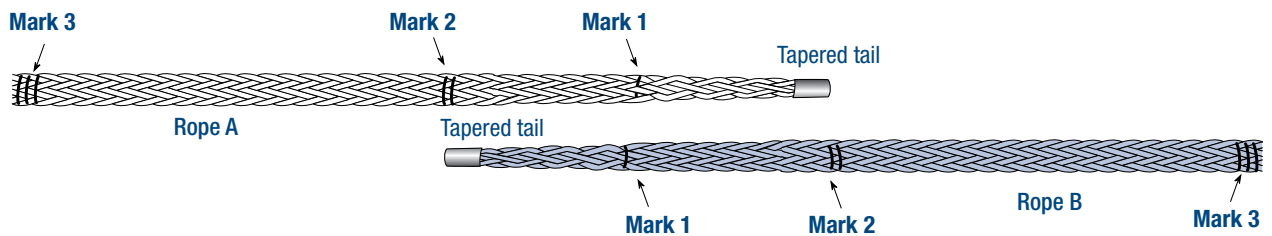

STEP 4 BURYING ROPE A INTO ROPE B

Attach fid to tapered end of Rope A and insert fid into Rope B at Mark 2. Bring out past Mark 3, then remove fid.

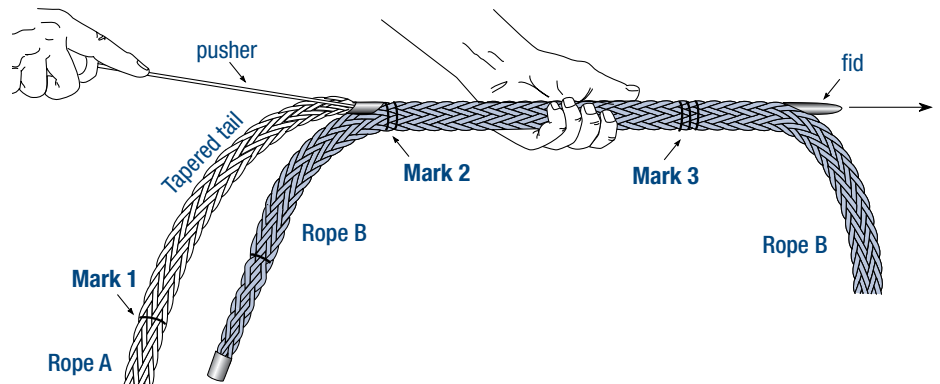

4A Tie off the tail of Rope A to a stationary object, then use both hands and weight of your body to smooth Rope B toward Rope A to bury Rope A up to its own Mark 2. Leave tail sticking out.



12-Strand Class I End-For-End Splice

STEP 5 FINISH BURYING

Attach tapered tail of Rope B to fid. Insert the fid into Rope A at Mark 2, approximately the diameter of the line away from insertion point of Rope A into Rope B. Bring fid and tail out at Mark 3 of Rope A. Following same procedures as Step 4A bury Rope B up to its own Mark 2. Leave tail sticking out.

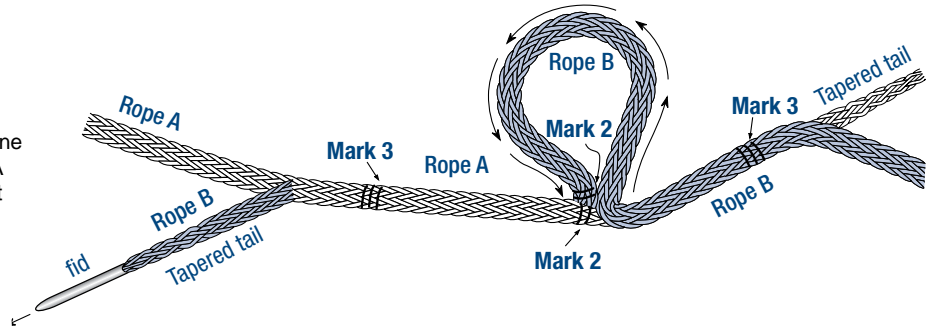

STEP 6 PERFORMING SECOND TAPER

Mark 3 consecutive strands as shown. Pull out all 3 and cut off.

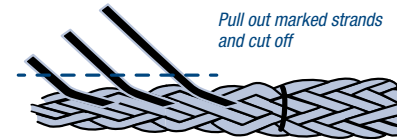
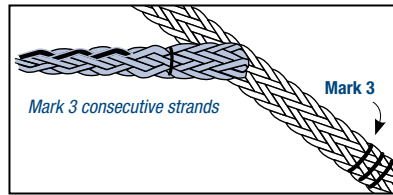

STEP 7 SMOOTHING OUT SPLICE

Pull both tails to tighten the crossover.

Now, using both hands and the weight of your body, smooth the cover slack from the crossover towards Mark 3 in both directions. The tails will disappear into the rope, and a smooth, gradual taper should result. Lock stitching should be done on both sides of the crossover of the buried tails to prevent the splice from pulling out.

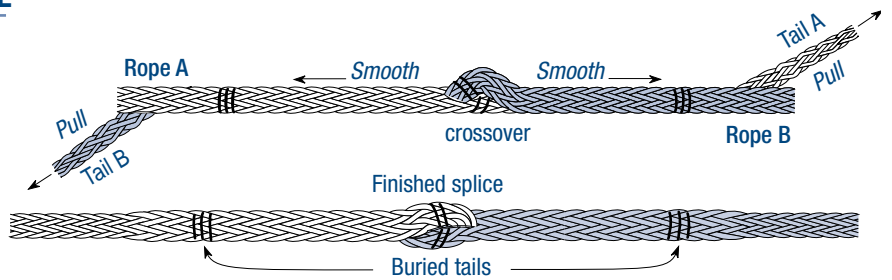

STEP 8 LOCK STITCHING PROCEDURE

From Mark 2 at crossover, count 12 picks in either direction and insert stitching twine.

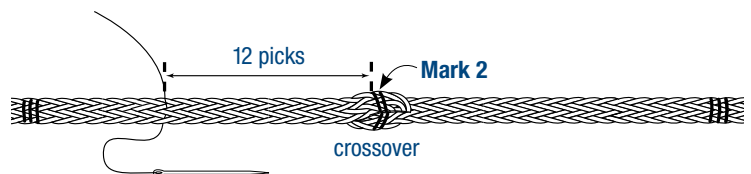

STEP 9

Working towards the crossover, stitch twine back and forth through splice until a minimum of 3 complete stitches have been made on each side of crossover.

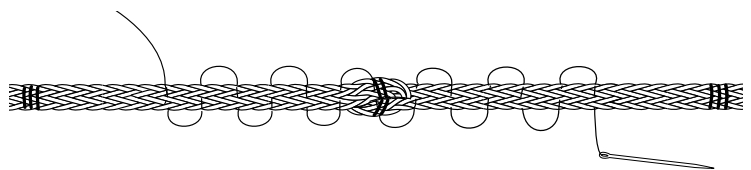

9A Tie an overhand knot in each end of the twine, as close to its exit point as possible.

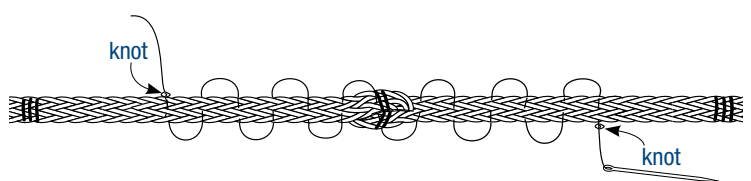

9B Insert tail of stitching twine at exact location where twine emerges. Using needle or small fid, pull (or push) through rope at a slight angle. Pull hard on the end of the twine so that the knot disappears inside the rope. Trim off the remaining twine close to the rope. Repeat on other end of the twine.

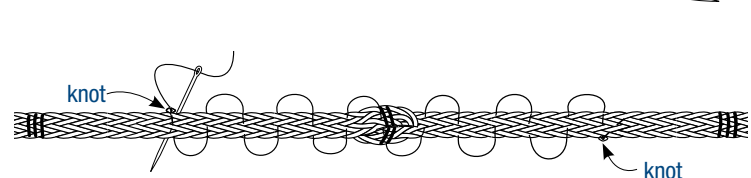



12-Strand Eye-and-Eye Tail Splice

NOTE: These instructions are intended for use with Samson's Tenex, Tenex-TEC (2 end per carrier Tenex), IceTail, or Tech-12 only.

The desired tail length will dictate the starting length of cordage required. For a 33" finished eye-and-eye tail, an 80" length of 3/8" rope is required.

STEP 1 MARKING TAIL LENGTH

Mark the center point of the rope. This is Mark A. Bring both ends of the rope towards the center point as shown and overlap the tails 1-1/2".

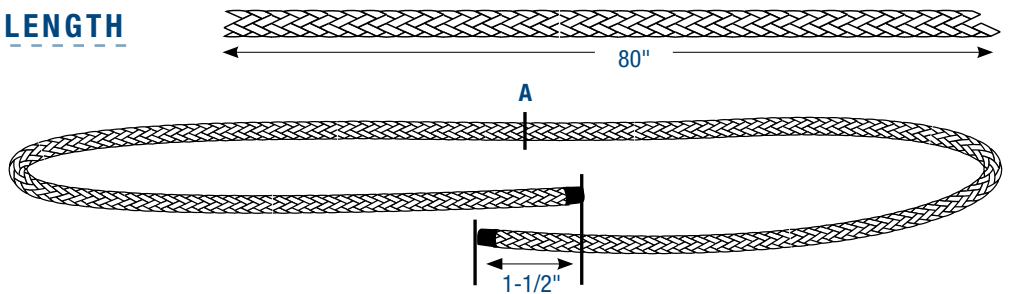

STEP 2 MARKING EYE SIZE

Mark the size of the eye on each tail. From the inside of the eye, mark both legs of the eye at 1-1/4". These are Marks B and C, as shown.

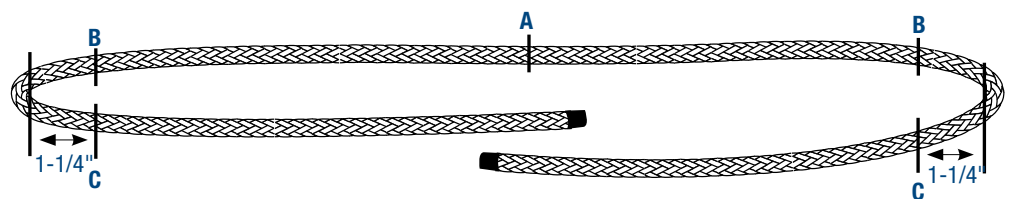

STEP 3 MARKING AND PULLING TAPERS

Mark the tapers. From Mark C towards the ends, count 12 strand pairs and begin taper marks on the 13th pair. Mark both a left hand and a right hand strand pair at each point for removal. Mark the 13th, 15th, and 17th. You should have a total of 6 strand pairs marked for removal at each end. Pull the marked strands from the rope, but do not cut. Replace the tape on both ends of the rope.

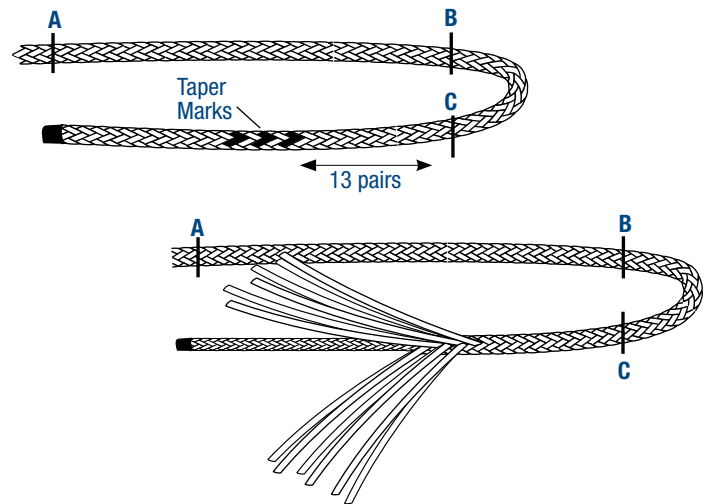

STEP 4 MARKING EXIT POINTS

From the midpoint marked in Step 1, measure four inches on each side of the center mark and make a mark. These will be the exit Points X.

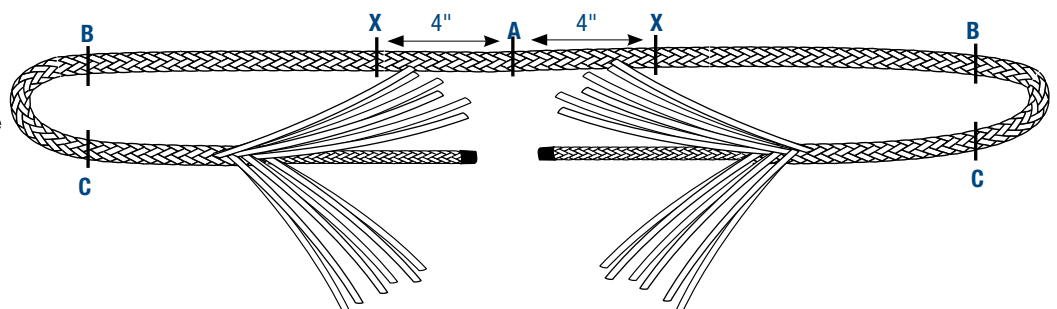



12-Strand Eye-and-Eye Tail Splice

STEP 5 FORMING AND CLOSING BRUMMEL

5A Form the locked Brummel on both ends. Pass the shorter taped end through the center of the rope at Mark B. Do not bury Mark C, leave on the entry side of standing rope.

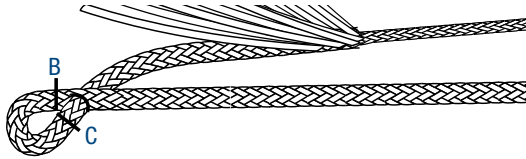

5B Pass the opposite end through the center of the tail, approximately 2 picks from where it exits the standing part of the rope. Close up the Brummel, bringing Marks B and C together at the vertex of the eye.

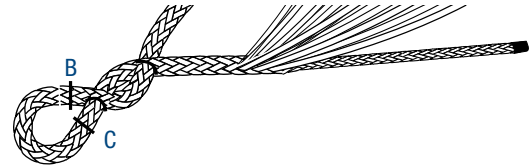

STEP 6 BURYING TAILS

Measure 2 picks from the point where the standing part passes through the tail. This is Mark D.

With a fid attached to the taped end of the tail, bury the tail from Mark D past the Midpoint A to Mark X. Just before the pulled taper strands are buried into the standing part of the rope, cut them off. Pull the tail out at Mark X as far as possible, and repeat Steps 5, 6, and 7 for the opposite end.

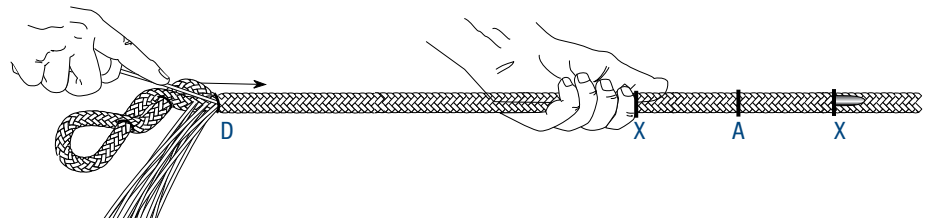
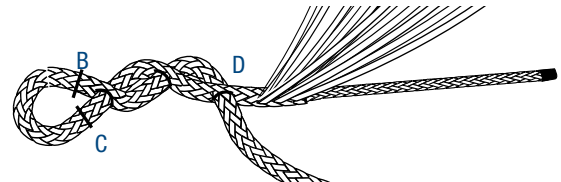

STEP 7 MARKING AND CUTTING ENDS

Smooth all slack from the rope, working from the Brummels to the center mark. Mark where the tapered ends exit the rope at both Marks X. Pull both tapered ends out from Mark X, measure 3-1/2" from previous mark where the tapers exited at Mark X (this is the section of both tapered ends that overlap in the center section), and cut off at an angle.

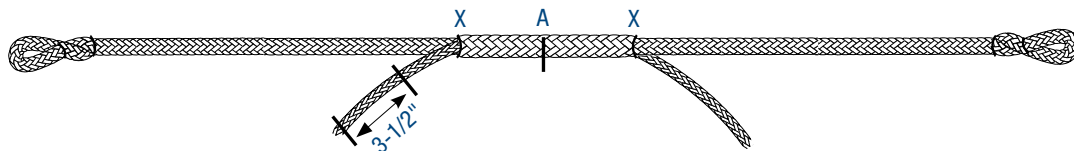

STEP 8 FINISHING SPLICE

Milk all slack from the Eye-and-Eye Tail. The goal is to keep the diameter and fullness of the rope consistent tied into a climbing hitch. When all slack has been removed and the diameter is consistent, lock stitch the eyes at both ends.

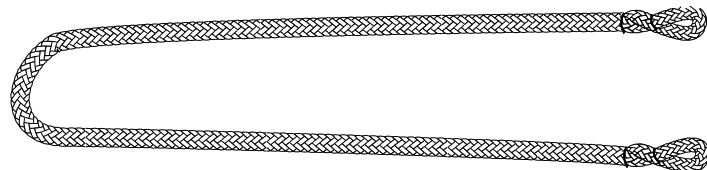



12-Strand Eye-and-Eye Tail Splice

STEP 1

Pass stitching twine through spliced area near throat of eye as shown.

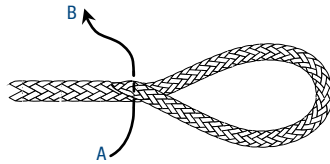

STEP 2

Reinsert twine through the rope. The twine should cover 2 strands from the exit point. Pull the twine snug, but not tight.

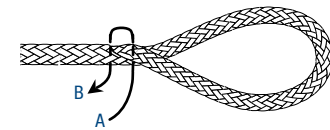

STEP 3

Continue to reinsert as shown until you have at least 3 complete stitches on each side of the rope. Each stitch should cross over 2 strands in the rope.

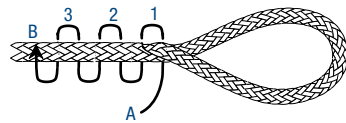

STEP 4

After completing Step 3, rotate spliced part of rope 90° and reinsert end A into spliced area in the same fashion as in Steps 1, 2 and 3. The splice will now be stitched on 2 planes perpendicular to each other. Make sure you do not pull the stitching too tight.

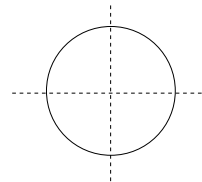

STEP 5

After stitching at least 3 complete stitches as in Step 3, extract both ends of the twine together through the same opening in the braid. Tie them together with a square knot and reinsert back into braid. For double braids, re-insert the knot between the cover and core.

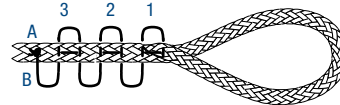

12-Strand Class I Eye Splice

Class I 12-strand ropes are made from any or all of the following fibers: olefin, polyester, or nylon.

The eye splice is used to place a permanent loop in the end of a rope, generally for attachment purposes to a fixed point. An eye is also used to form the rope around a thimble, which is used to protect the rope, especially when it is to be attached to a shackle, chain, or wire rope.

This eye splice may be performed on new or used rope. This is an all-purpose splice technique designed for people who generally splice used rope as frequently as new rope. By following the procedure below, the splice can retain from 90% to 100% of average new rope strength and, in used rope, up to the same proportion of residual used rope strength.

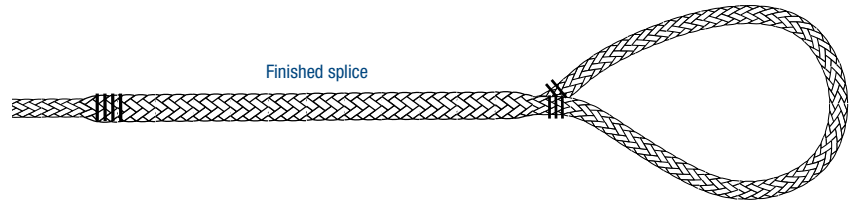

STEP 1 MEASURING

Tape end of line to be spliced and measure 1 tubular fid length from taped end of line and make Mark 1.

From Mark 1 measure 1 tubular fid length and make Mark 2. Now form size of eye desired and make Mark 3 adjacent to Mark 2.

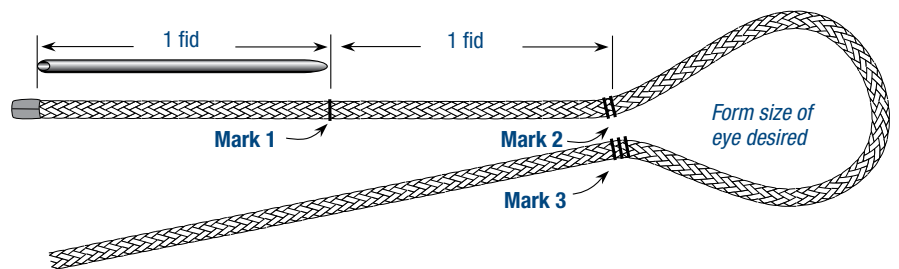

STEP 2 MAKING TAPER

From Mark 1, toward the taped end of the line, mark every second right and then every second left strand* for 3 strands.** Pull every marked strand out of line and cut off (tape at end can cause resistance and may have to be removed in order to pull out cut strands.) Tapered end will now have only 6 strands remaining (or 4 strands for an 8-strand braid.) Tape tapered tail tightly to keep from unbraiding.

**Some rope diameters may have pairs of strands in right and left direction. In this case, treat the pairs of strands as a single strand, marking and cutting both in each direction as described above.*

***Some very small diameter ropes may be 8-strand. For an 8-strand construction, mark every 3rd left and right strand for 2 strands.*

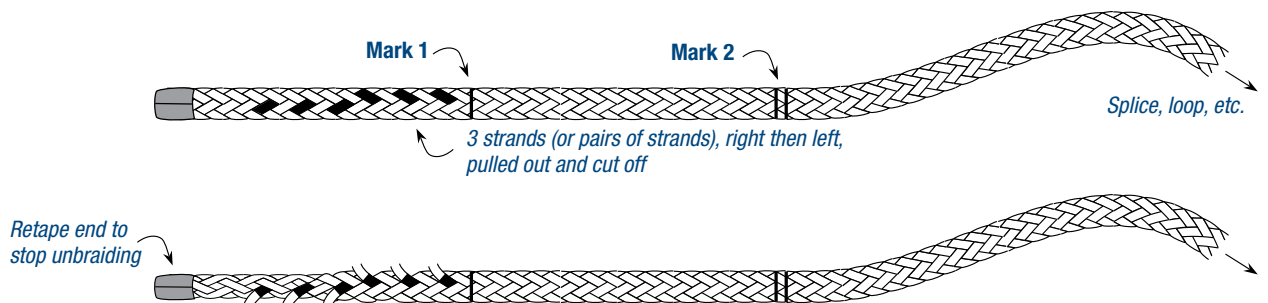

STEP 3 BURYING TAIL INTO STANDING PART OF LINE

Measure 2-1/2 tubular fid lengths (4 wire fid lengths), make Mark 4. Insert fid and tapered tail at Mark 3 and push out beyond Mark 4.

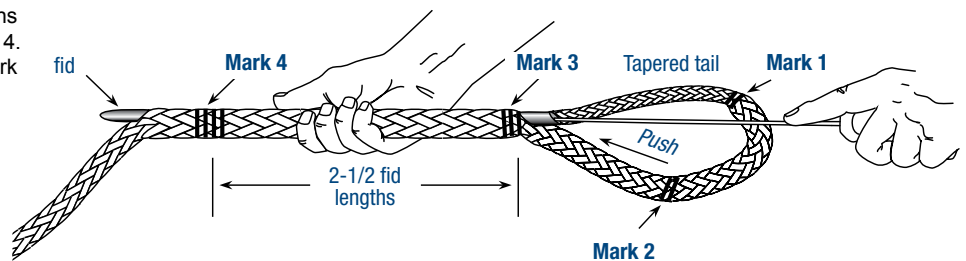



12-Strand Class I Eye Splice

STEP 4 FINISHING BURYING

Remove fid. Pull hard on tapered tail with one hand. With other hand, smooth bunched line towards eye splice until Marks 2 and 3 converge.

4A Remove the fid and any tape at the end of the tail. From the end of the tail, Mark 3 consecutive strands, as shown. Pull them out of the braid and cut off close to the body of the rope.

4B Now, using both hands and the weight of your body, smooth the cover slack from Mark 3 towards Mark 4. The tail will disappear into the rope, and a smooth, gradual taper should result.

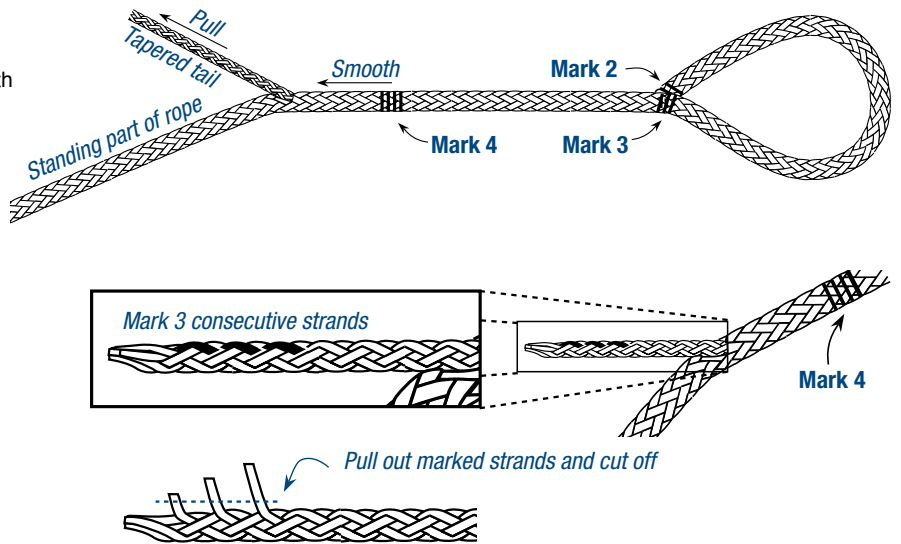

STEP 5 FINISHING EYE SPLICE

When finished, Mark 2 and Mark 3 should be at the same point in the vertex of the eye—which yields desired eye size. To finish eye splice, the splice must be lock stitched (procedure follows).

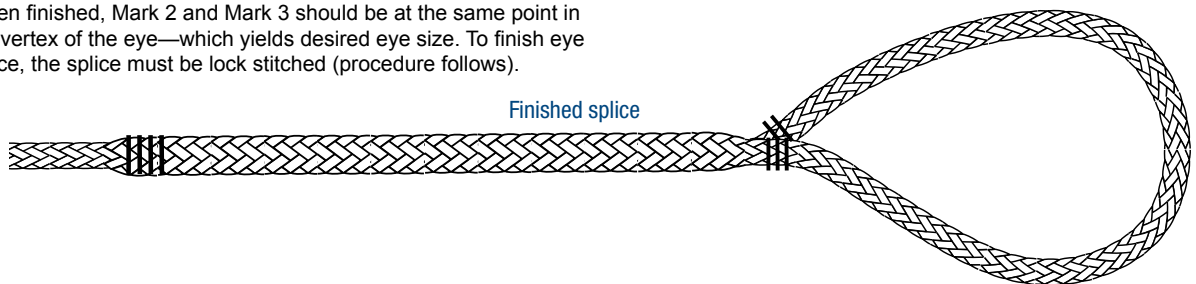

Lock Stitching Procedure

STEP 1
Pass stitching twine through spliced area near throat of eye as shown.

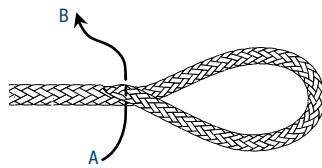

STEP 2
Reinsert twine through the rope. The twine should cover 2 strands from the exit point. Pull the twine snug, but not tight.

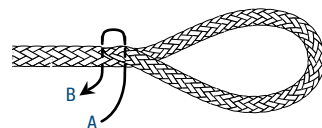

STEP 3
Continue to reinsert as shown until you have at least 3 complete stitches on each side of the rope. Each stitch should cross over 2 strands in the rope.

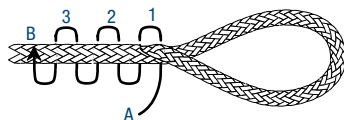

STEP 4
After completing Step 3, rotate spliced part of rope 90° and reinsert end A into spliced area in the same fashion as in Steps 1, 2 and 3. The splice will now be stitched on 2 planes perpendicular to each other. Make sure you do not pull the stitching too tight.

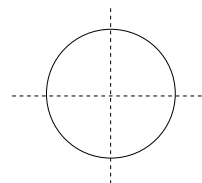

STEP 5
After stitching at least 3 complete stitches as in Step 3, extract both ends of the twine together through the same opening in the braid. Tie them together with a square knot and reinsert back into braid. For double braids, re-insert the knot between the cover and core.

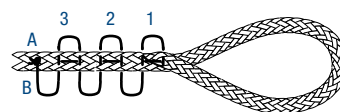

SAMSON SPLICING INSTRUCTIONS



samson
THE STRONGEST NAME IN ROPE

12-Strand Class I Whoopie Sling for Tenex™ / Tenex-TEC™

These instructions are intended for use with Samson's *Tenex* and *Tenex-TEC* (two-end per carrier *Tenex*) only. Published Whoopie Sling strengths are for Samson's *Tenex-TEC* when spliced in accordance with these instructions.

Note: For longer sling lengths, determine length needed beyond the maximum length listed in the table to the right. Multiply the length needed by two and add resulting amount to cut length. For example: If you need a maximum length of 8 ft. on a 3/4 inch sling, this is 2 ft. longer than the listed max length. Multiply 2 ft. x 2 = 4 ft. Add this to the original cut length (4 ft. + 15 ft. = 19 ft.). Your cut length will need to be 28 ft. to make a sling that adjusts to 12 ft.

STEP 1 SPLICING FIXED EYE

Using these measurements do the **Locked Brummel Splice**. Directions are as follows:

CUT LENGTHS FOR SLINGS:

Rope Size	Cut Length	Sling Adjusts From/To
1/2"	10'	30" to 48"
5/8"	12'	36" to 60"
3/4"	15'	42" to 72"

All slings use the same measurements with proper size fid.

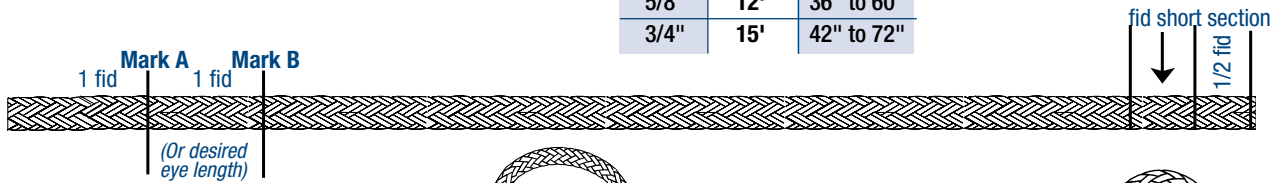

1A Leave tail at full volume. Just cut end at an angle, then tape.

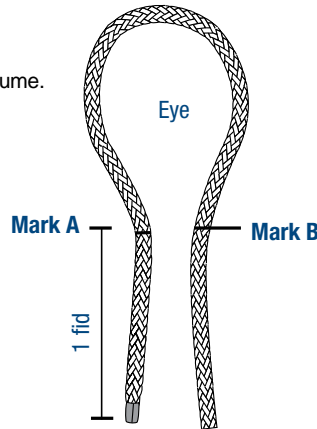

1B Pass taped end through center of rope at Mark B. Do not bury Mark A, leave on entry side of standing rope.

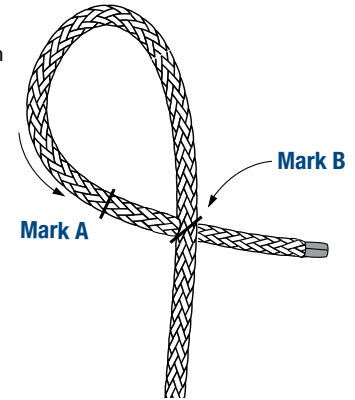

1C Pass the opposite end through the center of the tail approximately 2 picks from where it exits the standing rope.

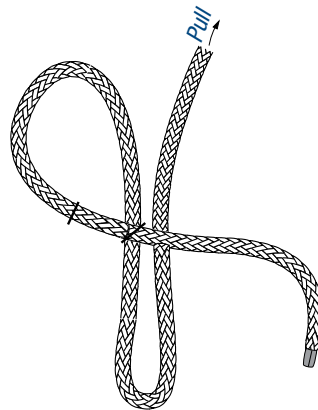

1D Close up Brummel.

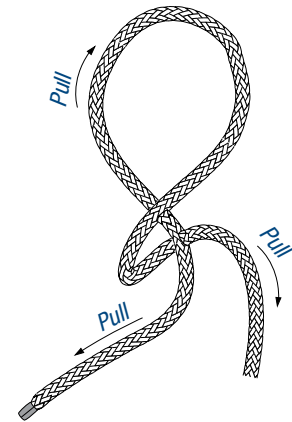

1E To bury the tail into the standing end, make a mark approximately 2 picks from where the standing part passes through the tail (Mark C). This will be the tail entry point. From Mark C, measure down the standing part 1 fid length and make Mark D. Insert fid and tapered tail at Mark C and bring out at Mark D. Remove fid and smooth the standing part out, which will bury the entire tail.

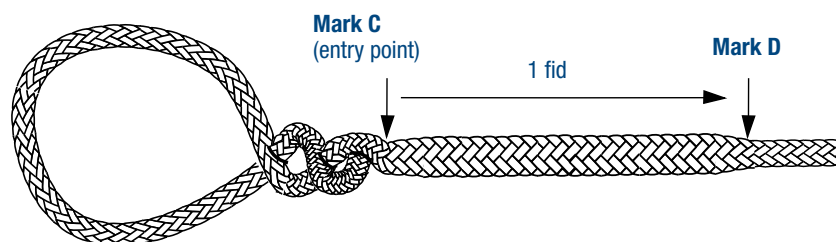



12-Strand Class I Whoopie Sling for Tenex™ / Tenex-TEC™

STEP 2 CREATING ADJUSTABLE LOOP

2A From Mark D measure 1-1/4 fids and make Mark E.

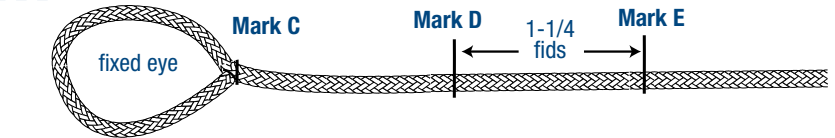

2B Attach end of rope to a fid and pass the fid and tail in at Mark E and out of Mark D. Pull the tail end through the buried portion and leave the tail exposed.

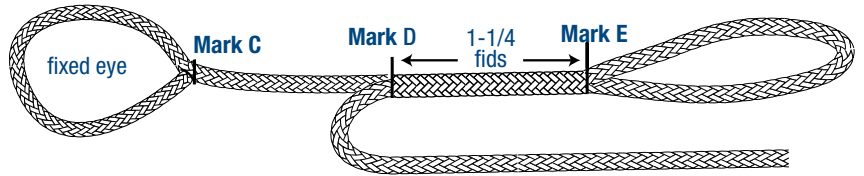

STEP 3 BACK SPLICING THE END

From the unspliced end of the rope, measure 1/2 fid plus a fid short section. Use these marks to do a Back Splice as follows:

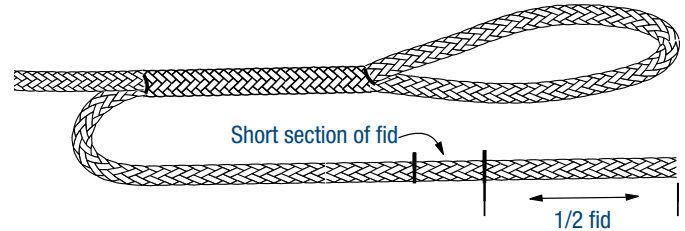

3A Insert the end of the rope in at the 1/2 fid mark and out at the short section mark.

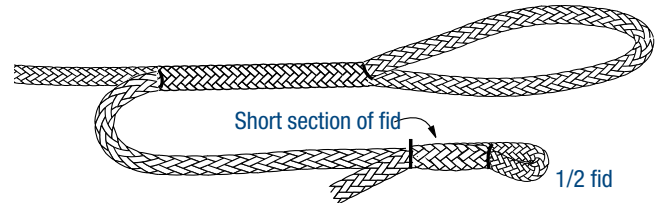

3B Pull firmly on the tail until the "eye" completely closes.

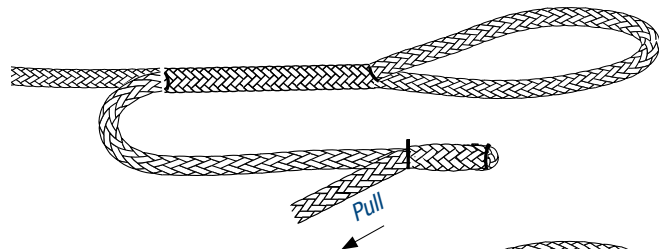

3C Grasp the "butt" of the splice and milk back towards exit point.

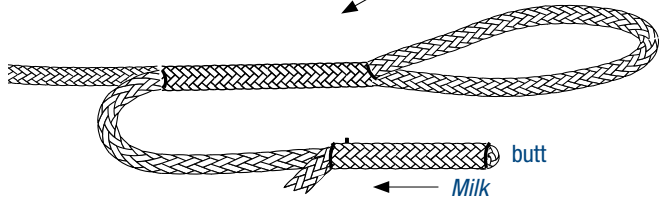

3D Mark the tail at the exit point. Pull the tail out slightly and cut off at an angle.

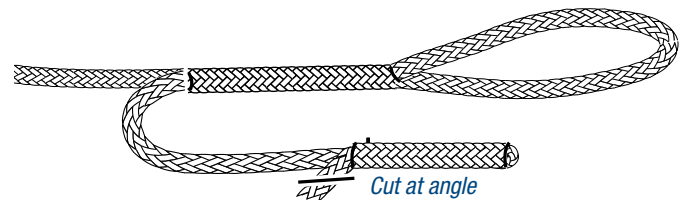

3E Re-milk to bury tail.



Completed Whoopie Sling

SAMSON SPLICING INSTRUCTIONS



samson
THE STRONGEST NAME IN ROPE

12-Strand Class II End-for-End Splice Modified for Dirty, Used Rope

Class II ropes are made in whole or part from high modulus fibers: Dyneema®, Vectran®, Technora®, and Zylon®.

This splicing procedure is specifically for used, dirty ropes that require repair or re-splicing. By following the procedure below, the spliced rope can retain from 90% to 100% of the residual strength of the used rope strength.

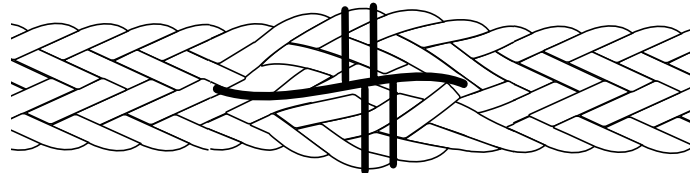

Finished splice

STEP 1 SOAKING USED ROPE

Fill a large bucket with clean, warm water. Place the area of the rope that will be spliced in the bucket to soak.



STEP 2 CLEANING USED ROPE

Starting at one end of the rope, grab the rope and “birdcage” the rope while underwater. This means that you will slack and milk the rope while in the bucket to clean out the interior section of the rope.



2A As the water may be dirty after the first round of cleaning, you may need to dump the water out and start with a fresh bucket of water. Continue to refresh water and wash until the rope appears clean.



STEP 3 SQUEEGEEING WATER FROM ROPE

Using your hand or another small piece of rope, squeegee out as much water from the wet rope as you can.



12-Strand Class II End-for-End Splice Modified for Dirty, Used Rope

STEP 4 MEASURING AND MARKING

Tape ends of line to be spliced. Lay the 2 ropes to be spliced side by side and measure 1 tubular fid length (2 wire fid lengths) from taped end of each line and make a mark. This is Mark 1.

From Mark 1, measure 2 tubular fid lengths (4 wire fid lengths from end of rope) and make Mark 2 on both lines.

From Mark 2, measure 4 tubular fid lengths (8 wire fid lengths from end of rope) and make Mark 3 on both lines.

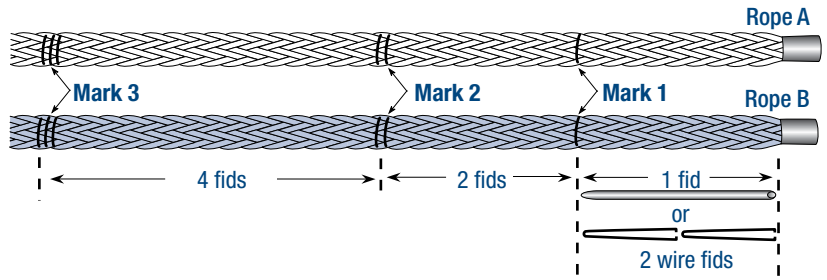

STEP 5 TAPERING TAIL

From Mark 1, in the direction of the taped end of the line, mark every second right and left strand for 3 strands.

Pull every marked strand out of line and cut off (tape at end can cause resistance and may have to be removed in order to pull out cut strands.) Tapered end will now have only 6 strands remaining.

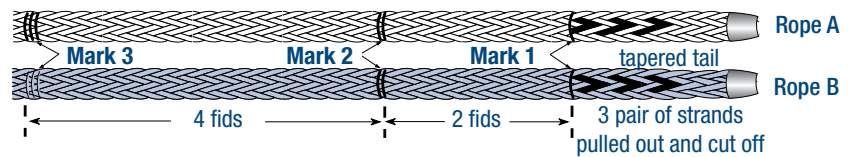

5A TAPERING TAIL FROM THE END:

From the end of the rope, mark 3 consecutive strands as shown. Pull out all 3 and cut off.

Repeat for other rope's tail.



STEP 6 TAPING BOTH TAPERED AREAS

Tape both areas of taper where you have cut the strands so they do not bunch up in the splice. Use a fid that allows the rope tail to fit into it. The smaller diameter allows the fid to pass through the rope easier.



STEP 7 REPOSITIONING ROPES

Reposition ropes for splicing according to diagram below.

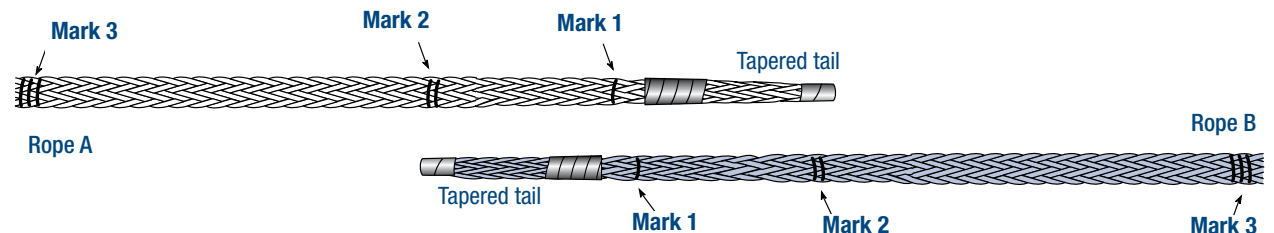



12-Strand Class II End-for-End Splice Modified for Dirty, Used Rope

STEP 8 BURYING ROPE A INTO ROPE B

Attach tail of Rope A to fid. Insert fid at Mark 2 of Rope B, bring out past Mark 3, then remove fid. When feeding the fid through with the tail attached, do not hold on to the fid and try to milk the slack back. Doing this will cause the tapered end to disconnect from the fid. Hold on to the section of the tapered end right above the fid to avoid this.

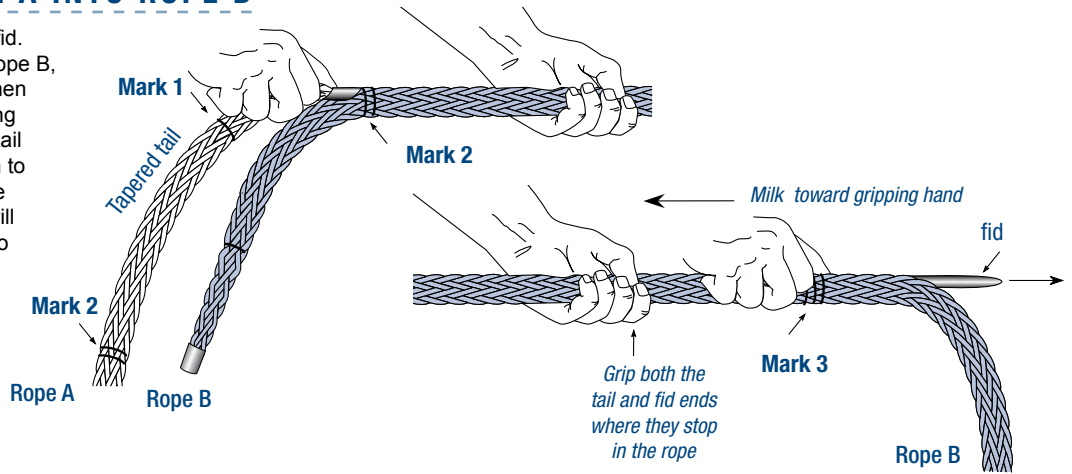

8A Tie off the tail of Rope A to a stationary object, then use both hands and weight of your body to smooth Rope B toward Rope A to bury Rope A up to its own Mark 2. Leave tail sticking out.



STEP 9 FINISH BURYING

Attach tapered tail of Rope B to fid. Insert the fid into Rope A at Mark 2, approximately the diameter of the line away from insertion point of Rope A into Rope B. Bring fid and tail out at Mark 3 of Rope A. Following same procedures as Step 8A bury Rope B up to its own Mark 2. Leave tail sticking out.

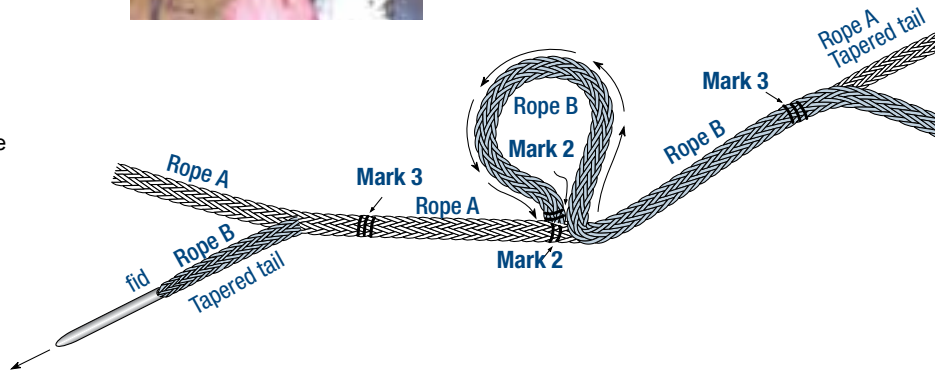

STEP 10 SMOOTHING OUT SPLICE

Pull both tails to tighten crossover. Next, smooth braid in both directions away from the crossover, stroking rope firmly. Tails should bury inside cover.

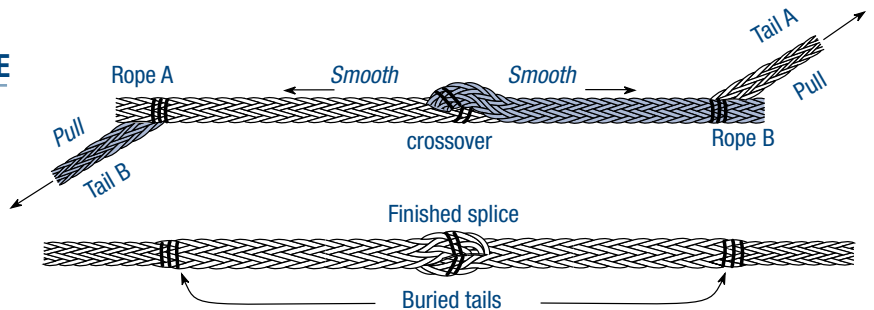



12-Strand Class II End-for-End Splice Modified for Dirty, Used Rope

STEP 11 LOCK STITCHING PROCEDURE

From Mark 2 at crossover, count 8 picks in either direction and insert stitching twine.

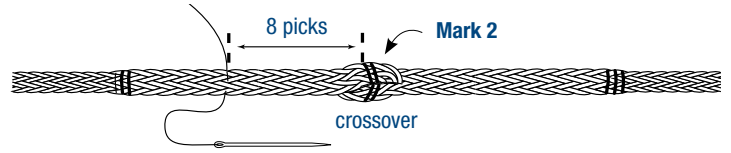

STEP 12 Working towards the crossover, stitch twine back and forth through splice until a minimum of 3 complete stitches have been made on each side of crossover.

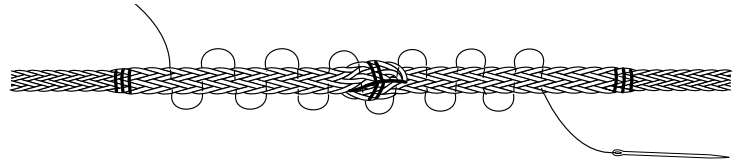

12A Tie an overhand knot in each end of the twine, as close to its exit point as possible.

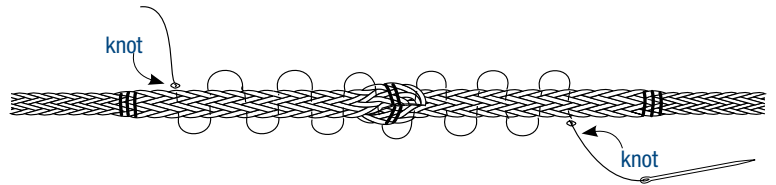

12B Insert tail of stitching twine at exact location where twine emerges. Using needle or small fid, pull (or push) through rope at a slight angle. Pull hard on the end of the twine so that the knot disappears inside the rope. Trim off the remaining twine close to the rope. Repeat on other end of the twine.

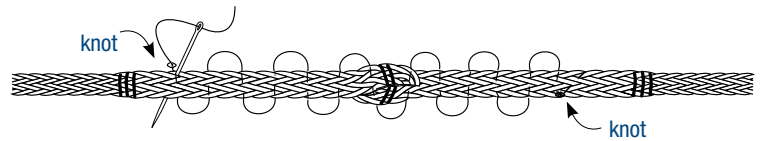



12-Strand Class II End-For-End Splice

Class II ropes are made in whole or part from high modulus fibers: Dyneema®, Vectran®, Technora®, and Zylon®.

This end-for-end splice may be performed on new or used rope. This is an all-purpose splice technique designed for people who generally splice used rope as frequently as new rope. By following the procedure below, the splice can retain from 90% to 100% of average new rope strength and in used rope up to the same proportion of residual used rope strength.

Note: Some small sizes of 12-strand products have been converted to an 8-strand single braid.

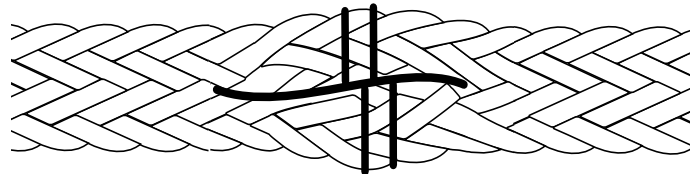

Finished splice

STEP 1 MEASURING AND MARKING

Tape ends of line to be spliced. Lay 2 ropes to be spliced side by side and measure 1 tubular fid length, from taped end of each line and make a mark. This is Mark 1.

From Mark 1, measure 2 tubular fid lengths and make Mark 2 on both lines.

From Mark 2, measure 4 tubular fid lengths and make Mark 3 on both lines.

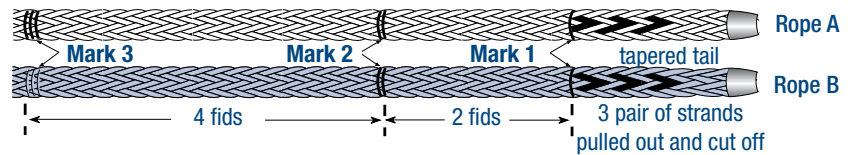
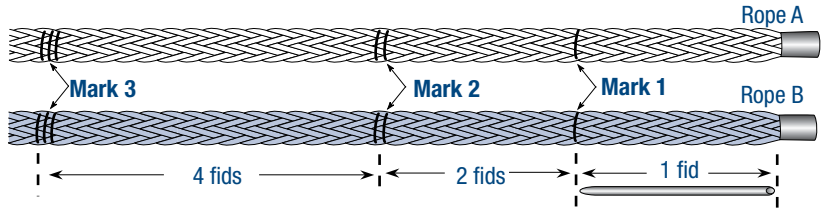

STEP 2 TAPERING TAIL

From Mark 1, in the direction of the taped end of the line, mark every second right and left strand* for 3 strands.**

Pull every marked strand out of line and cut off (tape at end can cause resistance and may have to be removed in order to pull out cut strands.)

Tapered end will now have only 6 strands remaining (or 4 strands if the rope is an 8-strand construction.) Re-tape tapered tail tightly to keep from unbraiding.

**Some rope diameters may have pairs of strands in right and left direction. In this case, treat the pairs of strands as a single strand, marking and cutting both in each direction as described below.*

***Some very small diameters may be 8-strand construction. For an 8-strand construction, mark every 3rd left and right strand for 2 strands.*

STEP 3 REPOSITIONING ROPES

Reposition ropes for splicing according to diagram below.

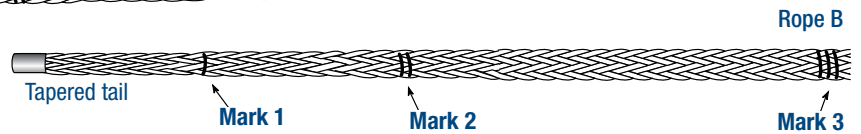

STEP 4 BURYING ROPE A INTO ROPE B

Attach fid to tapered end of Rope A and insert fid into Rope B at Mark 2. Bring out past Mark 3, then remove fid.

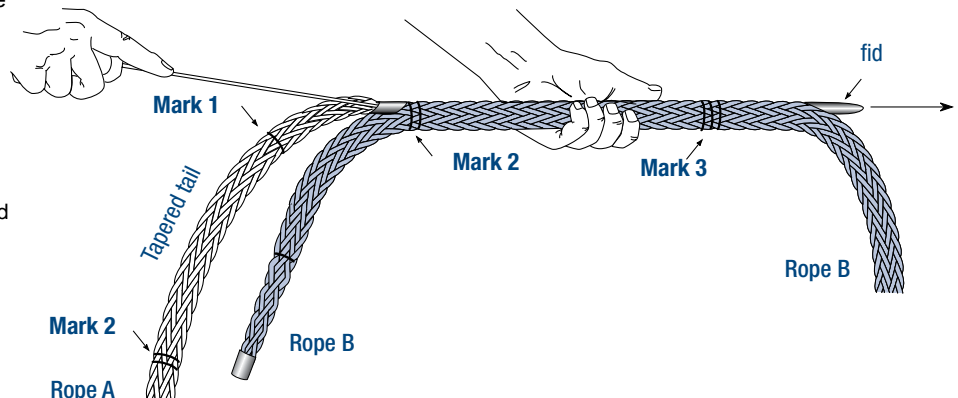

4A Tie off the tail of Rope A to a stationary object, then use both hands and weight of your body to smooth Rope B toward Rope A to bury Rope A up to its own Mark 2. Leave tail sticking out.



12-Strand Class II End-For-End Splice

STEP 5 FINISH BURYING

Attach tapered tail of Rope B to fid. Insert the fid into Rope A at Mark 2, approximately the diameter of the line away from insertion point of Rope A into Rope B. Bring fid and tail out at Mark 3 of Rope A. Following same procedures as Step 4A bury Rope B up to its own Mark 2. Leave tail sticking out.

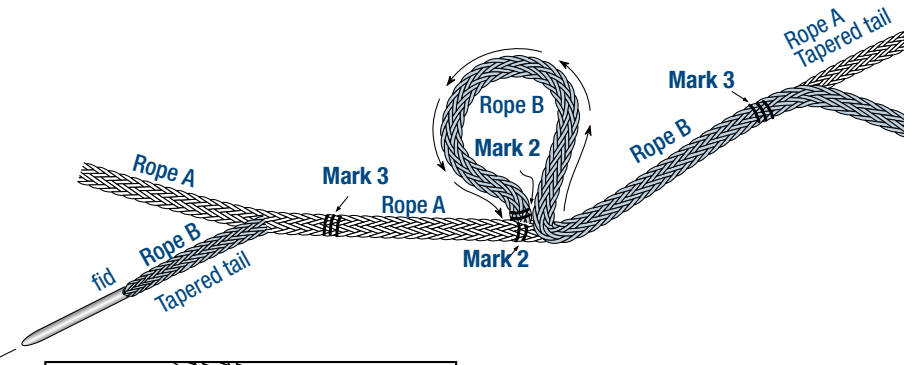

STEP 6 TAPERING SECOND TAIL

Mark 3 consecutive strands as shown. Pull out all 3 and cut off. Repeat for other rope's tail.

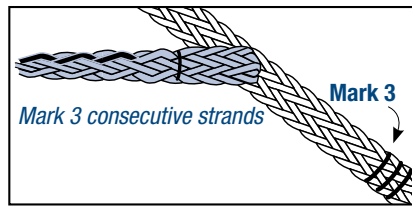

STEP 7 SMOOTHING OUT SPLICE

Pull both tails to tighten crossover. Next, smooth braid in both directions away from the crossover, stroking rope firmly. Tails should bury inside cover.

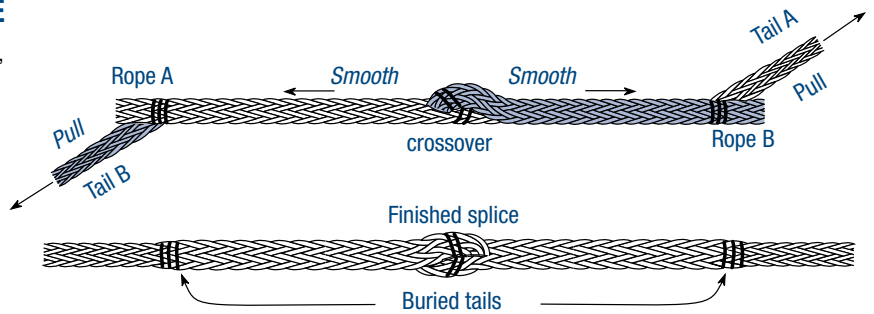

STEP 8 LOCK STITCHING PROCEDURE

From Mark 2 at crossover, count 12 picks in either direction and insert stitching twine.

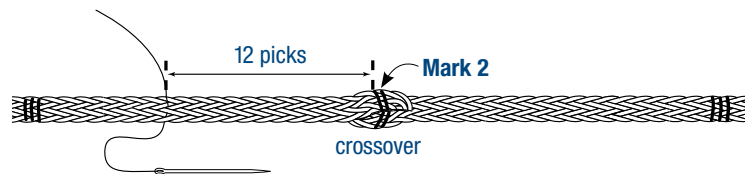

STEP 9

Working towards the crossover, stitch twine back and forth through splice until a minimum of 3 complete stitches have been made on each side of crossover.

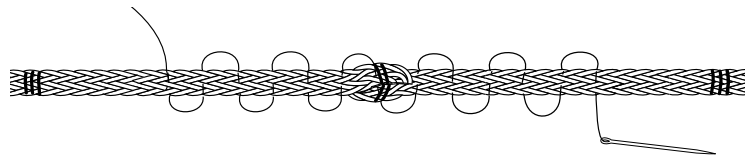

9A Tie an overhand knot in each end of the twine, as close to its exit point as possible.

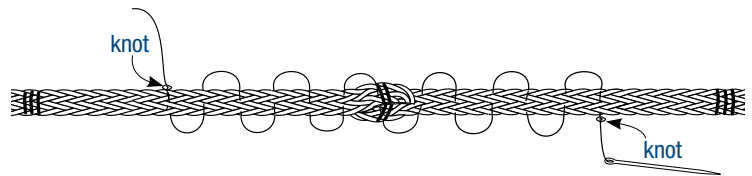

9B Insert tail of stitching twine at exact location where twine emerges. Using needle or small fid, pull (or push) through rope at a slight angle. Pull hard on the end of the twine so that the knot disappears inside the rope. Trim off the remaining twine close to the rope. Repeat on other end of the twine.

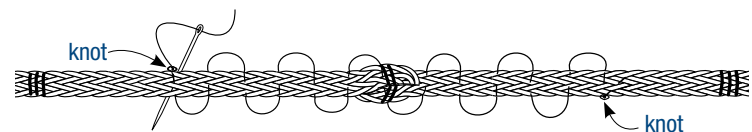

12-Strand Class II Eye Splice

Class II ropes are made in whole or part from any of the following high modulus fibers: Dyneema®, Vectran®, Technora®, and Zylon®.

The eye splice is used to place a permanent loop in the end of a rope, generally for attachment purposes to a fixed point. An eye is also used to form the rope around a thimble, which is used to protect the rope, especially when it is to be attached to a shackle, chain, or wire rope.

This eye splice may be performed on new or used rope. This is an all-purpose splice technique designed for people who generally splice used rope as frequently as new rope. By following the procedure below, the splice can retain from 90% to 100% of average new rope strength and in used rope up to the same proportion of residual used rope strength.

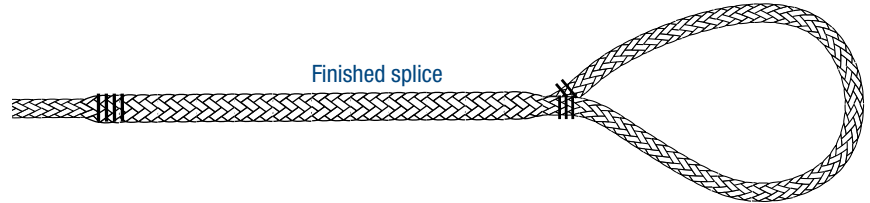

STEP 1 MEASURING

Tape end of line to be spliced and measure 1 tubular fid length from taped end of line and make Mark 1.

From Mark 1 measure 2 tubular fid lengths and make Mark 2. Now form size of eye desired and make Mark 3.

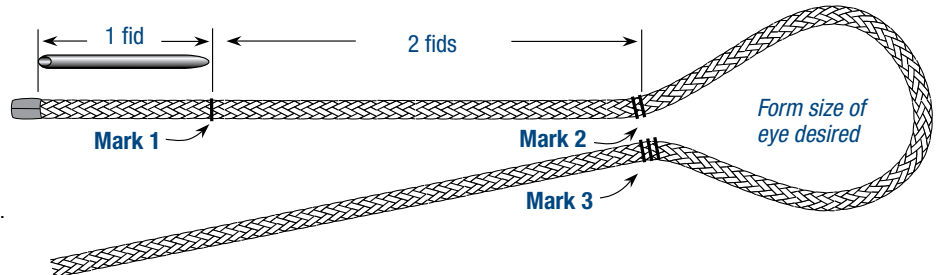

STEP 2 MAKING TAPER

From Mark 1, in the direction of the taped end of the line, mark every second right and left strand* for 3 strands.** Pull every marked strand out of line and cut (tape at end can cause resistance and may have to be removed in order to pull out cut strands.) Tapered end will now have only 6 strands remaining (or 4 strands for an 8-strand braid.) Tape tapered tail tightly to keep from unbraiding.

**Some rope diameters may have pairs of strands in right and left direction. In this case, treat the pairs of strands as a single strand, marking and cutting both in each direction as described above.*

***Some very small diameter ropes may be 8-strand. For an 8-strand construction, mark every 3rd left and right strand for 2 strands.*

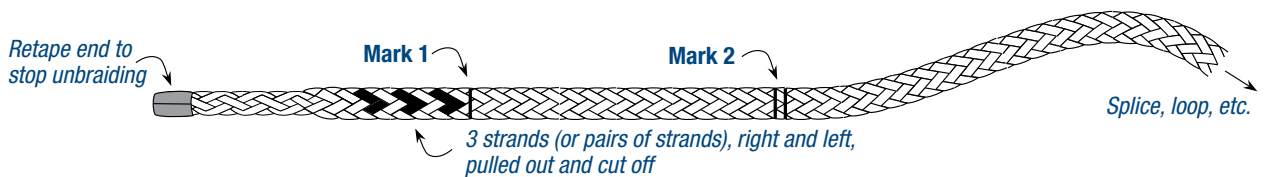

STEP 3 BURYING TAIL INTO STANDING PART OF LINE

Measure 4 tubular fid lengths from Mark 3, make Mark 4. Insert fid and tapered tail at Mark 3 and bring fid out beyond Mark 4. Pull fid and tapered tail out. Do not let the line twist.

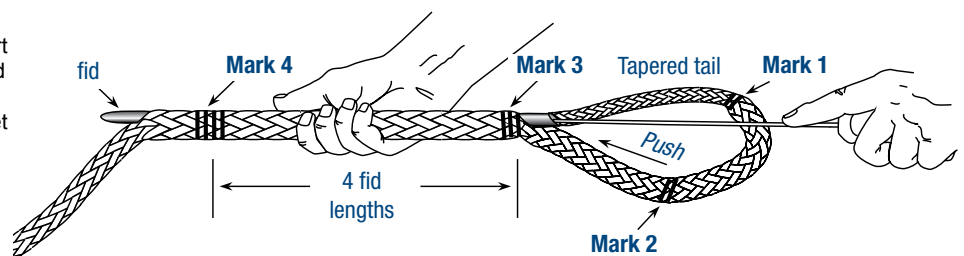



12-Strand Class II Eye Splice

STEP 4 FINISHING BURYING

Remove fid. Pull hard on tapered tail with one hand. With the other hand, smooth bunched line towards eye splice until Marks 2 and 3 converge.

4A Remove the fid and any tape at the end of the tail. From the end of the tail, mark 3 consecutive strands, as shown. Pull them out of the braid and cut off close to the body of the rope.

4B Now, using both hands and the weight of your body, smooth the cover slack from Mark 3 towards Mark 4. The tail will disappear into the rope, and a smooth, gradual taper should result.

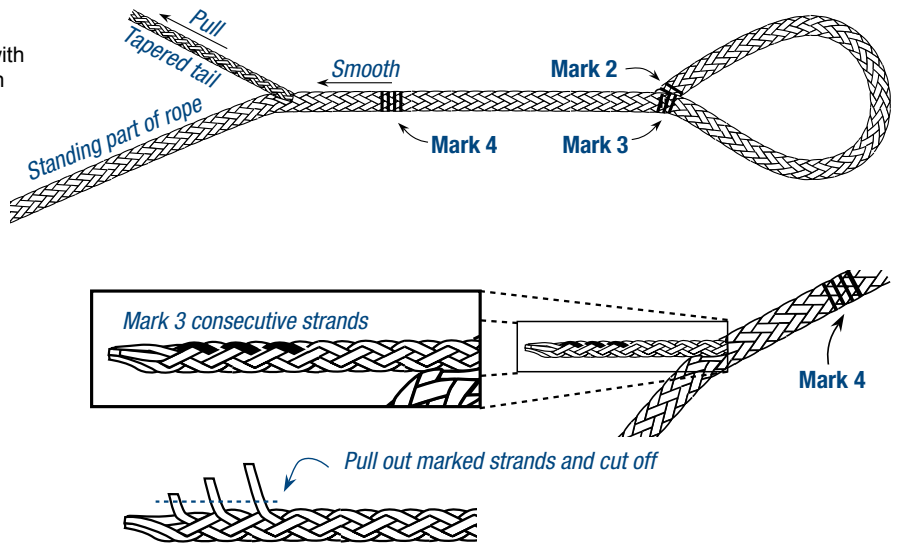

STEP 5 FINISHING EYE SPLICE

When finished, Mark 2 and Mark 3 should be at the same point at the vertex of the eye—which, yields desired eye size. To finish eye splice, the splice must be lock stitched (procedure follows).

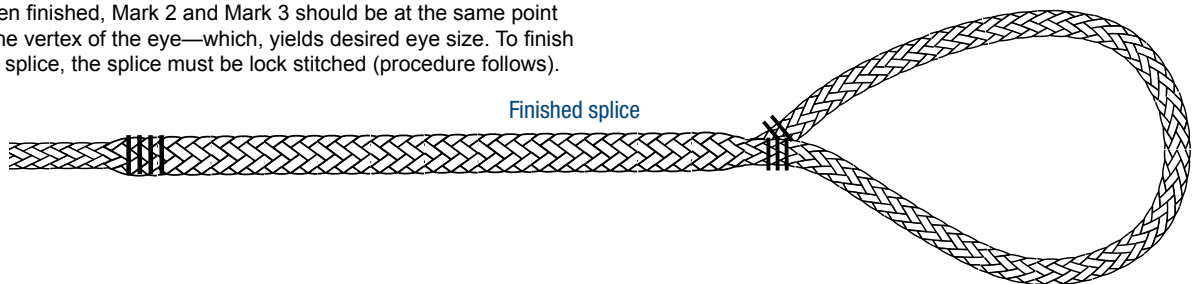

Lock Stitching Procedure

STEP 1
Pass stitching twine through spliced area near throat of eye as shown.

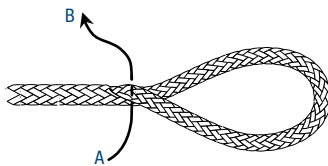

STEP 2
Reinsert twine through the rope. The twine should cover 2 strands from the exit point. Pull the twine snug, but not tight.

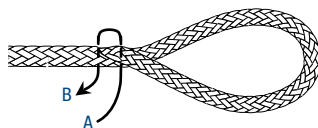

STEP 3
Continue to reinsert as shown until you have at least 3 complete stitches on each side of the rope. Each stitch should cross over 2 strands in the rope.

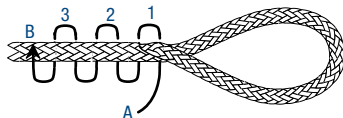

STEP 4
After completing Step 3, rotate spliced part of rope 90° and reinsert end A into spliced area in the same fashion as in Steps 1, 2 and 3. The splice will now be stitched on 2 planes perpendicular to each other. Make sure you do not pull the stitching too tight.

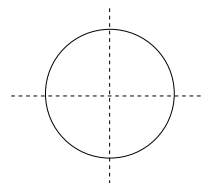

STEP 5
After stitching at least 3 complete stitches as in Step 3, extract both ends of the twine together through the same opening in the braid. Tie them together with a square knot and reinsert back into braid. For double braids, re-insert the knot between the cover and core.

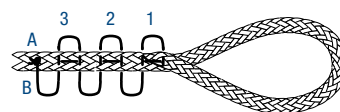



Hi-Tech Purseline Class II Eye Splice

The round plait construction requires a splicing technique different from other 12-strand braided ropes. The "tuck" procedure may be performed in the field on both new and used rope with a minimum of tools.

The eye splice is used to place a permanent loop in the end of a rope, generally for attachment purposes to a fixed point. An eye is also used to form the rope around a thimble, which is used to protect the rope, especially when it is to be attached to a shackle, chain, or wire rope.

STEP 1 MEASURING AND MARKING

From the end of the rope, measure 1 fid length. At this point put 1 loose wrap of tape around the rope. This is Mark 1.

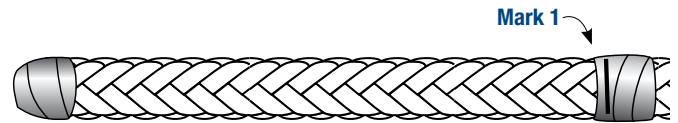

1A Form the desired eye size using the tape wrapped around the rope as a reference mark. Mark the body of the rope at the point where it matches up with Mark 1. This is Mark 2. Measure 1 fid length toward the standing end of the rope and mark the body, this is Mark 3.

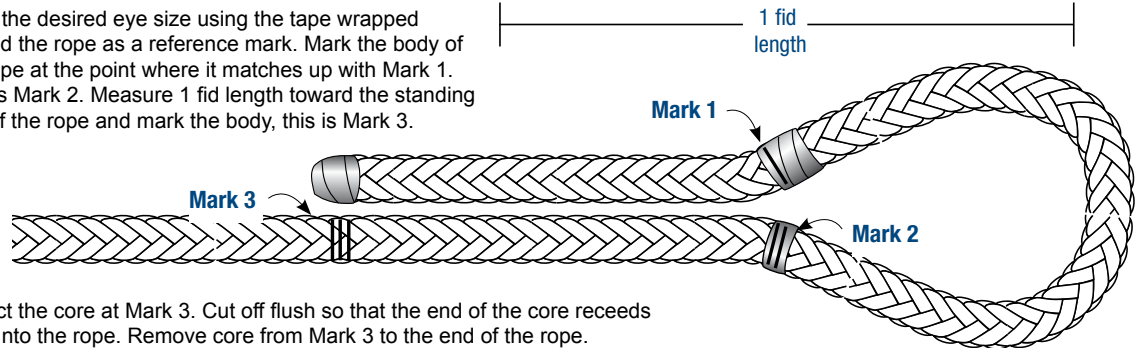

1B Extract the core at Mark 3. Cut off flush so that the end of the core recedes back into the rope. Remove core from Mark 3 to the end of the rope.

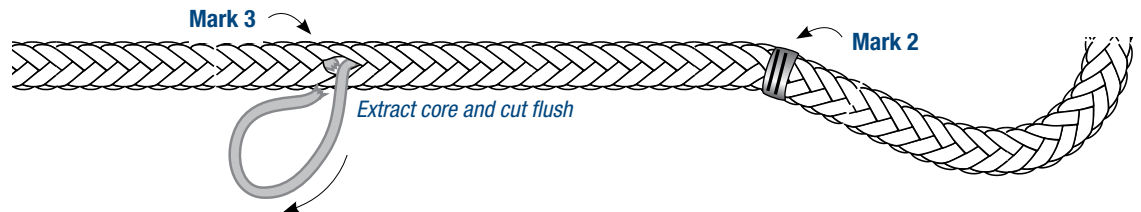

STEP 2 PAIRING THE STRANDS

Divide the 12 individual strands into 6 pairs of 2 strands each. The strands that are paired together should be adjacent to each other at the point where the unbraided rope meets the tape wrapped around the rope. There should be 1 "S" strand (strand with clockwise twist) and 1 "Z" strand (strand with counter-clockwise twist) in each pair. Before taping each set of strands together, twist each strand separately to maintain the twist of the fiber.

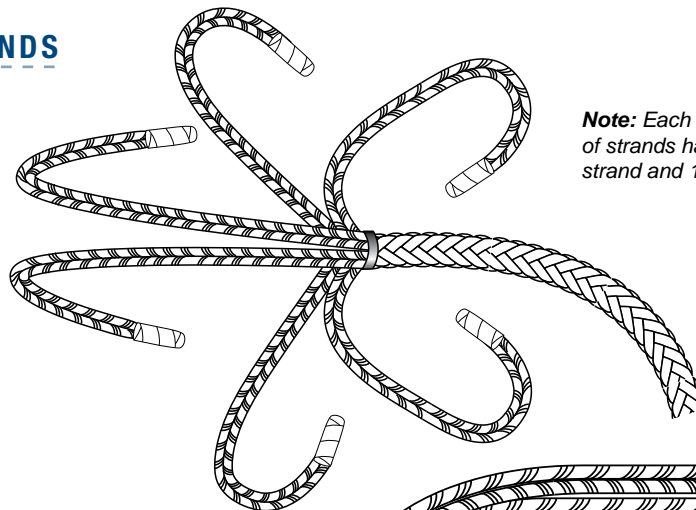

Note: Each taped pair of strands has 1 Z strand and 1 S strand.

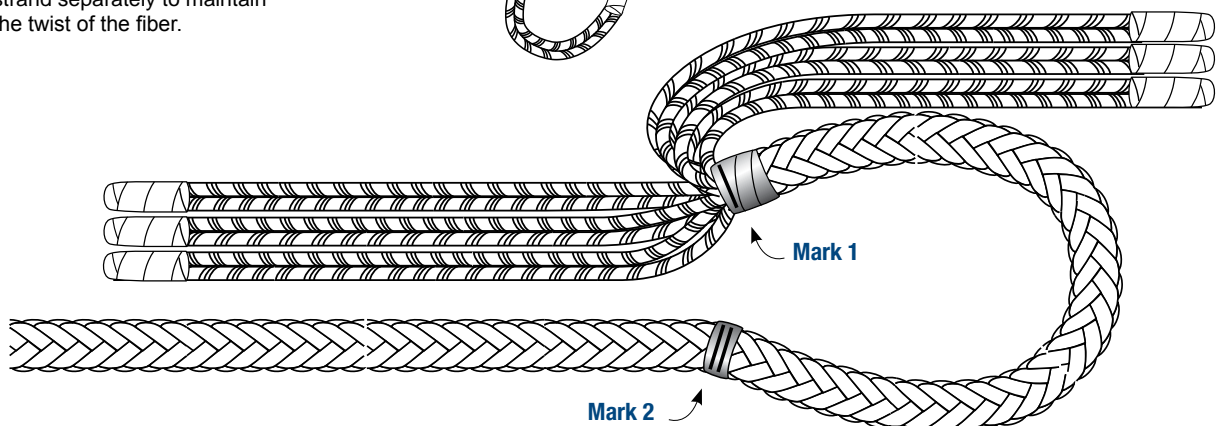



Hi-Tech Purseline Class II Eye Splice

STEP 3 MARKING ENTRY AND EXIT POINTS

At Mark 2, make a mark at the intersection of an S and a Z strand. This will be the entry point for all 6 strands and the tail when it is buried. The entry point should be on the side of the rope facing the opposite leg of the eye.

From the entry point, count 2 picks down the rope and mark 6 strands around the circumference of the rope. There will be 3 S strands and 3 Z strands marked. At each intersection of an S and a Z strand, mark an exit point. There will be 6 exit points marked.

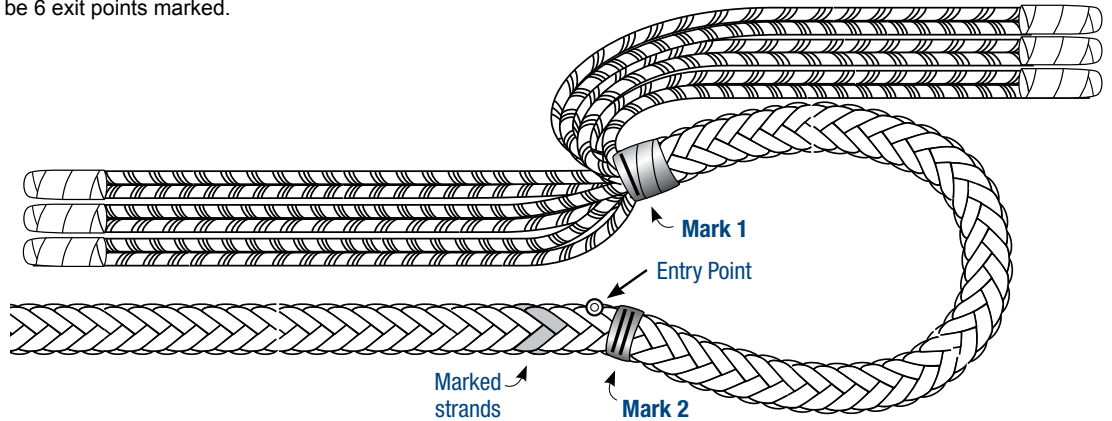
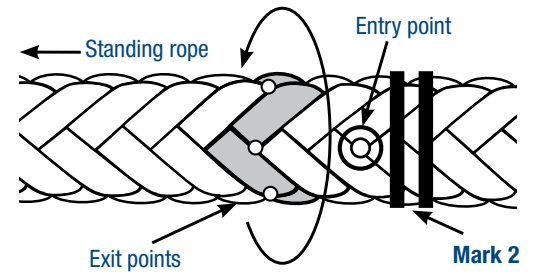

STEP 4 ROUTING THE STRANDS

The first 3 strands closest to the inside of the eye are now routed from the entry point at Mark 2 to the exit points on the opposite side of the rope. Each strand is routed separately, entering at the entry point and exiting at its own exit point. Do not pull the strands up tight yet. Leave slack at the entry point.

4A The 3 remaining strands are now routed from the entry point at Mark 2 to the exit point. Each strand is routed separately, entering at the entry point and exiting at its own exit point. Do not pull the strands up tight yet. Leave slack at the entry point.

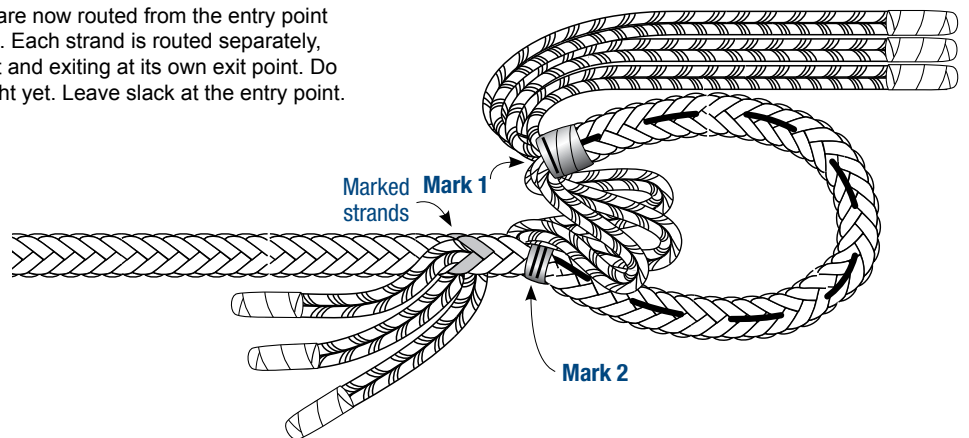

4B With all 6 strands routed, pull each of the 6 routed strands to remove any slack, and make sure the rope is smooth and tight at the entry point.

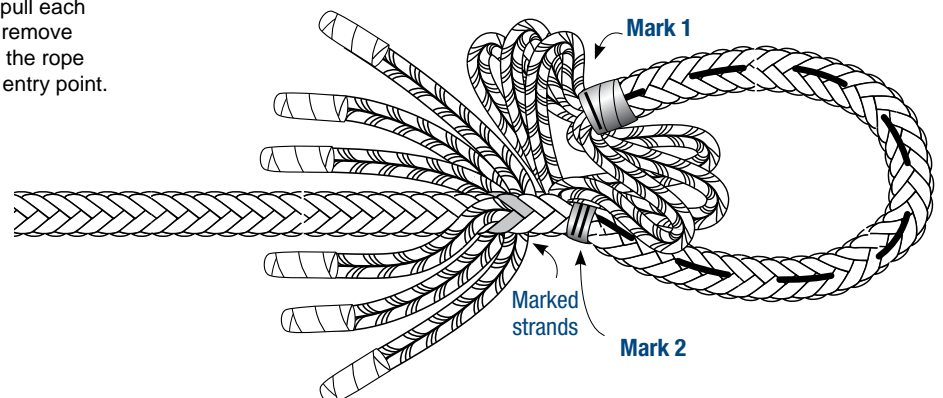



Hi-Tech Purseline Class II Eye Splice

4C When all strand pairs are routed, snug the strands and remove the tape at the base of the tail. Once routed, the strand pairs should have an "X" (overlapping right and left strands) between them or they will touch.

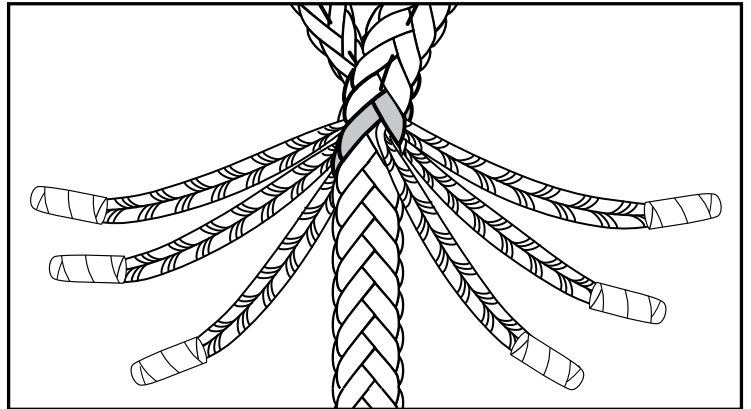

STEP 5 BEGIN TUCKING THE STRAND PAIRS

Begin tucking the strand pairs over 1 and under 2 for 3 tucks. Each strand is tucked down the same row of picks in the braid, over 1 strand and under 2 strands.

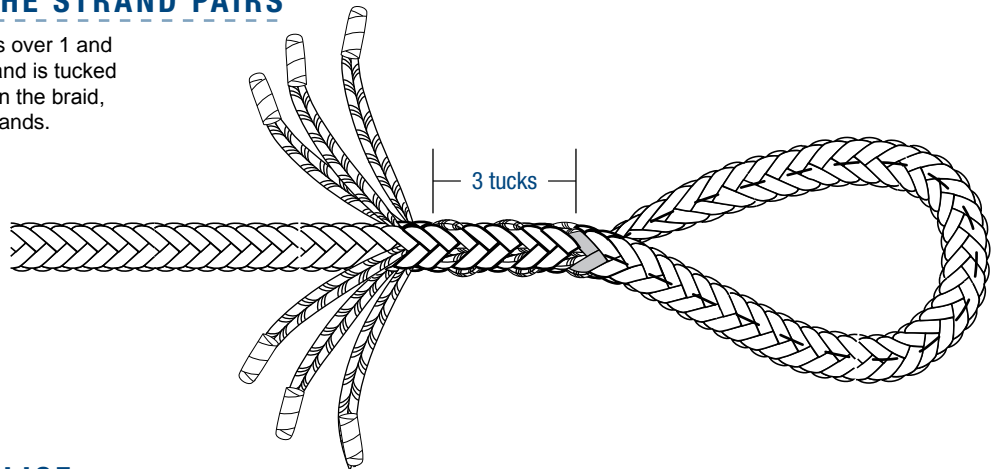

STEP 6 TAPERING THE SPLICE

When all 6 strand pairs have been tucked for 3 tucks, drop every other strand pair. Use the remaining 3 strands to continue down the rope for 3 more tucks.

6A Finally, once 3 of the strand pairs have 6 full tucks, separate the strand pairs into individual strands and drop 1 strand in each pair, continuing down 2 more tucks.

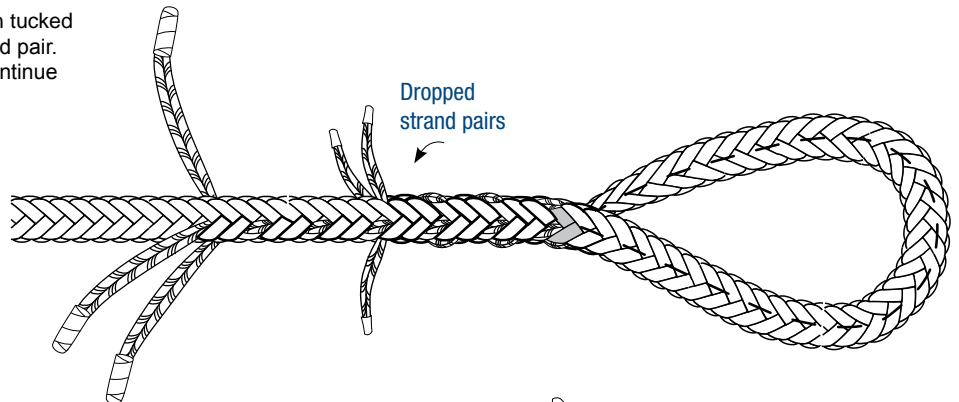

6B Cut the excess tails to complete the splice. Leave enough of an end protruding so that the end does not slip back into the rope when over-loaded.

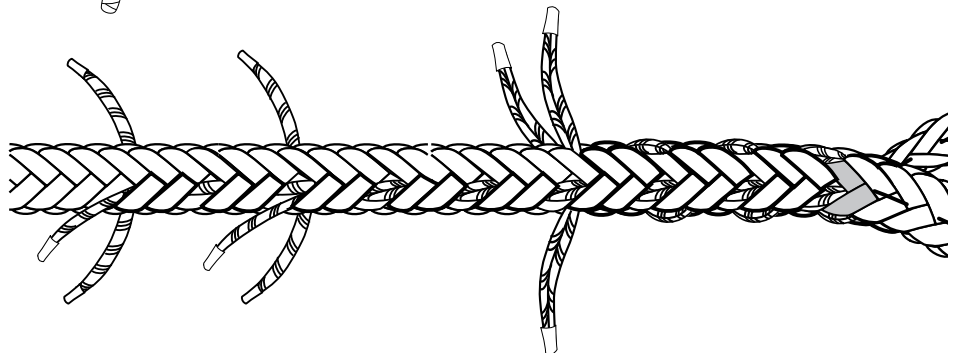



12-Strand Class II Tuck-Bury End-for-End Splice for Saturn-12™

The Tuck-Bury splice is designed as a short splice for Saturn-12 ropes that are 1-1/4" or above in rope diameter

STEP 1 MEASURING AND MARKING

Tape the ends of the ropes to be spliced. Lay Ropes A and B side-by-side and measure 2 tubular fid lengths (4 wire fids) from the taped end of each line and make Mark 1.

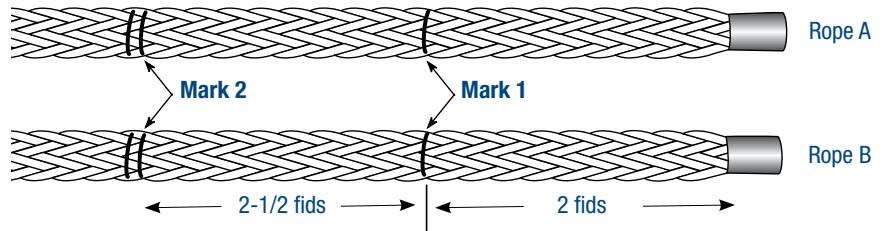

1A From Mark 1, measure 2-1/2 fid lengths and make Mark 2 on both ropes.

STEP 2 TAPERING THE TAIL

At Mark 1, pull out half the strands (3 "S" and 3 "Z") by rotating around the rope, pulling out strands in the pattern shown:

Z Strands = counter clockwise twist
S Strands = clockwise twist

This should leave 6 strands still braided down the middle. Tightly tape the ends of the 6 individual strands, and the end of the remaining braided portion.

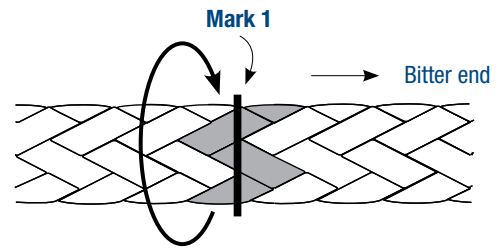

2A On 1 side you should have 2 S and 1 Z and on the other side, 2 Z and 1 S.

STEP 3 ROUTING THE STRANDS

Reposition the ropes for splicing according to the diagram.

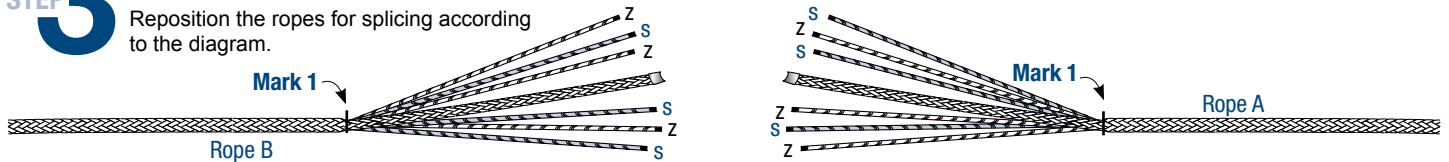

STEP 4 BURYING THE TAIL OF ROPE A INTO ROPE B

From Rope A, pass the 3 closest strands to Rope B through Rope B, 1 or 2 picks down from Mark 1. Do not pull strands all the way through at this stage. The strands enter at the entry point 2 picks from Mark 1, and exit at the exit points 2 picks from the entry point.

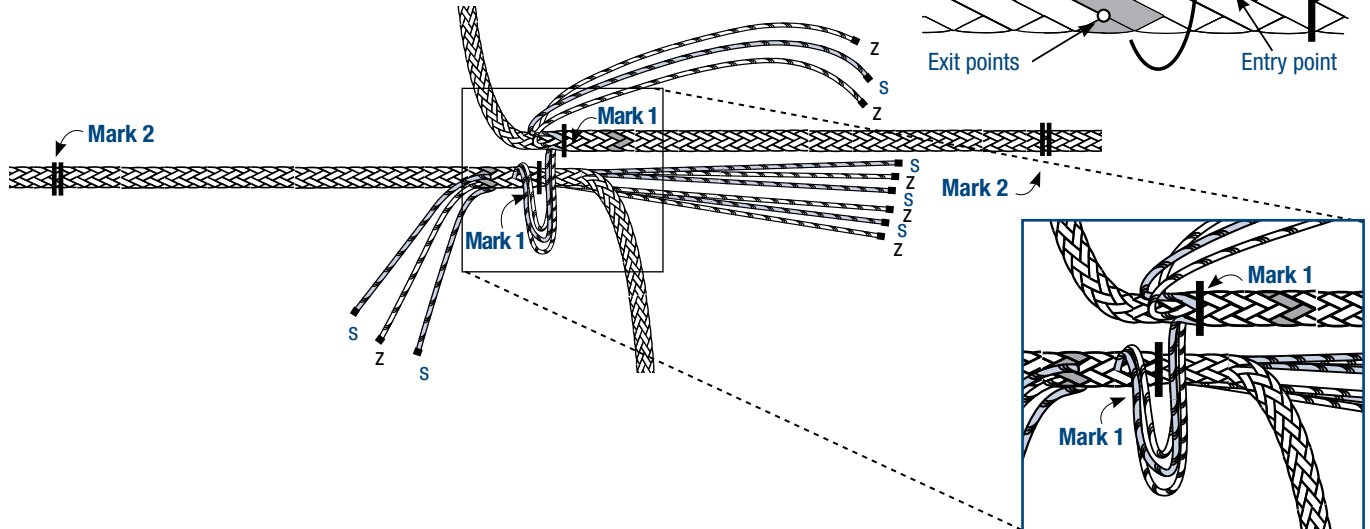
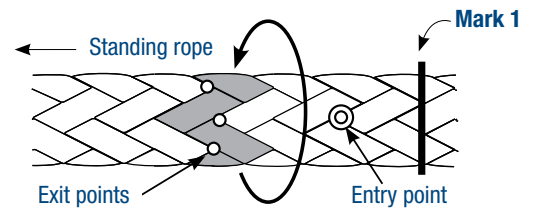



12-Strand Class II Tuck-Bury End-for-End Splice for Saturn-12™

4A Bury the remaining braided strands down the center of the rope, entering at Mark 1 and exiting at Mark 2. The tail should enter the standing part of the rope at the same point where the 3 loose strands passed through. Pull the tail out at Mark 2.

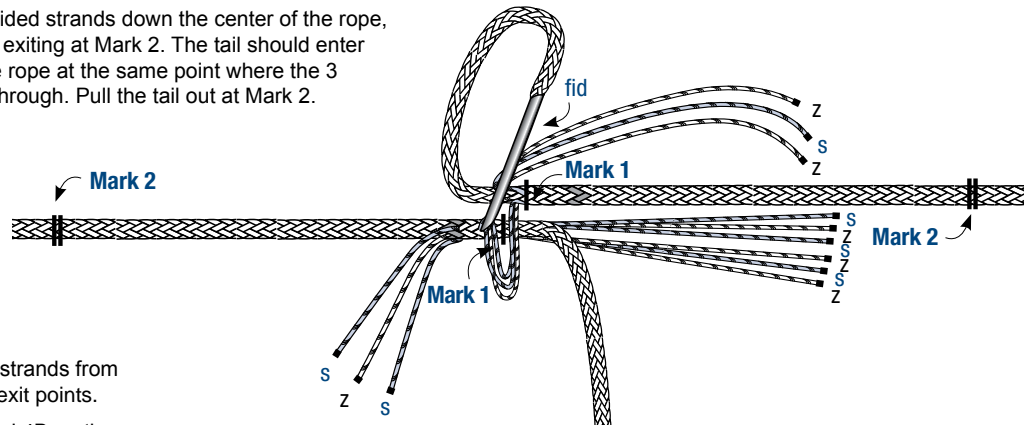

4B Route the remaining 3 strands from the entry point to their exit points. Repeat Steps 4, 4A, and 4B on the opposite end of the rope.

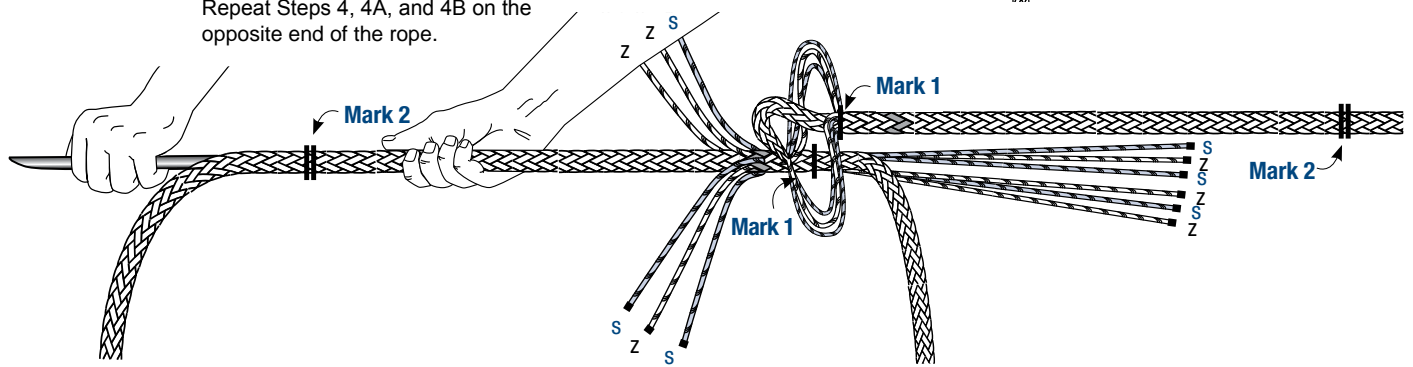

STEP 5 TAPERING THE TAILS

At the end of the tapered tail, remove the fid and any tape at the end of the tail. From the end of the tail, mark 3 consecutive strands, as shown. Pull them out of the braid and cut off close to the body of the rope.

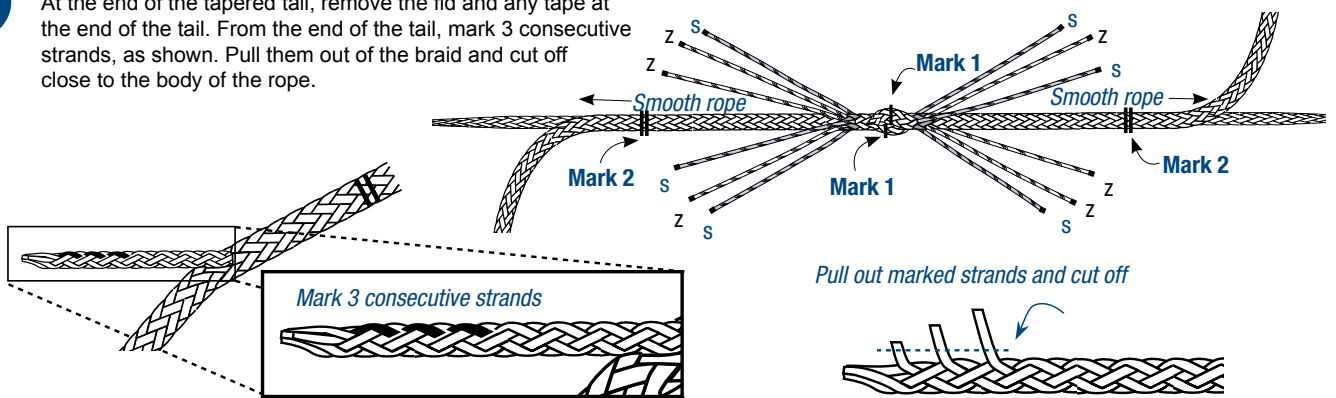

5B Remove the tape from the end of the tails. Now smooth the rope from the crossover toward Mark 2 to bury the tails.

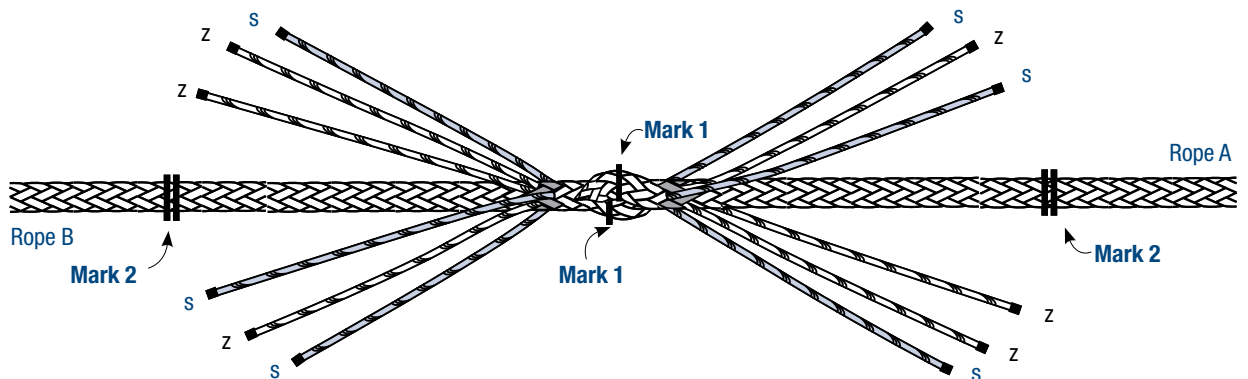



12-Strand Class II Tuck-Bury End-for-End Splice for Saturn-12™

STEP 6 TUCKING THE STRANDS

Tuck the strands from Rope A into Rope B. 1 complete tuck consists of passing a strand over 1 strand and under 2 strands.

Do 5 complete tucks for all 6 strands. Each strand is always tucked under the same line of the braid so that the tucks progress straight down the body of the rope.

After completing the first 5 tucks, remove half the volume of the twisted yarns from each of the 6 strands near the taped ends, and complete 3 more tucks with the reduced-volume strands.

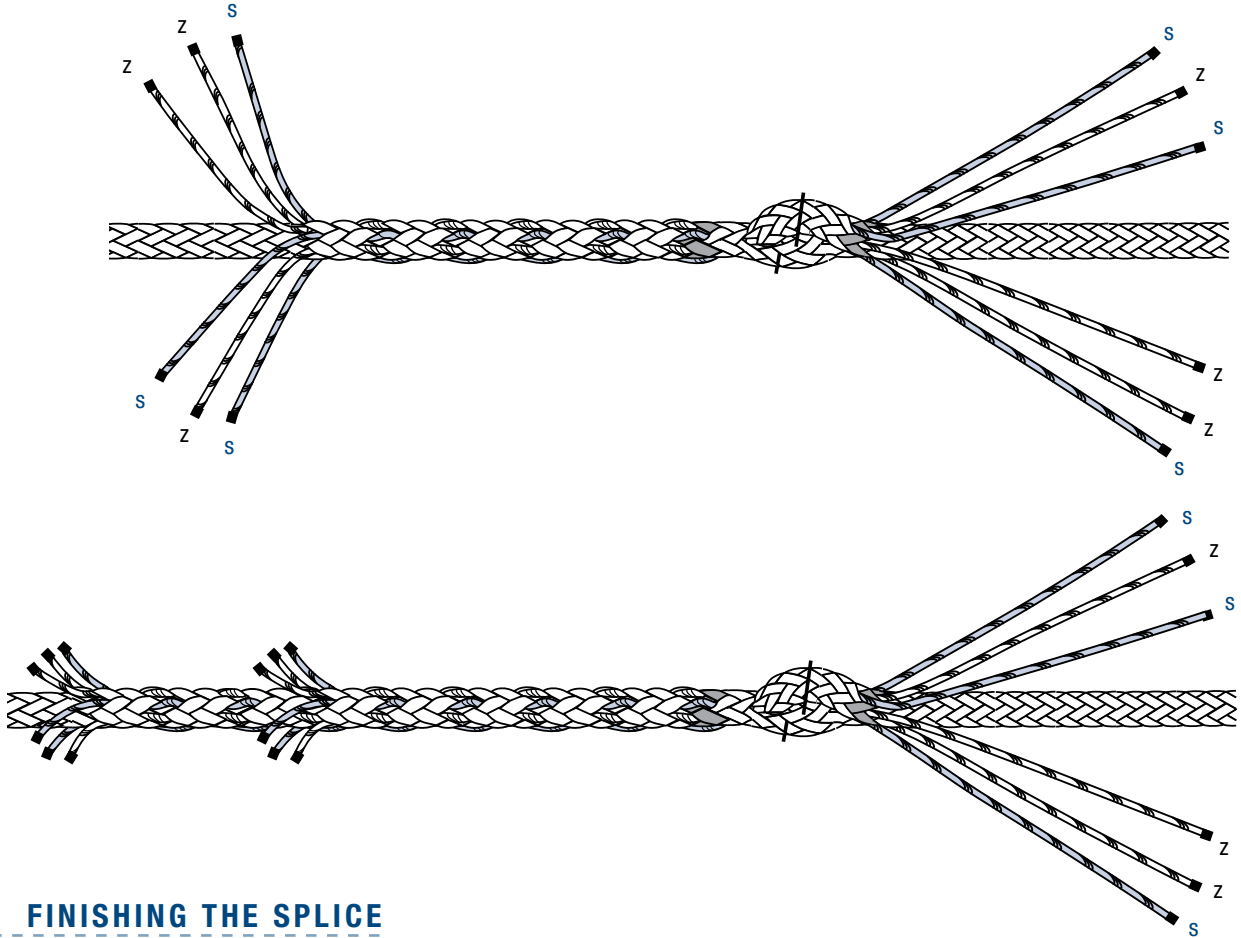

STEP 7 FINISHING THE SPLICE

After completing the second set of 3 tucks, cut off the excess material and tape the ends. Leave enough of an end protruding so it does not slip back into the rope when the rope is loaded.

Follow Steps 5 and 6 until all tails are tucked.

Your finished Tuck-Bury End-for-End Splice will look like this:

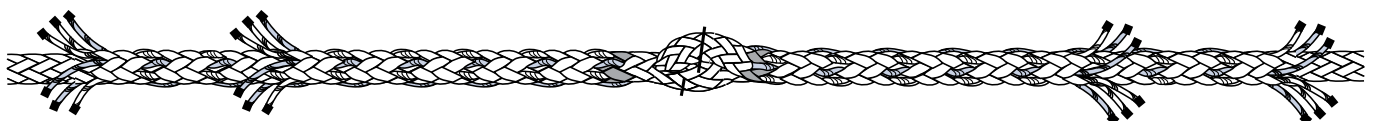

Finished splice



12-Strand Class II Tuck-Bury End-For-End Splice

samson
THE STRONGEST NAME IN ROPE

The Tuck-Bury splice is designed as a short splice for Class II 12-strand ropes only.

STEP 1 MEASURING AND MARKING

Tape the ends of the ropes to be spliced. Lay Ropes A and B side-by-side and measure 1-1/2 tubular fid lengths, from the taped end of each line and make Mark 1.

1A From Mark 1, measure 2 fid lengths and make Mark 2 on both ropes.

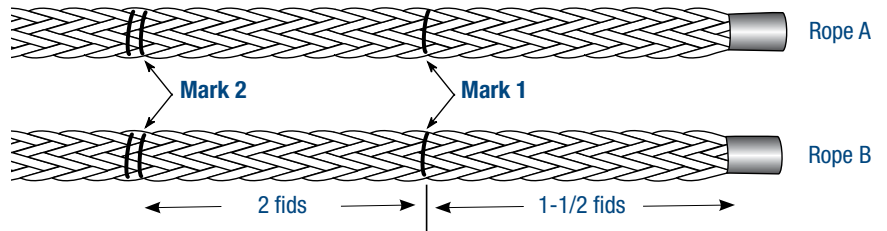

STEP 2 TAPERING THE TAIL

At Mark 1, pull out half the strands (3 "S" and 3 "Z") by rotating around the rope, pulling out strands in the pattern shown:

Z Strands = counter clockwise twist
S Strands = clockwise twist

This should leave 6 strands still braided down the middle. Tightly tape the ends of the 6 individual strands, and the end of the remaining braided portion.

2A On 1 side you should have 2 S and 1 Z and on the other side, 2 Z and 1 S.

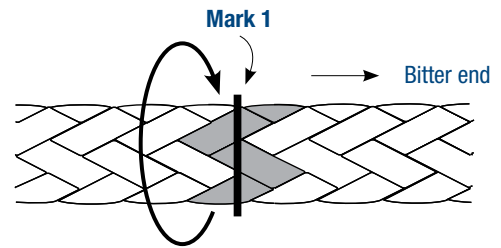

STEP 3 ROUTING THE STRANDS

Reposition the ropes for splicing according to the diagram.

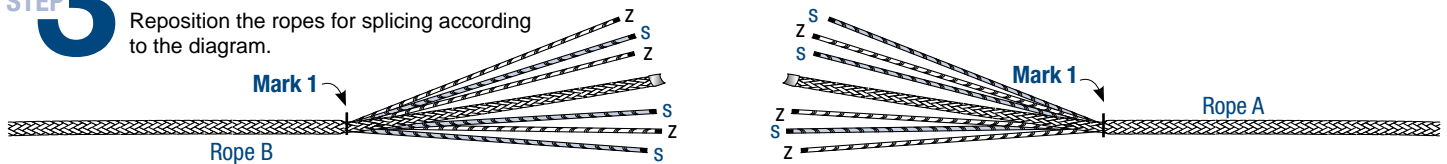

STEP 4 BURYING THE TAIL OF ROPE A INTO ROPE B

From Rope A, pass the 3 closest strands to Rope B through Rope B, 1 or 2 picks down from Mark 1. Do not pull strands all the way through at this stage. The strands enter at the entry point 2 picks from Mark 1, and exit at the exit points 2 picks from the entry point.

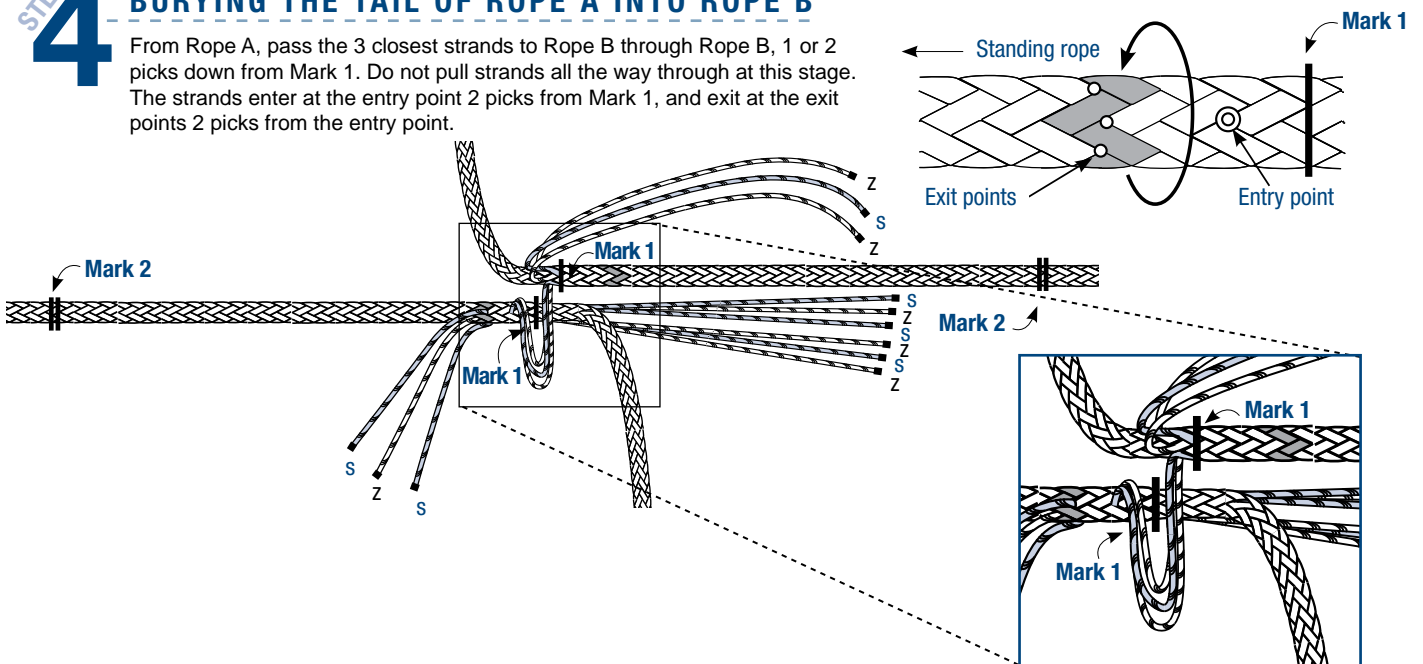



12-Strand Class II Tuck-Bury End-For-End Splice

samson
THE STRONGEST NAME IN ROPE

4A Bury the remaining braided strands down the center of the rope, entering at Mark 1 and exiting at Mark 2. The tail should enter the standing part of the rope at the same point where the 3 loose strands passed through. Pull the tail out at Mark 2.

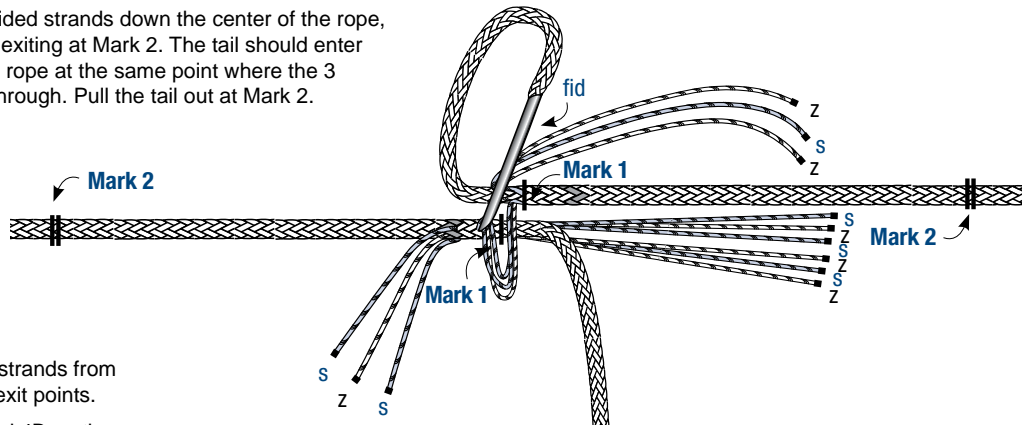

4B Route the remaining 3 strands from the entry point to their exit points.

Repeat Steps 4, 4A, and 4B on the opposite end of the rope.

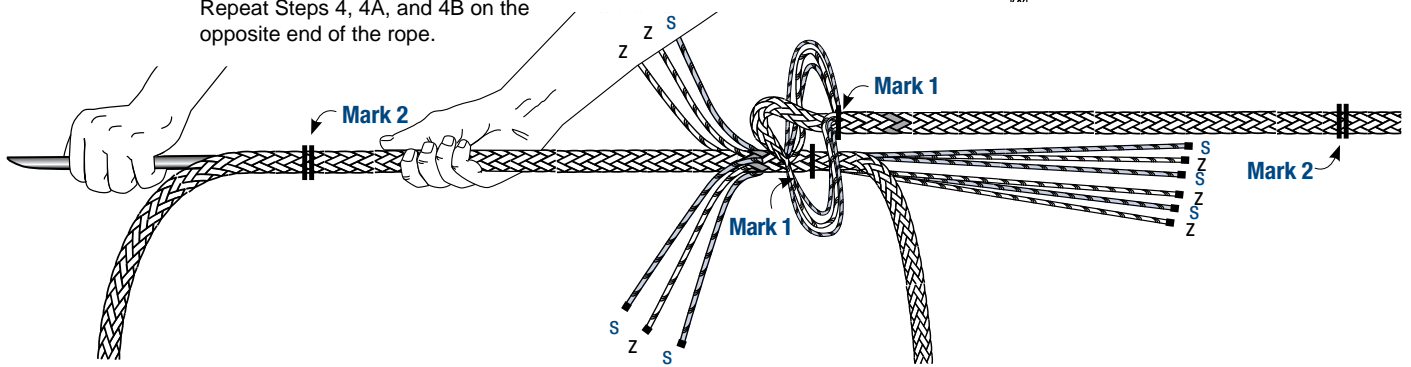

STEP 5 TAPERING THE TAILS

At the end of the tapered tail, remove the fid and any tape at the end of the tail. From the end of the tail, mark 3 consecutive strands, as shown. Pull them out of the braid and cut off close to the body of the rope.

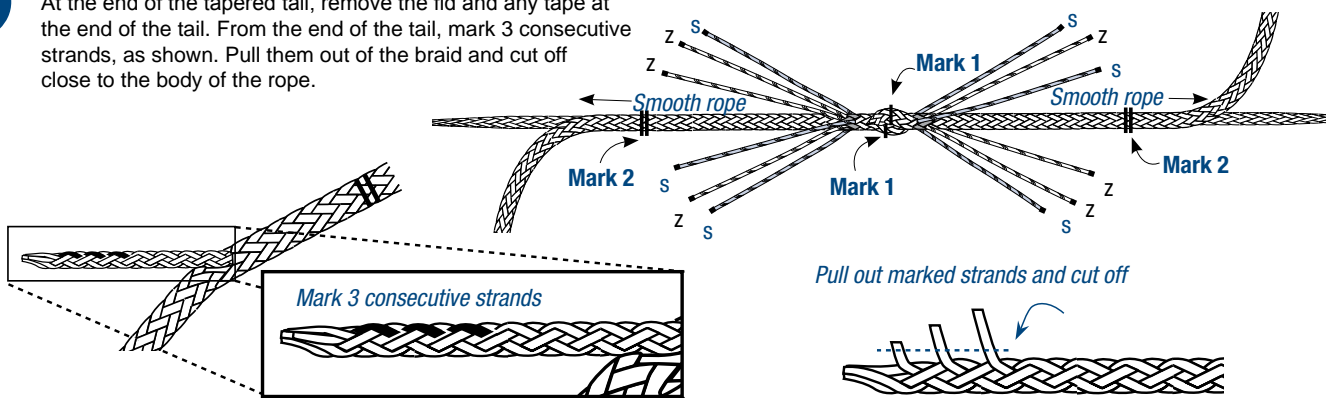

5B Remove the tape from the end of the tails. Now smooth the rope from the crossover toward Mark 2 to bury the tails.

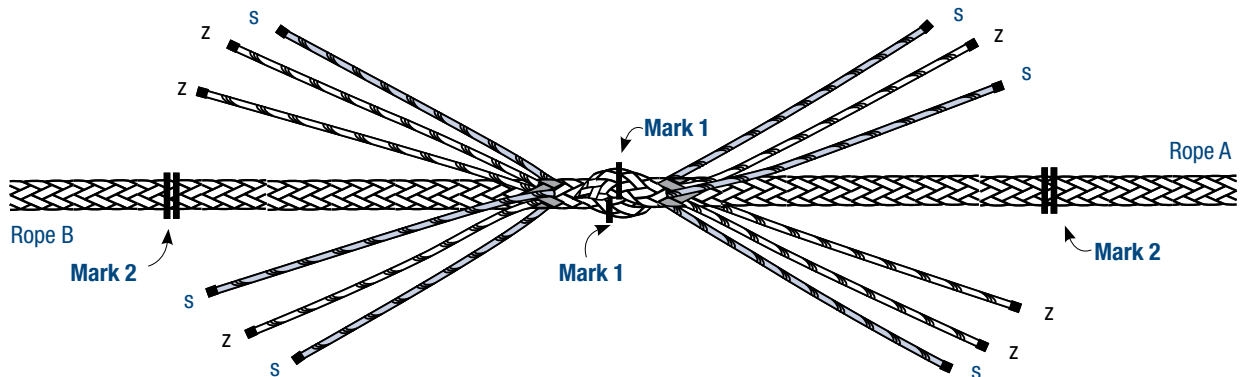



12-Strand Class II Tuck-Bury End-For-End Splice

STEP 6 TUCKING THE STRANDS

Tuck the strands from Rope A into Rope B. 1 complete tuck consists of passing a strand over 1 strand and under 2 strands.

Do 3 complete tucks for all 6 strands. Each strand is always tucked under the same line of the braid so that the tucks progress straight down the body of the rope.

After completing the first 3 tucks, remove half the volume of the twisted yarns from each of the 6 strands near the taped ends, and complete 3 more tucks with the reduced-volume strands.

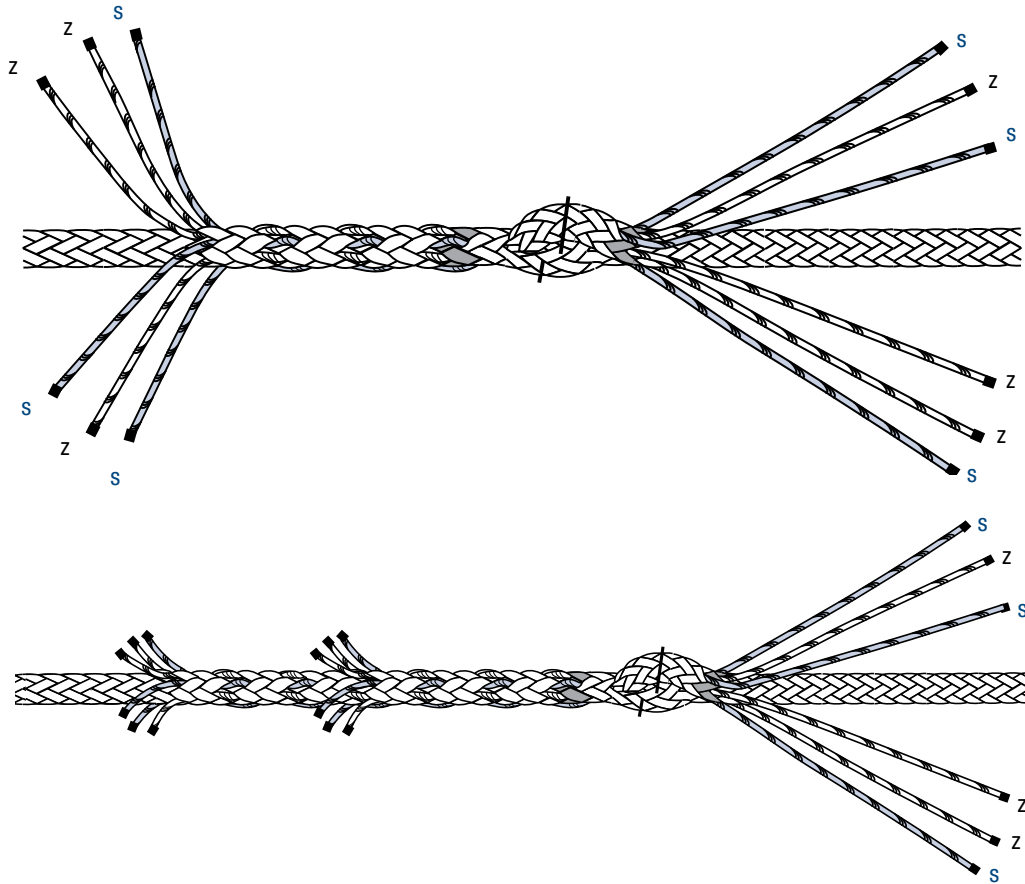

STEP 7 FINISHING THE SPLICE

After completing the second set of 3 tucks, cut off the excess material and tape the ends. Leave enough of an end protruding so it does not slip back into the rope when the rope is loaded.

Follow Steps 5 and 6 until all tails are tucked.

Your finished Tuck-Bury End-for-End Splice will look like this:

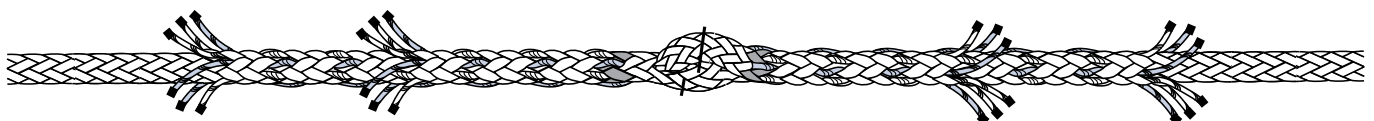

Finished splice



12-Strand Class II Tuck-Bury Eye Splice

The Tuck-Bury splice is designed as a short splice for HMPE (Dyneema® fiber) 12-strand ropes only.

STEP 1 MEASURING AND MARKING

Tape end to be spliced. Measure 1-1/2 fid lengths from the bitter end and mark. This is Mark 1. Put tight tape wrap at Mark 1.

1A From Mark 1, form a loop the size of the eye desired and mark. This is Mark 2.

1B From Mark 2, measure down the rope 2 fids and mark. This is Mark 3.

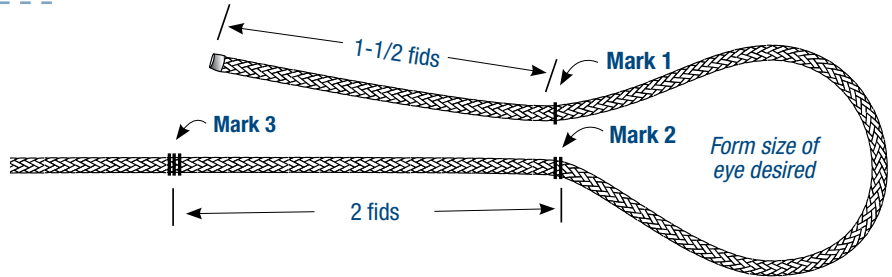

STEP 2 TAPERING THE TAIL

At Mark 1, pull out half the strands (3 "S" and 3 "Z") by rotating around the rope and pulling out strands in the pattern shown:

Z Strand = counter-clockwise twist
S Strand = clockwise twist

This should leave 6 strands still braided down the middle. Tightly tape the ends of the 6 individual strands, as well as the end of the remaining braided portion.

On one side you should have 2 S strands and 1 Z strand. On the other side, you should have 2 Z strands and 1 S strand.

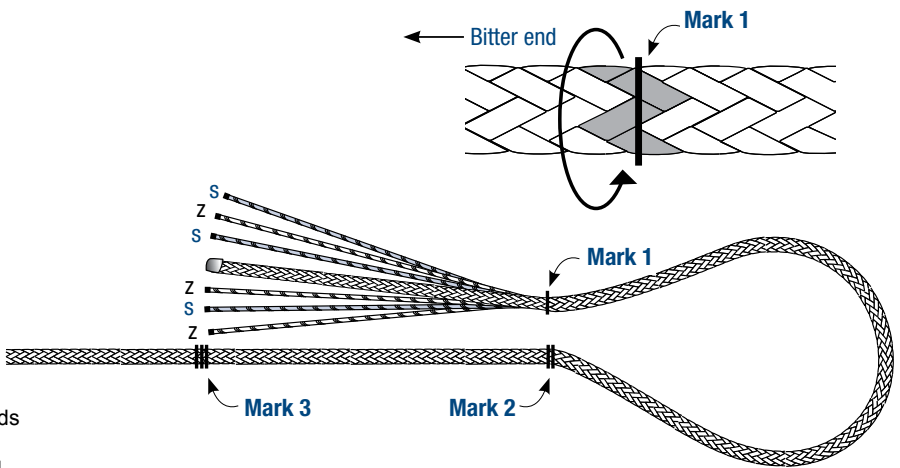

STEP 3 ROUTING THE STRANDS

3A MARKING ENTRY AND EXIT POINTS

Make a mark at the intersection of an S and a Z strand at Mark 2. This will be the entry point for all 6 strands and the tail when it is buried. The entry point should be on the side of the rope facing the opposite leg of the eye.

From the entry point, count 2 picks down the rope and mark 6 strands around the circumference of the rope. There will be 3 S strands and 3 Z strands marked. At each intersection of an S and a Z strand, mark an exit point. There will be 6 exit points marked.

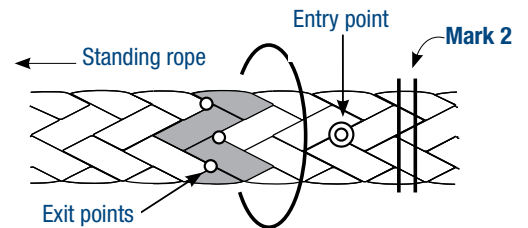

3B ROUTING 3 STRANDS

The first 3 strands are now routed from the entry point at Mark 2 to the exit point. Each strand is routed separately, entering at the entry point and exiting at its own exit point. Do not pull the strands up tight yet. Leave slack at the entry point.

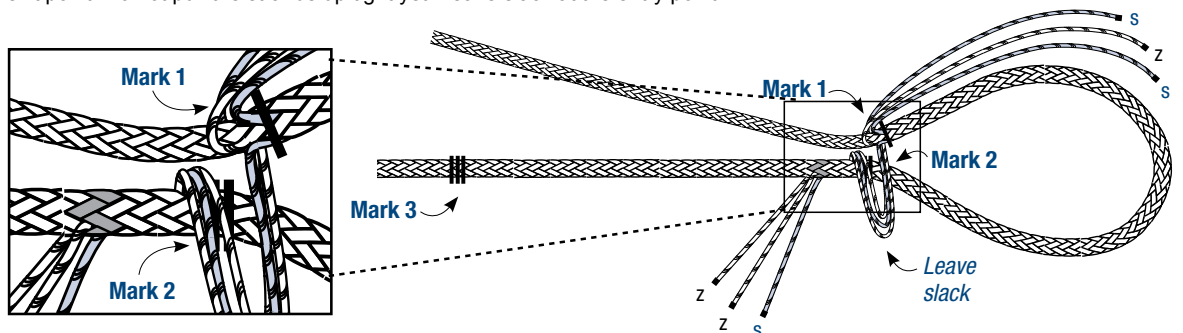



12-Strand Class II Tuck-Bury Eye Splice

3C BURYING THE TAIL

Attach a fid to the end of the tapered tail and bury it from the entry point through the rope to exit beyond Mark 3. Leave the tail exposed.

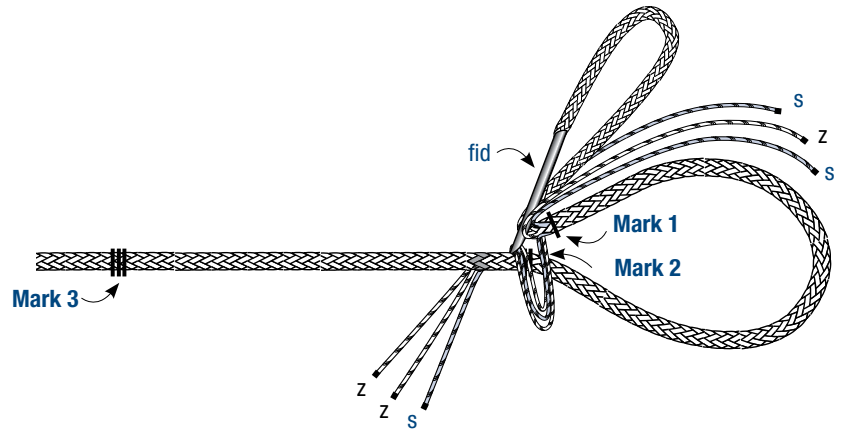

3D ROUTING LAST 3 STRANDS

The 3 remaining strands are now routed from the entry point at Mark 2 to the exit point. Each strand is routed separately, entering at the entry point and exiting at its own exit point. Do not pull the strands tight yet. Leave slack at the entry point.

Now that all 6 strands are routed and the tail is buried, pull each of the strands to remove any slack. Make sure the rope is smooth and tight at the entry point.

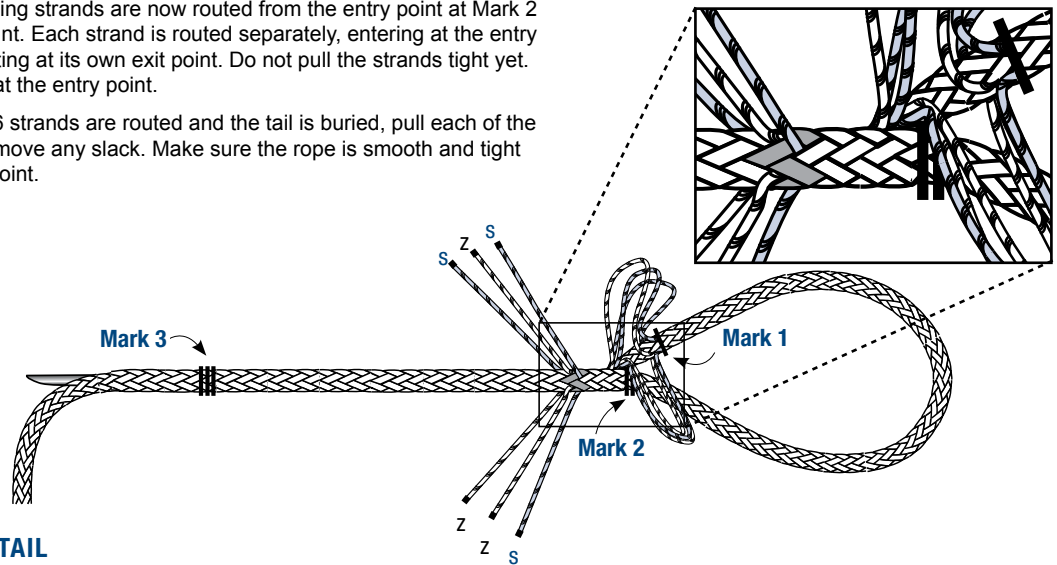

3E TAPERING TAIL

At Mark 3, pull the tail out until Marks 1 and 2 meet. Pull any slack out of the 6 strands that are routed. Pull out the tail and mark 3 consecutive strands as shown. Pull out all 3 and cut.

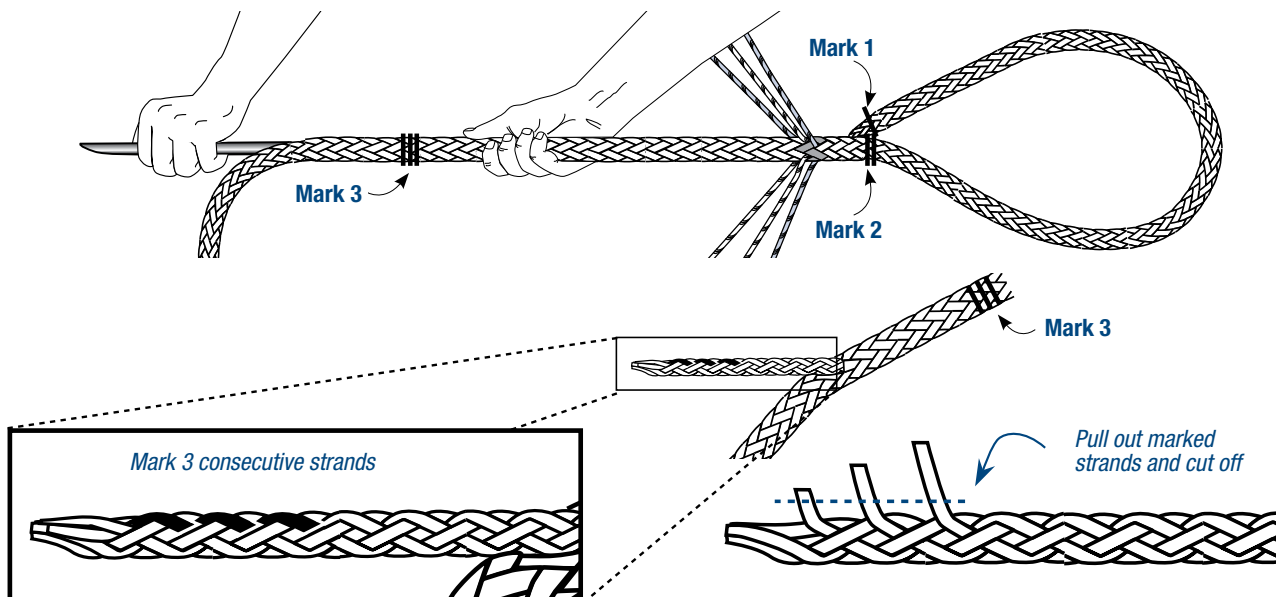



12-Strand Class II Tuck-Bury Eye Splice

3F SMOOTHING SLACK OVER TAPER

Remove the tape from the end of the tail. Now smooth the rope from the eye towards Mark 3, the tail will disappear into the rope. Smooth the rope to remove any remaining slack. Check that the 6 routed strands are snug.

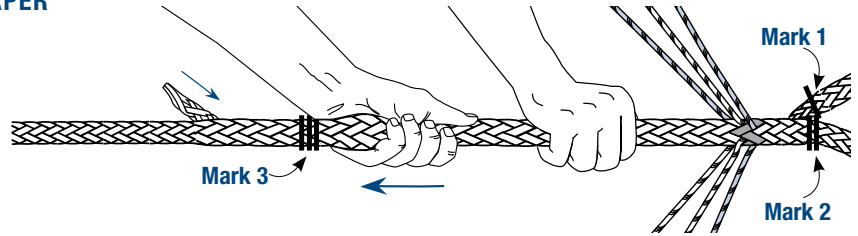

STEP 4 TUCKING THE STRANDS

The strands are now tucked into the braid of the rope. 1 complete tuck consists of passing a strand over 1 strand and under 2 strands. The tucks proceed down the same row of picks straight down the body of the rope.

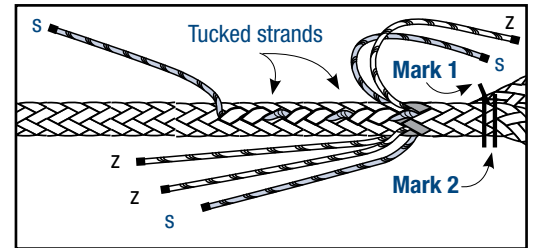
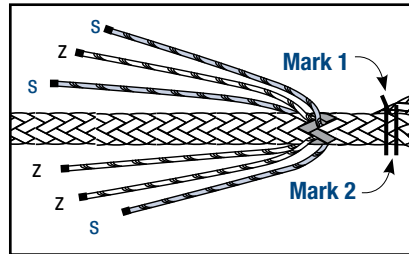

4A Do 3 complete tucks for all 6 strands. Each strand is always tucked under the same line of the braid so that the tucks progress straight down the body of the rope.

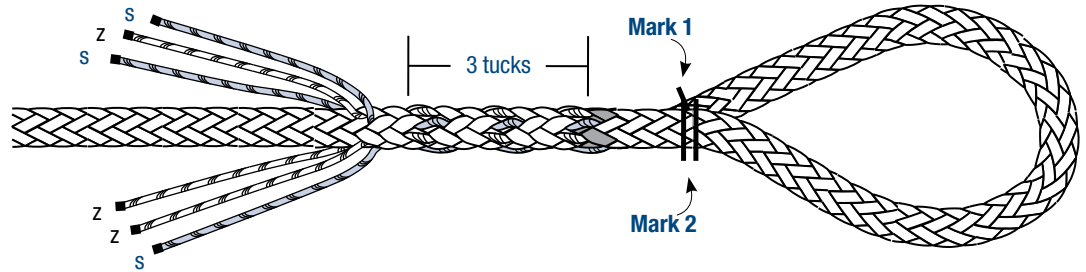

4B After completing the first 3 tucks, remove 1/2 of the volume of the twisted yarns. Cut yarns from each of the 6 strands near the taped ends and complete 3 more tucks with the reduced volume strands.

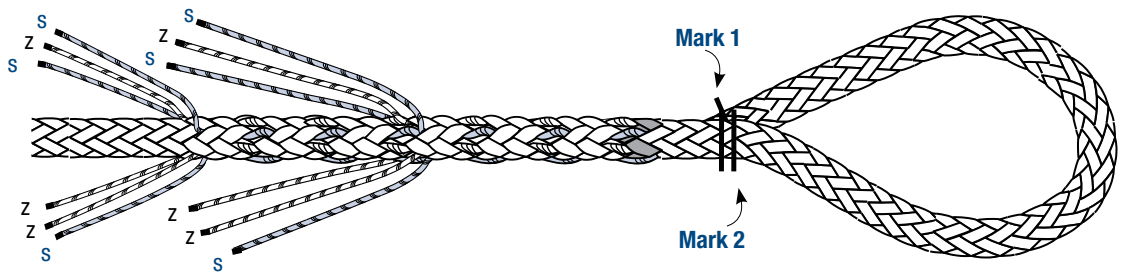

STEP 5 FINISHING THE SPLICE

After completing the second set of 3 tucks, cut off the excess material and tape the ends. Leave enough of an end protruding so that it does not slip back into the rope when the rope is loaded.

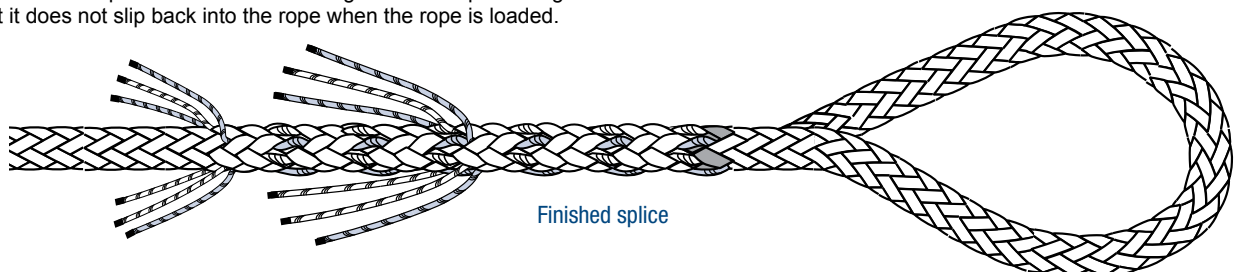



12-Strand Class II Tuck-Bury Eye Splice for Saturn-12™

samson
THE STRONGEST NAME IN ROPE

This is a modification to the standard HMPE Tuck-Bury 12-strand splice to increase splice length on Saturn-12. This modification must be used on Saturn-12 products larger than 1-1/8" in diameter.

STEP 1 MEASURING AND MARKING

Tape end to be spliced. Then measure 2 fid lengths from the bitter end and mark. This is Mark 1. Wrap tape tightly around the rope at Mark 1.

1A From Mark 1, form a loop the size of the eye desired and mark. This is Mark 2.

1B From Mark 2, measure down the rope 2-1/2 fid lengths and mark. This is Mark 3.

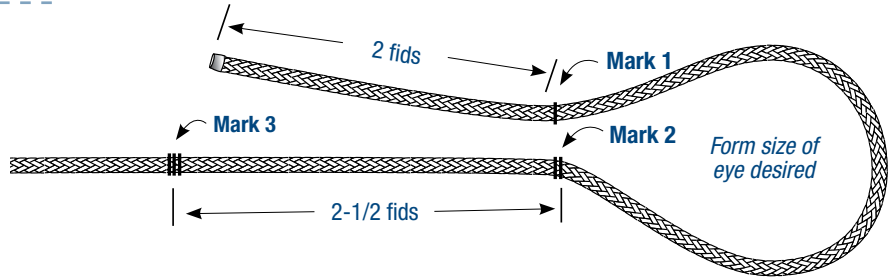

STEP 2 TAPERING THE TAIL

At Mark 1, pull out half the strands (3 "S" and 3 "Z") by rotating around the rope and pulling out strands in the pattern shown:

Z strand = counter-clockwise twist
S strand = clockwise twist

This should leave 6 strands still braided down the middle. Tightly tape the ends of the 6 individual strands, as well as the end of the remaining braided portion.

On one side you should have 2 S strands and 1 Z strand. On the other side, you should have 2 Z strands and 1 S strand.

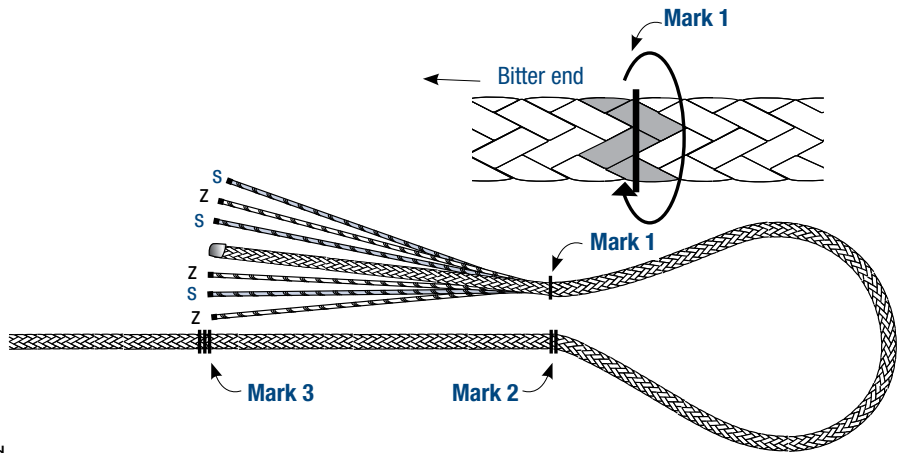

STEP 3 ROUTING THE STRANDS

3A MARKING ENTRY AND EXIT POINTS

At Mark 2, make a mark at the intersection of an S and a Z strand. This will be the entry point for all 6 strands and the tail when it is buried. The entry point should be on the side of the rope facing the opposite leg of the eye.

From the entry point, count 2 picks down the rope and mark 6 strands around the circumference of the rope. There will be 3 S strands and 3 Z strands marked. At each intersection of an S and a Z strand, mark an exit point. There will be 6 exit points marked.

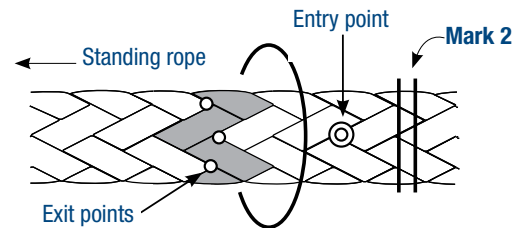

3B ROUTING 3 STRANDS

The first 3 strands are now routed from the entry point at Mark 2 to the exit point. Each strand is routed separately, entering at the entry point and exiting at its own exit point. Do not pull the strands up tight yet. Leave slack at the entry point.

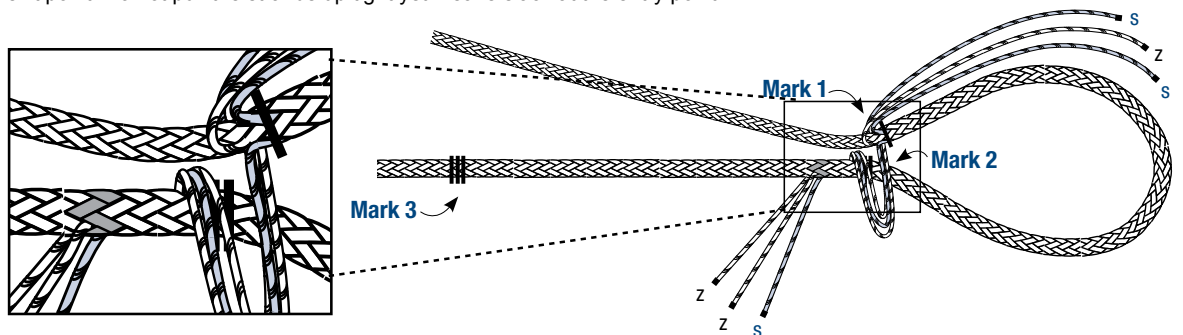



12-Strand Class II Tuck-Bury Eye Splice for Saturn-12™

samson
THE STRONGEST NAME IN ROPE

3C BURYING THE TAIL

Attach a fid to the end of the tapered tail and bury it from the entry point through the rope to exit beyond Mark 3. Pull the tail until Marks 1 and 2 meet. Leave the tail exposed.

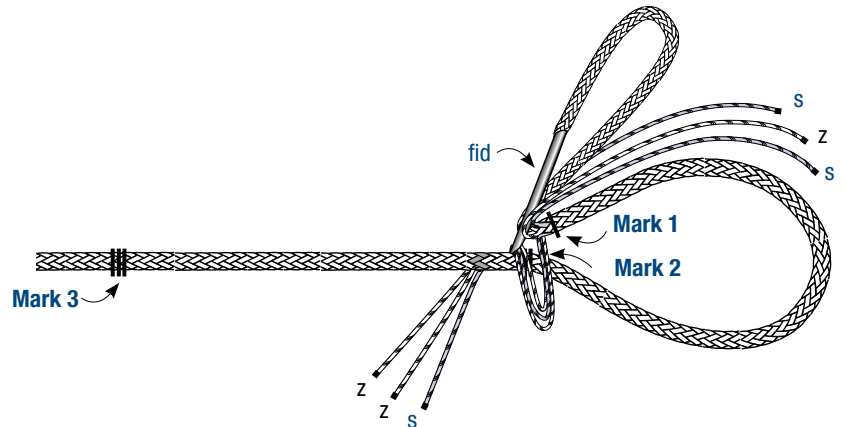

3D ROUTING LAST 3 STRANDS

The 3 remaining strands are now routed from the entry point at Mark 2 to the exit point. Each strand is routed separately, entering at the entry point and exiting at its own exit point. Do not pull the strands up tight yet. Leave slack at the entry point.

With all 6 strands routed and the tail buried, pull each of the 6 routed strands to remove any slack, and make sure the rope is smooth and tight at the entry point.

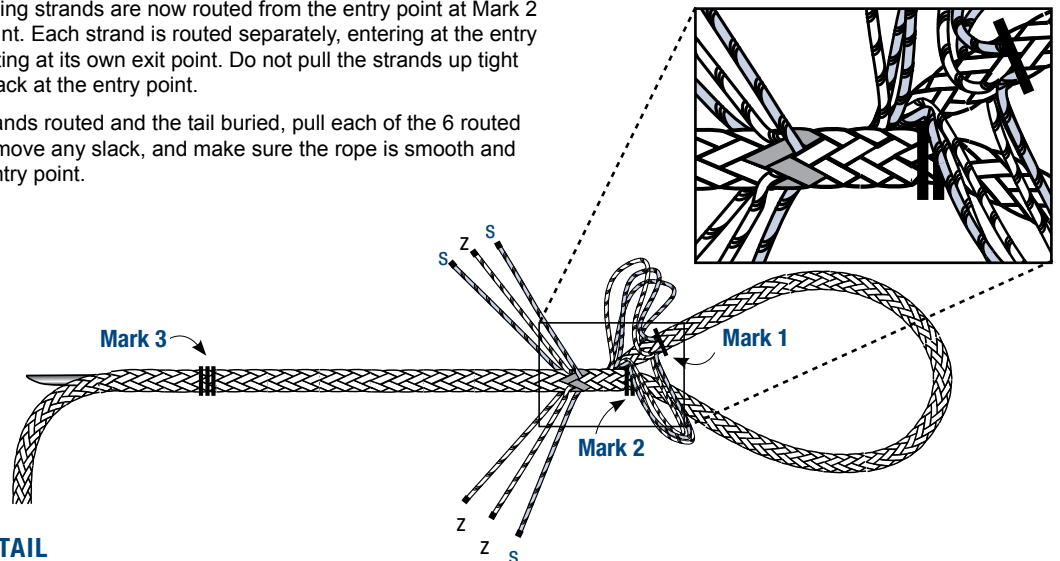

3E TAPERING TAIL

At Mark 3, pull the tail out until Marks 1 and 2 meet. Pull any slack out of the 6 strands that are routed. Pull out the tail and mark 3 consecutive strands as shown. Pull out all 3 and cut off.

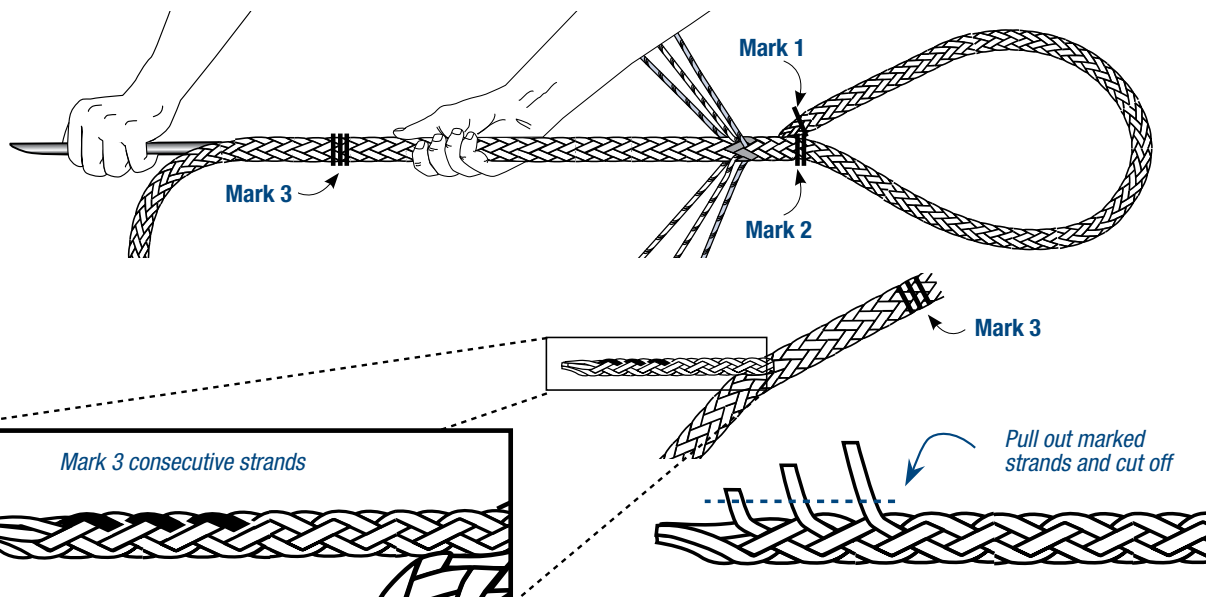



12-Strand Class II Tuck-Bury Eye Splice for Saturn-12™

samson
THE STRONGEST NAME IN ROPE

3F SMOOTHING SLACK OVER TAPER

Remove the tape from the end of the tail. Now smooth the rope from the eye towards Mark 3. The tail will disappear into the rope. Smooth the rope to remove any remaining slack. Check that the 6 routed strands are snug.

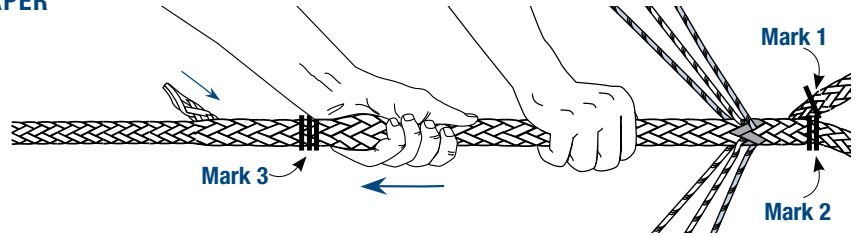

STEP 4 TUCKING THE STRANDS

The strands are now tucked into the braid of the rope. 1 complete tuck consists of passing a strand over 1 strand and under 2 strands. The tucks proceed down the same row of picks straight down the body of the rope.

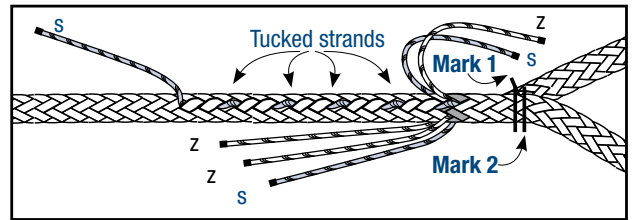
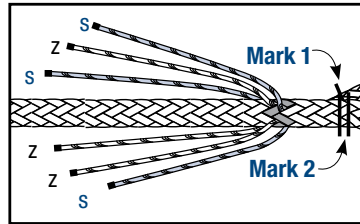

4A Do 5 complete tucks for all 6 strands. Each strand is always tucked under the same line of the braid so that the tucks progress straight down the body of the rope.

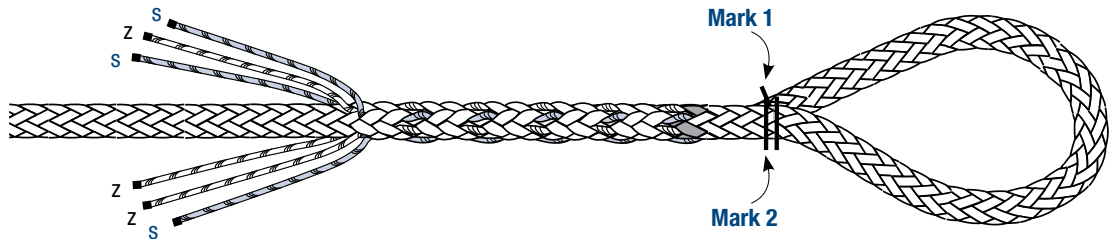

4B After completing the first 5 tucks, remove 1/2 of the volume of the twisted yarns. Cut yarns from each of the 6 strands near the taped ends and complete 3 more tucks with the reduced volume strands.

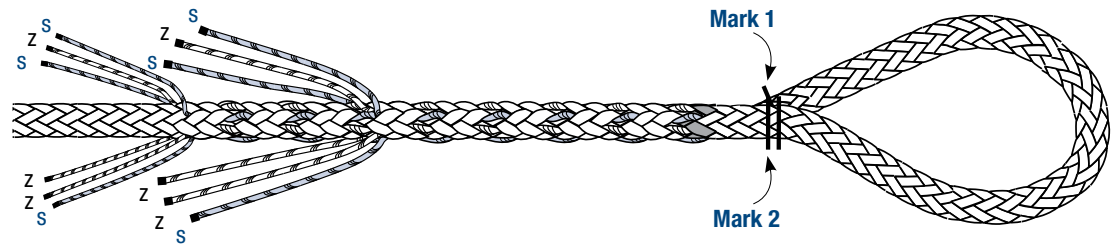

STEP 5 FINISHING THE SPLICE

After completing the second set of 3 tucks, cut off the excess strands and tape the ends. Leave enough of an end protruding so that the end does not slip back into the rope when the rope is loaded.

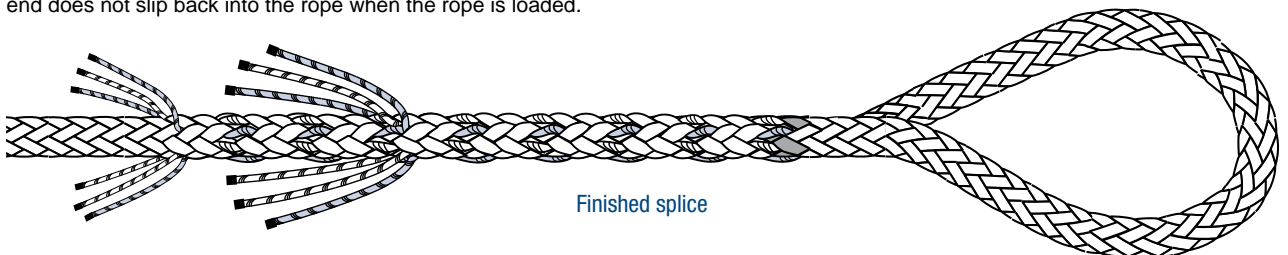

SAMSON SPLICING INSTRUCTIONS



samson
THE STRONGEST NAME IN ROPE

12-Strand Class II Whoopie Sling for AmSteel®/AmSteel®-Blue

AmSteel® and AmSteel®-Blue Whoopie Slings have a break strength of 70% of the published average rope break strength.

Note: For longer sling lengths, determine length needed beyond the maximum length listed in table to right. Multiply the length needed by two and add resulting amount to cut length. For example: If you need a maximum length of 12 ft. on a 3/4 inch sling, this is 2 ft. longer than the listed max length. Multiply 2 ft. x 2 = 4 ft. Add this to the original cut length (4 ft. + 24 ft. = 28 ft.). Your cut length will need to be 28 ft. to make a sling that adjusts to 12 ft.

STEP 1 SPLICING FIXED EYE

Using these measurements do the **Locked Brummel Splice**. Directions are as follows:

CUT LENGTHS FOR SLINGS:

Rope Size	Cut Length	Sling Adjusts From/To
1/2"	17-1/2'	5-1/2' to 8'
5/8"	20'	7' to 9'
3/4"	24'	7-1/2' to 10'

All slings use the same measurements with proper size fid.

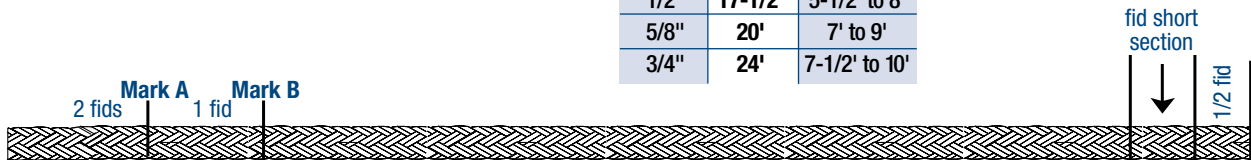

1A Leave tail at full volume. Just cut end at an angle, then tape.

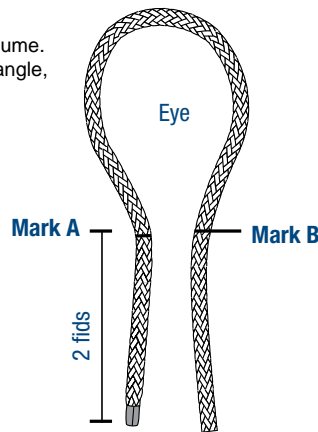

1B Pass end through center of rope at Mark B. Do not bury Mark A, leave on entry side of standing rope.

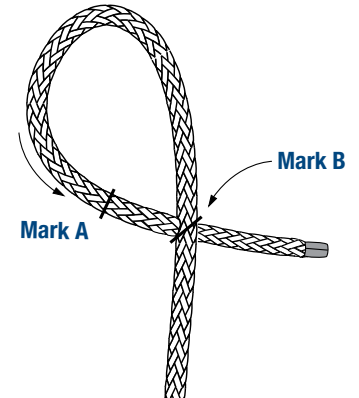

1C Pass the opposite end through the center of the tail approximately 2 picks from where it exits the standing rope.

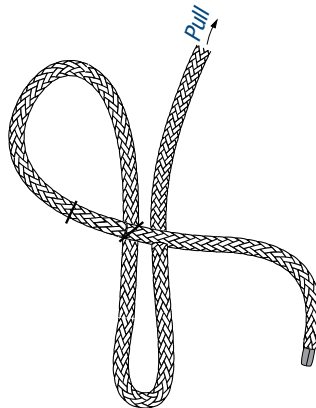

1D Close up Brummel.

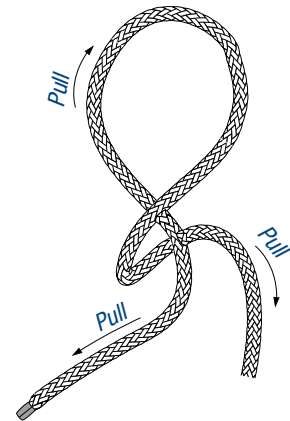

1E To bury the tail into the standing end, make a mark approximately 2 picks from where the standing part passes through the tail (Mark C). This will be the tail entry point. From Mark C, measure down the standing part 2-1/4 fid lengths and make Mark D. Insert fid and tapered tail at Mark C and bring out at Mark D. Remove fid and smooth the standing part out, which will bury the entire tail.

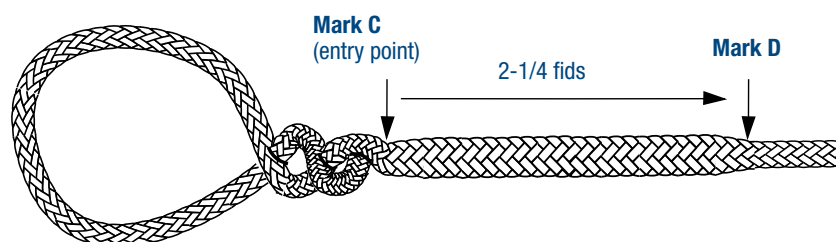



12-Strand Class II Whoopie Sling for AmSteel®/AmSteel®-Blue

STEP 2 CREATING ADJUSTABLE LOOP

2A From Mark D measure 3-1/2 fids and make Mark E.

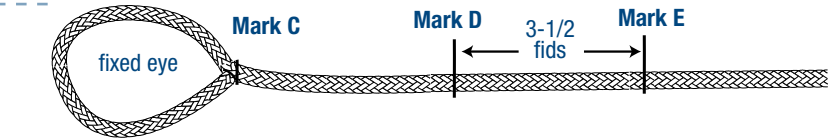

2B Attach end of rope to a fid and pass the fid and tail in at Mark E and out of Mark D. Pull the tail end through the buried portion and leave the tail exposed.

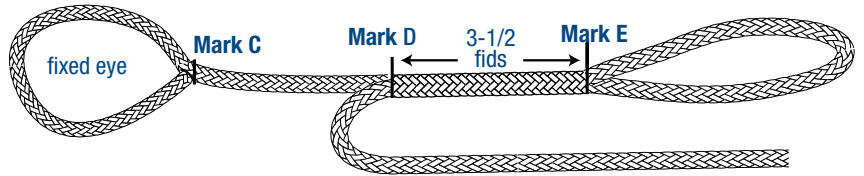

STEP 3 BACK SPLICING THE END

From the unspliced end of the rope, measure 1/2 fid plus a fid short section. Use these marks to do a Back Splice as follows:

3A Insert the end of the rope in at the 1/2 fid mark and out at the short section mark.

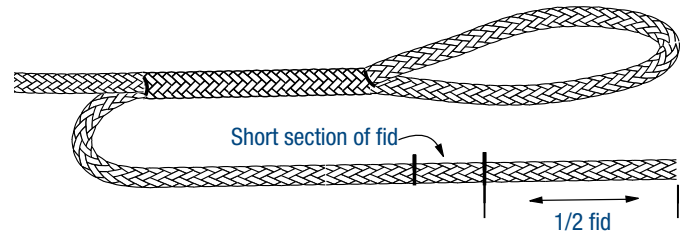

3B Pull firmly on the tail until the "eye" completely closes.

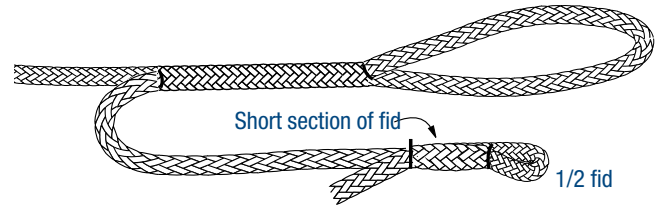

3C Grasp the "butt" of the splice and milk back towards exit point.

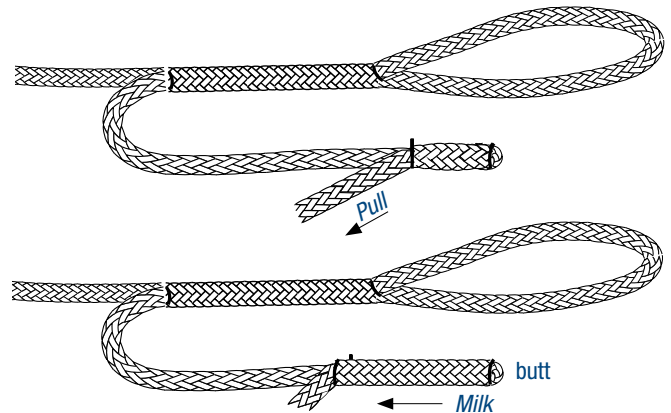

3D Mark the tail at the exit point. Pull the tail out slightly and cut off at an angle.

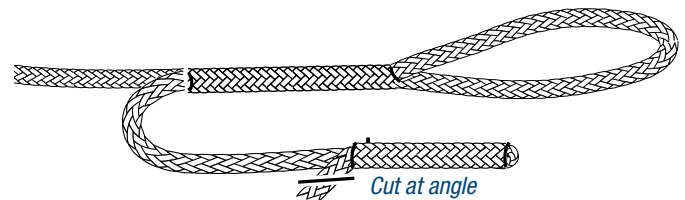

3E Re-milk to bury tail.



Completed Whoopie Sling



16-Strand Class I Eye Splice

Class I 16-strand ropes are made from any or all of the following fibers: olefin, polyester, or nylon.

The eye splice is used to place a permanent loop in the end of a rope, generally for attachment purposes to a fixed point. An eye is also used to form the rope around a thimble, which is used to protect the rope, especially when it is to be attached to a shackle, chain, or wire rope.

TIP: For this rope a wire fid is easier to use than a tubular fid. Also, leave as little tape as possible on the end of the rope. This will help on Step 4A when you begin the taper.

STEP 1 MEASURING AND MARKING

1A Measure 28 inches from end of rope and make Mark A.

1B Form desired size of eye and make Mark B opposite Mark A.

1C Measure 22 inches down from Mark B and make Mark C.

1D Measure 11 inches down from Mark C and make Mark D.

1E Tie a knot in body of the rope about 20 inches down from Mark D.

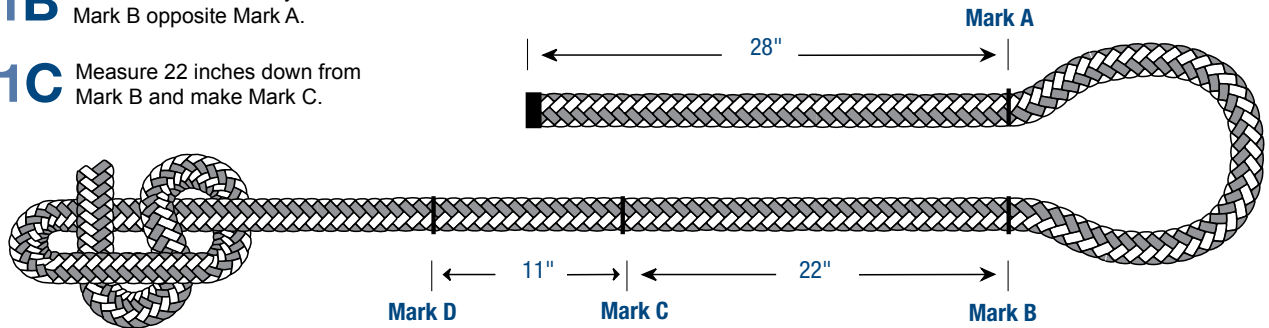

STEP 2 MARKING COVER TAPER

2A From Mark A count 5 strand pairs toward the end of rope and mark the 5th pair (left and right strands.)

2B Continue counting down 5 pairs and marking the 5th pair until a total of 5 strand pairs are marked.

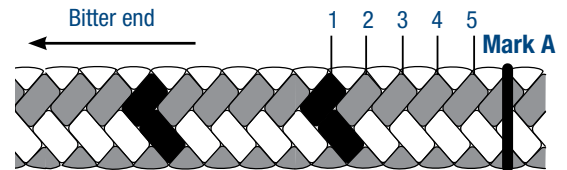

STEP 3 REMOVING THE CORE

Carefully open up the braid at Mark C and pull out the core yarns from the end of the rope back to Mark C.

TIP: Cut the core yarns in half. This makes the yarns easier to work with.

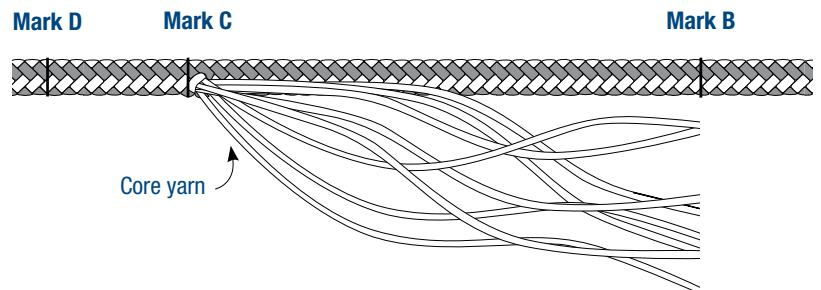

STEP 4 TAPERING END OF ROPE

4A Pull out marked strand pairs from cover braid. Do not cut.

4B Tape end of cover tail and attach thin wire fid to tapered end of rope with a thin layer of tape.

TIP: Once 2-3" are pulled out, wrap extra around a stationary point to help pull the rest of the line out. Then, lay all of the strand pairs out to confirm there are 5 pairs. Cut the excess material down to about 8". This will allow easier handling.

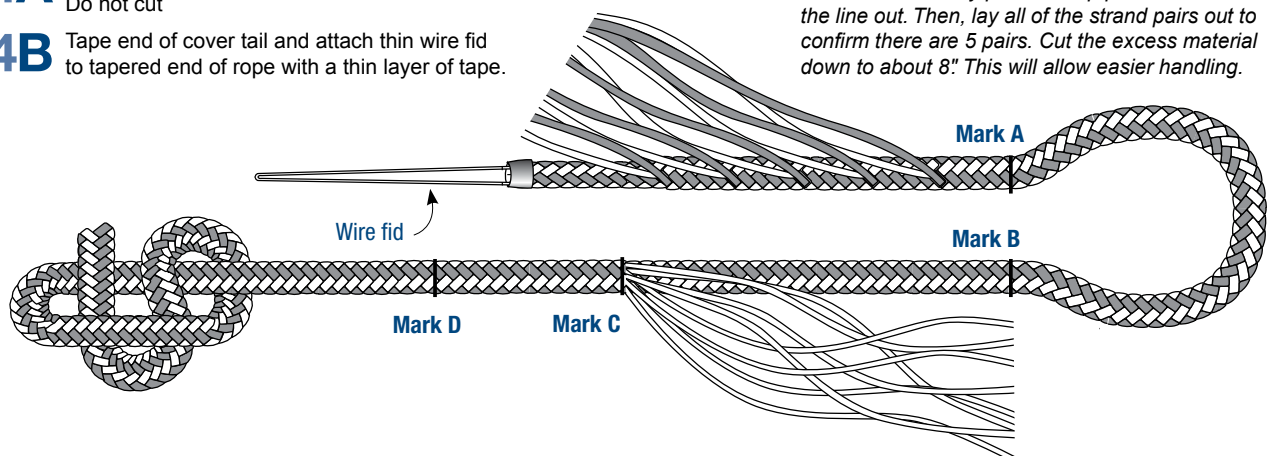

16-Strand Class I Eye Splice

STEP 5 PERFORMING SPLICE

- 5A** Insert fid into rope at Mark B and out at Mark D.
- 5B** Pull tail through body of rope from B to D.
- 5C** As each marked strand pair is about to be buried in the rope at Mark B, carefully cut each strand in the marked pair.
- 5D** Continue to pull the tail end of the rope through until Mark A and Mark B coincide.

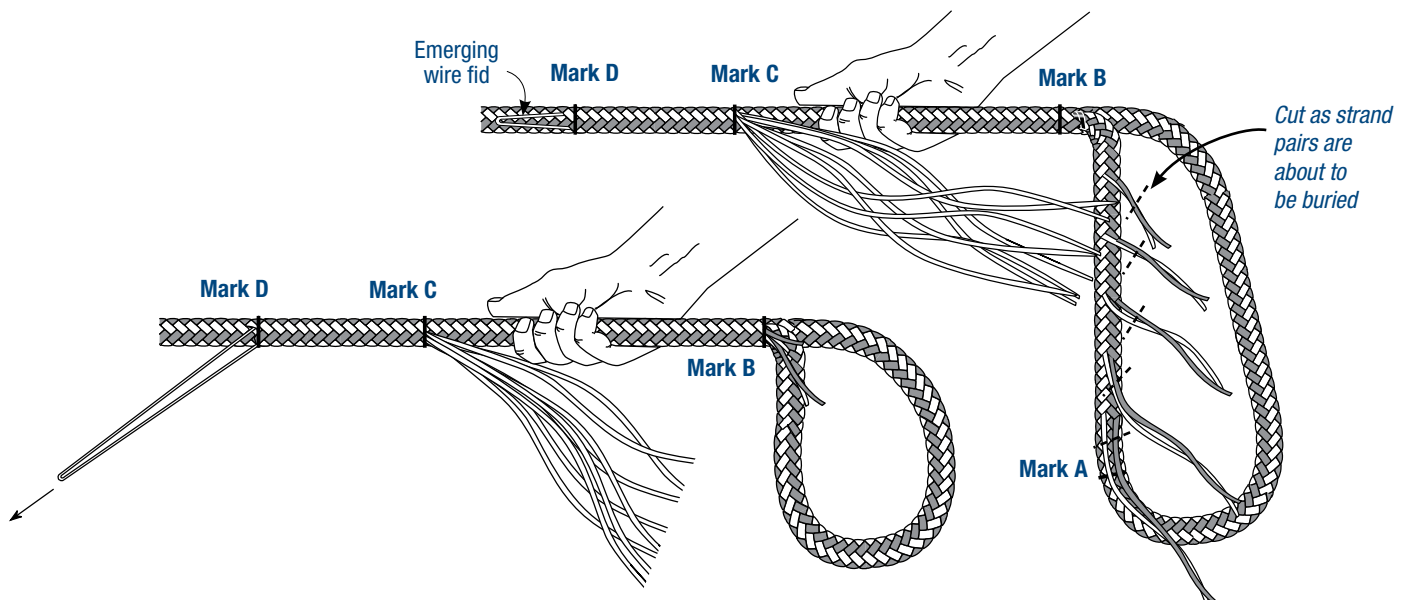

STEP 6 MARKING TAILS

- 6A** Smooth rope from eye at Mark B, back to Mark D to remove all slack in the braid.
- 6B** Smooth rope from knot to Mark C to bury as much of the core yarns as possible.
- 6C** Mark both cover tail and core yarns where they exit from the body of the rope.

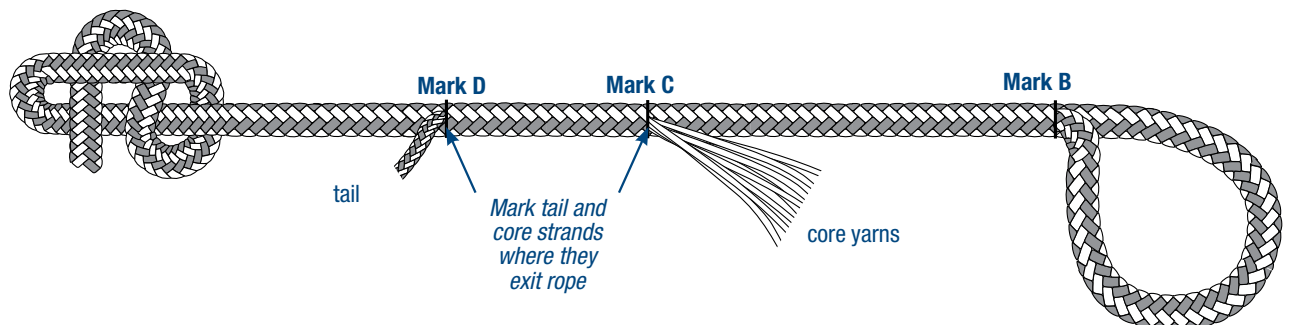

16-Strand Class I Eye Splice

STEP 7 FINAL TAPER

7A Pull buried core tails and cover yarns out of rope at their respective exit points until about 13 inches are exposed. This is the distance that the tail and core yarns overlap in the splice.

7B Cut both cover tail and core yarns where they were marked in Step 6C.

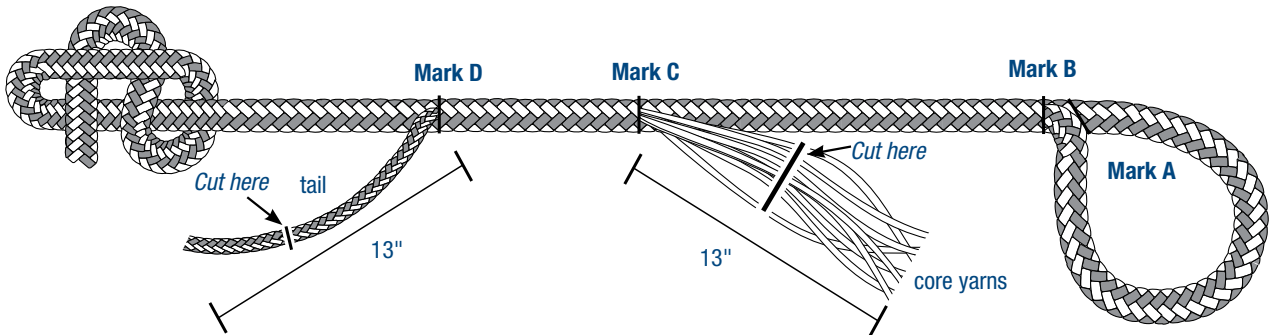

7C Measure from the cut ends back 6-1/2 inches towards the point where they exit from the rope (both the cover and core tails.) Taper the tails by cutting out 1 S-twist and 1 Z-twist strand approximately every 1-1/2 inches. This taper provides a smooth transition from the buried tail of the splice to the core yarns extending down the remainder of the rope.

7D Bury the exposed ends by alternately smoothing the rope from the eye down and from the knot up.

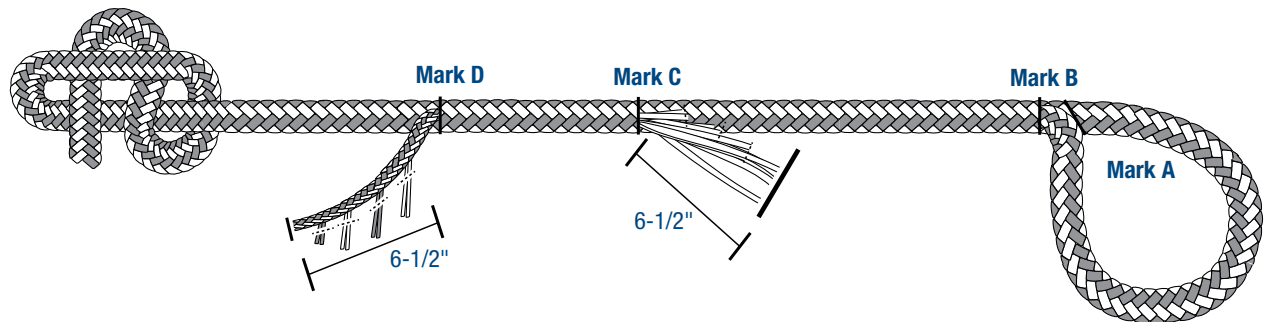

STEP 8 FINISHING THE SPLICE

8A Secure knot firmly in place and pull sharply on eye to make sure all slack is removed from splice area and that the cover and core tails are seated properly.

8B Optional: Apply whipping to base of eye for a distance of about 1 inch or 2 rope diameters.

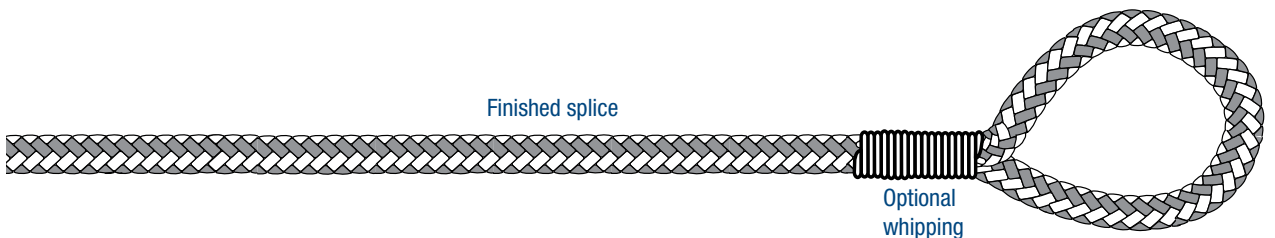



Double Braid Class I Back Splice

Class I Double Braids are made from any or all of the following fibers: olefin, polyester, or nylon.

The Samson Back Splice is a neat and permanent way to terminate the end of a line. It is flexible and can be tapered to reduce bulk. To make a Back Splice half as long as described, use half measurements.



Finished splice

STEP 1 MEASURING AND MARKING

Tape end to be spliced with 1 thin layer of tape. Then, measure 1 tubular fid length from end of rope and mark. This is Point X (Extraction).

Tie a tight slipknot approximately 5 fid lengths from Point X. This must be done.

Core must be extracted from cover here at **Point X**

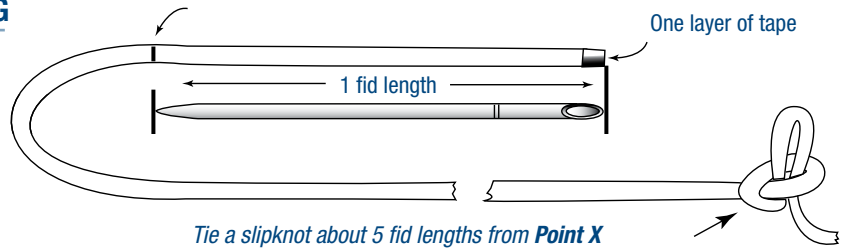

STEP 2 EXTRACTING THE CORE

Bend rope sharply at Point X. With pusher or any sharp tool such as an ice pick, awl, or marlin spike, separate cover strands to expose core. First pry, then, pull core completely out of cover from Point X to the taped end. Put 1 layer only of tape on end of core.

To assure correct positioning of Mark 1 do the following. Holding exposed core, slide the cover as far back towards the tightly tied slip knot as you can. Then, firmly smooth cover back from slip knot towards the taped end. Smooth again until all cover slack is removed. Then, mark core where it comes out of the cover. This is Mark 1.

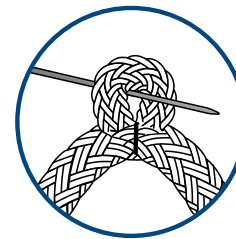

Prying out the core

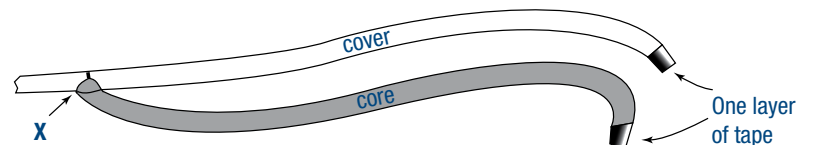

STEP 3 MARKING THE CORE

Again, slide cover toward the slipknot to expose more core.

From Mark 1 measure along core towards Point X a distance equal to the short section of fid and make 2 heavy marks. This is Mark 2.

From Mark 2 measure in the same direction 1 fid length plus another short section and make 3 heavy marks. This is Mark 3.

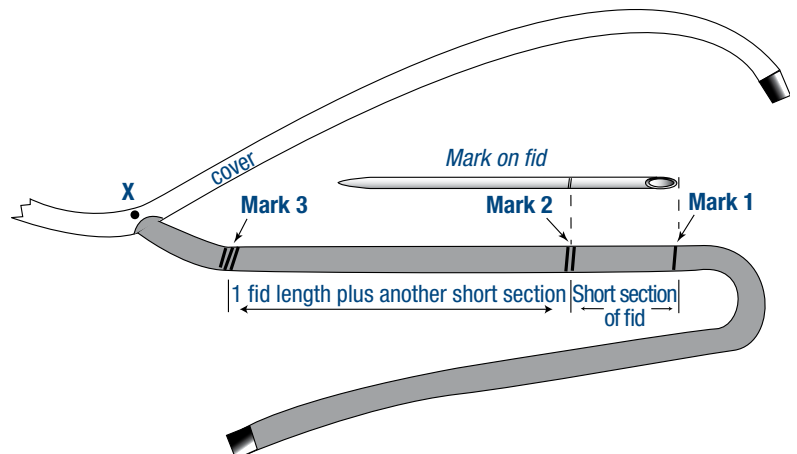



STEP 4 PUTTING THE COVER INSIDE CORE

Insert fid into core at Mark 2. Slide fid through and out at Mark 3.

Pinch taped end of cover, jam it tightly into hollow end of fid. Hold core lightly at Mark 3, place the pusher point into the taped end, and push fid and cover through from Mark 2 and out at Mark 3. When using wire fids for larger size ropes, attach fid to taped cover.

After fid is attached, milk the braid over the fid while pulling fid through from Mark 2 to Mark 3.

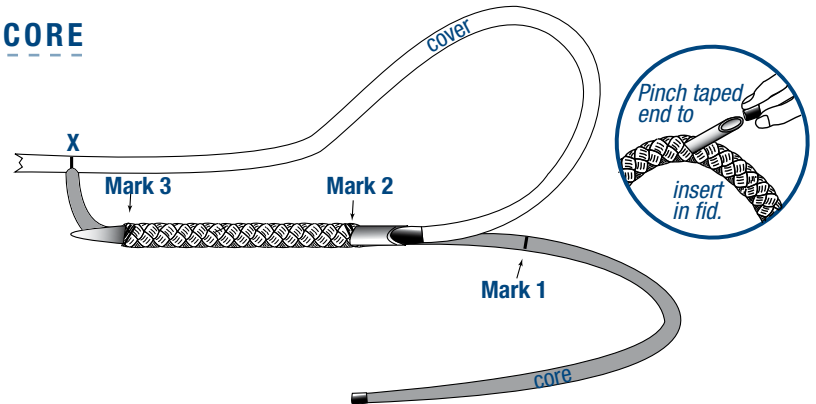

STEP 5 ADJUSTING THE CORE OVER COVER

Remove tape from cover end. Cut cover strands at an angle to avoid blunt end.

Smooth core from Mark 2 toward Mark 3 until cover ends just disappear inside.

Next, holding core at Mark 3, smooth core from Mark 3 to Mark 2. Do this until all excess is eliminated.

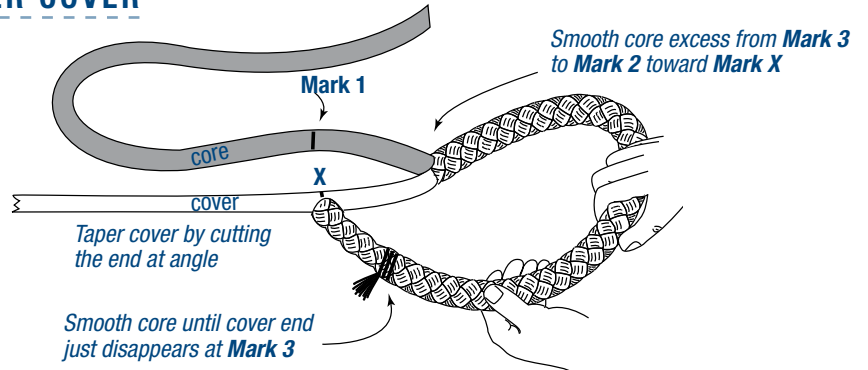

STEP 6 BURYING THE EXPOSED CORE

Hold rope at slipknot and with other hand, milk the cover toward splice, gently at first, and then more firmly. The cover will slide over Mark 3, Mark 2, and finally Point X.

Be sure all excess cover is milked out so that Point X (which will show as a bump) is well inside the cover.

If final burying is difficult, flex the splice back and forth to loosen the strands, then continue burying.

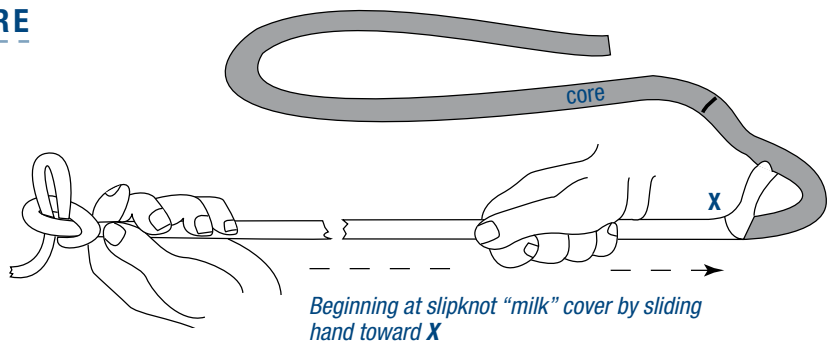

STEP 7 FINISHED SPLICE

Cut the protruding core off close at the cover. Once again milk cover firmly towards the end so that it covers the cut off core.



Finished Back Splice



Double Braid Class I End-For-End Splice

Class I Double Braids are made from any or all of the following fibers: olefin, polyester, or nylon.

This splice can be performed on new and used rope. This is an all-purpose splice technique designed for people who generally splice used rope as frequently as new rope.

Finished splice



STEP 1 MEASURING AND MARKING

Tape the end of each rope with 1 thin layer of tape. Lay 2 ropes to be spliced side-by-side and measure 1 tubular fid length from end of each rope and make a mark. This is Point R (Reference).

From Point R measure 1 short fid section length (as scribed on the fid) then mark. This is Point X (where you should extract core from inside cover.) Be sure both ropes are identically marked. Tie a slipknot approximately 5 fid lengths from Point X.

Note: If you require the rope with the finished splice to be a certain overall length, refer to "Double Braid Class I Special Tips for Splicing," on the last page of these splice instructions.

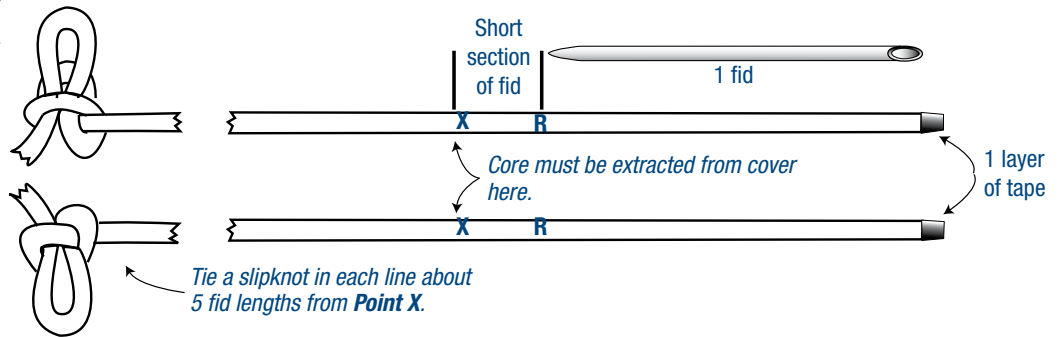

STEP 2 EXTRACTING THE CORE

Bend rope sharply at Point X. With a pusher or any sharp tool, such as an ice pick, awl, or marlin spike, spread cover strands to expose core. First pry, then pull core completely out of cover (shown in white) from Point X to the end of rope. Put 1 layer only of tape on end of core (shown in gray).

To assure correct positioning of Mark 1 do the following: holding the exposed core, slide cover as far back towards the tightly tied slip knot as you can. Then, firmly smooth cover back from the slip knot towards taped end. Smooth again until all cover slack is removed. Then, mark core where it comes out of cover. This is Mark 1. Do this to both ropes. (Fig. A)

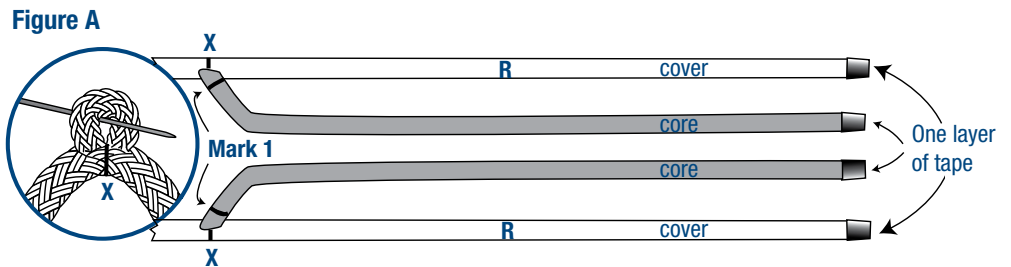

Do not pull cover strands away from rope as this will distort cover unnecessarily.

STEP 3 INSERTING CORE INTO CORE

Hold 1 core at Mark 1 and slide cover back to expose more core. (Fig. B)

3A From Mark 1, measure along core towards X a distance equal to the short section of fid and make 2 heavy marks. This is Mark 2.

3B From Mark 2 measure in the same direction 1 fid length plus another short section and make 3 heavy marks. This is Mark 3.

Mark second core by laying it alongside the first and using it as an exact guide.

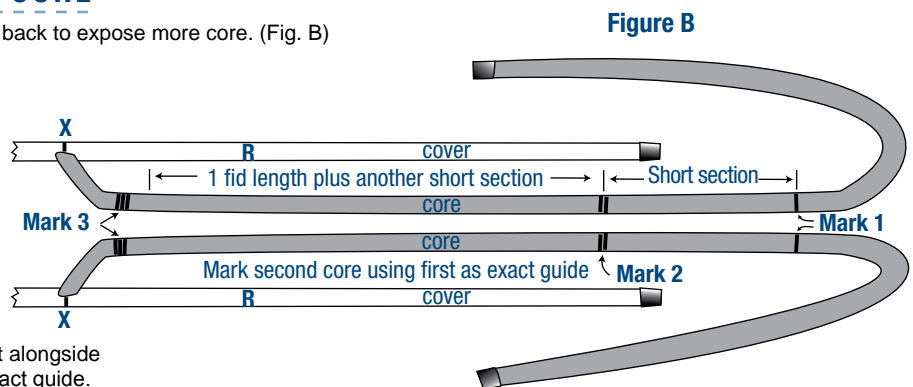



Double Braid Class I End-For-End Splice

STEP 4 MARKING THE COVER FOR TAPERING

Note nature of the cover braid. It is made up of strands. By inspection you can see that half the strands revolve to the right around the rope and half revolve to the left.

Beginning at Point R and working toward the taped end of cover, count 8 consecutive pairs of cover strands that revolve to the right (or left). Mark the 8th pair. This is Point T, which should go completely around cover.

Starting at Point T and working toward the cover's taped end, count and mark every second right and left pair of strands for a total of 6. Then, on the other rope starting at Point T, count and mark every second right and left pair of strands for a total of 6. Make both ropes identical.

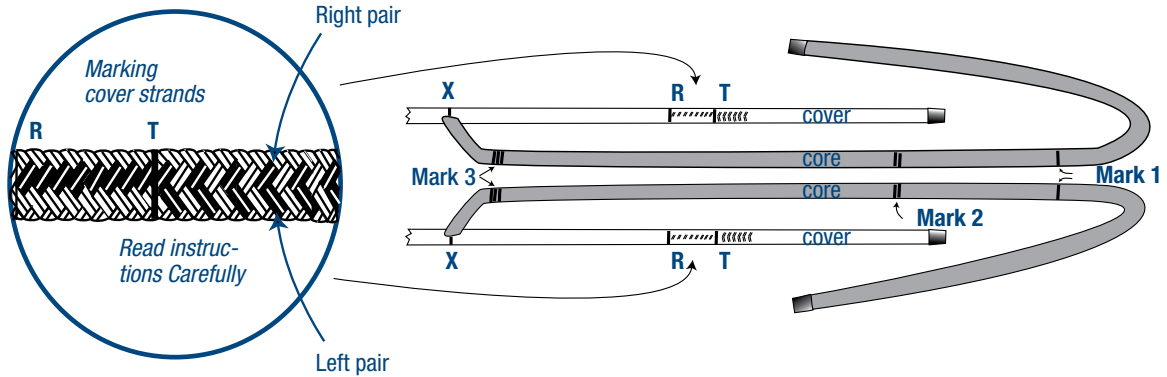

STEP 5 PERFORMING THE TAPER

On the first rope, remove tape from cover end. Starting with last marked pair of cover strands toward the end, cut and pull them completely out. Cut and remove next marked strands and continue with each right and left marked strands until you reach Point T. Do not cut beyond this point. Retape tapered end.

On the second rope cut and remove marked strands on the other marked cover, again stopping at Point T. Retape tapered end (Fig. C).

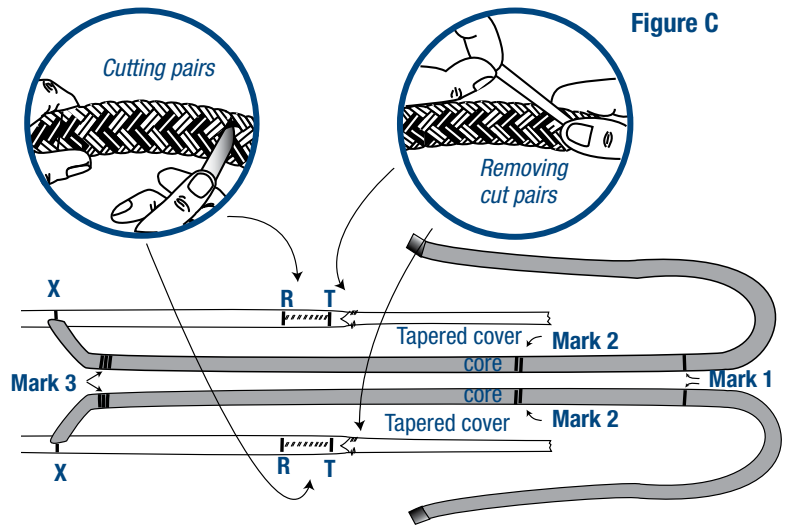

STEP 6 REPOSITIONING THE ROPES

Reposition ropes for splicing according to Fig. D. Note how the cover of one rope has been paired off with core of the opposite line. Avoid twisting.

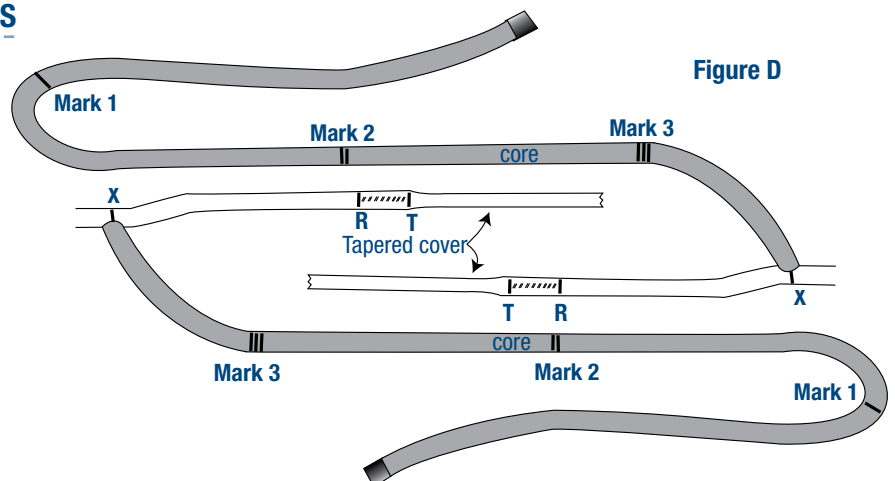



Double Braid Class I End-For-End Splice

STEP 7 PUTTING THE COVER INSIDE CORE

Insert fid into first core (shown in gray) at Mark 2 and bring it out at Mark 3. Add extra tape to tapered cover (shown in white) end then jam it tightly into hollow end of fid. Hold core lightly at Mark 3, place pusher point into taped end pushing fid and cover in it from Mark 2 and out at Mark 3. (When using wire fid, attach fid to cover.) Then pull fid through from Mark 2 to Mark 3. Pull cover tail through core until Point T on cover meets Mark 2 on core. Insert other cover into core in same manner (Fig. E).

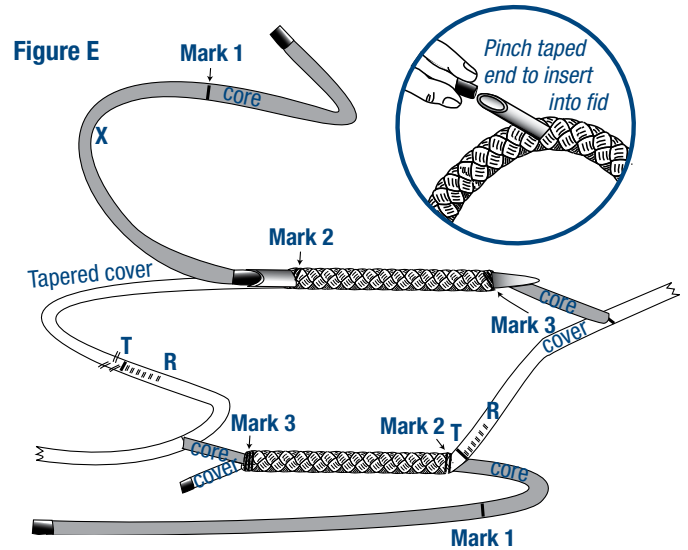

STEP 8 REINSERTING THE CORE INTO THE COVER

Now put core back into cover from Point T to Point X. Insert fid at Point T, jam tapered core tightly into end of fid (Fig. F). With pusher, push fid and core through cover bringing out at Point X. When using wire fid attach fid to tapered core. Then pull fid and braid through from Point T to Point X. Do this to both cores. Remove tape from end of cover. Bring crossover up tight by pulling on core tail and tapered covered tail. Hold crossover tightly, smoothing out all excess braid away from crossover in each direction. Trim end of tapered cover at an angle to eliminate blunt end. Tapered cover tail will disappear into core at Mark 3. Cut core tail off close to Point X at an angle.

Figure F

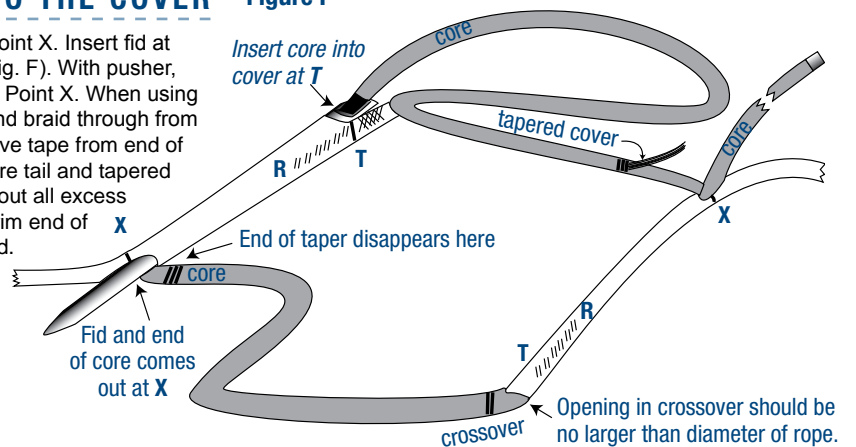

STEP 9 BURYING THE EXPOSED CORE

Hold rope at slipknot and with other hand milk cover toward the splice, gently at first, and then more firmly. The cover will slide over Mark 3, Mark 2 the crossover and Point R. Repeat on the other side of the splice. Continue burying until all cover slack between the knot and the splice has been removed.

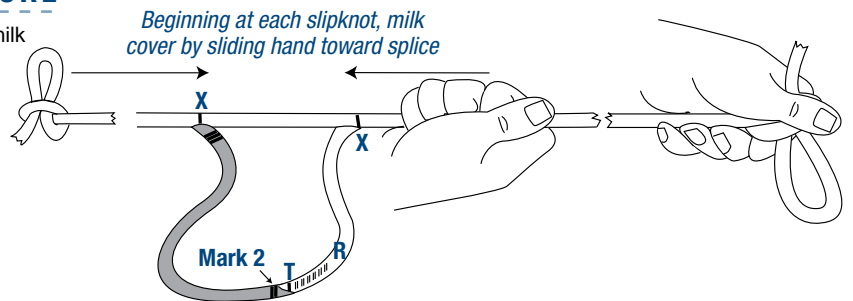

STEP 10 FINISHING THE SPLICE

The splice is finished when all cover slack has been removed and there is an opening in the splice approximately equal in length to the diameter of rope. If, at the opening, one side of the splice is noticeably longer than the other side, something is wrong. Check Steps 1-9 and remake if necessary.

Now untie the slip knots.

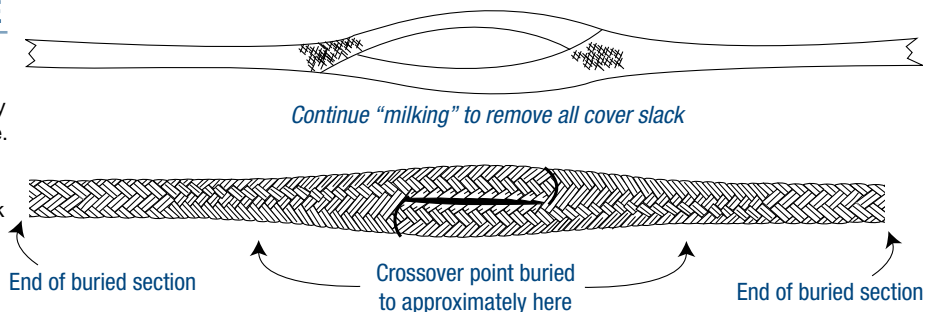



Special Tips for Splicing Double Braid Class I

SPLICE WITH THIMBLE

Follow Step 1 of the Eye Splice Double Braid Class I for determining the correct eye size. When burying exposed core, as in Step 8, bury to crossover, then insert thimble into eye before milking cover all the way. If using a thimble with ears, before inserting cover into core, as in Step 5, insert core through the rings (dog ears) and slide thimble beyond Mark 3. Proceed to make the splice according to instructions.

Note: Before final burying, slide thimble around to cover side of eye. To secure finished eye tightly around thimble, either whip throat or dip the eye in hot water for several minutes. Hot water will shrink the eye tightly around thimble for nylon and polyester fiber ropes.

SPLICING ROPES 3" DIAMETER OR LARGER

Before splicing rope, measure back 8 fids and insert a large fid through the rope to anchor the core and cover together. Use a milking strap to milk slack of cover toward end of rope. A milking strap is a smaller diameter rope that is cinched around the rope to create more seizing power than a human hand can apply. It helps to pull the milking strap with mechanical means (a winch or come-along.) Cut off any excess cover.

Milking the cover is a crucial step and will be done several times during this splice. The milking process aligns the core and cover braid angles and allows them to more effectively share the load when the rope is in use. It is best done with a milking strap for ropes 3" diameter or larger

After milking, check for cover slack. If cover slack remains, repeat milking process until slack is gone.

MINIMUM LENGTHS

Minimum eye-and-eye sling length with Class I Double Braid is 5 fid lengths from extraction Mark X to extraction Mark X, regardless of rope diameter. The size of eye does not affect the minimum length. Proceed to make the eye splice as per instructions.



Example: How to make an Eye-and-Eye Sling 10' long overall with two 6" eyes:



Measure and cut a length:

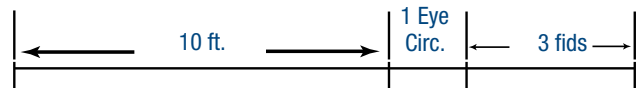

Then start with Step 1 of Class 1 Double Braid splice.

END-FOR-END SPLICE

Minimum endless loop (Grommet) with Class I Double Braid is 10 fid lengths between extraction Mark X to extraction Mark X, regardless of rope diameter. Proceed with the Class I Double Braid End-for-End splicing instructions.

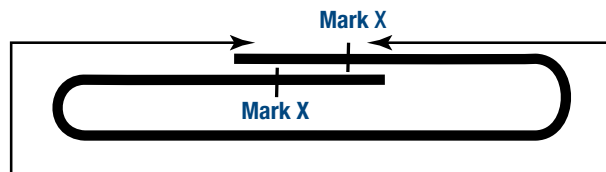

Exact overall lengths with endless loops are determined by allowing for extra rope consumed in making the End-for-End Splice. The length of extra rope is equal to 4 fid lengths.

Example: To make an endless loop 10' overall:

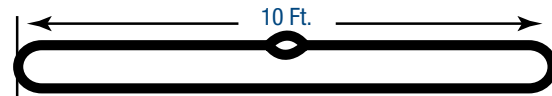

Measure and cut a length:



Then start with Step 1 of the End-for-End Double Braid Class I Splice instruction.



Double Braid Class I Eye Splice Modified for Used Rope

samson
THE STRONGEST NAME IN ROPE

Class I ropes are made from any or all of the following fibers: olefin, polyester, or nylon.

This is an eye splice which can be performed on used rope. This is an all-purpose splice technique designed for people who generally splice used rope as frequently as new rope.

You may wish to read the supplemental information, "Special Tips for Splicing Used Rope" at the end of these instructions, before beginning.

Splicing used rope can be made easier by first understanding the rope condition. Natural shrinkage has occurred caused by water and heat. In addition, the cover yarns have often been abraded. Soak the section of rope to be spliced in water for several minutes — this lubricates and loosens fibers.

STEP 1 MEASURING AND MARKING

Tape end to be spliced with 1 thin layer of tape. Then, measure 1 tubular fid length from end of rope and mark. This is Point R (Reference). From Point R form a loop the size of the eye desired and mark. This is Point X, where you extract core from inside the cover. If using a thimble, form the loop around the thimble.

Tie a tight slipknot approximately 5 fid lengths from Point X. This must be done!

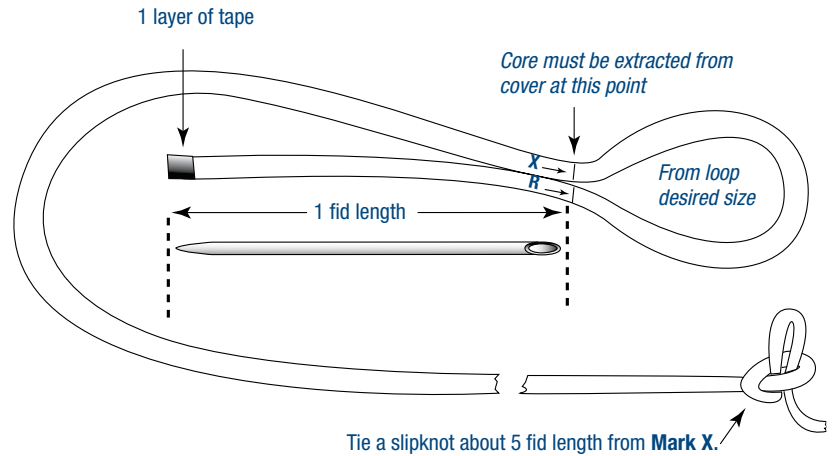

STEP 2 EXTRACTING THE CORE

Bend rope sharply at Point X. With the pusher or any sharp tool such as an ice pick, awl, or marlin spike, spread the cover strands to expose core. First pry, then, pull the core completely out of cover from Point X to the taped end of the rope. Put one layer only on end of core.

Tip: After marking cover, untape end of rope, grasp end of core, and slide back cover pulling out core. This loosens and bunches up cover strands in the area of Point X and makes it easier to open up cover strands for extraction. Also, thoroughly loosen 3–4 strand pairs at Point X to assure a large and flexible hole for extraction, see right.

To assure correct positioning of Mark 1 do the following:

Holding the exposed core, slide cover as far back towards the tightly tied slipknot as you can. Then, firmly smooth the cover back from the slipknot towards taped end. Smooth again until all cover slack is removed. Then, mark the core where it comes out of the cover. This is Mark 1.

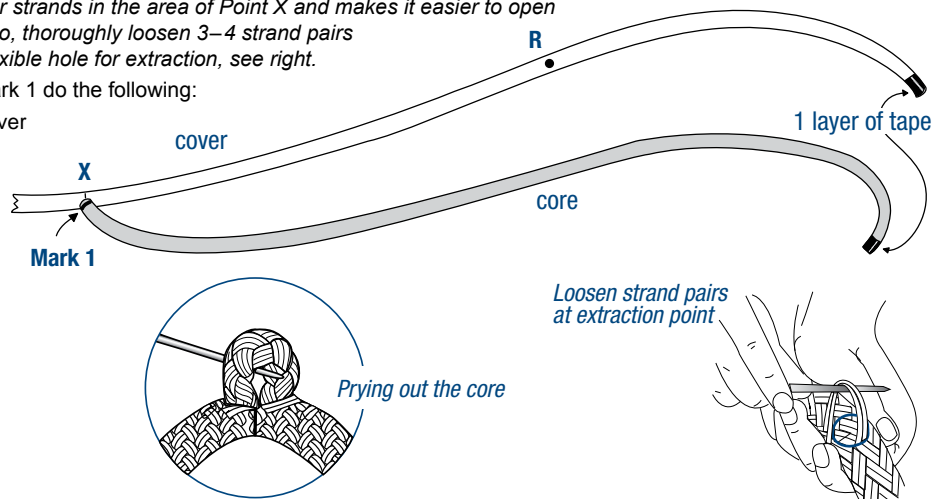

STEP 3 MARKING THE CORE

Again slide cover toward slipknot to expose more core.

From Mark 1, measure along core towards Point X a distance equal to the short section of tubular fid and make 2 heavy marks. This is Mark 2.

From Mark 2, measure in the same direction 1 fid length plus another short section of the fid, make 3 heavy marks. This is Mark 3.

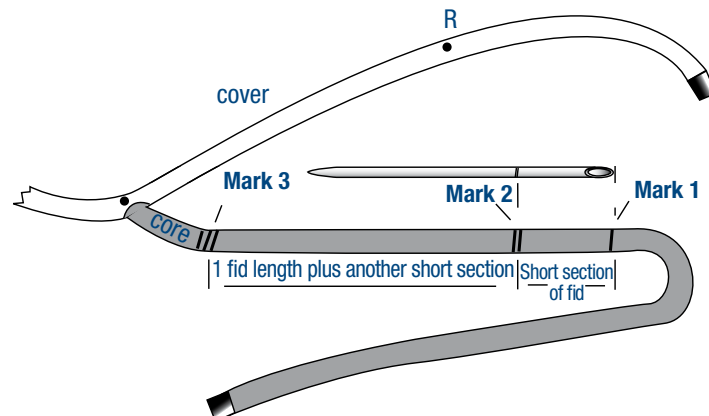



Double Braid Class I Eye Splice Modified for Used Rope

samson
THE STRONGEST NAME IN ROPE

STEP 4 MARKING THE COVER FOR TAPERING

Note nature of cover braid. It is made up of strands – single or paired. By inspection you can see half the strands revolve to the right around rope and half revolve to the left.

Beginning at Point R and working toward taped end of the cover, count 8 consecutive strands (1 or 2) which revolve to the right (or left). Mark the 8th strand. This is Mark T. Make Mark T go completely around cover.

Starting at Mark T and working toward the taped cover end, count and mark every 2nd right set of strands for a total of 6. Again starting at Mark T, count and mark every 2nd left set of strands for a total of 6.

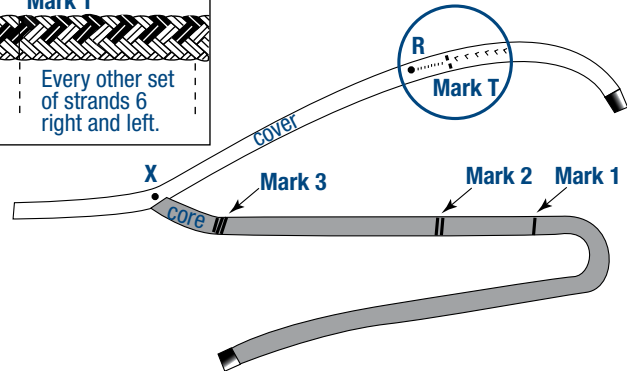
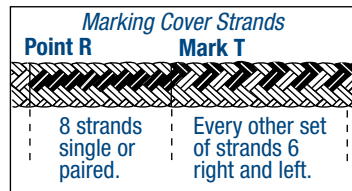

STEP 5 PERFORMING THE TAPER

First remove tape from cover end. Start with last marked set of cover strands toward the end, cut and pull them completely out. Cut and remove next marked strands and continue with each right and left marked strands until you reach Mark T. Do not cut beyond this point.

The end of the cover has now been tapered from Mark T to the end. Retape tapered end.

Note: If the same strand(s) is marked twice by accident, continue as though it is another strand.

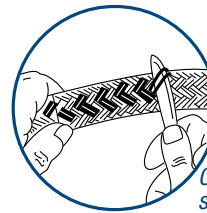
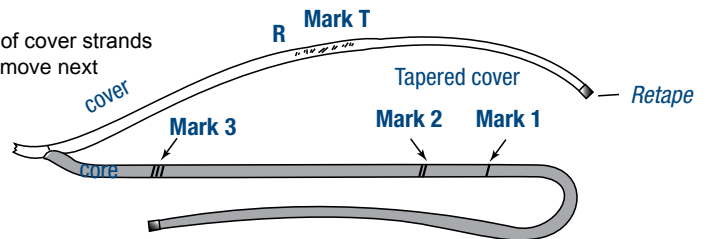

Cutting strands

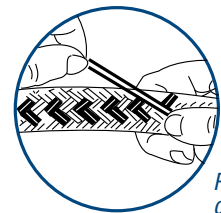

Removing cut strands

STEP 6 PUTTING THE COVER INSIDE THE CORE

Insert fid into core at Mark 2. Slide it through and out at Mark 3.

Add extra tape to tapered cover end; then jam it tightly into the hollow end of fid. Hold core lightly at Mark 3, place pusher point into taped end, and push fid and cover through from Mark 2 and out at Mark 3.

With wire fid first press prongs into cover, then tape over. Insert fid and milk braid over fid while pulling fid through Mark 2 to Mark 3.

Take the fid off the cover. Continue pulling cover tail through the core until Mark T on the cover meets Mark 2. Then remove tape from end of tapered cover.

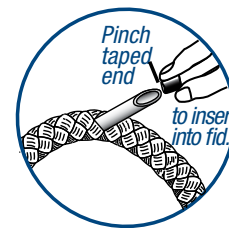

Pinch tapered end to insert into fid.

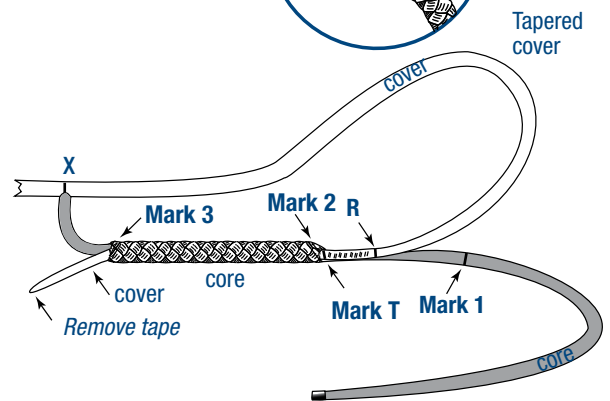
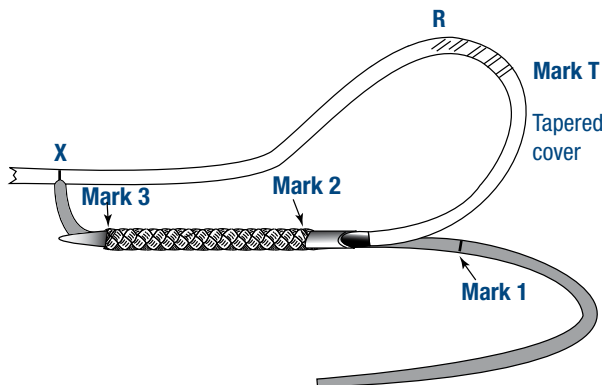



Double Braid Class I Eye Splice Modified for Used Rope

samson
THE STRONGEST NAME IN ROPE

STEP 7 REINSERTING CORE INTO COVER

You are now ready to put core back into cover from Mark T to Point X. Insert fid at Mark T, jam the taped core end tightly into end of fid. With pusher, push fid and core around to, and through opening at Point X (exactly where core was first extracted.) When using wire fid, attach fid to taped core. After fid is on, milk braid over fid while pulling through from Mark T to Point X.

Depending on eye size, fid may not be long enough to reach from Mark T to Point X in one pass. If not, bring fid out through cover, pull core through and reinsert fid into exact hole it came out of. Do this as many times as needed to reach Point X.

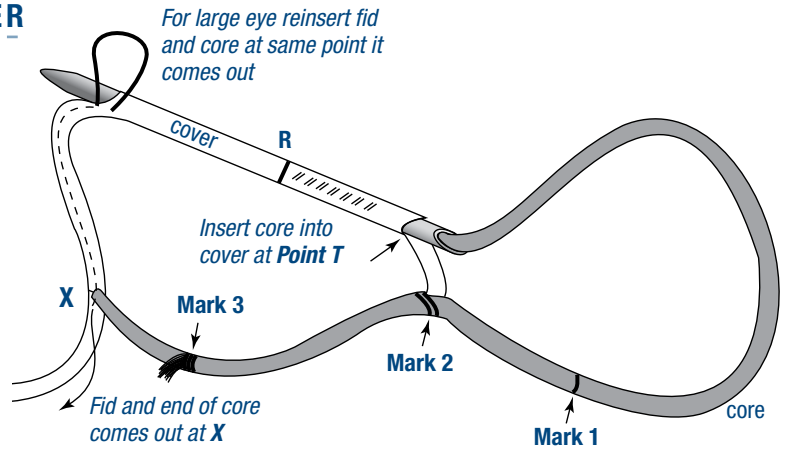

STEP 8 PREPARING TO BURY CORE

Next, pull on core tail coming out at Point X, then on tapered cover coming out at Mark 3, the crossover should be tightened until opening in crossover is approximately equal to diameter of rope. Hold the loop at the crossover with one hand. With other hand firmly smooth towards Point X in one direction, and towards Mark 3 in other direction. Remove all cover slack. Tapered cover will disappear at Mark 3. Then cut core tail off close where it comes out at Point X.

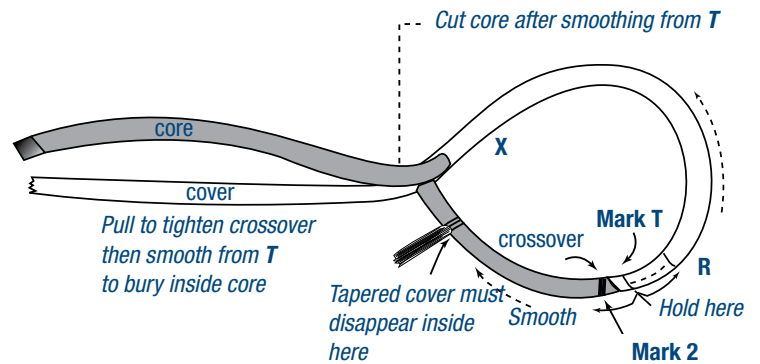

STEP 9 BURYING THE EXPOSED CORE

Hold rope at slipknot and with other hand milk cover toward splice, gently at first, then more firmly. Cover will slide over Mark 3, Mark 2, the crossover, and Point R.

Then smooth loop from Mark T to Point X removing all slack. Continue milking until all cover slack between knot and throat of eye has been removed.

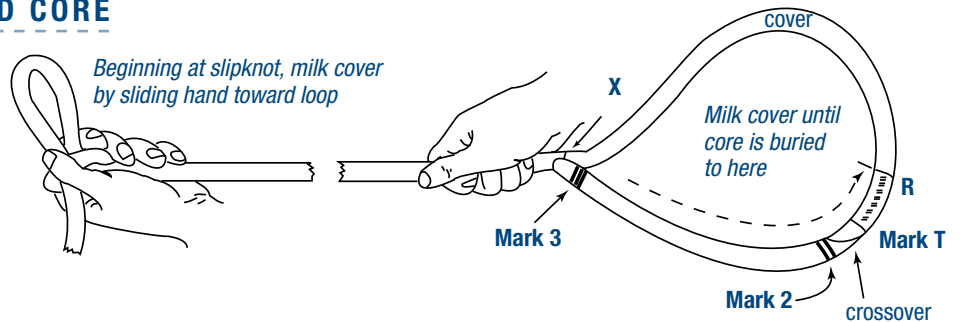

STEP 10 FINISHING THE SPLICE

Now untie the slipknot. If eye is not the right size, carefully check Steps 1 through 9.

If a hollow spot appears at the throat this means that the core tail was cut too short. Do not worry as this does not affect the splice performance nor its strength. Reason: the total load of an eye splice is split between the two legs. Therefore, each side of the splice only has to support 50% of the total load. The braided cover alone can handle this load factor.

You should whip the eye splice starting at base of throat of eye, especially if rope is 1" diameter and larger.

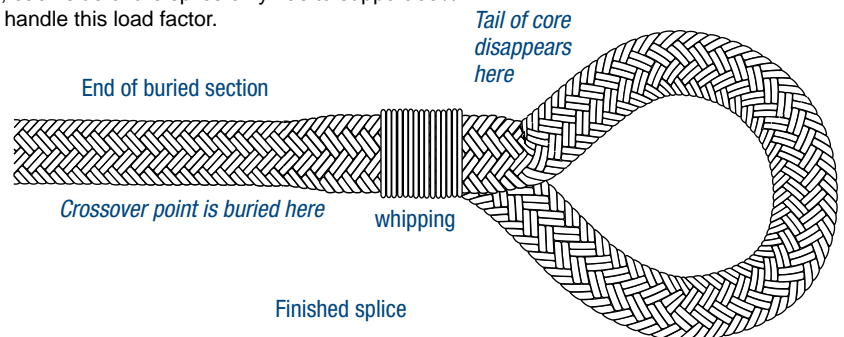



Special Tips: Splicing Used Double Braid

Splicing used rope can be made easier by first establishing the rope's condition. Natural shrinkage may have occurred, caused by water and heat. Sometimes the cover yarns have been braided. By using the technique outlined in the Used Rope Eye Splice for Class I Double Braids, along with the following tips, you can splice used braided rope more easily and with better results.

TIP 1

Before you begin, soak the section of rope to be spliced in water for several minutes — this lubricates and loosens fibers.

TIP 2

After marking cover (as shown in Step 2 of the splicing instruction) untape end of rope, grasp end of core, and slide back cover to pull out core. This loosens and bunches up cover strands in the area of Point X making it easier to open up cover strands for extraction. Carefully loosen 3–4 strand pairs at Point X to assure a large and flexible hole for extraction (Fig. A).

Figure A

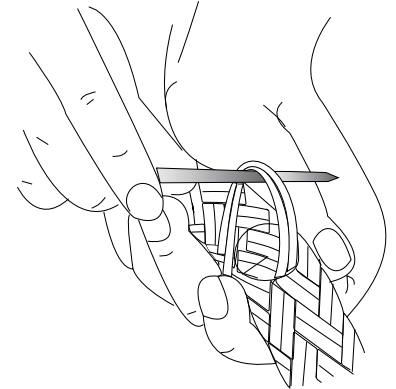

TIP 3

The use of a shock cord in a rolling hitch around the cover is useful to make final burying easier and more complete. Pull on the hitch toward the eye until all cover slack is removed (Fig. B).

Figure B

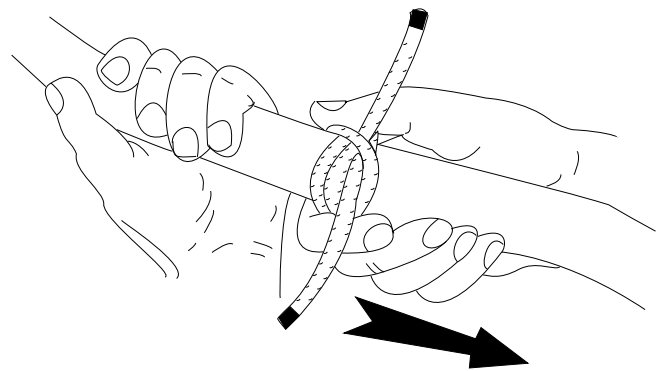

Whipping Method I and Seizing Method II

Choosing twines for whipping:

In general, braided nylon twine is preferred for whipping. Polyester twines, or twisted twines in either polyester or nylon, can also be used.

For double braids the twine used should be approximately twice the diameter of the strands in the cover.

Whip or seize the end of the spliced area with whipping twine for extra security and a professional touch. Keeping tension on rope while wrapping results in tighter whipping.

STEP 1 Form loop along the rope with whipping twine and wrap end around the back.

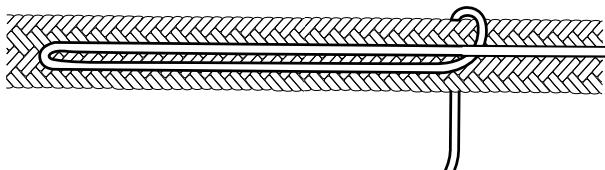

STEP 2 Continue wrapping at least 1 rope diameter in length.

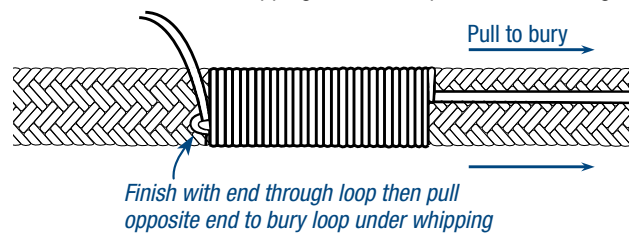

STEP 3 Cut both ends close to whipping.

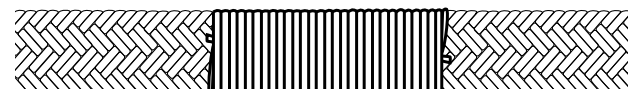



Double Braid Class I Eye Splice

Class I ropes are made from any or all of the following fibers: olefin, polyester, or nylon.

Note: This splice is not suitable for core-dependent double braid constructions (Double Braid Class II). For double braid Class I products over 2" in diameter, contact Samson for specialty splice instructions.

The eye splice is used to place a permanent loop in the end of a rope, generally for attachment purposes to a fixed point. An eye is also used to form the rope around a thimble, which is used to protect the rope, especially when it is to be attached to a shackle, chain or wire rope.

STEP 1 MEASURING AND MARKING

Tape end to be spliced with 1 thin layer of tape. Then measure 1 tubular fid length or 2 wire fid lengths from the end of the rope and mark. This is Point R (Reference). From Point R form a loop the size of the eye desired and mark. This is Mark X where you extract the core from inside the cover. If using a thimble, form the loop around the thimble. Tie a tight slipknot, or use a pin to keep the core and the cover secure approximately 5 fid lengths from Mark X. At this point it is easier to anchor the rope to a secure point just beyond the pin.

Note the nature of the cover braid. It is made up of strands with either 1, 2 or 3 ends. By inspection you can see half the strands revolve to the right around the rope and half revolve to the left. Beginning at Point R and working toward the taped end of the cover, count 8 consecutive strands (where one strand may consist of 1, 2, or 3 ends depending on the rope) which revolve to the right (or left). Mark the 8th and 9th strand. At the 8th strand, this is Mark T. Make Mark T go completely around the cover. Starting at Mark T and working toward the taped cover end, count and mark every 5th right and left strand until you reach the end of the cover. For ropes with 20 cover strands, mark every 5th and 4th right and left strand until you reach the end of the cover.

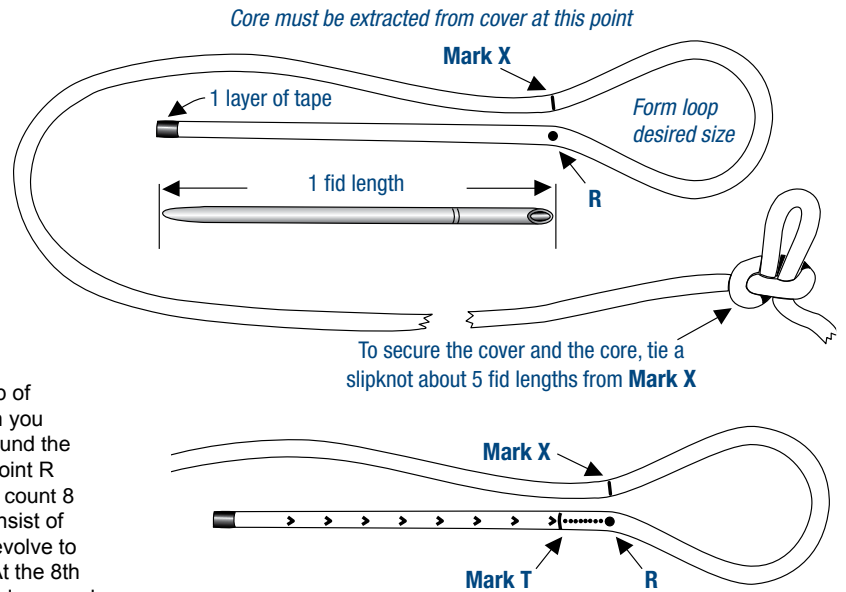

STEP 2 EXTRACTING THE CORE

Bend the rope sharply at Mark X. With a pusher or any sharp tool such as an ice pick, awl, or marlin spike, spread the cover strands to expose core. First pry, then pull the core completely out of the cover from Mark X to the taped end of the rope. Put 1 layer of tape on the end of the core.

Note: Do your best to avoid overstretching the cover strands.

To assure correct positioning of Mark 1 do the following:

Holding the exposed core, slide cover as far back as possible toward the tightly tied slipknot. Then, firmly smooth the cover back from the slipknot toward the taped end. Smooth again until all cover slack is removed. Then, mark the core where it comes out of the cover. This is Mark 1.

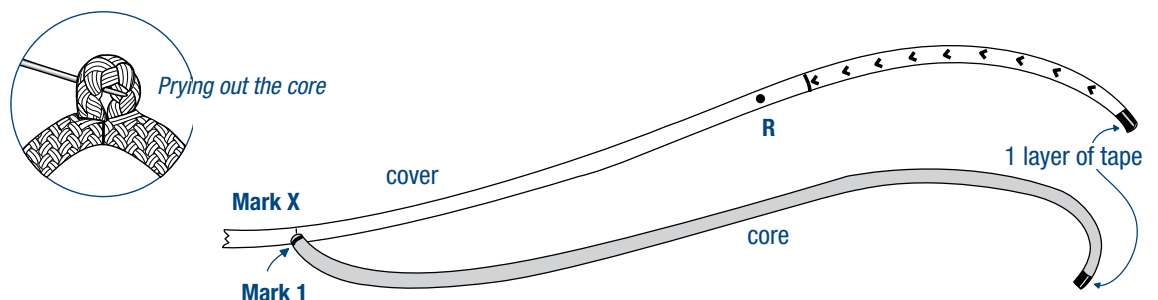



Double Braid Class I Eye Splice

STEP 3 MARKING THE CORE

Again, slide the cover toward the slipknot to expose more core. From Mark 1, measure along the core toward Mark X a distance equal to the short section of a tubular fid (2 short sections if using a wire fid) and make 2 heavy marks. This is Mark 2.

From Mark 2 measure in the same direction 1 fid length plus another short section of the fid (with a wire fid, double measurements) make 3 heavy marks. This is Mark 3.

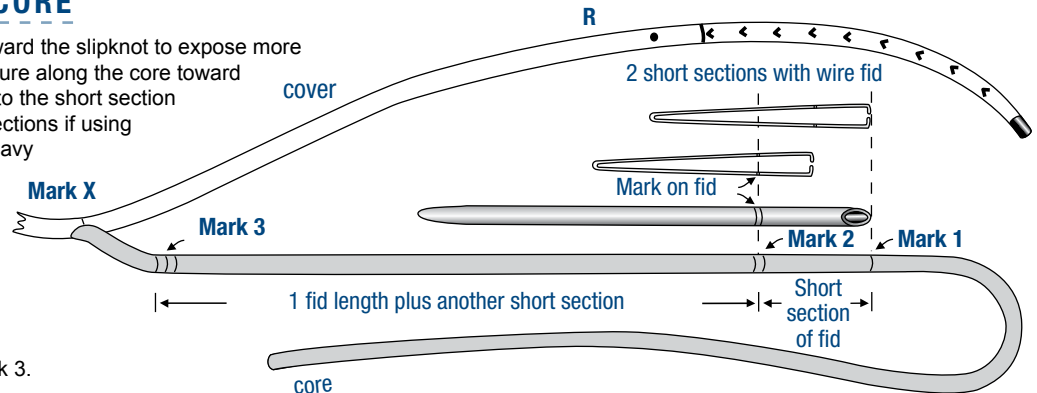

STEP 4 REINSERTING COVER INTO CORE

Insert the fid into the core at Mark 2. Slide it through and out at Mark 3. Add extra tape to the cover end then jam it tightly into the hollow end of the fid (see diagram). Hold core lightly at Mark 3, place pusher joint into taped end and push fid and cover through at Mark 2 and out at Mark 3. (With a wire fid, first press prongs into cover, then tape over. Then, after fid is on, milk braid over fid while pulling fid through from Mark 2 to Mark 3.)

Take the fid off the cover and continue pulling cover tail through the core until Point R on the cover emerges from Mark 3. Then remove the tape from the end of the cover.

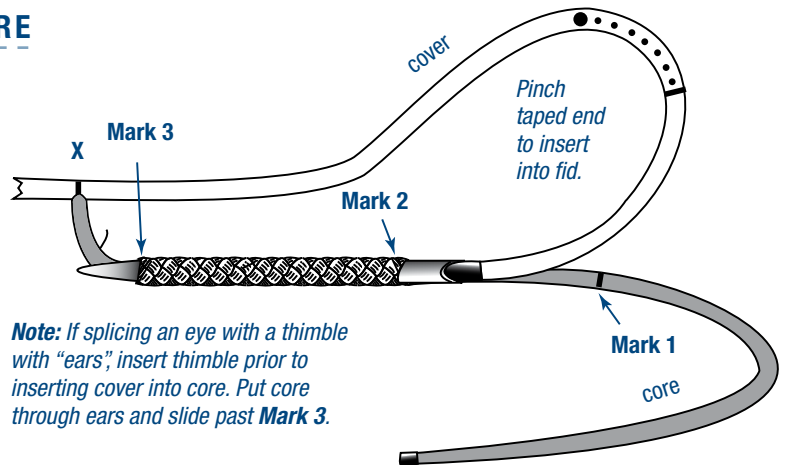

Note: If splicing an eye with a thimble with "ears", insert thimble prior to inserting cover into core. Put core through ears and slide past Mark 3.

STEP 5 PERFORMING TAPER

Start with the last marked pair of cover strands toward the end, pull one pair completely out (Fig. A). Cut and remove next marked strands and continue with each right and left marked strands until you reach Mark T. Do not cut beyond this point.

The result should be a gradual taper. Very carefully pull the cover back through the core until Mark T emerges from Mark 2.

With Mark T and Mark 2 held tightly, smooth the core from Mark 2 toward Mark 3. Leave the tapered cover tail out. Tightly tape Mark T and Mark 2 to secure the crossover.

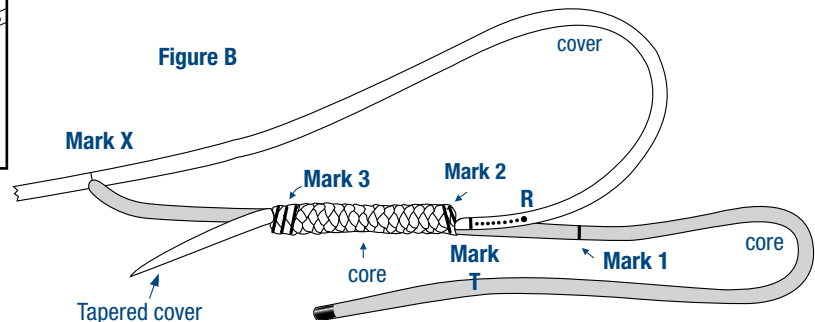
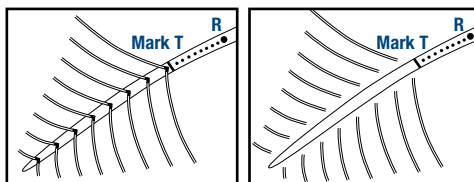
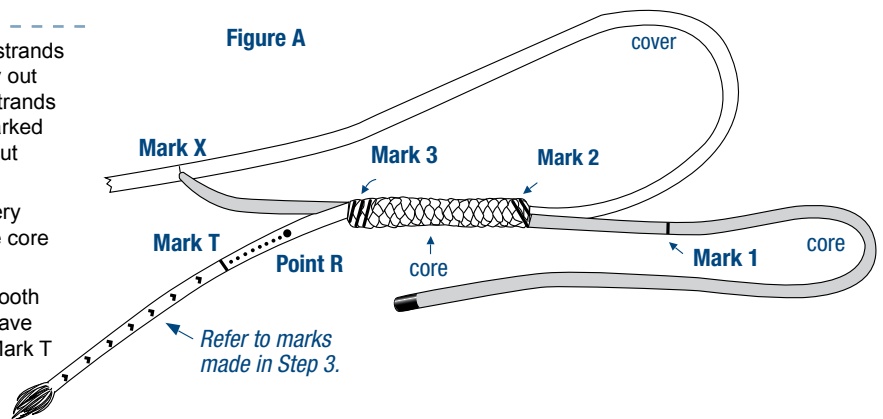



Double Braid Class I Eye Splice

STEP 6 REINSERTING THE CORE INTO THE COVER

From Mark X on the cover, measure approximately 1/3 tubular fid length toward the slip knot on the rope and mark this as Point Z. Insert the fid at the point where the strands closest to Mark T were removed for the taper in Step 5. Jam the taped core end tightly into the end of the fid. With the pusher, push the fid and core through the cover tunnel, past Mark X and through the cover at Point Z. Alternatively, you can use tape to fasten the taped core end to the fid and feed the fid towards Point Z. When pushing the fid past Mark X to Point Z, make sure the fid does not catch any internal core strands.

Note: Depending on the eye size, a fid may not be long enough to reach from Mark T to Point Z in 1 pass. If not, bring the fid out through the cover, pull the core through and reinsert the fid into exactly the same hole it came out of. Do this as many times as needed to reach Point Z.

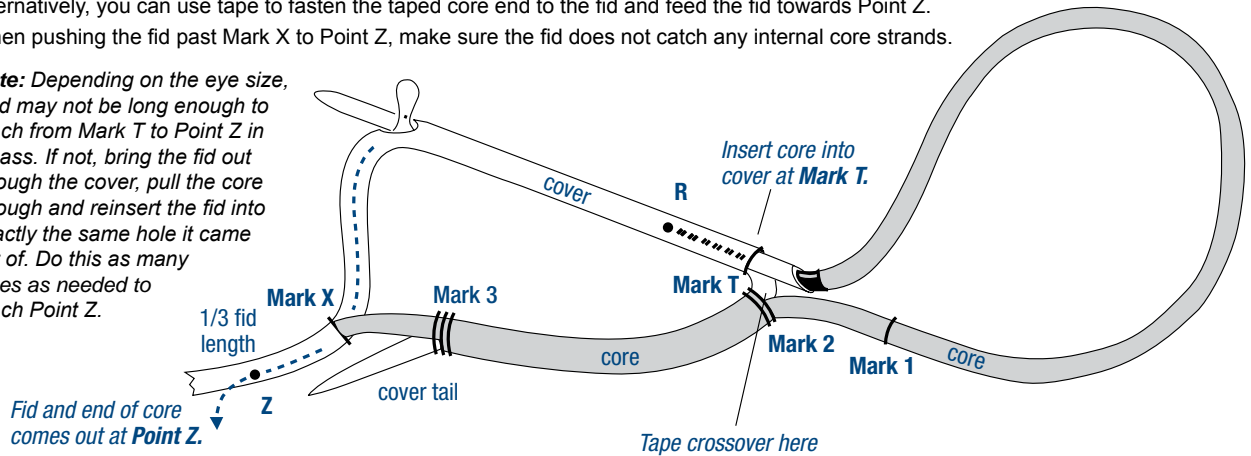

STEP 7 MARKING THE CORE TAIL FOR TAPERING

Pull on the core tail at Point Z, then pull on the tapered cover at Mark 3. The crossover should be tightened until it is approximately equal to the diameter of the rope. Smooth out the cover of the eye completely, from crossover Mark T toward Point Z, to get all the slack out of the eye area. Mark the core tail through the cover at Mark X. Also, mark the core tail where it exits at Point Z. Pull the core tail out until the mark just made at Mark X is about 6 inches beyond Point Z.

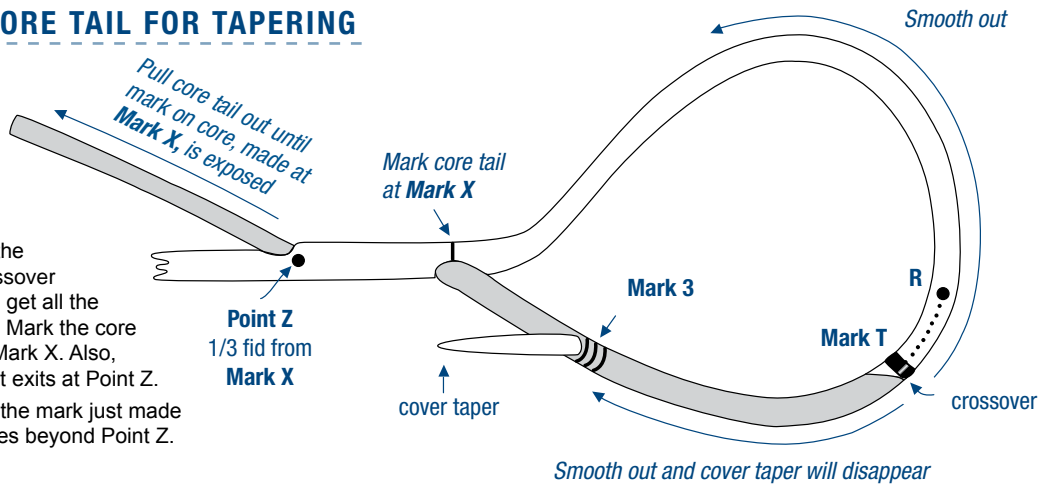

7A TAPERING THE CORE TAIL

Cut the excess core tail off at the exposed mark previously made at Point Z.

Mark the core strands for tapering based on the core construction:

- Ropes larger than 1-1/2" will have a 12-strand core; each of the 12-strands will be composed of 2 yarns.
- Ropes that are 1-1/2" or smaller have an 8-strand core; each of the 8-strands will be composed of 2 or 3 yarns.

12-STRAND CORE (1-1/2" and larger):

Mark every second right and left pairs of strands toward Mark X on the core, for 3 strands. Cut every marked strand and pull out of line (tape at end can cause resistance and may have to be removed in order to pull out cut strands.) Tapered end will now have only 6 strands remaining. Milk cover over tapered end until it disappears into the rope.

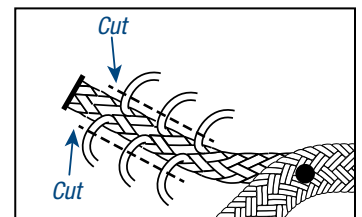
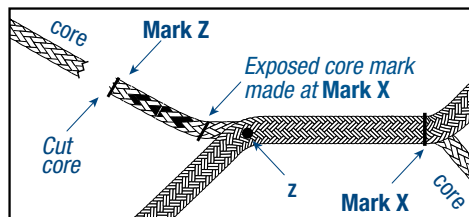

8-STRAND CORE (1-1/2" and smaller):

From the core's end, mark 4 consecutive pairs of strands, as shown. Cut and remove from the core. Milk the cover over the tapered end until it disappears into the rope.

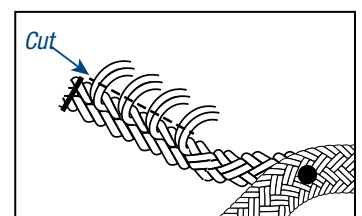
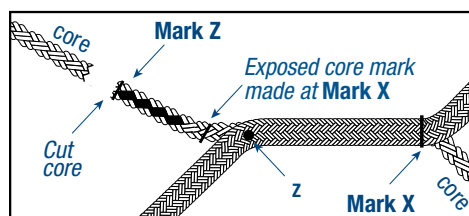



Double Braid Class I Eye Splice

STEP 8 BURYING THE EXPOSED CORE

Hold the rope at the slipknot and with the other hand milk the cover toward the splice. The cover will slide over Mark 3, Mark 2 and crossover Mark T up to Point R (it may be necessary to occasionally smooth out eye during milking to prevent reduced volume tail catching in the throat of the splice.)

If bunching occurs at the crossover preventing full burying, smooth cover from Mark T to Mark X. Grasp crossover at Mark T with one hand and then firmly smooth cover slack (female side of eye) with the other hand toward the throat (Mark X). Repeat as necessary until bunching disappears. Remove tape from crossover.

Continue milking until Point R meets Mark X.

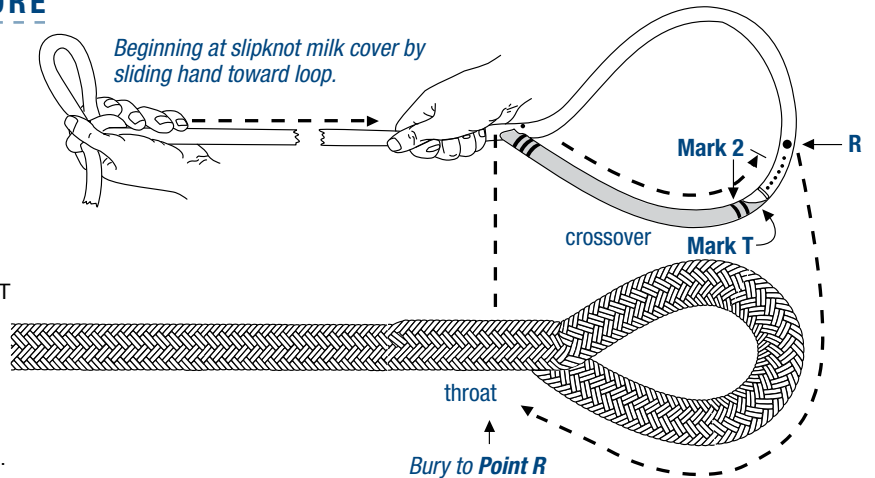

TIP: BEFORE BURYING THE CORE

A. Anchor the loop of the slipknot by tying it to a stationary object before starting to bury. You can then use both hands and the weight of your body to more easily bury the cover over the core and crossover (see Fig. A and B).

B. Holding the crossover tightly, milk all the excess cover from Point R to Mark X.

Flex and loosen the rope at the crossover point during the final burying process. Hammering the cover at Mark X will help loosen the strands.

With larger ropes it is helpful to securely anchor the slipknot. Attach a small line to the braided core at the crossover and mechanically apply tension with either a block and tackle, capstan, come-a-long, or power winch. Tension will reduce the diameter of the core and crossover for easier burying (see Fig. A).

In order to prevent no-load opening of your eye splice, Samson recommends lock stitching the eye.

Figure A

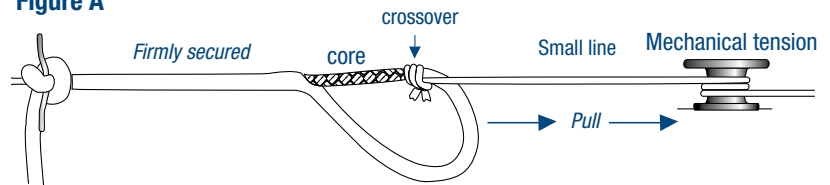
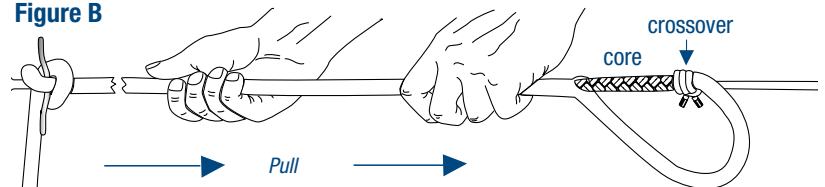

Figure B



Lock Stitching Procedure

STEP 1

Pass stitching twine through spliced area near throat of eye as shown.

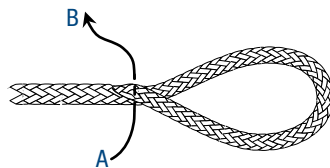

STEP 2

Reinsert twine through the rope. The twine should cover 2 strands from the exit point. Pull the twine snug, but not tight.

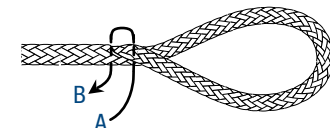

STEP 3

Continue to reinsert as shown until you have at least 3 complete stitches on each side of the rope. Each stitch should cross over 2 strands in the rope.

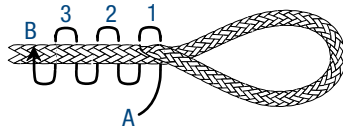

STEP 4

After completing Step 3, rotate spliced part of rope 90° and reinsert end A into spliced area in the same fashion as in Steps 1, 2 and 3. The splice will now be stitched on 2 planes perpendicular to each other. Make sure you do not pull the stitching too tight.

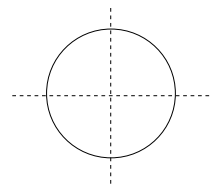

STEP 5

After stitching at least 3 complete stitches as in Step 3, extract both ends of the twine together through the same opening in the braid. Tie them together with a square knot and reinsert back into braid. For double braids, re-insert the knot between the cover and core.

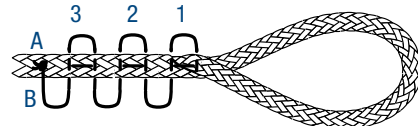



Double Braid Class II End-for-End Splice Modified for Turbo-37

THE STRONGEST NAME IN ROPE

STEP 1 MEASURING AND MARKING

On each of the 2 ends to be spliced together measure 33 times rope diameter. This is Mark 1. From Mark 1, measure an additional 20 times the diameter, this is Mark 2. Now make Mark 3, 10 times the diameter beyond Mark 2. Tape securely at Marks 3.

Note: Mark 1 on the cover is for reference only; however, each sub-rope will be marked at this location after cover removal.

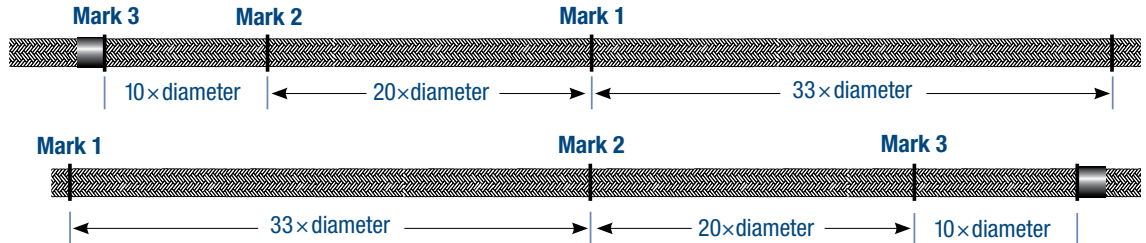

STEP 2 INSTALLING SPLICE COVER MATERIAL

Using an appropriate size and approx 1.7 times splice length of cover material (splice length approx. 60 times rope diameter), slide the cover onto either end of the rope, and slide past Mark 3. This will be used later to cover the exposed sub-ropes in the splice area.

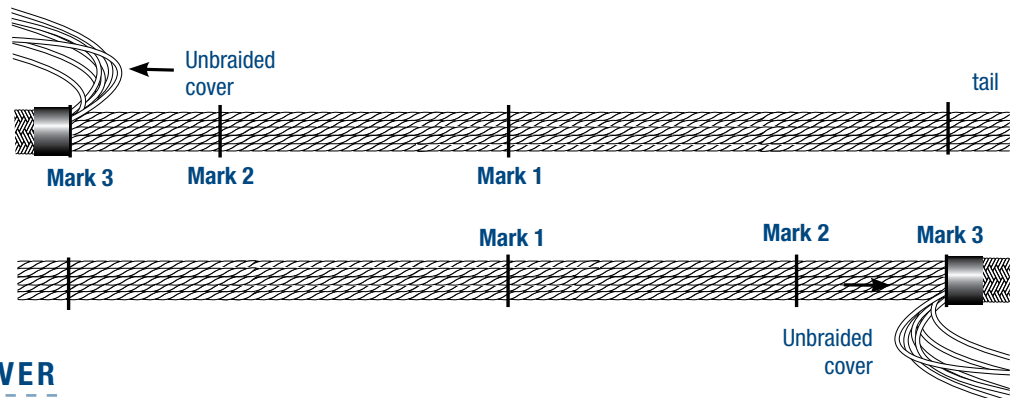

STEP 3 REMOVING COVER

Carefully cut the cover of the rope at Marks 2, and remove from rope. Unbraid the cover from Marks 2 back to Marks 3. This material will be used later to incorporate the cover into the splice.

STEP 4 TAPING SUB-ROPES

Tape the end of each sub-rope. This should be done immediately after removing the cover to prevent unlaying.

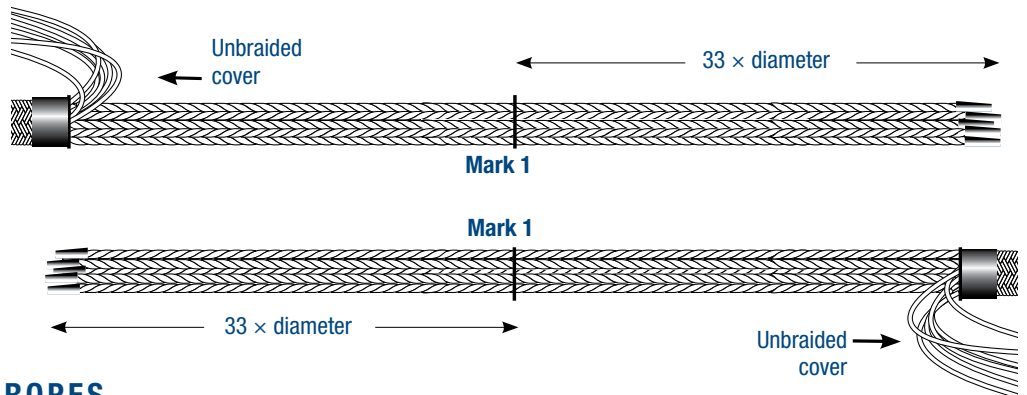

STEP 5 MARKING SUB-ROPES

Arrange sub-ropes as shown, taking care that all are laid straight. From the bitter ends of the sub-ropes, measure 33 times the rope diameter and mark each one at exactly the same point.



Double Braid Class II End-for-End Splice Modified for Turbo-37 **samson** THE STRONGEST NAME IN ROPE

STEP 6 ARRANGING SUB-ROPE

Arrange sub-ropes in groups as shown, separating the top 3, the center 1, and the bottom 3 (Fig. A).

Figure A

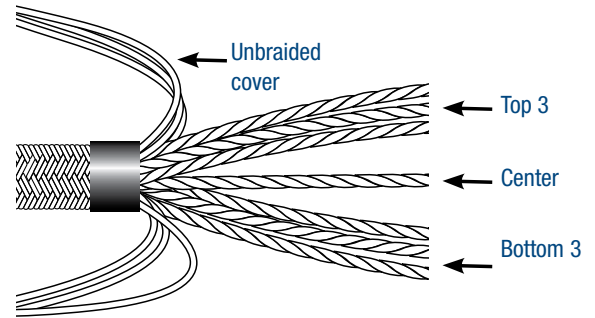

STEP 7 PULLING TOP 3 AND CENTER

Pull the top 3 and center sub-ropes out of the way on both sides (Fig. B).

Figure B

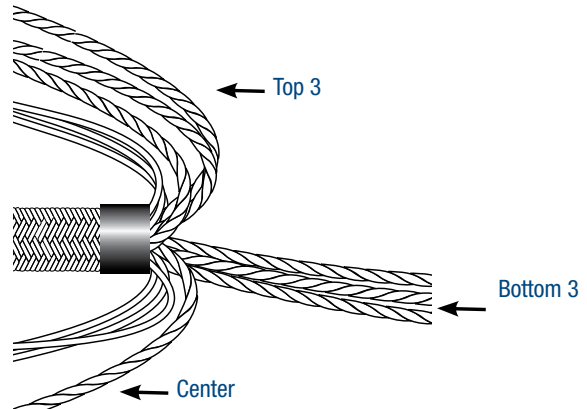

STEP 8 ARRANGING BOTTOM 3 SUB-ROPE

Arrange bottom 3 sub-ropes from each side as shown.

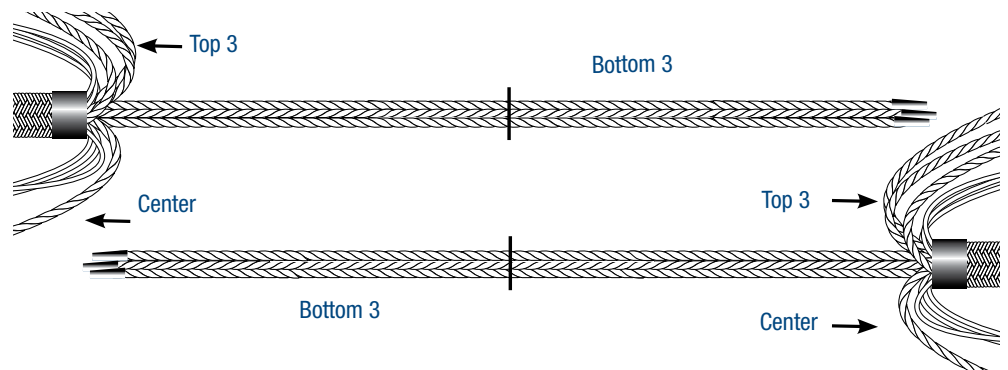
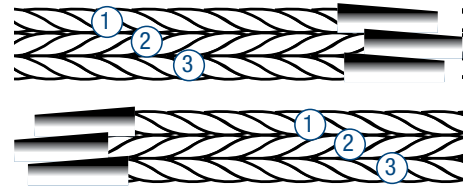

Fig. C shows how the bottom 3 strands from each side will be paired. Note that the corresponding sub-ropes from each side should have the same direction of twist.

Pairing of bottom 3 sub-ropes (sub-ropes numbered 1 will be spliced together, numbered 2 will be spliced together, etc.)

Note: After splicing bottom 3 and center 1, top 3 will be paired likewise.

Figure C



STEP 9 JOINING THE SUB-ROPE

Insert sub-rope 1 from the right into sub-rope 1 from the left by tucking under 1 strand at the mark (Fig. D). Draw the right-hand sub-rope through until the mark on it coincides with mark on the left-hand sub-rope. (Fig. E) This is the 1st tuck.

Figure D

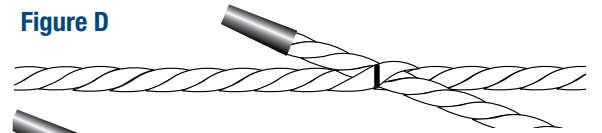
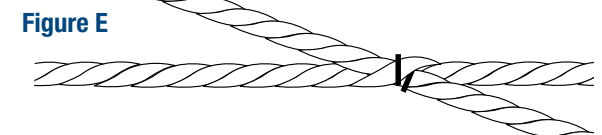

Figure E





Double Braid Class II End-for-End Splice Modified for Turbo-37 **samson** THE STRONGEST NAME IN ROPE

STEP 10 REPEAT PROCEDURE

Repeat this procedure, now tucking the left-hand sub-rope 1 into the right-hand sub-rope 1 (Fig. F). Draw the left-hand sub-rope all the way through to close up the crossover (Fig. G). Place a wrap or two of tape around the crossover point.

Figure F

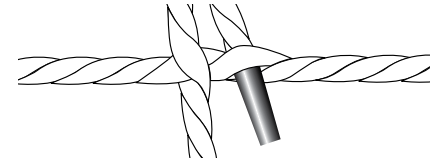
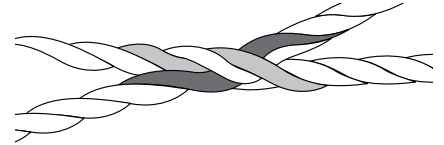

Figure G



STEP 11 MAKING ADDITIONAL TUCKS

11A Make an additional 14 tucks in each direction. A tuck consists of passing the tail over 1 strand, and under 1 strand, always against the lay. When pulling the tail through, pull perpendicular to the direction the rope is lying in, and take care not to over tighten the tuck, this will cause unnecessary distortion. Fig. G shows normal appearance after 1 tuck each direction. As the splice progresses, the tail should gradually spiral around the standing part. To accomplish this, it is necessary to pull the tail underneath the standing part on every 3rd or 4th tuck (Fig. H).

Figure H

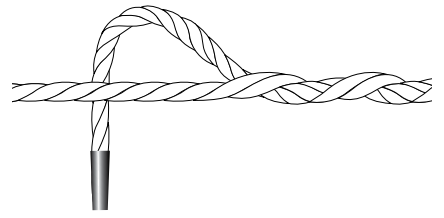
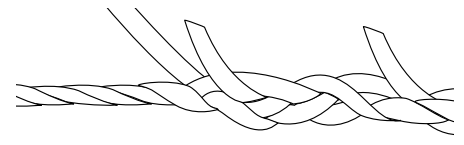
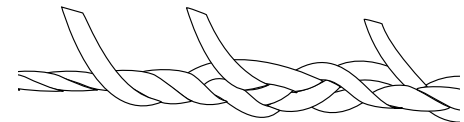

Figure I



11B Complete 15 tucks with full volume tail, then remove 1 strand from tail and complete 3 tucks with the remaining 2 strands (Fig. I). Now remove 1 strand and complete 3 tucks with the remaining 1 strand (Fig. J). Tape the tails to the rope.

Figure J



STEP 12 JOINING SUB-ROPE 2

Repeat Steps 9–11 with sub-ropes 2 (shown in Fig. K) and then sub-ropes 3.

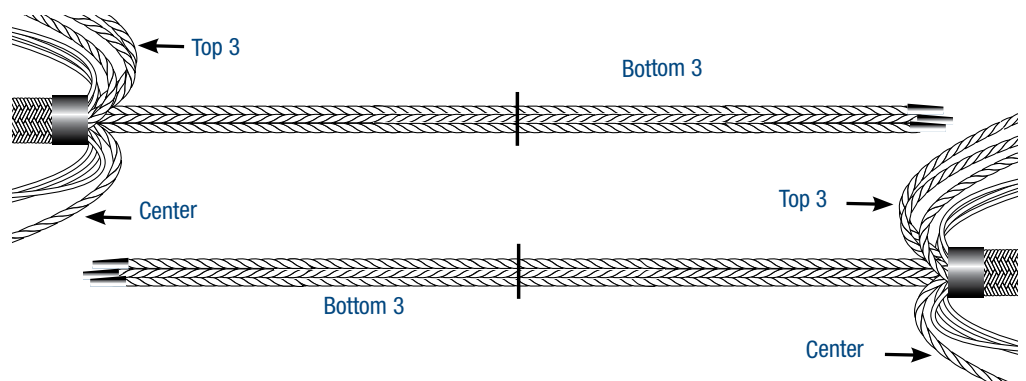
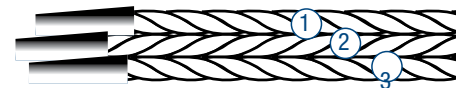
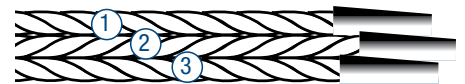

Figure K

Pairing of bottom 3 sub-ropes (sub-ropes numbered 1 will be spliced together, numbered 2 will be spliced together, etc.)

Note: After splicing bottom 3 and center 1, top 3 will be paired likewise.



STEP 13 SPLICING CENTER SUB-ROPES

Now select the center sub-ropes and splice them together, again following the procedure outlined in Steps 9–11.

STEP 14 SPLICING TOP SUB-ROPES

Arrange the top 3 sub-ropes as in Fig. 3. Starting with sub-ropes 1, splice all of the top sub-ropes as in Steps 9–11.



Double Braid Class II End-for-End Splice Modified for Turbo-37

samson
THE STRONGEST NAME IN ROPE

STEP 15 **DIVIDING UNBRAIDED COVER**
Place the rope under tension, then divide the unbraided cover material (from Step 3) at each end of the splice into 6 equal bundles.

STEP 16 **GROUPING AND TUCKING COVERS**
Tuck the cover bundles at each end of the splice. Starting at either end of the splice, take 1 of the 6 cover bundles, pass it over 1 sub-rope and under the very next (forming a simple tuck similar to that used in splicing 3-strand rope.) Repeat until all 6 bundles have been tucked once. Then tightly tape around the rope at the point where the tucks occur. Repeat this process until a minimum of 3 tucks have been made with all 6 bundles. After the last set of tucks, trim off the excess cover yarn. Now repeat entire procedure, starting at the other end of the splice. With splice area still under tension, apply tape to entire area.

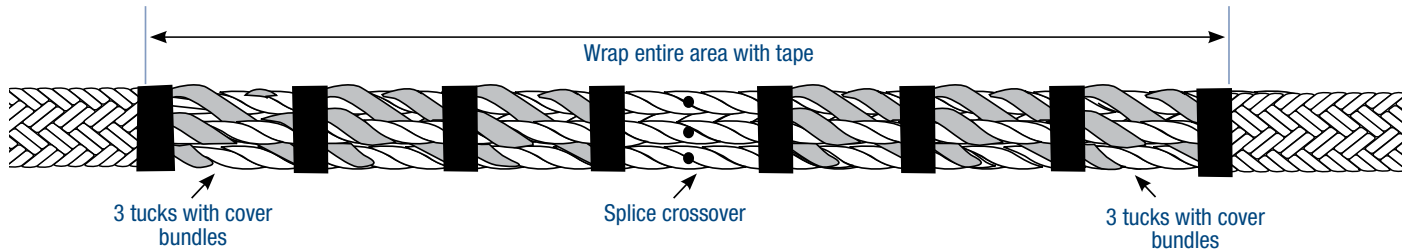

STEP 17 **COVERING THE SPLICE AREA**
Release tension and slide the section of cover on the rope in Step 2 into position over the splice with the splice crossover at the center. Remove all slack from the cover by milking away from the crossover in each direction.

Slide cover material over exposed cores. Installed in Step 2.

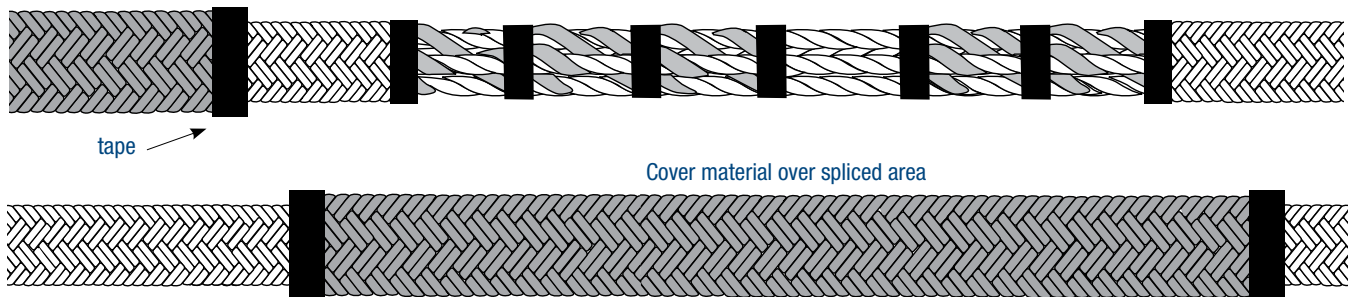

STEP 18 **SEIZING THE COVER**
Milk all of the excess cover slack from the middle of the cover material down towards both ends of line. Tightly tape the cover to the rope approximately equal to rope diameter (in inches) back from the end of the cover. Unbraid the cover strands from the tape to the end.
Seize over the area for a distance of 2 times rope diameter (in inches) with nylon seizing material.

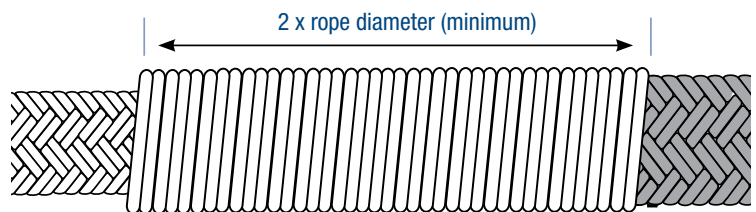

STEP 19 **GROUPING AND TUCKING COVERS**
After seizing both ends of the cover material, apply a two-part urethane coating over the seized areas as shown, extending the urethane coating 1/2 the length of the seized area on both sides of the seizing.

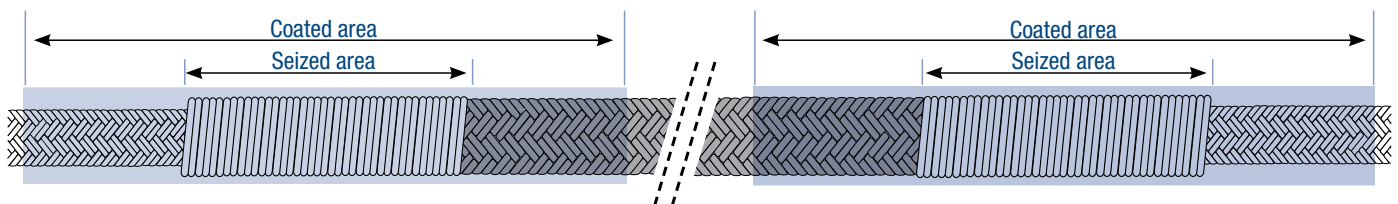



Double Braid Class II End-For-End Splice

Class II double braid ropes are made in whole or part from any of the following high modulus fibers: Dyneema®, Vectran®, Technora®, or Zylon®.

LENGTH OF Z SECTION BASED ON SIZE OF ROPE AS FOLLOWS:

Size (Dia.)	1/4"	5/16"	3/8"	7/16"	1/2"	9/16"	5/8"	3/4"	7/8"	1"	1-1/8"	1-1/4"	1-5/16"	1-1/2"
Z Length	5"	5"	5"	5"	5"	7"	8"	8"	10"	12"	14"	14"	15"	15"

STEP 1 MEASURING AND MARKING

From the end of **each** rope, measure and mark as follows:

1A 2 fid lengths from end – Mark 1 on cover and core

1B From Mark 1 measure Z section lengths towards end of rope. (Mark cover only)

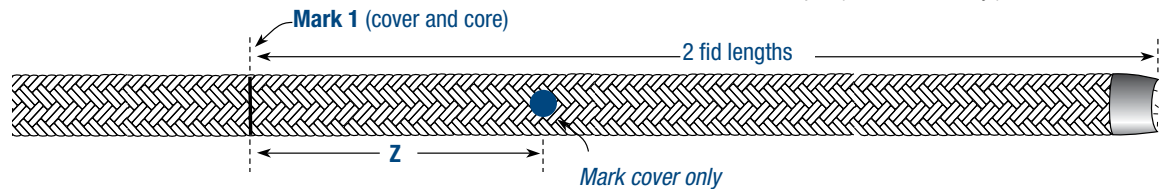

STEP 2 KNOTTING AND POSITIONING

Measure back 6 fid lengths from Mark 1 and knot or spike each rope. Position ropes as shown.

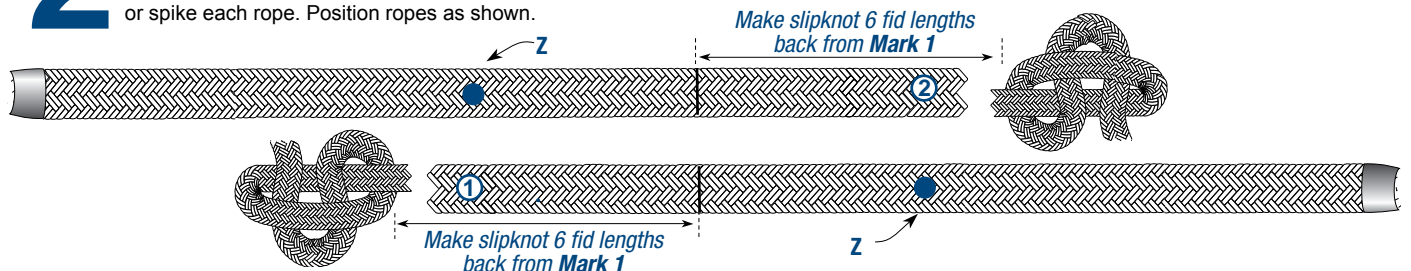

STEP 3 EXTRACTING AND MARKING CORES

Extract cores at Z Marks and pull out completely from the ends of the ropes. Tape core ends. Slide covers back toward knots/spikes, enhance Mark 1 on each core. Measure 2-1/2 fid lengths from core Mark 1 toward knots/spikes and make core Mark 2 on each core.

Extracting the core: Bend rope sharply at Z. With the pusher or any sharp tool such as an ice pick, awl, or marlin spike, spread the cover strands to expose core. First pry, then pull the core completely out of cover.

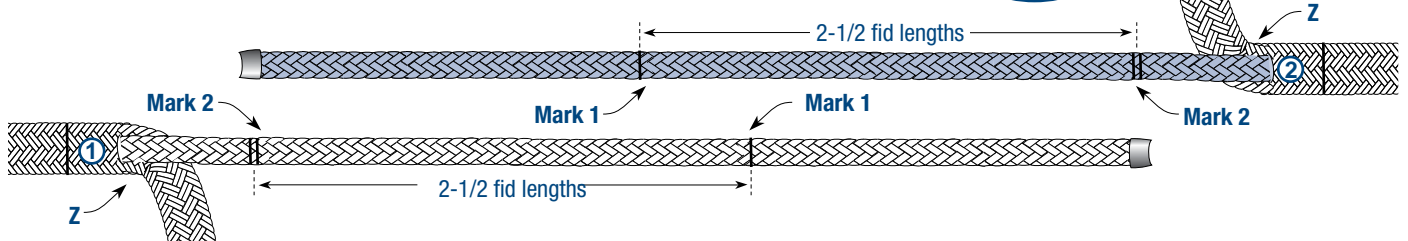
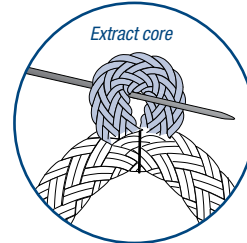

STEP 4 BURYING CORES

Insert the end of each core into the opposing core at Mark 1 and out at Mark 2. Inserting the core ends 1 pick down from Mark 1 on the entrance side of each core allows for a smoother crossover.

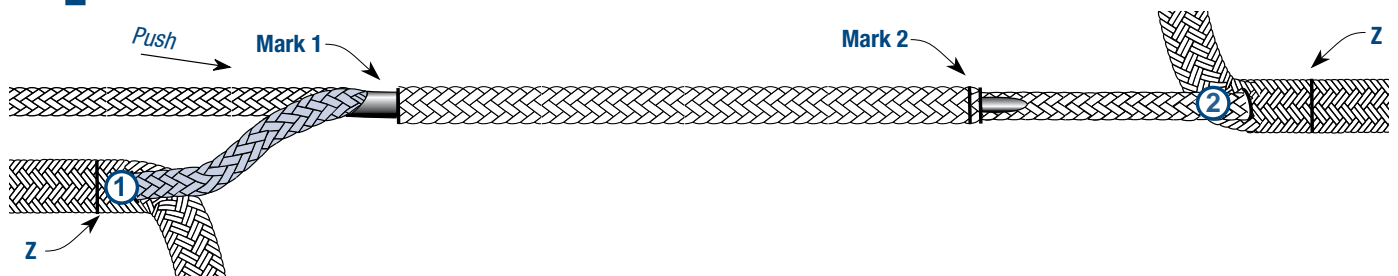



Double Braid Class II End-For-End Splice

STEP 5 TAPERING CORE TAILS
From cut end, mark strands as shown. Cut and remove strands to form a tapered tail.



STEP 6 TIGHTENING CROSSOVER
Tighten crossover by milking towards the crossover from each direction.

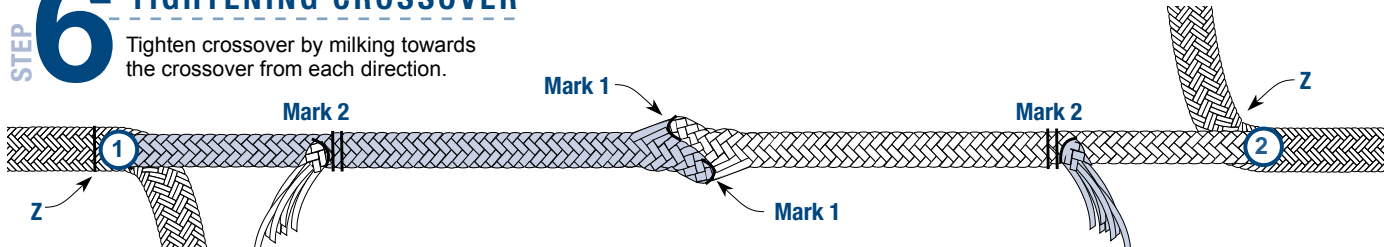

STEP 7 RECOVERING CORE
7A Milk away from the crossover in both directions. Tapered tails will disappear. Repeat until all slack is removed. The crossover and entire splice length should be smooth.

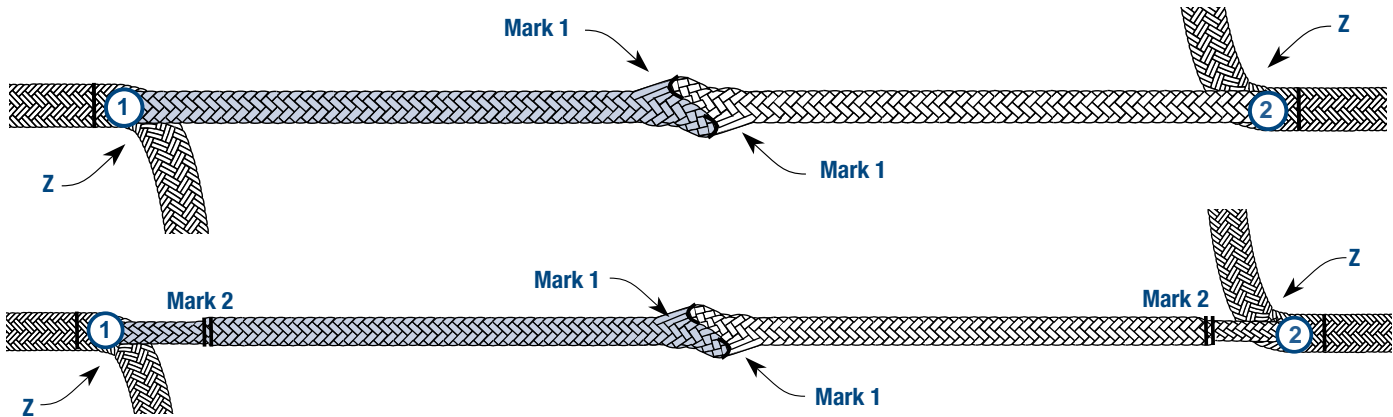

7B Milk the cover towards the crossover. Work one side at a time, hand tensioning the core splice area while working the cover up over it. Covers should meet at, or near, the crossover. Lock stitch and whip each side of crossover and through cover tails.

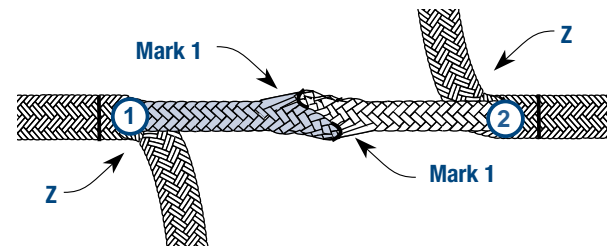

STEP 8 LOCK STITCH AND WHIP
Lock stitch

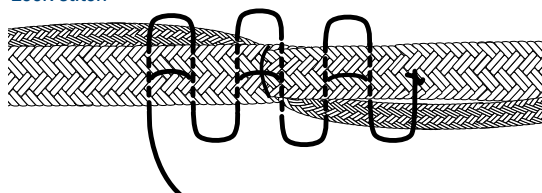

whipping

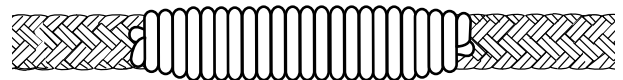

Finished splice



Double Braid Class II Eye Splice for TS-II Turbo™

STEP 1 MEASURING AND MARKING

The measurements are the same as those for the direct bury eye splice for Class II ropes. Measure 3 fid lengths from the end and make Mark 2.

Form the desired size of the eye, and make Mark 3 adjacent to Mark 2. From Mark 3, measure 3-1/2 fid lengths and make Mark 4.

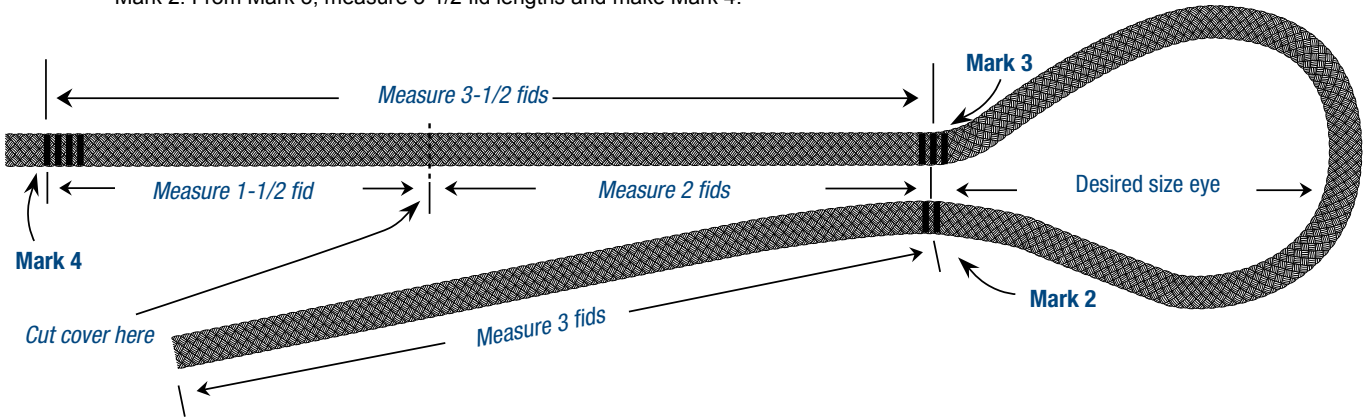

STEP 2 INSTALLING DC GARD FOR SPLICE AREA

The splice area must be covered with DC Gard at the completion of the splice. Cut a piece of DC Gard that is 5-1/2 fid lengths long (the distance from Mark 3 to Mark 4 plus 2 fid lengths.) Slide the DC Gard onto the rope and beyond Mark 4*.

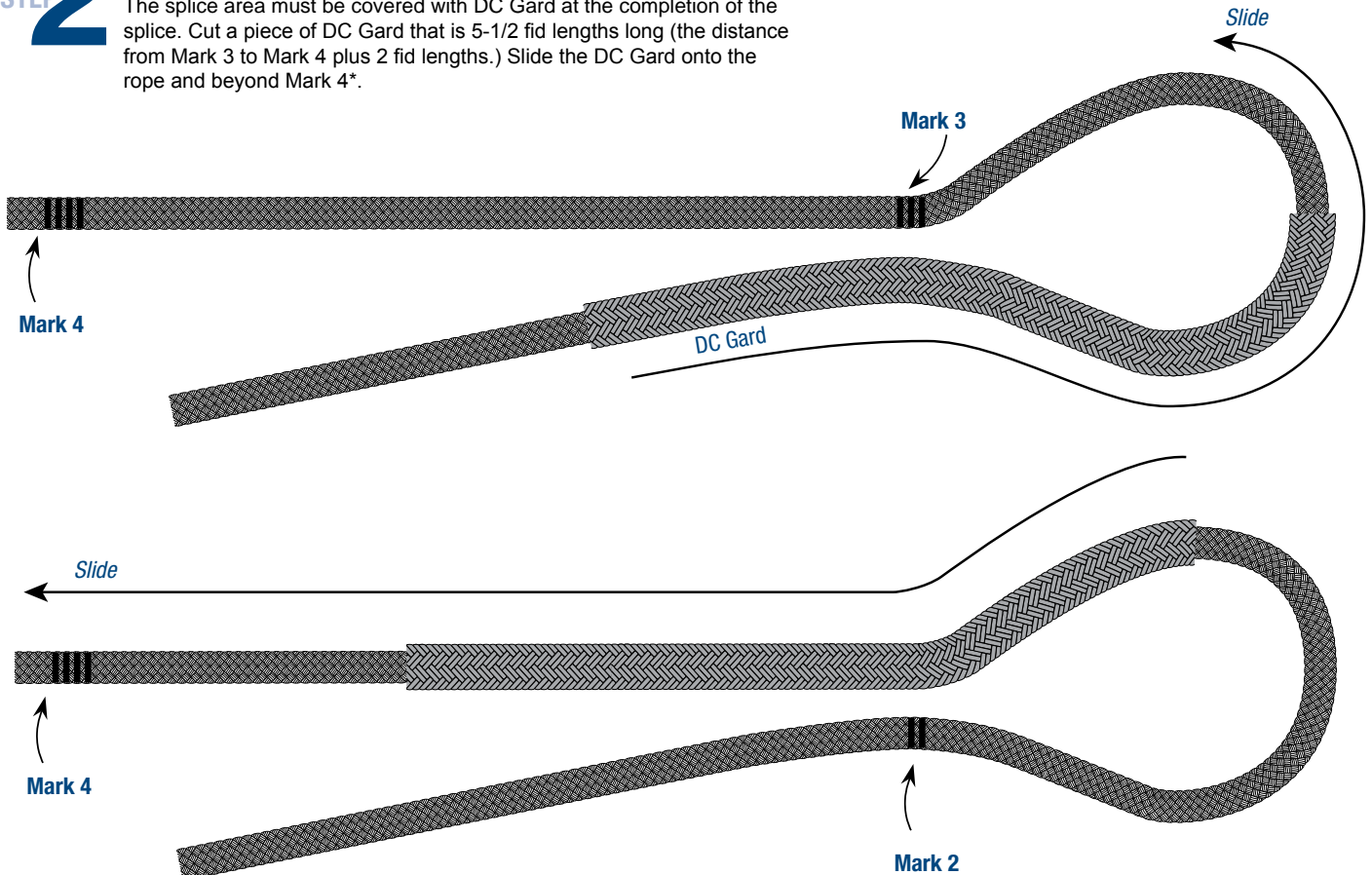

*For field splicing, replace DC Gard with whipping twine. See instructions for whipping on page 182 for more information.



Double Braid Class II Eye Splice for TS-II Turbo™

STEP 3 UNBRAIDING COVER

Tape the rope at Marks 2, 3 and 4. From Mark 3, measure 2 fid lengths towards Mark 4. Mark this point, then cut the cover completely around the circumference of the rope. Be careful not to cut any of the core strands or yarns.

Unbraid the cover from the cut towards Mark 4, and from the cut towards Mark 3. The cover is left intact around the eye, from Mark 2 to Mark 3. With the cover unbraided, transfer Mark 2 and 3 to the core.

Unbraid the cover from the bitter end to Mark 2. After the cover has been unbraided, measure 1 fid length from the bitter end and make Mark 1.

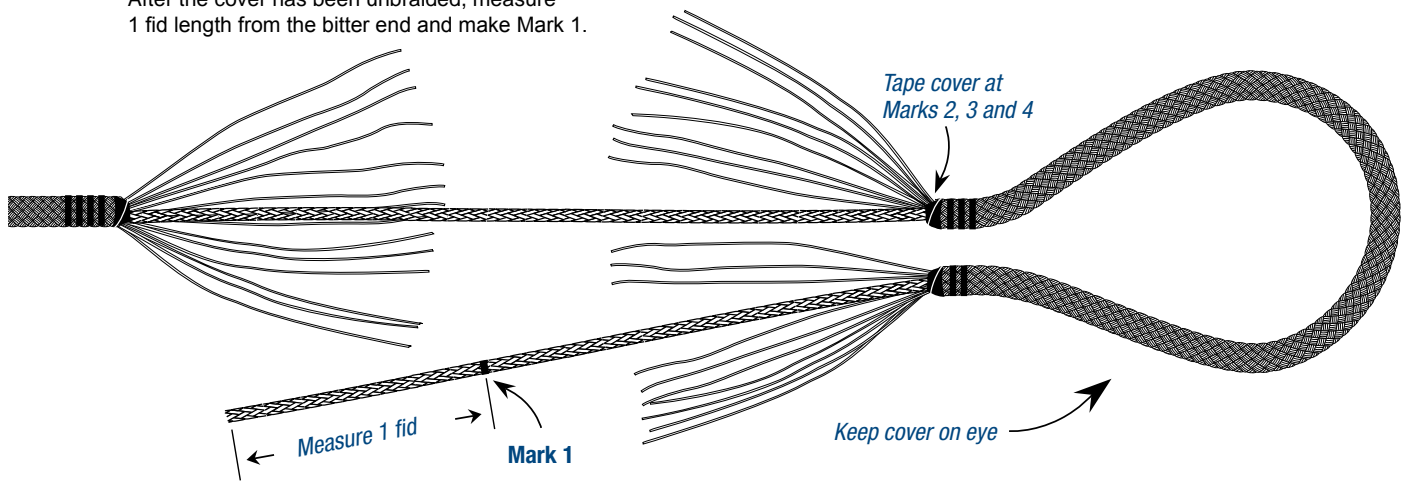

STEP 4 PERFORMING EYE SPLICE

4A REMOVE REINFORCING CORE

Measure 1 fid length from Mark 4 towards Mark 3. Open up the strands of the core to expose the Duravet reinforcing core. Cut the reinforcing core at this point. Remove the Duravet core from this point to the bitter end of the rope.

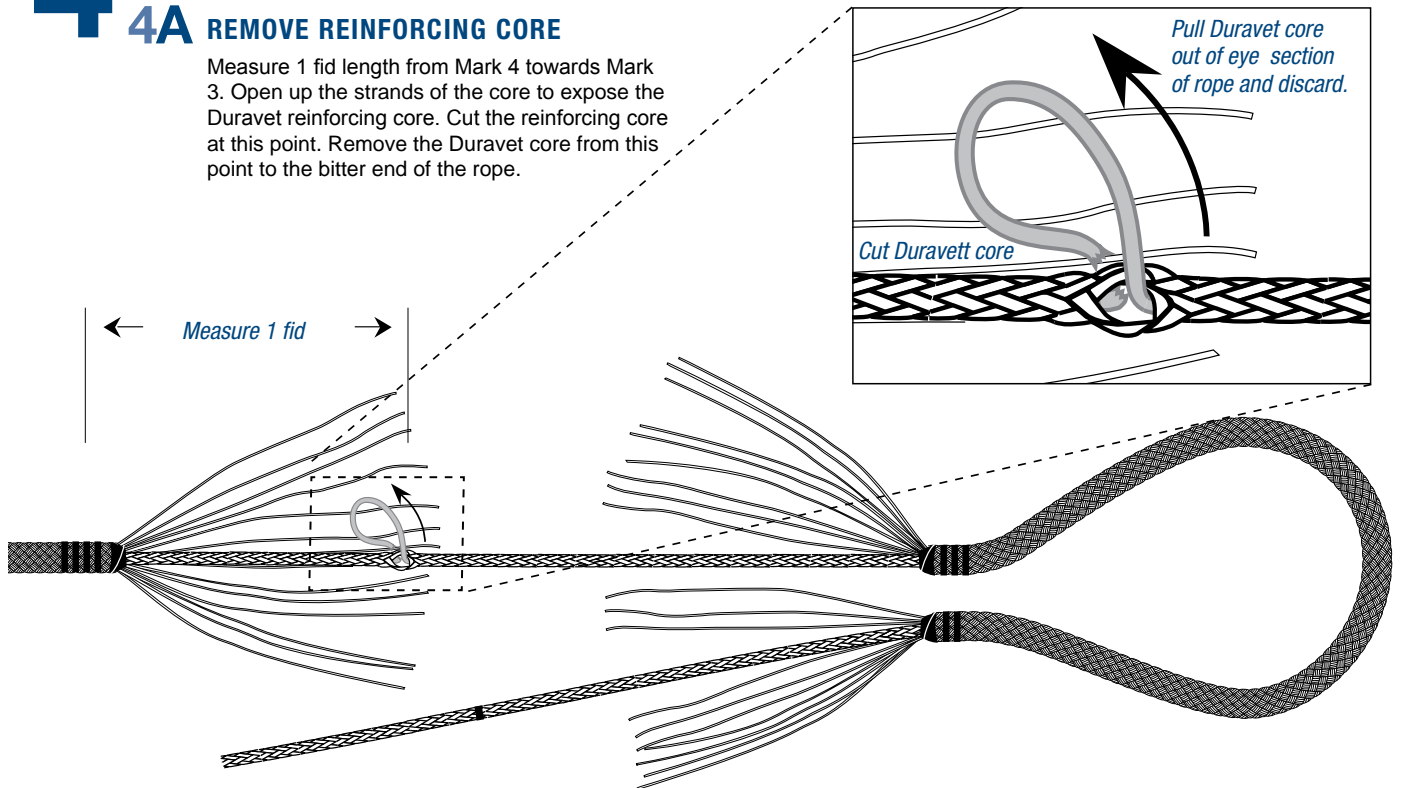



Double Braid Class II Eye Splice for TS-II Turbo™

samson
THE STRONGEST NAME IN ROPE

4B MAKING TAPER

From Mark 1, in the direction of the bitter end of the line, mark every second right and left strand for 3 strands. Cut every marked strand and pull out of line (tape at end can cause resistance and may have to be removed in order to pull out cut strands.) Tapered end will now have only 6 strands remaining. Tape tapered tail tightly to keep from unbraiding.

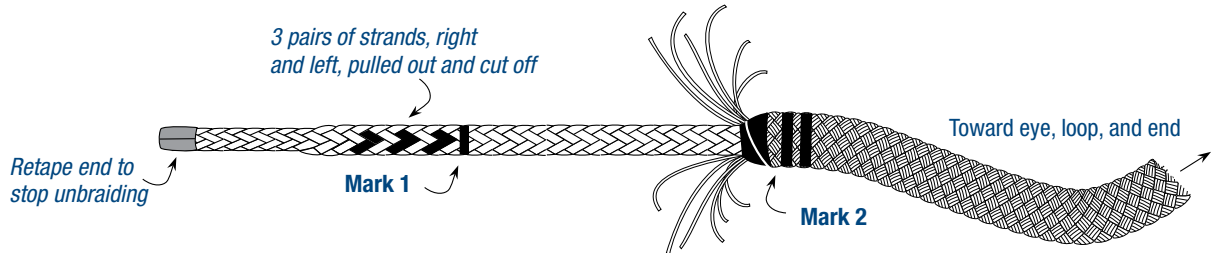

4C BURYING TAIL INTO STANDING PART OF LINE

Measure 3-1/2 tubular fid lengths from Mark 3 on the core and make Mark 4 on the core. Insert fid and tapered tail at Mark 3 and bring fid out at Mark 4. You may need to slide the cover back at Mark 4 slightly. Pull fid and tapered tail out. Don't let the line twist. Use care when the tail passes the cut end of the Duravet core.

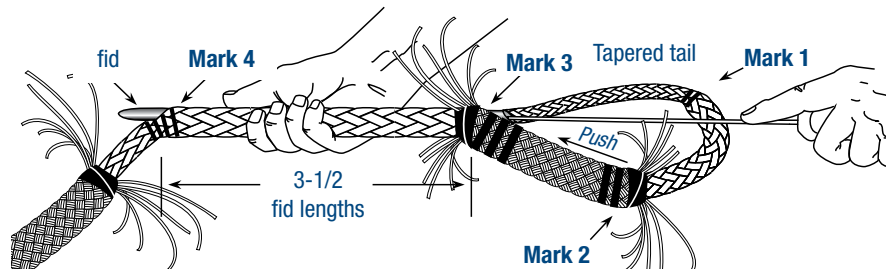

4D FINISH BURYING TAIL

Pull tail out of the rope to expose the previously tapered area. Remove the fid and any tape at the end of the tail. From the end of the tail, mark 3 consecutive strands, as shown. Pull them out of the braid and cut off close to the body of the rope. Now, using both hands and the weight of your body, smooth the cover slack from Mark 3 towards Mark 4. The tail will disappear into the rope, and a smooth, gradual taper should result.

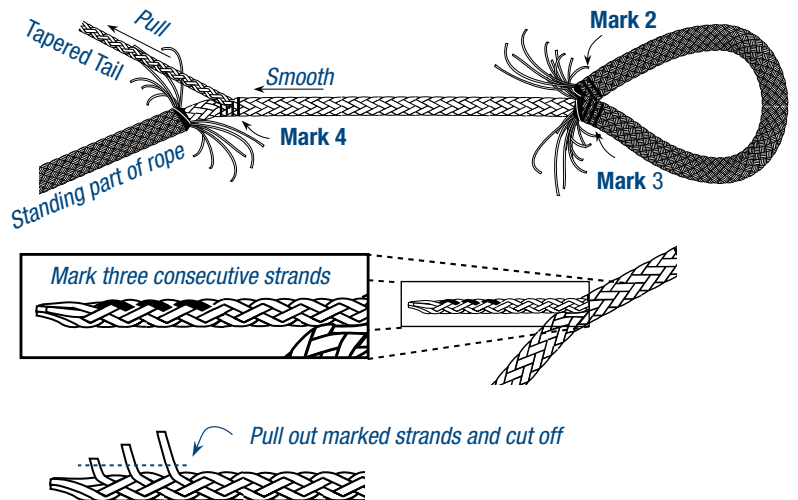

4E FINISHING EYE SPLICE

When finished, Mark 2 and Mark 3 should be at the same point in the vertex of the eye—which yields eye size desired.

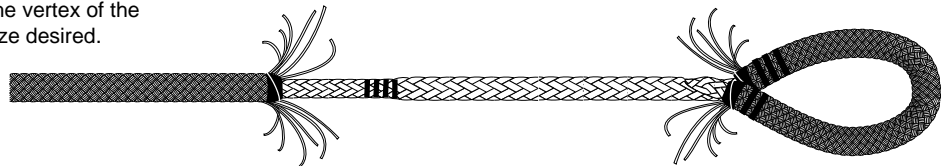



Double Braid Class II Eye Splice for TS-II Turbo™

STEP 5 GROUPING COVER STRANDS

At Mark 4, divide the cover strands into 6 equal groups. Tape the ends securely.

At the vertex of the eye, group the cover strands at Mark 3 into 3 equal groups, and group the strands at Mark 2 into 3 equal groups. Tape the ends of each strand.

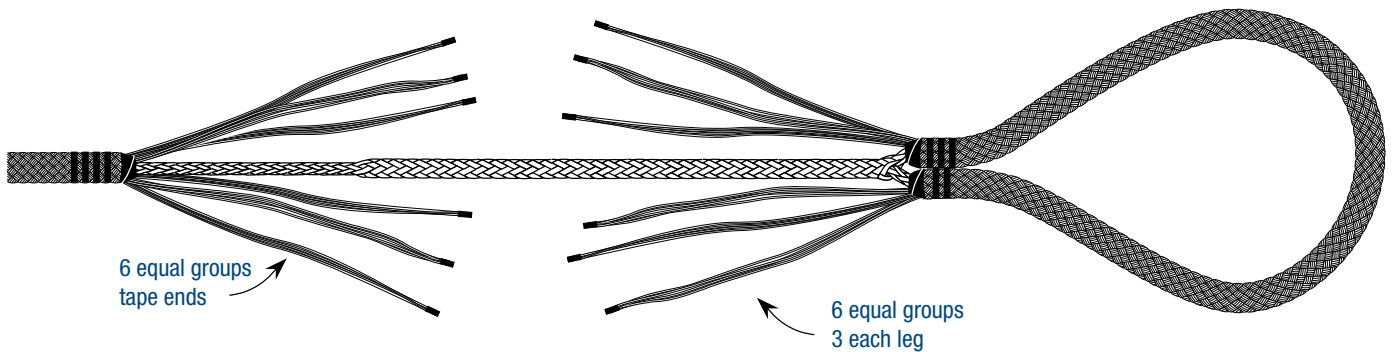

STEP 6 WEAVING COVER GROUPINGS: WORKING END

Now, working from Mark 4 towards Mark 3, make 5 tucks with the cover strands into the core in the following pattern: under 1 strand, over 4 strands, under 1 strand, over 5 strands, under 1 strand, over 4 strands, under 1 strand, over 5 strands, under 1 strand.

These tucks proceed straight down the axis of the rope. Tuck all 6 strand groups in the same pattern

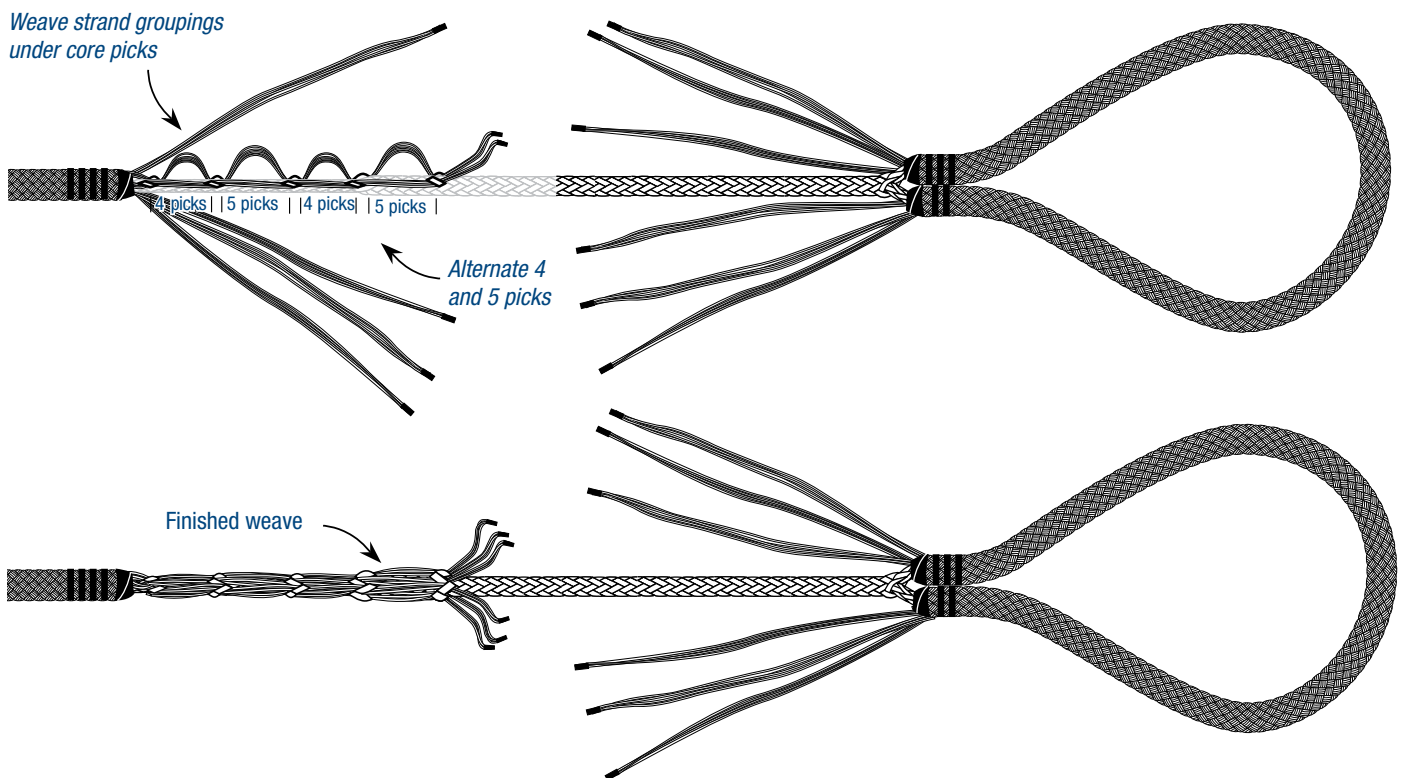



Double Braid Class II Eye Splice for TS-II Turbo™

STEP 7 WEAVING COVER GROUPINGS: EYE END

Working from the eye towards Mark 4, perform 5 tucks of the cover strands in the same alternating pattern; over 1 and under 4, over 1, under 5. The 2 groups of cover strands should meet near the point where the cover was initially cut, 2 fid lengths from Mark 3, and 1-1/2 fid lengths from Mark 4.

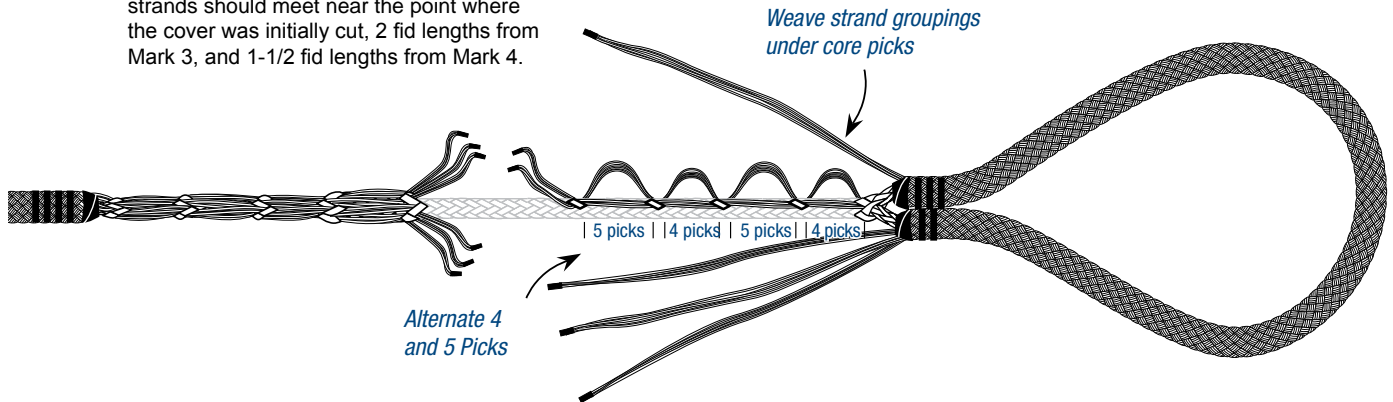

STEP 8 TRIMMING BACK TAPED TAILS

Cut back the cover tails leaving a 1/2 fid length of tail exposed and arrange them so they lay as close to the body of the rope as possible. Tape them down.

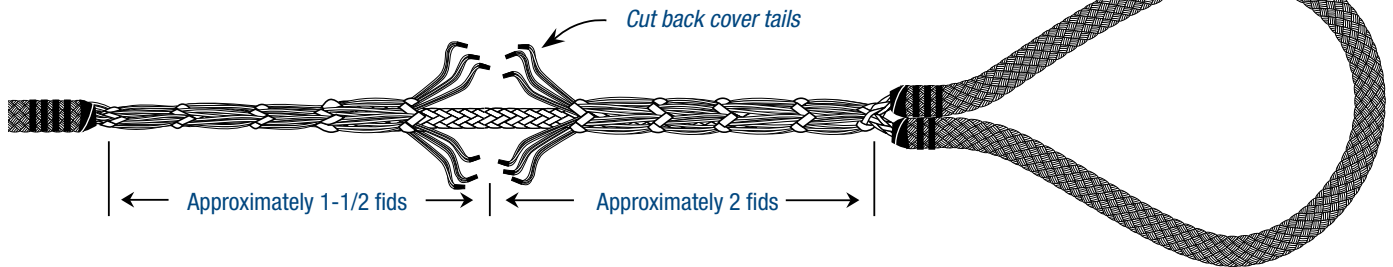

STEP 9 TAPING TAILS

Tape over the exposed tails with enough tape to adequately cover the tails, plus an extra 1/2 fid on each side.

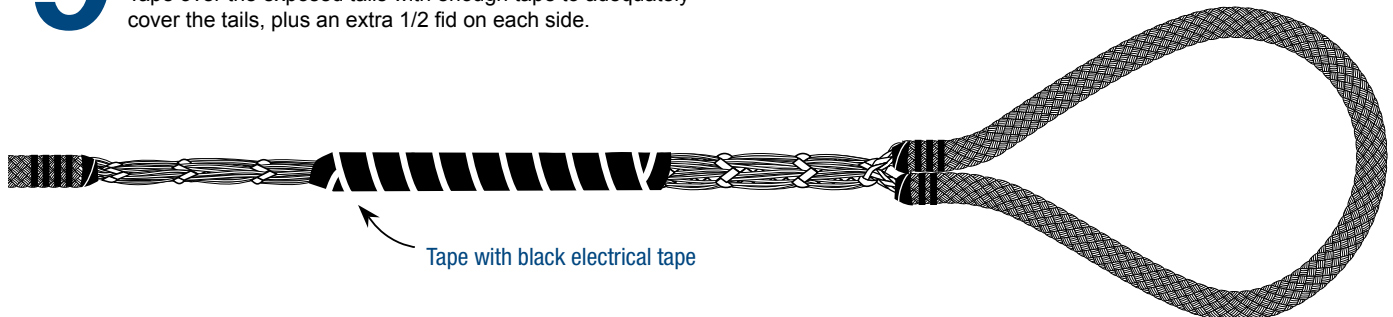



Double Braid Class II Eye Splice for TS-II Turbo™

STEP 10 ATTACHING DC GARD COVER

10A Slide DC Gard over splice area.

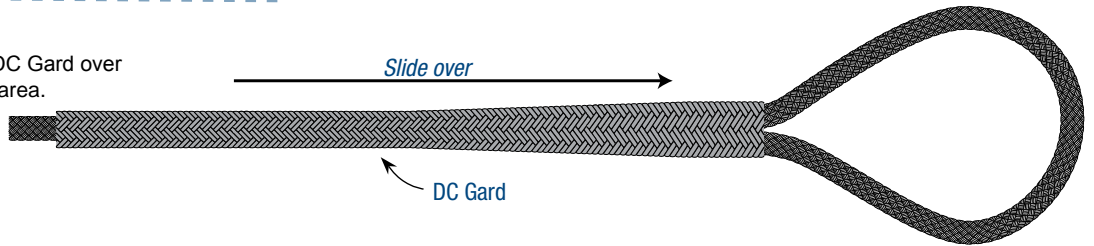

10B Unbraid 1 fid length of the DC Gard and divide into 4 equal groups

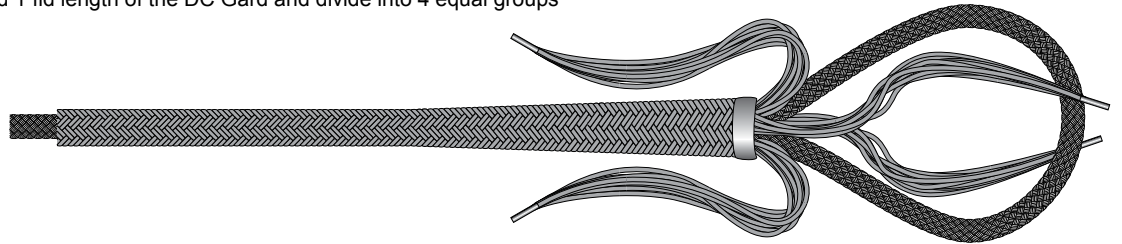

10C Insert the strand groups on the sides of the splice into a tubular fid pass them between the splice and the DC Gard cover a distance of 3/4 of a fid length and exit through the DC Gard cover. Trim DC Gard strand group ends flush with DC Gard Cover where they exit.

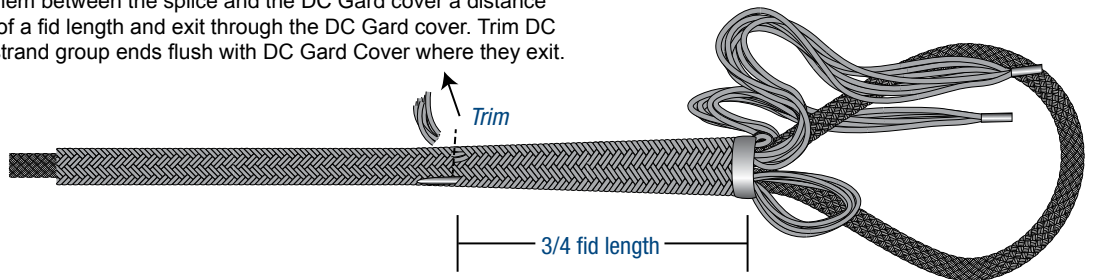

10D DC Gard strand group positioned on the bottom of splice is passed between the legs of the eye and through the inside of DC Gard cover on opposite side exiting through 3 picks down from the vertex.

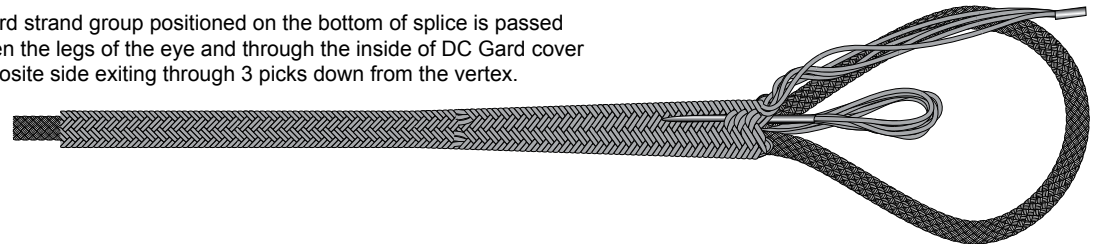

10E Remaining DC Gard strand group will pass through the eye in the opposite direction from the first group and through the inside of the DC Gard cover on the opposite side exiting 3 picks down from the vertex.

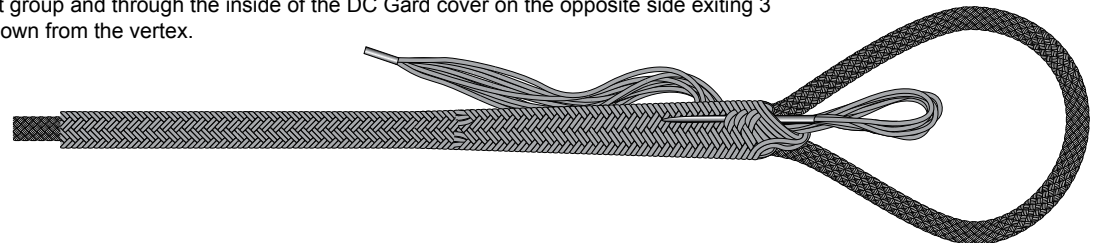



Double Braid Class II Eye Splice for TS-II Turbo™

10F Begin tucking DC Gard strand groups over 2 strands and under 3 strands (1 tuck) and complete 4 tucks. Bury the remaining length of strand groups between DC Gard cover and rope a minimum of 1/2 a fid length, trim DC Gard strand group flush with cover. Turn rope over and repeat for the remaining strand group.

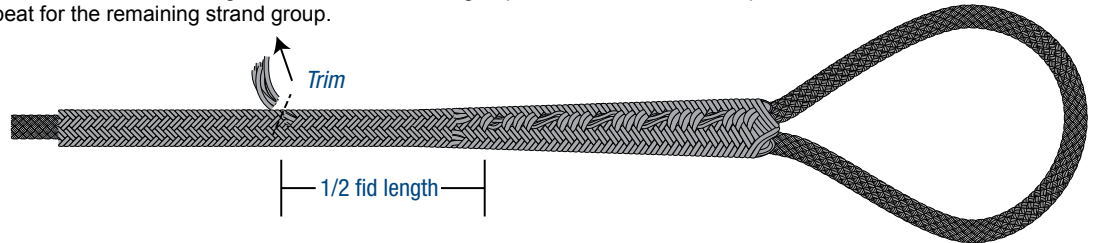

10G Milk DC Gard cover down from eye the toward working end.

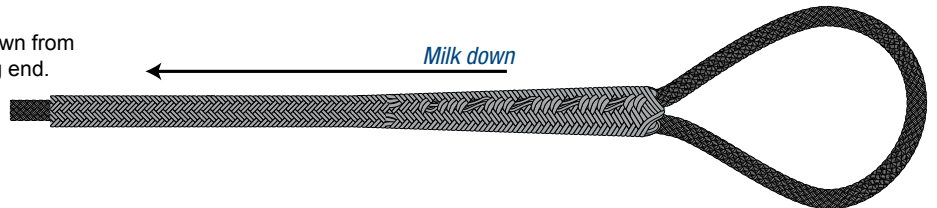

10H Tape 6 inches tightly at the throat of splice and 12 inches at base of DC Gard cover.

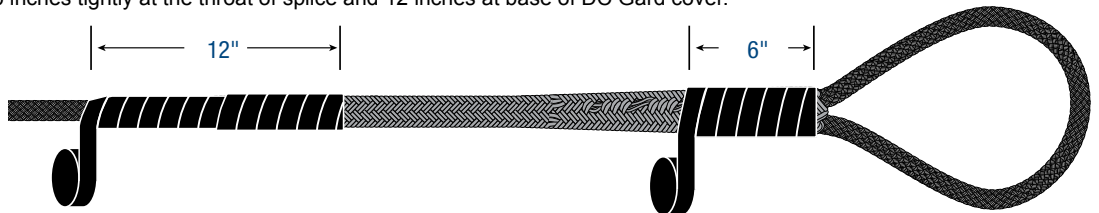

10I Seize twine over taped area. See page 8 for more information on seizing.

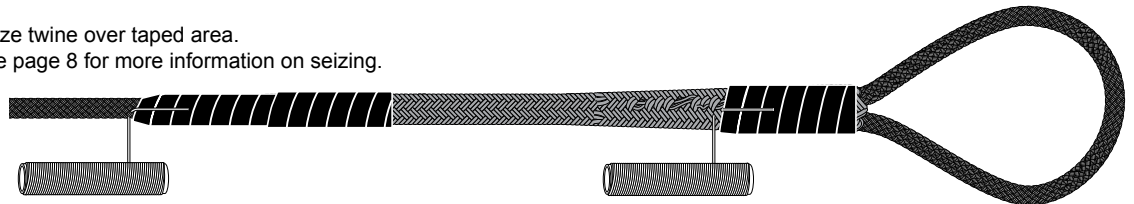

10J Apply two-part urethane over seized area.

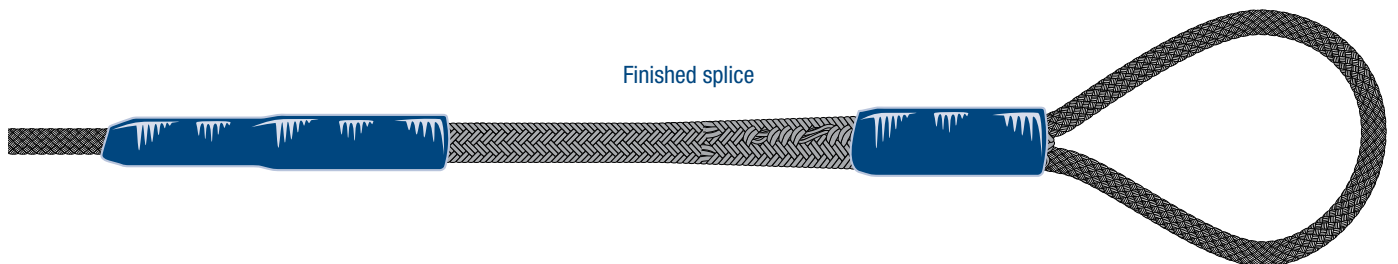
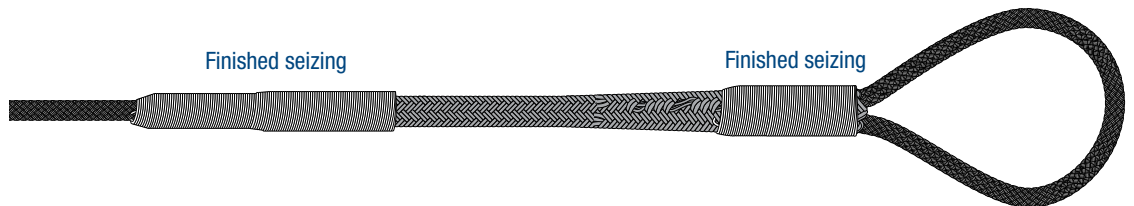



Seizing Finished Splice

STEP 1

Attach twine to netting needle.

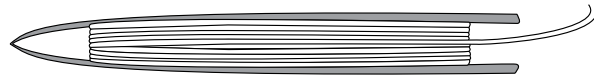

STEP 2

Pass the free end of the twine under a couple of strands in the cover and pull enough twine through to extend beyond the area to be seized.

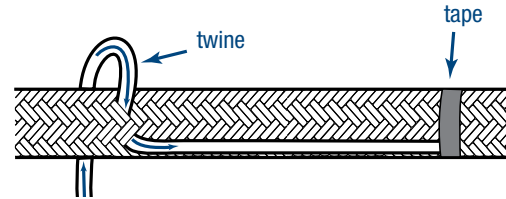

2A Tape the free end of the twine to the opposite side of the area to be seized.

STEP 3

Start seizing. Wrap the needle around the circumference of the rope 1 complete turn. Pass the netting needle under the complete wrap left to right. Pull the loop tight. Pull the needle up maintaining tension on the completed half hitch and then quickly pull back down to lock the half hitch in place.

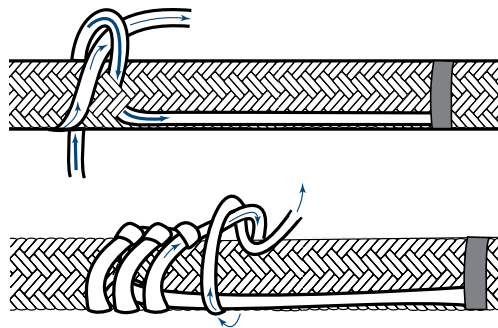

STEP 4

Continue with this procedure until the seized area is approximately 1/2 of the desired length, then cut off the taped end near the last wrap.

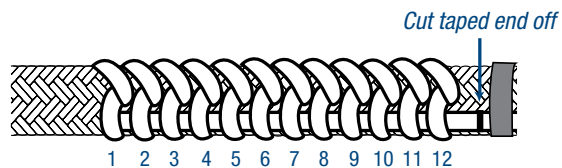

STEP 5

Using some spare twine, tape a loop that covers the length of the intended seizing distance, letting the 2 free ends of the looped twine lay over the completed seizing. Tape the free ends of the loop past the already seized area.

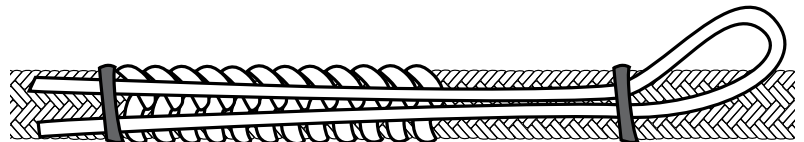

STEP 6

Continue seizing for the desired total length over the top of the looped twine. After seizing is complete, pass the exposed seizing twine through the loop. Remove the tape on the looped twine and pull the ends to draw the loop under the seizing.

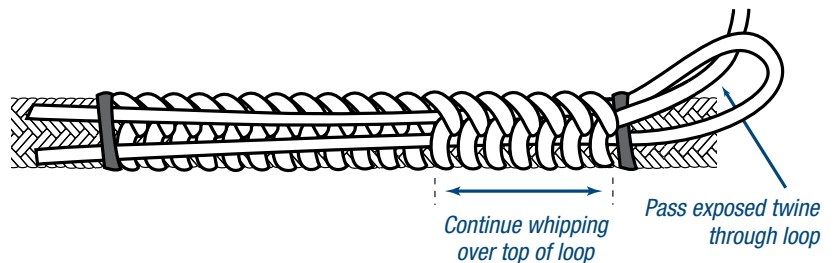

STEP 7

Pull the loop through the seized area. This should place the remaining seizing twine under the seized area. Cut off any excess twine.





Double Braid Class II Eye Splice for TS-II™ / TS-II Premium™

samson
THE STRONGEST NAME IN ROPE

For all measurements use fid 1 size larger than rope.

Note: For 1/2" use 9/16" fid, for 5/8" use 3/4" fid, etc.

Note: Fid length for measurement purposes is 21 x rope diameter.

Example: For 5/8" rope use 3/4" fid.
Fid length = .75 x 21 or 15.75"

STEP 1

PREPARING THE ROPE

Tie the rope to a fixed object approximately 12 fid lengths from the end, then place pin through cover and core near knot.

- 1A** Slide taped end of cover back from end of core. Measure 1/4 fid length from end of exposed core and make a mark. Cut core off at mark.

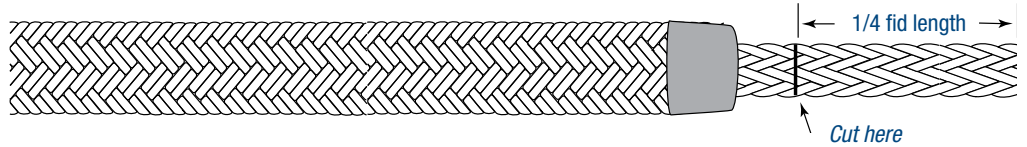

- 1B** Leaving a small amount of core protruding from cover, grasp the taped end tightly with one hand, and with the other hand milk the cover back towards the pin. Pin back cover slack. Place second pin to hold back cover slack.

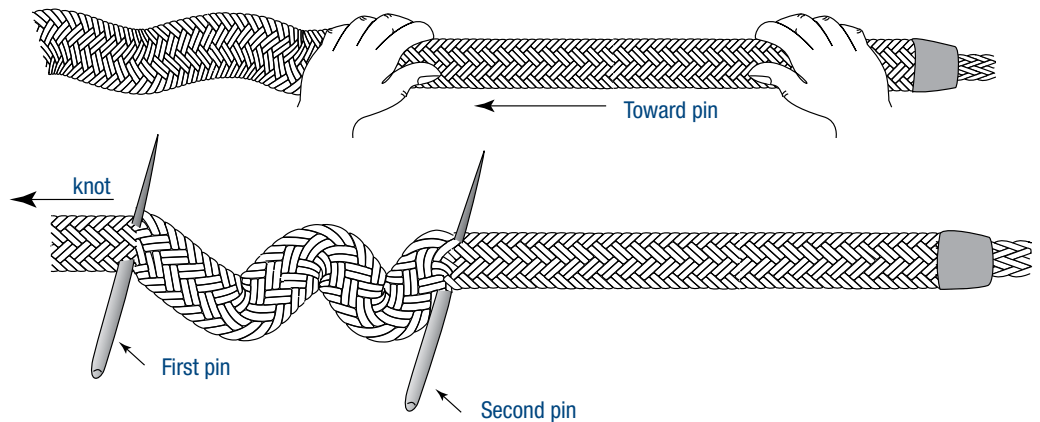

STEP 2

MEASURING AND MARKING

From taped end, measure 1 fid length and make Mark 1. From Mark 1, measure another fid length and make Mark 2. From Mark 2, form desired eye size and make Mark 3. At Mark 3, press felt pen through cover and make a mark on the core.

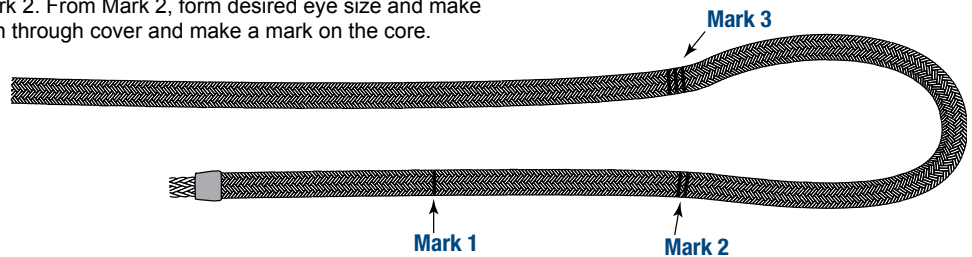

- 2A** Straighten the rope out and place a pin through cover and core between Marks 2 and 3. Remove the pin holding back the extra cover slack and milk the cover slack back towards Mark 3.

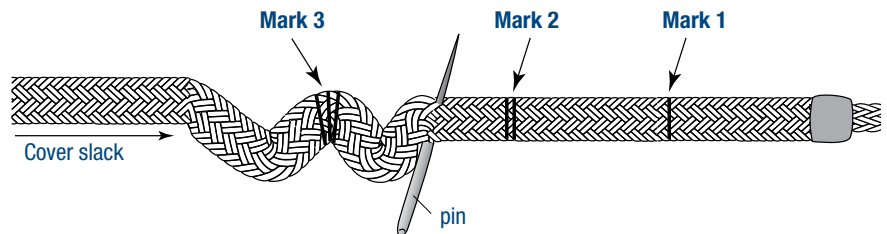



Double Braid Class II Eye Splice for TS-II™ / TS-II Premium™

samson
THE STRONGEST NAME IN ROPE

STEP 3 EXTRACTING THE CORE

Bend rope sharply at Mark 3. Using an awl or similar device, carefully pry the cover strands apart to create an opening. Using the awl, carefully pry the core out of the cover. Make sure the pin placed between Marks 2 and 3 stays in place.

3A With rope positioned as shown, pull on core in the direction shown. You will need to expose a minimum of 3 fid lengths of core.

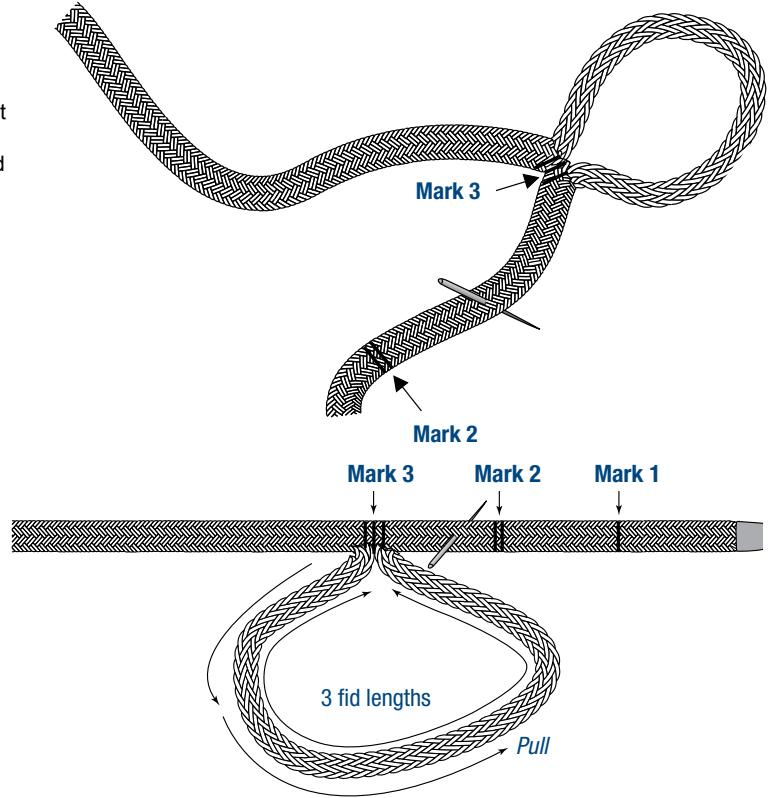

STEP 4 MARKING THE CORE

Find the mark on the core made previously through the cover at Mark 3. This is Mark A. From Mark A, measure back a distance of 1-1/4 fid lengths, make Mark B. From Mark B, measure back a distance of 1-1/2 fid lengths and make Mark C.

4A Bend the primary (load bearing) core sharply at Mark B. Carefully pry the strands apart to expose the control (inner) core. Carefully pry the control core out of the primary core, and pulling in the direction shown, completely remove it.

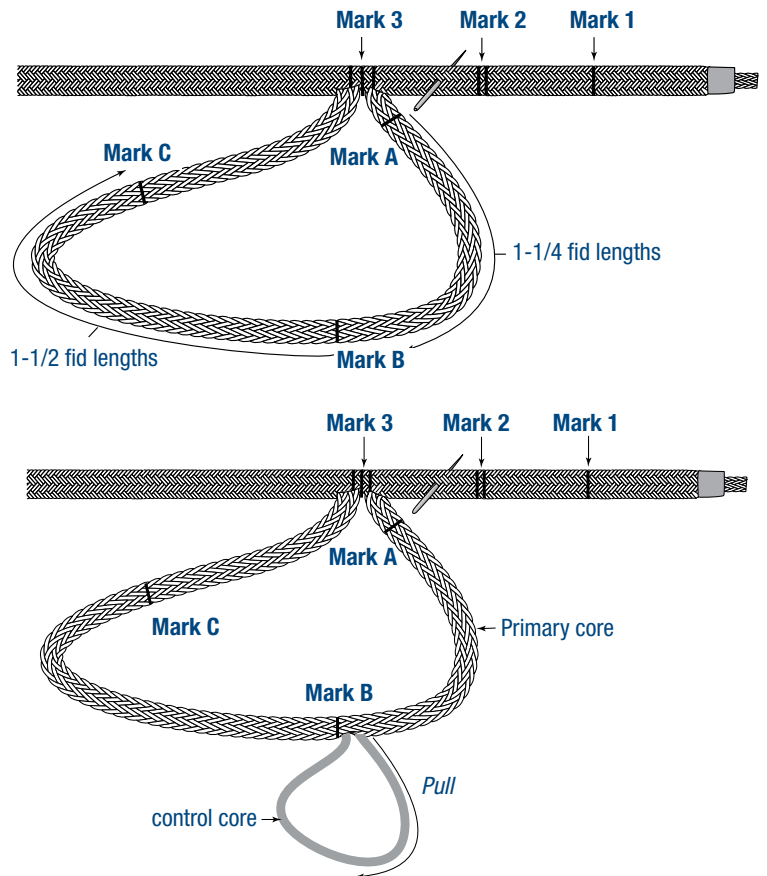



Double Braid Class II Eye Splice for TS-II™ / TS-II Premium™

samson
THE STRONGEST NAME IN ROPE

4B After the control core has been pulled completely free, cut off the excess approximately 1 foot from where it protrudes from the primary core.

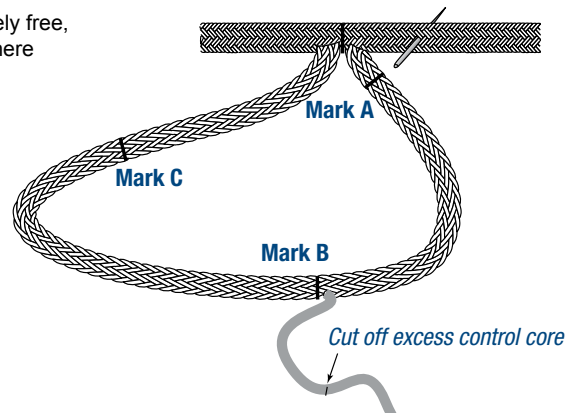

STEP 5 TAPERING THE COVER

From Mark 2 on cover, count 8 picks (pairs of right and left laid strands) in the direction of Mark 1 and make Mark T.

Extract core from cover at Mark T and pull completely free.

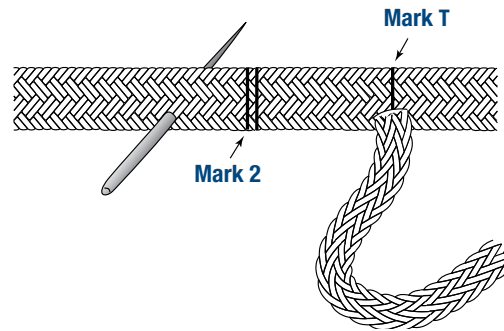
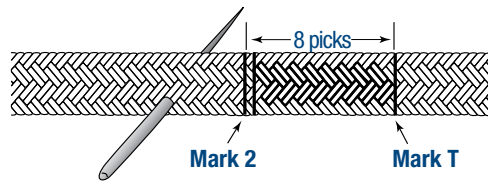

5A Cut cover at Mark 1. Starting at Mark T on the side of the cover opposite from the core extraction point, mark every other right and left laid strand pair for a distance of 5, 6, or 8 pairs, depending on rope diameter (1/2" through 5/8" diameter, mark 5 pairs, 3/4" through 1-1/2" diameter, mark 6 pairs. 1-5/8" diameter and above mark 8 pairs.)

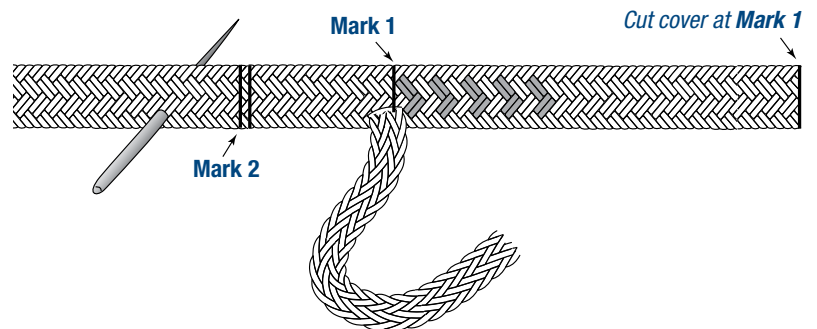

5B Reduce cover tail to 1/2 volume by cutting and removing the marked strand pairs. Milk cover from pin placed between Marks 2 and 3 towards exit point of core tail. Make Mark D on the core at its exit point. From Mark D, measure down the core a distance of 2/3 fid length, and make Mark E.

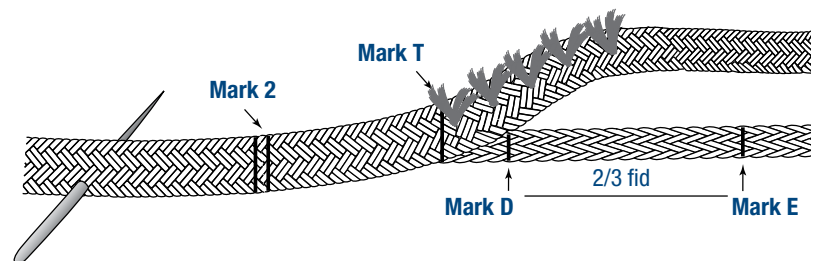



STEP 6 INSERTING COVER INTO CORE

Using a tubular fid, insert 1/2 volume cover tail into core tail at Mark D, and exit at Mark E. Make sure there is no cover slack between the pin and Mark T, then pull cover tail to tighten up cover/core crossover.

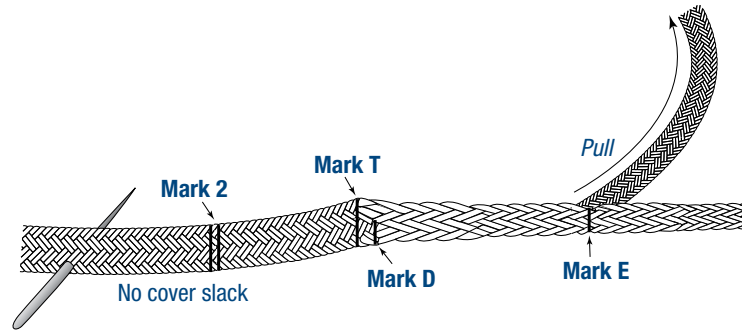

6A Thoroughly milk core tail from Mark D to Mark E. Make a mark on the 1/2 volume cover tail where it exits the core tail. Pull on cover tail to expose several inches. Cut cover tail off at the exit mark and perform angle taper.

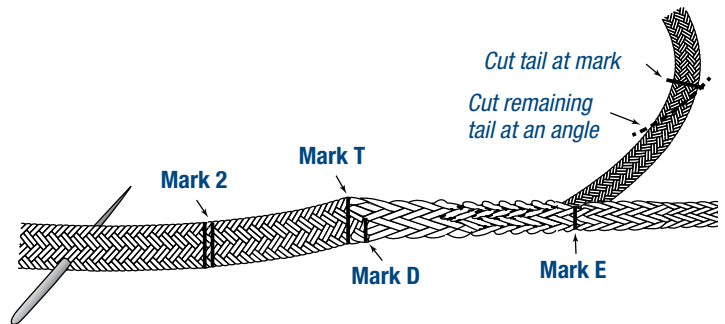

6B Re-milk core tail from Mark D to Mark E. Cover tail should disappear inside core tail. You are now ready to bury the core tail into the core loop.

STEP 7 BURYING CORE TAIL INTO CORE LOOP

Tightly tape the end of the core tail and insert into fid. Secure the core tail to the fid with a wrap of tape.

Note: When splicing thimble eye, slide thimble in place between Marks 2 and 3 before attaching fid.

7A Insert the fid into the core loop at Mark A. By alternately pushing the fid forward and milking the core loop back towards Mark A, feed the fid and core tail through the core loop past Mark B, alongside of the control core and bring out at Mark C.

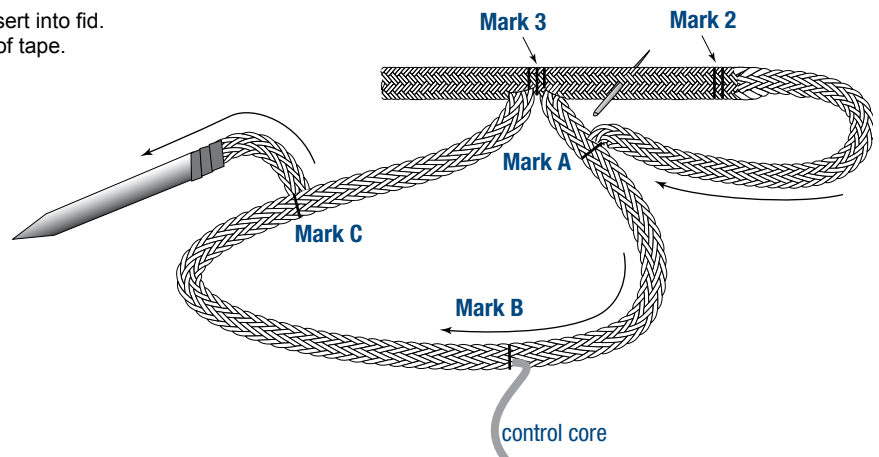

7B Pull core tail through core loop until Mark 2 on cover meets Mark A on core loop. Remove pin between Marks 2 and 3, and place through core loop at junction of Mark 2 and Mark A.

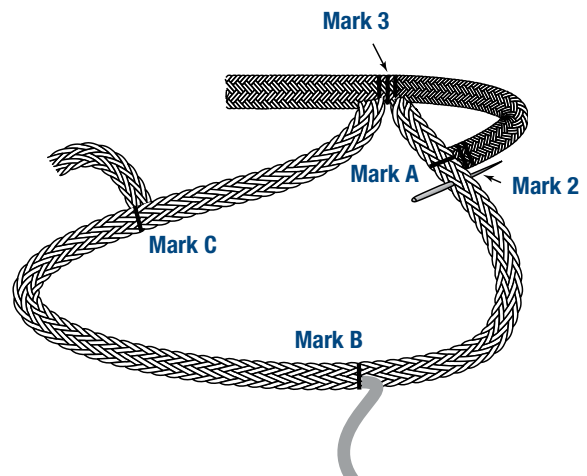



Double Braid Class II Eye Splice for TS-II™ / TS-II Premium™

samson
THE STRONGEST NAME IN ROPE

STEP 8 TAPERING THE CORE

Pull end of core tail to expose approximately 2/3 fid length of core tail. Remove fid and all tape from end of tail. From end of core tail, count 3 strands and mark a right and a left strand. From marked strands, count 4 strands and mark a right and left strand. Alternately mark third right and left strands then 4th right and left strands until a total of 5 right and left pairs have been marked. Taper core by cutting and removing marked strands.

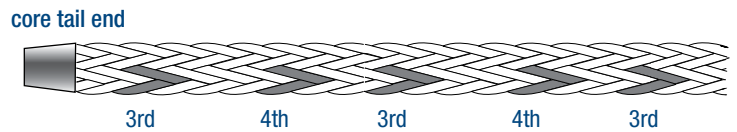

STEP 9 FINISHING THE SPLICE

With rope positioned as shown, milk core loop away from pin, working slack beyond Mark B where control core exits primary core. Hold core loop as shown and pull sharply. This will set the position of the control core and cause the core tail to disappear inside the core loop. Repeat milking and pulling until all slack is removed from core loop.

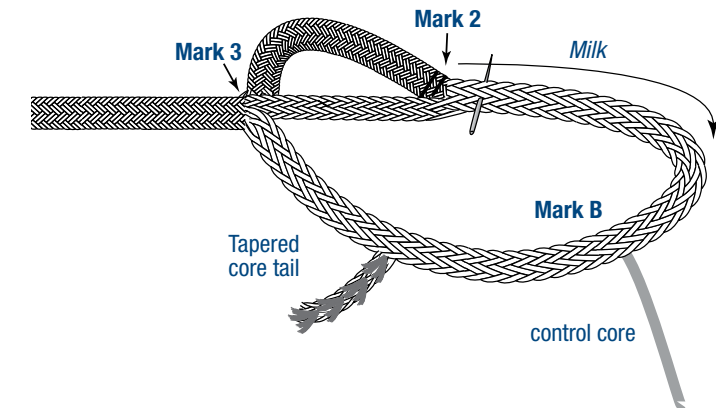

9A Mark control core right where it exits the core loop. Pull control core out slightly, then cut off just short of the mark. Repeat previous step one final time to seat control inside of core loop. Remove the pin.

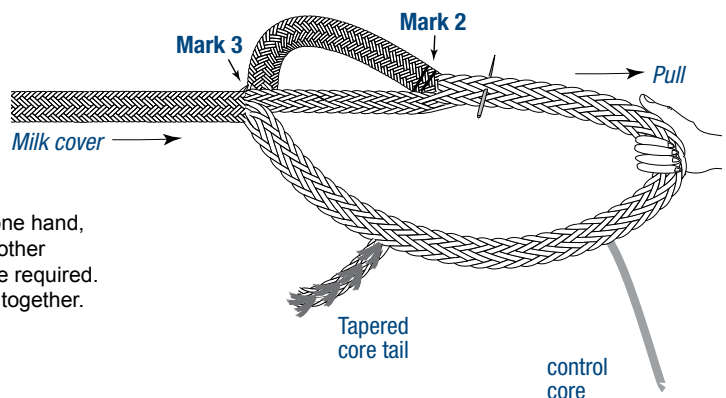

9B Create tension on core loop by pulling on it with one hand, then begin to milk cover up over splice area with other hand. On larger sizes, mechanical tension may be required. Continue cover milking until Marks 2 and 3 come together.

9C After the cover is completely milked and the core loop is fully buried, there may be a small loop of core material protruding from the cover at Mark 3. Milk the cover around the eye towards the core material and pull sharply on eye. Excess core material should disappear inside of eye.

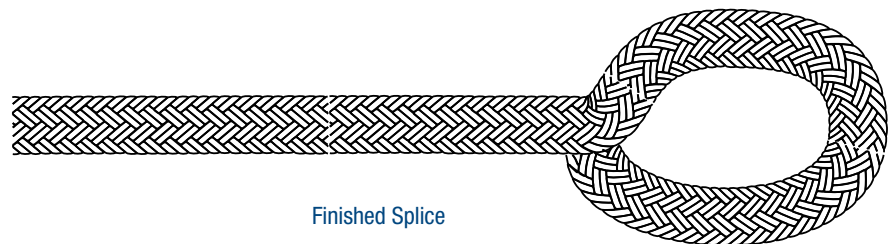

Finished Splice



Double Braid Class II Eye Splice Modified for Turbo-37

samson
THE STRONGEST NAME IN ROPE

STEP 1 MEASURING AND MARKING

From the end of the rope, measure a length that is equal to 33 times the rope diameter (in inches) and make a mark on the cover. This is Mark 1.

Using Mark 1 for reference, form the desired eye size and make Mark 2. Securely tape the cover just beyond Mark 1 and just ahead of Mark 2.

Keep Marks 1 and 2 aligned, measure in the direction shown, a distance of 10 times the rope diameter, and mark the cover on both legs.

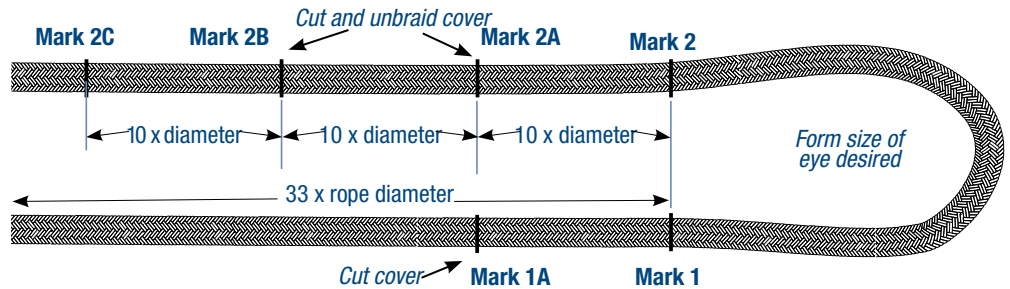

These are Marks 1A and 2A. From 2A measure down standing part 10 times rope diameter and make Mark 2B. From 2B measure down standing part and additional 10 times rope diameter and make Mark 2C.

STEP 2 INSTALLING SPLICE COVER MATERIAL

Using an appropriate sized cover material, slide the cover onto the rope and slide back past Mark 2C (onto the standing part of the rope.) This cover material will later be used to cover the exposed cores in the splice area.

STEP 3 REMOVING COVER

Cut the cover of the rope at Mark 1A and remove. Cut the cover at Marks 2A and 2B and unbraid the cover strands back to Marks 2 and 2C, respectively. Unbraid the section of cover between Marks 1A and 1.

Remove and discard the section of cover between Marks 2A and 2B.

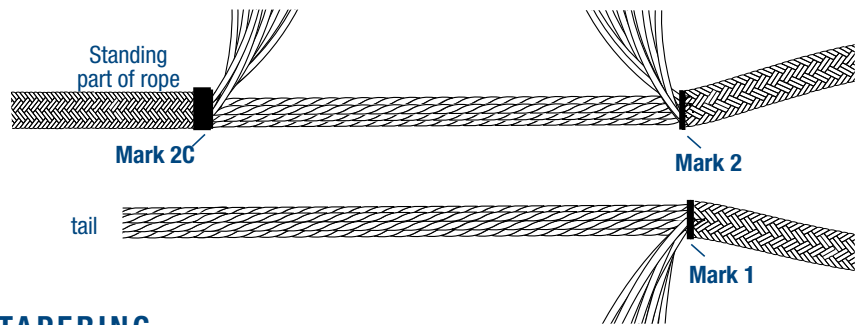

STEP 4 MARKING THE COVER FOR TAPERING

All tucks should be made against the lay (Fig. A). After the 1st tuck, each tuck consists of passing the tail over 1 strand, then under the next strand (Fig. B). When pulling the tail through, pull perpendicular to the direction the rope is lying, and take care not to over tighten the tuck (this will cause unnecessary distortion (Fig. C). As the splice progresses, the tail should gradually spiral around the standing part. To accomplish this, it is necessary to pull the tail underneath the standing part of every 3rd or 4th tuck (Fig. D).

Complete 15 tucks with full volume tail, then remove 1 strand from tail and complete 3 tucks with the remaining 2 strands (Fig. E). Now remove 1 strand and complete 3 tucks with the remaining 1 strand (Fig. F). Tape the tails to the rope.

Figure A

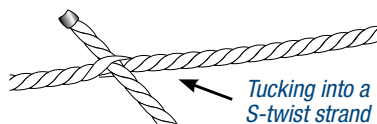

Figure B



Figure C

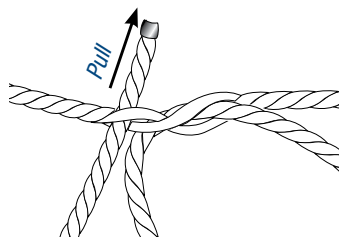

Figure D

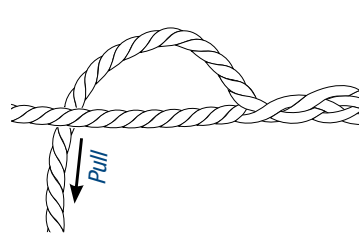
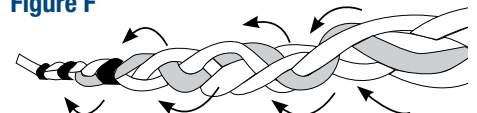

Figure E



Figure F





Double Braid Class II Eye Splice Modified for Turbo-37

samson
THE STRONGEST NAME IN ROPE

STEP 5 SPLICING CENTER CORE

The first part of the splice uses the center core and the center core tail (core #1). Both the center core and the tail should be pulled out between the top 3 cores and the bottom 3 cores. Put the center core tail under the center core so that the 2 sections continue in the line of the 2 legs of the splice. Begin tucking the core tail into the standing part where they intersect.

The cores are arranged parallel within the braided jacket with one core in the center and six cores around it. The cores are numbered in the splicing instructions to help identify which core is used when splicing.

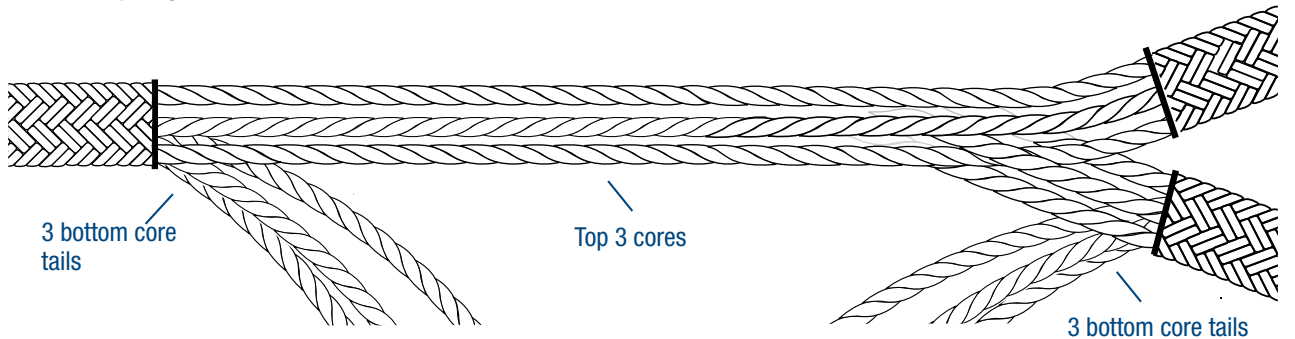
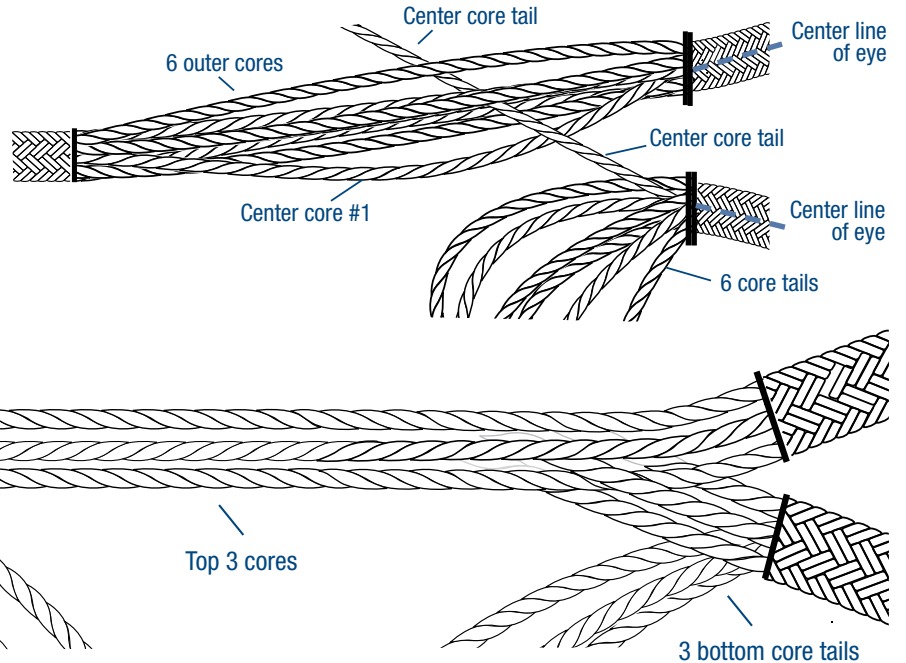
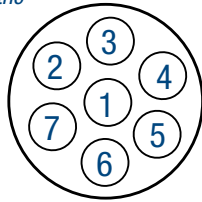

STEP 6 SPLICING TOP 3 CORES

Lay out the top 3 cores and core tails as shown above. Maintain the angle of the legs of the eye splice when positioning the cores and core tails. Pass core tail #4 under cores #4 and #3 and then begin tucking into core #2 where they intersect. Pass core tail #3 over core #4 and begin tucking into core #3. Finally, begin tucking core tail #2 into core #4. When finished, the rope should appear as shown in Fig. G.

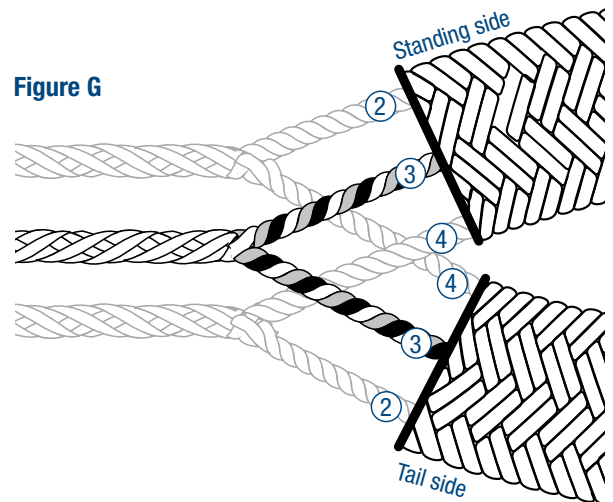



Double Braid Class II Eye Splice Modified for Turbo-37

samson
THE STRONGEST NAME IN ROPE

STEP 7 SPLICING BOTTOM 3 CORES

Turn the rope over and repeat Step 6 using the last 3 cores and core tails. Core tail #5 passes over core #5 and #6 and tucks into core #7. Core tail #6 passes under core #5 and tucks into #6. Core tail #7 tucks directly into core #5 (Fig. H).

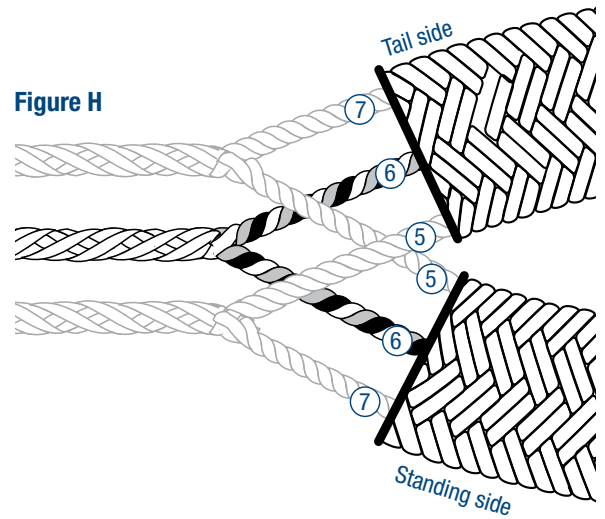

STEP 8 DIVIDING COVER INTO 6 BUNDLES

Put the rope under tension and slide the cover from the base of the splice back up the rope towards the splice area. It will be necessary to unbraided the end of the cover for some length in order to remove all the slack from the braided section. Slide past the braided section as far as possible up past the end of the splice.

Then tightly tape the braided cover at the point where the braid begins to come apart and divide the unbraided cover yarns into 6 separate bundles. Finally divide the unbraided cover yarns from the eye into 6 separate bundles (3 bundles from each leg of the eye.)

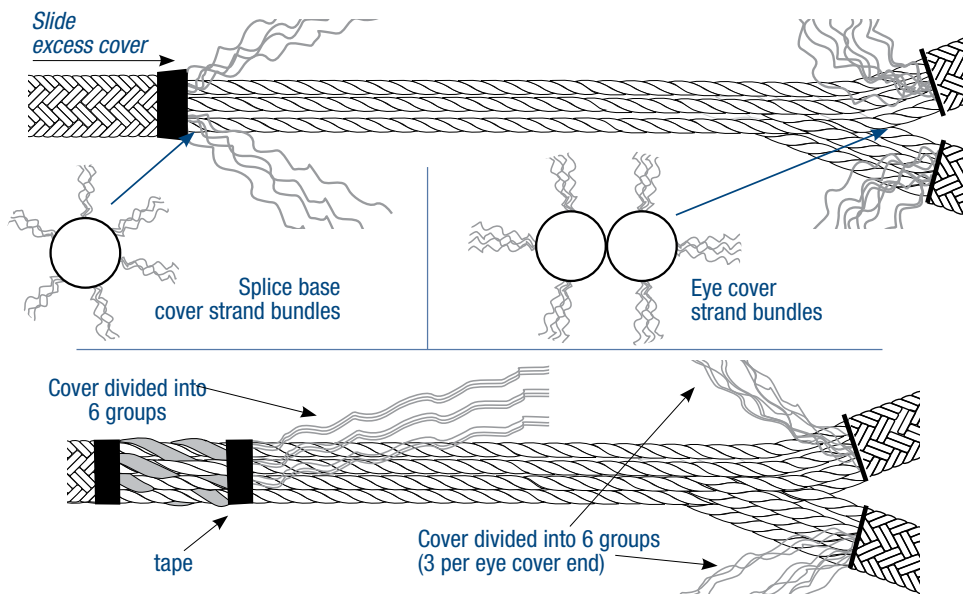

STEP 9 GROUPING AND TUCKING COVER

Starting at the base of the splice, take 1 of the 6 braid bundles, pass it over 1 of the cores and under the very next core (forming a simple tuck similar to that used in splicing 3-strand rope.) When tucking the cover bundle be careful not to go under the core in the center of the rope. Repeat this procedure with each of the 6 cover bundles. The direction of the tucks should be as shown.

When all 6 bundles have been tucked once, tightly tape around the rope at the point where the tucks occur. Repeat this procedure until a minimum of 3 complete tucks have been made with all 6 cover bundles. Additional tucks can be made if there is sufficient length left. When the last set of tucks has been made and taped, cut off the excess cover yarn bundles flush with the last taped section.

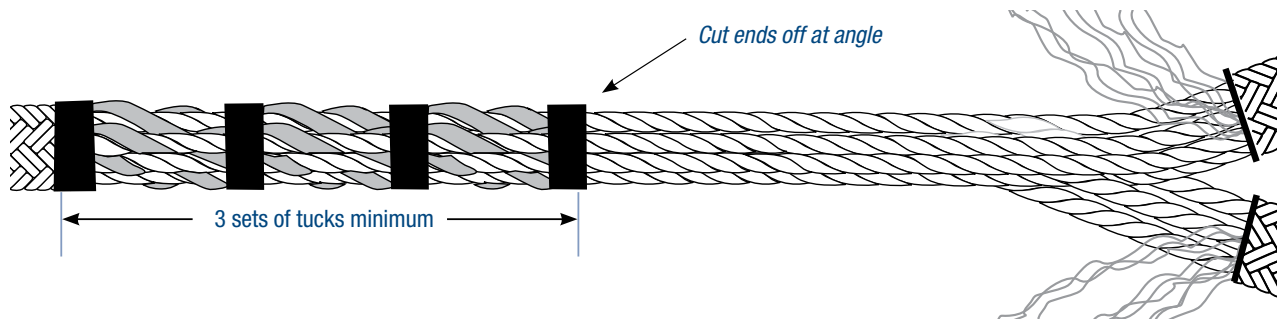



Double Braid Class II Eye Splice Modified for Turbo-37

samson
THE STRONGEST NAME IN ROPE

STEP 10 TUCKING EYE COVER BUNDLES

Next, tuck the 6 cover braid yarn bundles at the base of the eye. With the eye laying flat (as shown in Fig. I) take bundle closest to the throat of the eye (bundle #1) and pass it under core A. Take the next cover yarn bundle (#2) and pass it under core B. Take core bundle #3 and pass it under core C.

Turn the rope over and continue this process with the 3 remaining cover yarn bundles (Fig. J). The direction of the tucks should be as shown. Tape around the rope at the point where the tucks occur. Repeat this procedure until a minimum of 3 tucks have been completed. When the last set of tucks has been made and taped, cut off excess cover yarn bundles flush with the last taped section.

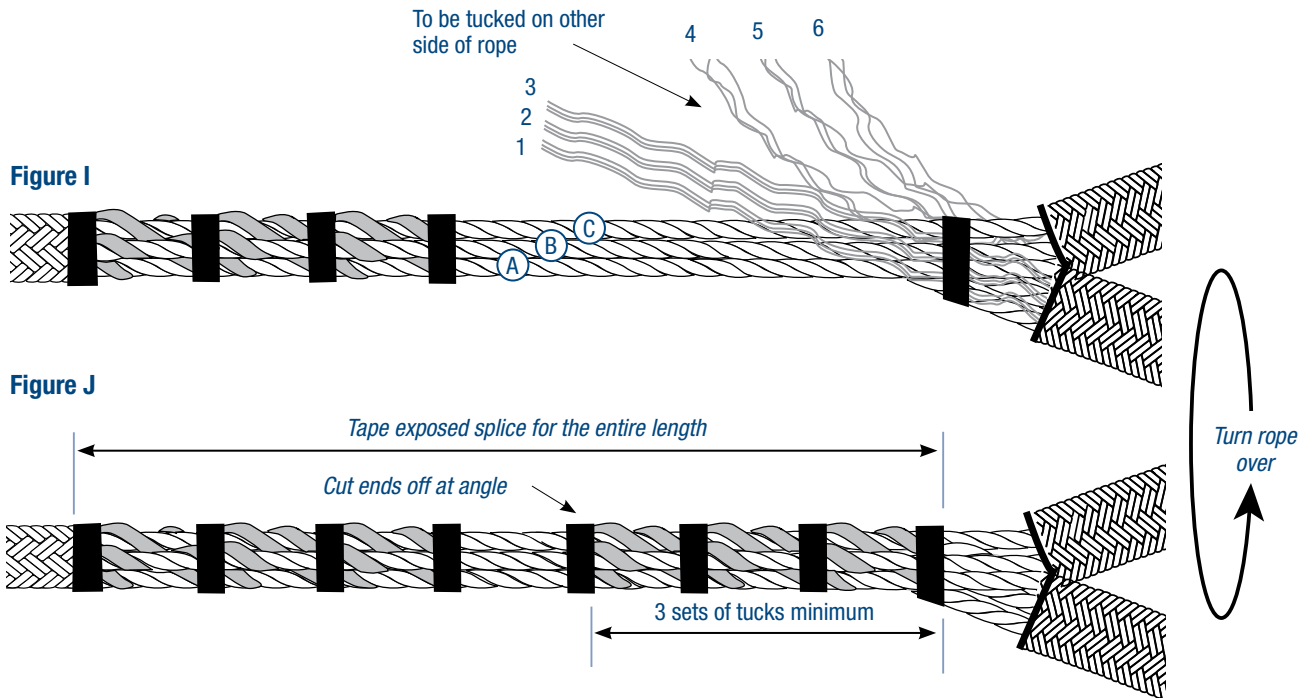

STEP 11 FINISHING THE SPLICE

Slide the cover material (which was put on the rope in Step 3) up over the exposed cores. At the eye-end of the splice, separate the strands of the cover material into 4 equal size bundles (2 on the top of the rope and 2 on the bottom.)

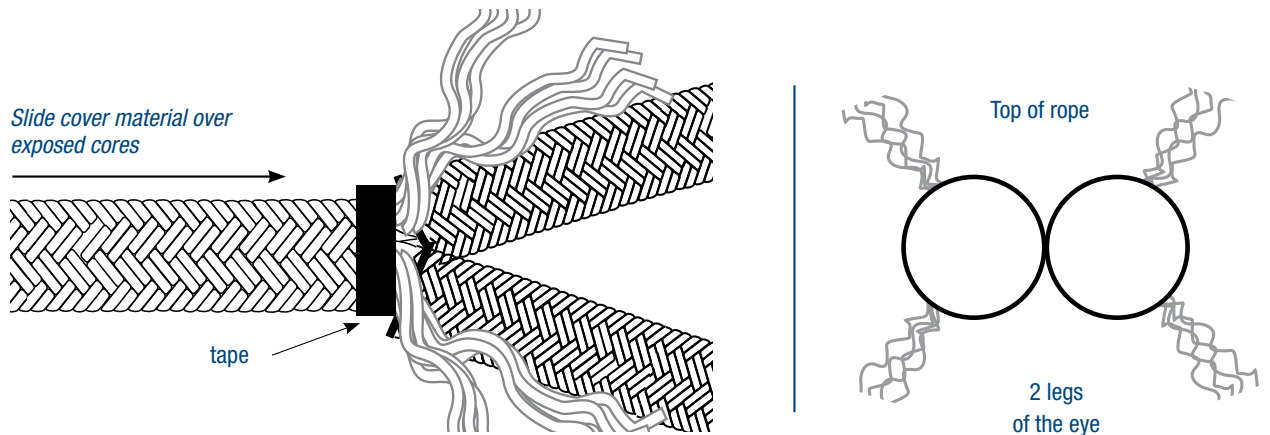



Double Braid Class II Eye Splice Modified for Turbo-37

samson
THE STRONGEST NAME IN ROPE

11A One at a time, pull the 2 strand bundles through the throat of the eye. Pull the bundles tight and tape them down on the back side of the rope. Turn the rope over and repeat with the remaining 2 bundles.

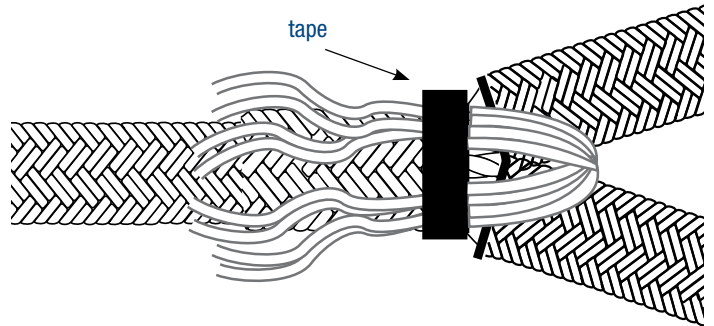

11B Seize over the area (from the throat of the eye down the standing part) for a distance of 2 times rope diameter (in inches) using nylon seizing material.

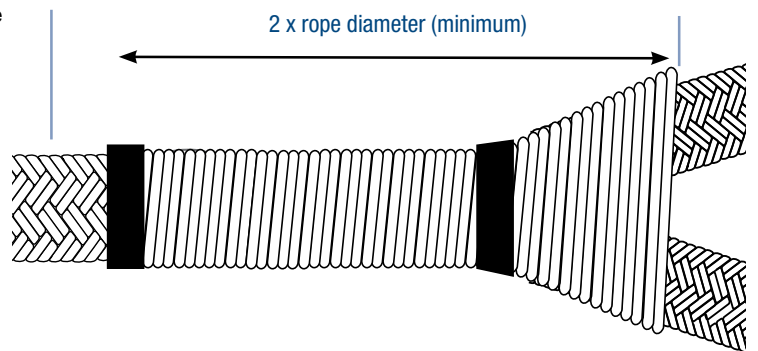

11C Milk all of the excess cover slack from the cover material down towards the standing part of line. Tightly tape the cover to the rope approximately equal to rope diameter (in inches) back from the end of the cover. Unbraid the cover strands from the tape to the end.

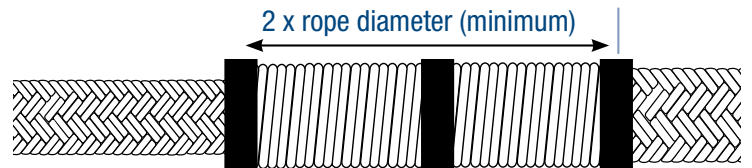

11D Seize over the area for a distance of 2 times rope diameter (in inches) with nylon seizing material. After seizing both ends of the cover material, apply a two-part urethane coating over the seized areas as shown, extending the urethane coating 1/2 the length of the seized area on both sides of the seizing.

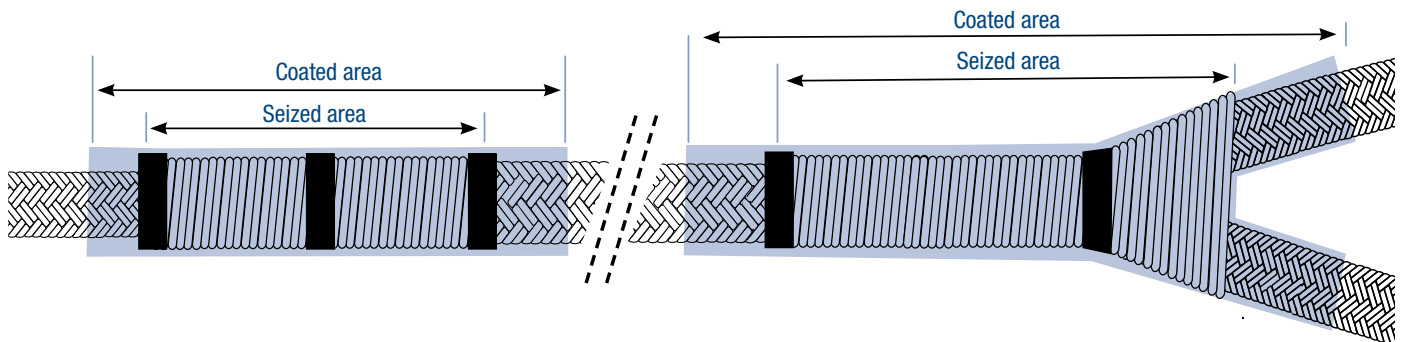



Double Braid Class II Eye Splice

Class II (core-dependent) double braids are made in whole or part from any of the following high modulus fibers: Dyneema®, Vectran®, Technora®, and Zylon®.

The eye splice is used to place a permanent loop in the end of a rope, generally for attachment purposes to a fixed point. An eye is also used to form the rope around a thimble, which is used to protect the rope, especially when it is to be attached to a shackle, chain, or wire rope.

The following procedure is intended to preserve the strength of double braided rope constructions where the rope's core is the primary strength member.

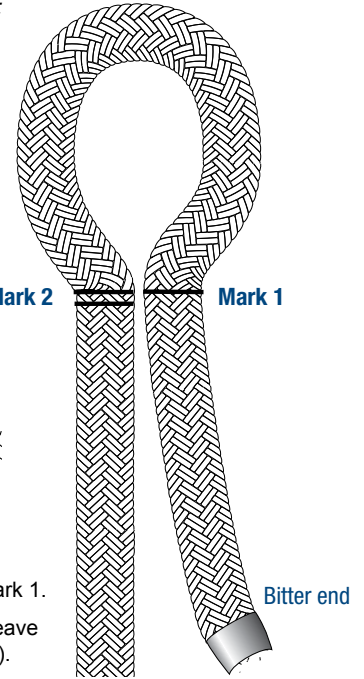

STEP 1 MARKING THE COVER

1A

Measure 2 tubular fid lengths back from bitter end: Place Mark 1 on cover and on core.
(For AmSteel® II Plus: the required bury length is 3 fids.)

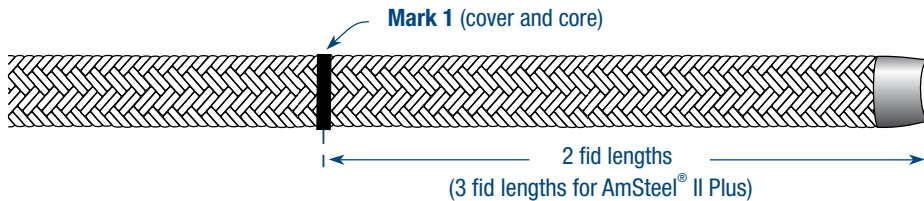

Measure eye size back from Mark 1 and place Mark 2 on both the cover and core, as done with Mark 1.

When splicing on a thimble with ears, slide thimble on and position between Mark 1 and Mark 2. Leave in place and continue with the splice. Thimble must be positioned between "X" points (see Step 1B).

1B

From Mark 1 on the cover, going towards the end of the rope, measure Z length 1 and make a mark at extraction Point X1.

From Mark 2 on the cover, going towards the end of the rope, measure Z length 2 and make a mark at extraction Point X2.

LENGTH OF Z SECTION BASED ON SIZE OF ROPE IS AS FOLLOWS:

AmSteel® II

Size (Dia.)	1/4"	5/16"	3/8"	7/16"	1/2"	9/16"	5/8"	3/4"	7/8"	1"	1-1/8"	1-1/4"	1-5/16"	1-1/2"
Z Length 1	5-1/2"	5-1/2"	5-1/2"	5-1/2"	5-1/2"	6-1/2"	7-1/2"	8"	10-1/2"	12"	13-1/2"	14"	15"	15"
Z Length 2	4-1/2"	4-1/2"	4-1/2"	4-1/2"	4-1/2"	5-1/2"	6-1/2"	7"	9-1/2"	11"	12-1/2"	13"	14"	14"

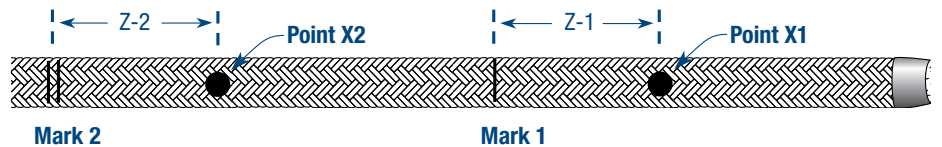

1C

Put a slipknot or pin in the rope 6 fid lengths back from Mark 2.
(8 fid lengths for AmSteel® II Plus.)

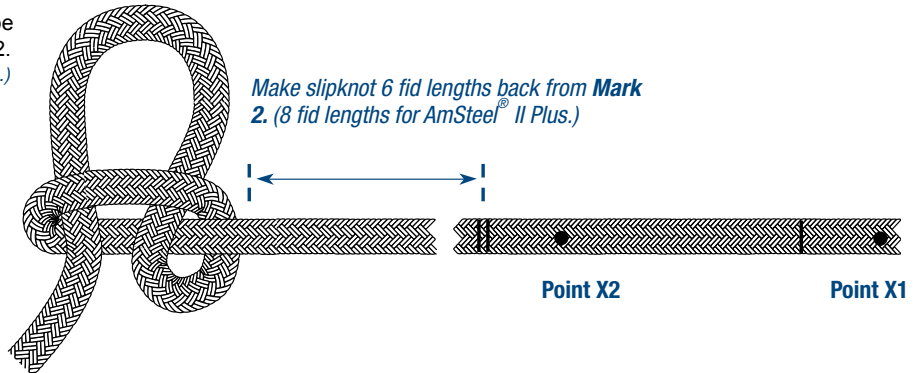

Make slipknot 6 fid lengths back from Mark 2. (8 fid lengths for AmSteel® II Plus.)

STEP 2 EXTRACTING THE CORE

2

Extract core at Point X1 nearest end of rope. Put an overhand knot in core at the point where it comes out of the cover.

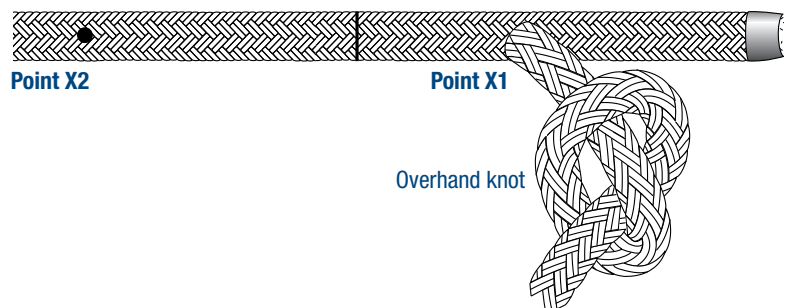



Double Braid Class II Eye Splice

2A Now extract core at Point X2 in the form of a loop. Expose 2-1/2 fids from Mark 2 and make Mark 3. (3-1/2 fids for AmSteel® II Plus.)

When using thimble with ears, move rope around thimble to expose second extraction point.

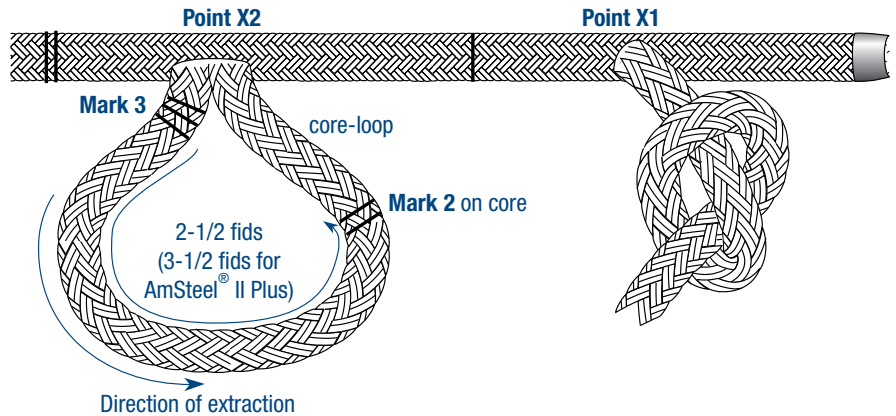

STEP 3 INSERTING CORE INTO CORE

Remove knot in core and insert core tail into core loop at Mark 2 for 2-1/2 fid lengths and beyond Mark 3. Pull core tail through until Mark 1 on core meets Mark 2 on core loop. Keep these marks together by inserting an awl or a pusher through both marks.

(3-1/2 fids for AmSteel® II Plus.)
From the end of the core go back 3/4 of a fid, mark every other right and left strand for 3 strands.

Pull every marked strand out of line and cut (tape at end can cause resistance and may have to be removed in order to pull out cut strands.) Tapered end will now have only 6 strands remaining. Tape tapered tail tightly to keep from unbraiding.

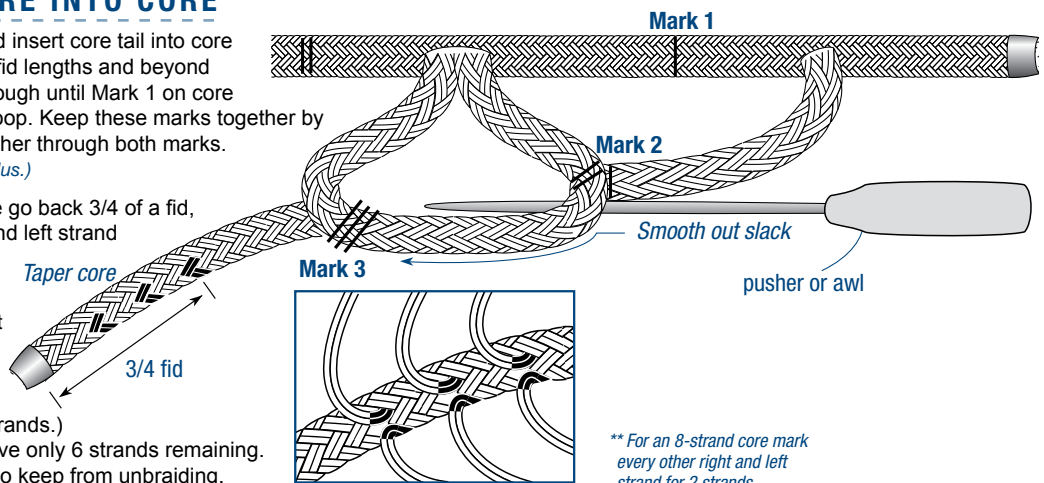

** For an 8-strand core mark every other right and left strand for 2 strands.

STEP 4 SMOOTHING COVER

Milk up cover completely away from slipknot and toward eye. This should bring cover up to Mark 1 and Mark 2 on core (a little over is acceptable.)

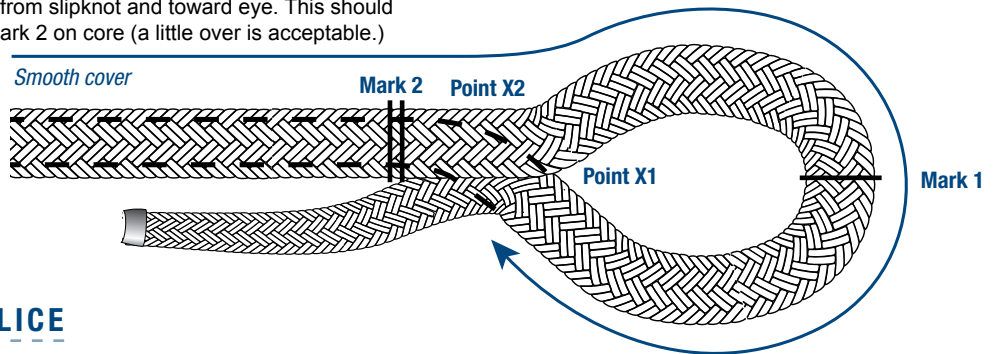

STEP 5 FINISHING THE SPLICE

Bring cover-tail down on side of rope (minimum 2 times rope circumference in inches) and lock stitch (or tape) excess cover to rope. After lock stitching, excess cover should be whipped to the neck of the rope with appropriate whipping twine. Start whipping at the throat of the eye moving toward tail using Whipping Method 2.

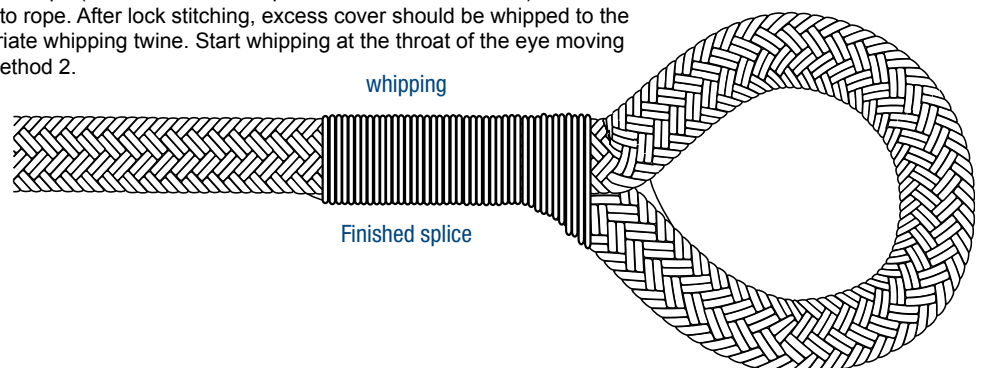

Whipping Method I and Seizing Method II

Choosing twines for whipping:

In general, braided nylon twine is preferred for whipping. Polyester twines, or twisted twines in either polyester or nylon, can also be used.

For double braids the twine used should be approximately twice the diameter of the strands in the cover.

Whip or seize the end of the spliced area with whipping twine for extra security and a professional touch. Keeping tension on rope while wrapping results in tighter whipping.

STEP 1 Form loop along the rope with whipping twine and wrap end around the back.



Seizing Method II

STEP 1
Attach twine to netting needle.



STEP 2
Tape the free end of the twine to the opposite side of the area to be whipped.

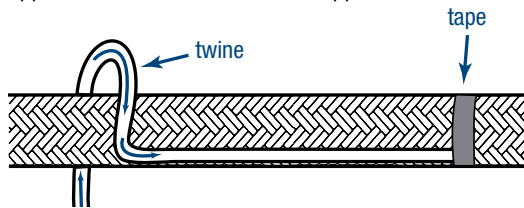

STEP 3
Start seizing. Wrap the needle around the circumference of the rope 1 complete turn. Pass the netting needle under the complete wrap left to right. Pull the loop tight. Pull the needle up maintaining tension on the completed half hitch and then quickly pull back down to lock the half hitch in place.

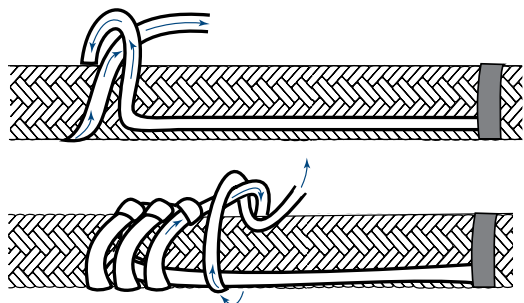

STEP 7
Pull the loop through the whipped area. This should place the remaining whipping twine under the whipped area.



STEP 2 Continue wrapping at least 1 rope diameter in length.

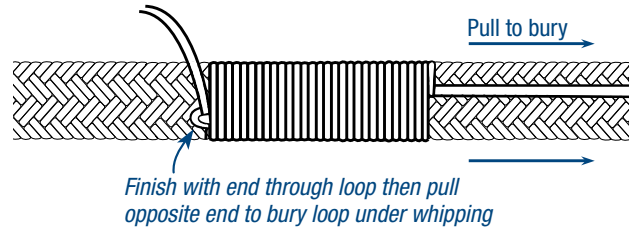

STEP 3 Cut both ends close to whipping.

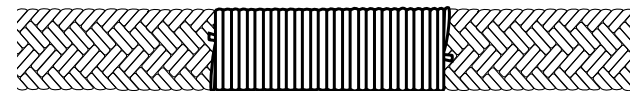

STEP 4
Continue with this procedure until the whipped area is approximately 1/2 of the desired length, then cut off the taped end near the last wrap.

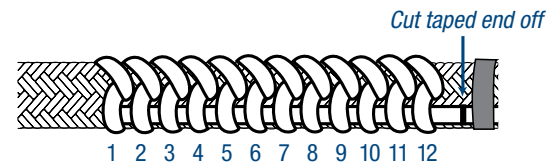

STEP 5
Using some spare twine, tape a loop that covers the length of the intended whipping distance, letting the 2 free ends of the looped twine lay over the completed whipping. Tape the free ends of the loop past the already whipped area.

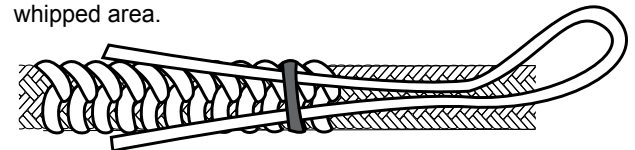

STEP 6
Continue whipping for the desired total length over the top of the looped twine. After whipping is complete, pass the exposed whipping twine through the loop. Remove the tape on the looped twine and pull the ends to draw the loop under the whipping. Cut off any excess twine.

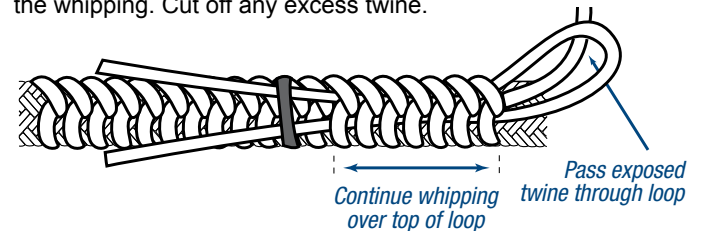

Double Braid Class II Stripping Cover

Class II core-dependent double braids are made in whole or part from any of the following high modulus fibers: Dyneema®, Vectran®, Technora®, and Zylon®.

Many high-performance sailors like to strip the cover from the core to save weight aloft for halyard applications. In simple terms, you want to strip the cover from the core up to the area of the stoppers, cleats and winches. Leave the cover on the core wherever you have to cleat or winch the rope. The following is a simple, step-by-step method of stripping the cover and finishing the transition area where the cover ends and the core continues.

STEP 1 MARKING AND KNOTTING

Tie a slipknot with a loop about 5 feet back from the dot on the cover.

Mark a dot on the cover in the area where you want the core to be exposed.

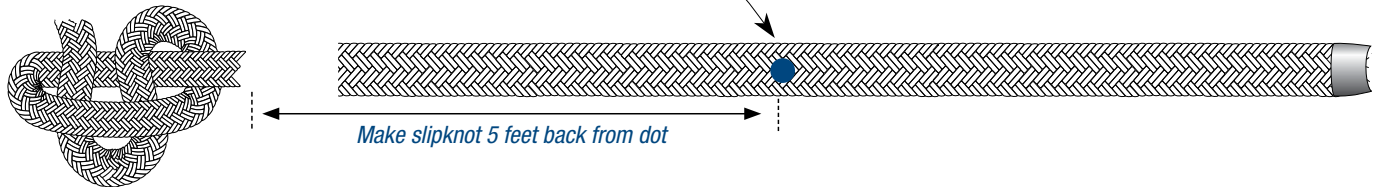

STEP 2 EXTRACTING THE CORE

Bend rope sharply at extraction point. With a pusher or any sharp tool such as an ice pick, awl, or marlin spike, spread the cover strands to expose core. First pry, then pull the core completely out of cover.

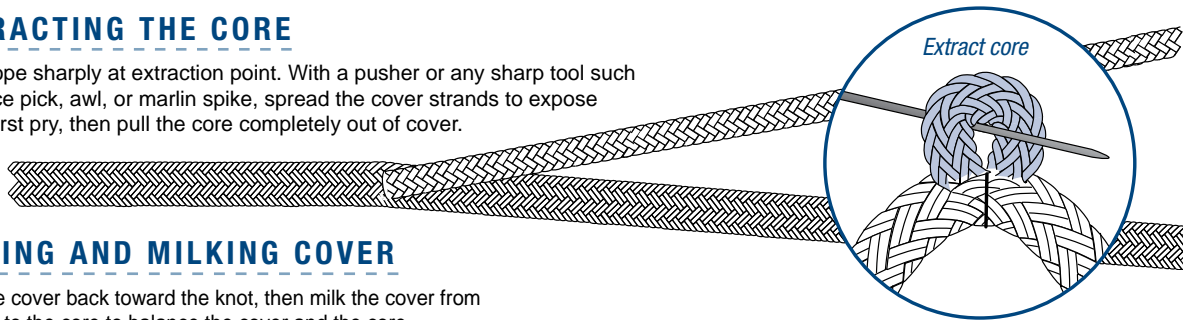

STEP 3 SLIDING AND MILKING COVER

Slide the cover back toward the knot, then milk the cover from the knot to the core to balance the cover and the core.

STEP 4 LOCK STITCHING

Lock stitch the cover to the core from the dot back for about 3 complete passes. (See page 3 for tips on lock stitching.)

Lock stitch the cover to the core for 3 complete passes back from the extraction point

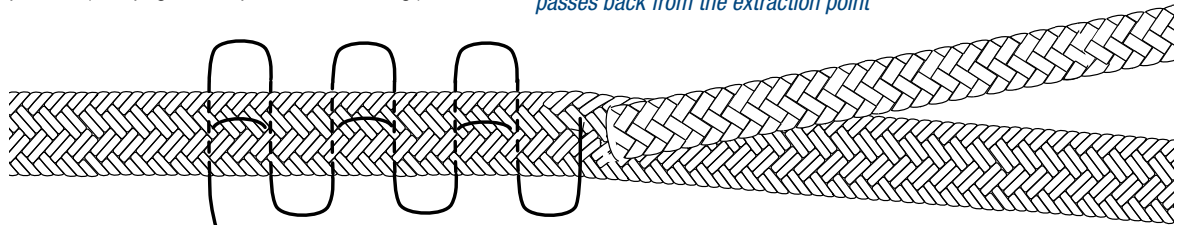

STEP 5 MEASURING AND MARKING COVER

From the point of the lock stitch toward the end of the cover material, measure 6 inches and mark. This will be Mark 1 on the cover.

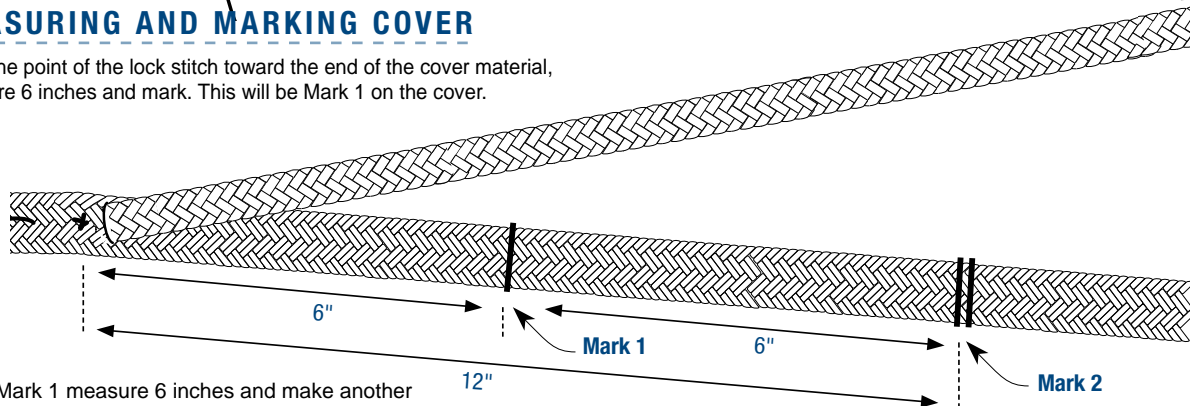

STEP 6

From Mark 1 measure 6 inches and make another mark. This will be Mark 2 on the cover. Mark 2 should now be about 12 inches from the lock stitch.



Double Braid Class II Stripping Cover

STEP 7 REMOVING COVER

Cut off the cover at Mark 2 and discard the rest of the cover material.

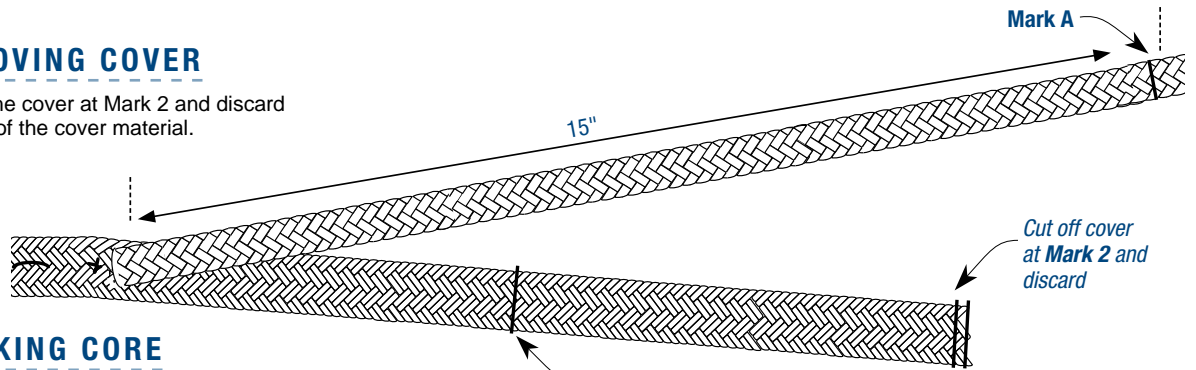

STEP 8 MARKING CORE

From the front of the lock stitch toward the end of the exposed core, measure 15 inches and put a mark on the core. This will be Mark A.

STEP 9 COVER INTO CORE

Insert a splicing fid with the cover into the core as close to the lock stitch as possible. Continue pushing the fid through the center of the core and extract the fid and cover at Mark A on the core.

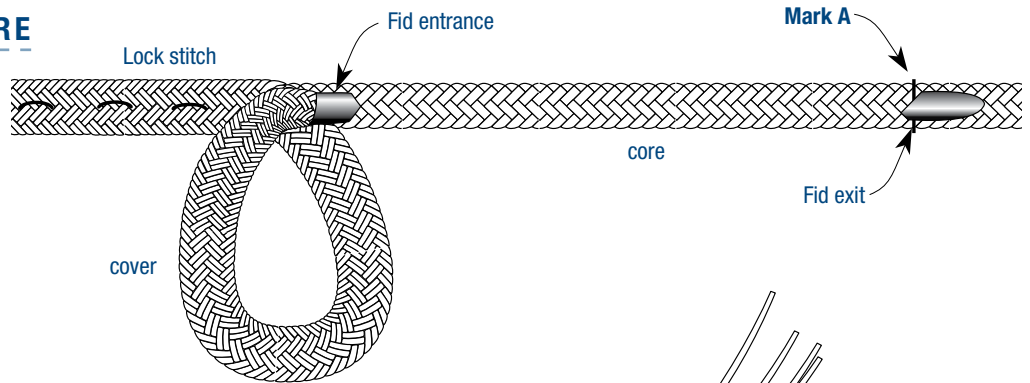

STEP 10 UNBRAIDING COVER

Pull the cover out of the core until Mark 1 is exposed. Unbraid the cover from the end back to Mark 1. Angle-cut the strands from Mark 1 to the end of the cover to perform a taper.

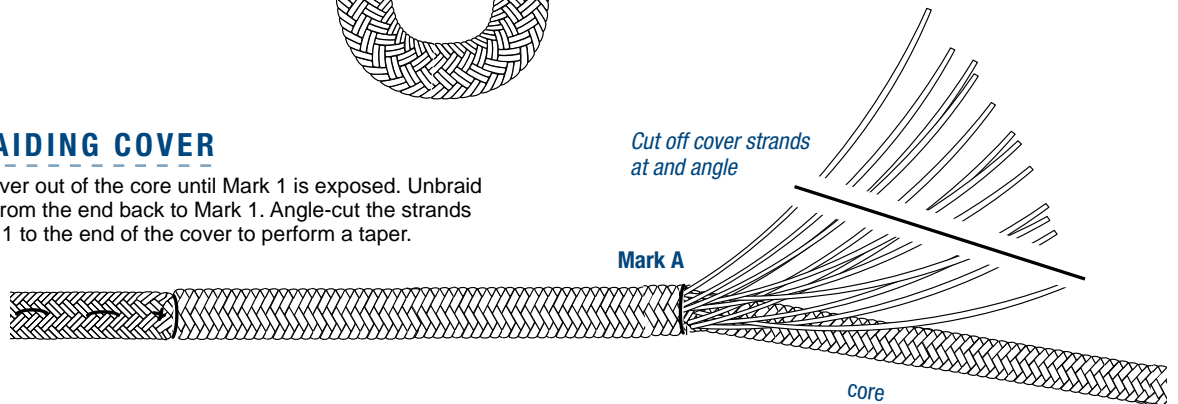

STEP 11 MILKING THE CORE

At the point of cover insertion into the core, milk the core down toward the end of the cover. This will cause the cover to disappear into the core.

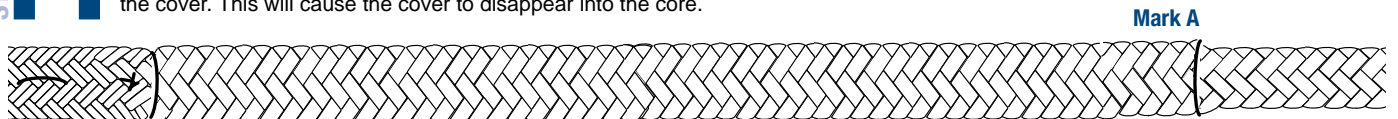

STEP 12 WHIPPING

Whip the area where the cover is inserted into the core, to finish. (See pages 3-4 for tips on whipping.)

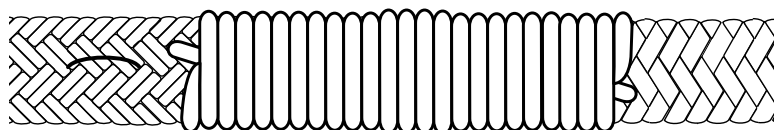



Lock Stitching Procedure Whipping Method I

STEP 1

Pass stitching twine through spliced area near throat of eye as shown.

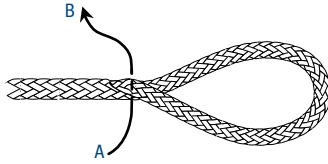

STEP 2

Reinsert twine through the rope. The twine should cover 2 strands from the exit point. Pull the twine snug, but not tight.

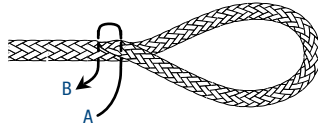

STEP 3

Continue to reinsert as shown until you have at least 3 complete stitches on each side of the rope. Each stitch should cross over 2 strands in the rope.

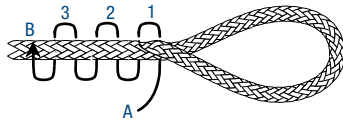

STEP 4

After completing Step 3, rotate spliced part of rope 90° and reinsert end A into spliced area in the same fashion as in Steps 1, 2 and 3. The splice will now be stitched on 2 planes perpendicular to each other. Make sure you do not pull the stitching too tight.

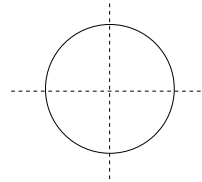

STEP 5

After stitching at least 3 complete stitches as in Step 3, extract both ends of the twine together through the same opening in the braid. Tie them together with a square knot and reinsert back into braid. For double braids, re-insert the knot between the cover and core.

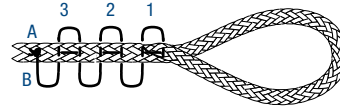

Whipping Finished Splice Method I

Choosing twines for whipping:

In general, braided nylon twine is preferred for whipping. Polyester twines, or twisted twines in either polyester or nylon, can also be used.

For double braids the twine used should be approximately twice the diameter of the strands in the cover.

Whip or seize the end of the spliced area with whipping twine for extra security and a professional touch. Keeping tension on rope while wrapping results in tighter whipping.

STEP 1

Form loop along the rope with whipping twine and wrap end around the back.

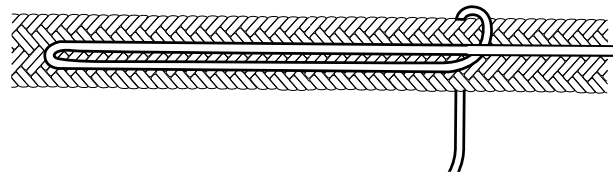

STEP 2

Continue wrapping at least 1 rope diameter in length.

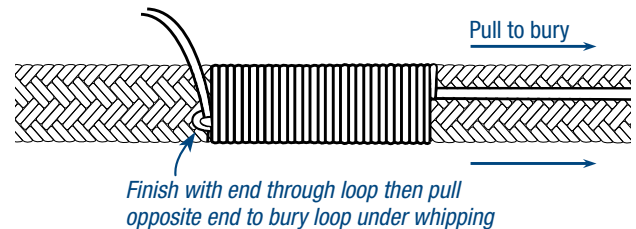

STEP 3

Cut both ends close to whipping.

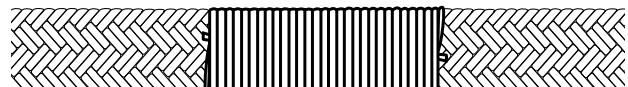

Seizing Method II

STEP 1

Attach twine to netting needle.

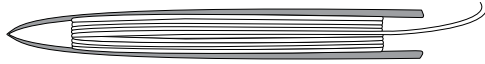

STEP 2

Tape the free end of the twine to the opposite side of the area to be whipped.

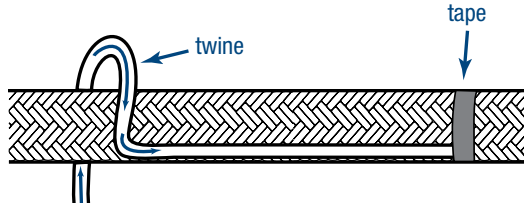

STEP 3

Start seizing. Wrap the needle around the circumference of the rope 1 complete turn. Pass the netting needle under the complete wrap left to right. Pull the loop tight. Pull the needle up maintaining tension on the completed half hitch and then quickly pull back down to lock the half hitch in place.

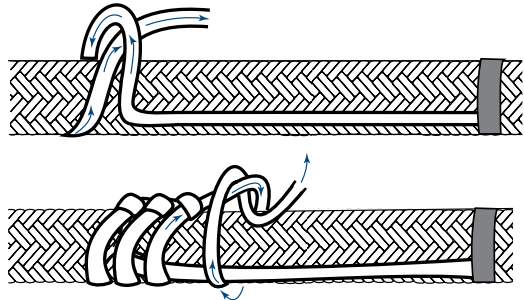

STEP 7

Pull the loop through the whipped area. This should place the remaining whipping twine under the whipped area.



STEP 4

Continue with this procedure until the whipped area is approximately 1/2 of the desired length, then cut off the taped end near the last wrap.

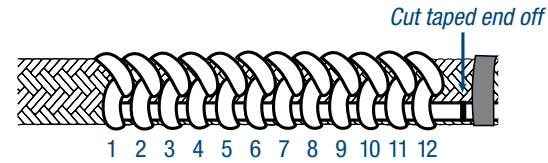

STEP 5

Using some spare twine, tape a loop that covers the length of the intended whipping distance, letting the 2 free ends of the looped twine lay over the completed whipping. Tape the free ends of the loop past the already whipped area.

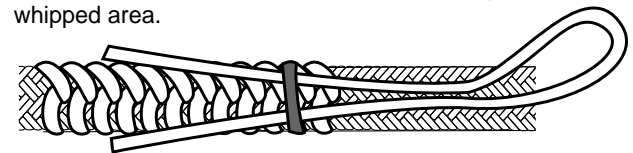

STEP 6

Continue whipping for the desired total length over the top of the looped twine. After whipping is complete, pass the exposed whipping twine through the loop. Remove the tape on the looped twine and pull the ends to draw the loop under the whipping. Cut off any excess twine.

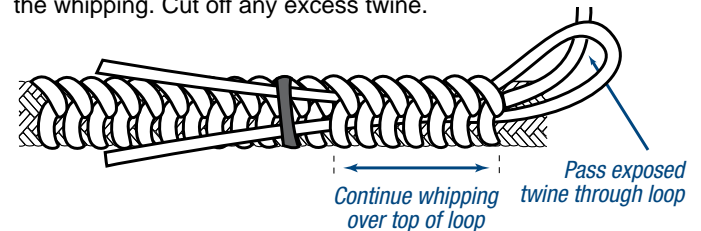



Special Tips: Splicing Double Braid Rope

SPLICE WITH THIMBLE

Follow Step 1 of the Eye Splice Double Braid Class I for determining the correct eye size. When burying exposed core, as in Step 8, bury to crossover, then insert thimble into eye before milking cover all the way. If using a thimble with ears, before inserting cover into core, as in Step 5, insert core through the rings (dog ears) and slide thimble beyond Mark 3. Proceed to make the splice according to instructions.

Note: Before final burying, slide thimble around to cover side of eye. To secure finished eye tightly around thimble, either whip throat or dip the eye in hot water for several minutes. Hot water will shrink the eye tightly around thimble for nylon and polyester fiber ropes.



SPLICING ROPES 3" DIAMETER OR LARGER

Before splicing rope, measure back 8 fids and insert a large fid through the rope to anchor the core and cover together. Use a milking strap to milk slack of cover toward end of rope. A milking strap is a smaller diameter rope that is cinched around the rope to create more seizing power than a human hand can apply. It helps to pull the milking strap with mechanical means (a winch or come-along.) Cut off any excess cover.

Milking the cover is a crucial step and will be done several times during this splice. The milking process aligns the core and cover braid angles and allows them to more effectively share the load when the rope is in use. It is best done with a milking strap for ropes 3" diameter or larger.

After milking, check for cover slack. If cover slack remains, repeat milking process until slack is gone.



MINIMUM LENGTHS

Minimum eye-and-eye sling length with Class I Double Braid is 5 fid lengths from extraction Mark X to extraction Mark X, regardless of rope diameter. The size of eye does not affect the minimum length.



Example: How to make an Eye-and-Eye Sling
10' long overall with two 6" eyes:



Measure and cut a length:

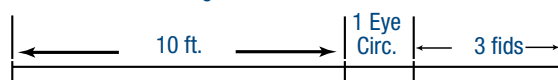

END-FOR-END SPLICE

Minimum endless loop (Grommet) with Class I Double Braid is 10 fid lengths between extraction Mark X to extraction Mark X, regardless of rope diameter.

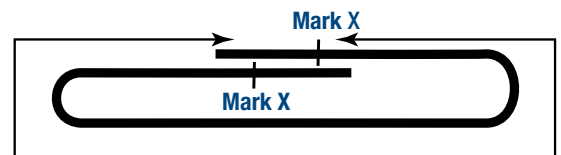

Exact overall lengths with endless loops are determined by allowing for extra rope consumed in making the End-for-End Splice. The length of extra rope is equal to 4 fid lengths.

Example: To make an endless loop 10' overall:

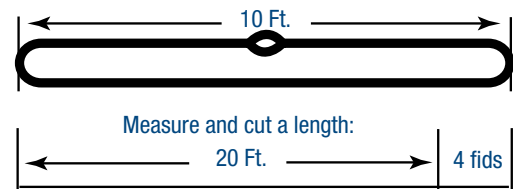



Special Tips: Splicing Used Double Braid

Splicing used rope can be made easier by first establishing the rope's condition. Natural shrinkage may have occurred, caused by water and heat. Sometimes the cover yarns have been braided. By using the technique outlined in the Used Rope Eye Splice for Class I Double Braids, along with the following tips, you can splice used braided rope more easily and with better results.

TIP 1

Before you begin, soak the section of rope to be spliced in water for several minutes — this lubricates and loosens fibers.

TIP 2

After marking cover (as shown in Step 2 of the splicing instruction) untape end of rope, grasp end of core, and slide back cover to pull out core. This loosens and bunches up cover strands in the area of Point X making it easier to open up cover strands for extraction. Carefully loosen 3–4 strand pairs at Point X to assure a large and flexible hole for extraction (Fig. A).

Figure A

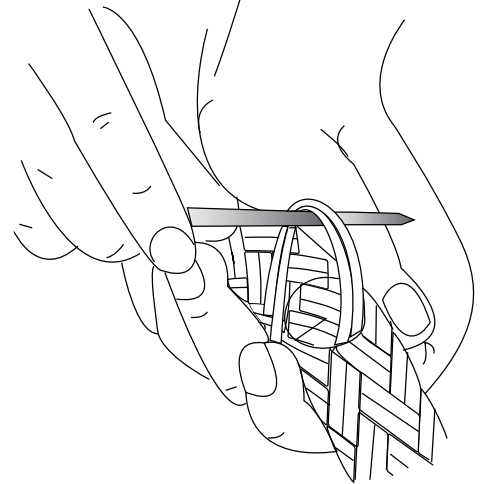

TIP 3

The use of a shock cord in a rolling hitch around the cover is useful to make final burying easier and more complete. Pull on the hitch toward the eye until all cover slack is removed (Fig. B).

Figure B

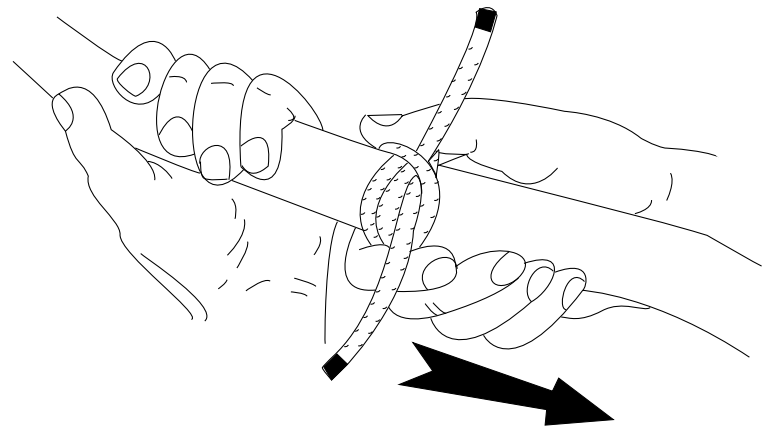

Lock Stitching Procedure



STEP 1

Pass stitching twine through spliced area near throat of eye as shown.

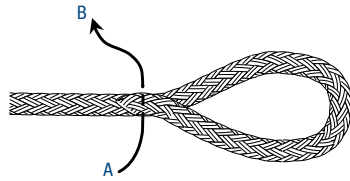

STEP 2

Reinsert twine through the rope. The twine should cover 2 strands from the exit point. Pull the twine snug, but not tight.



STEP 3

Continue to reinsert as shown until you have at least 3 complete stitches on each side of the rope. Each stitch should cross over 2 strands in the rope.

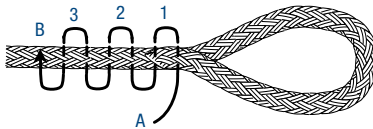

STEP 4

Rotate spliced part of rope 90° and reinsert end A into spliced area in the same fashion as in Steps 1, 2 and 3. The splice will now be stitched on 2 planes perpendicular to each other. Make sure you do not pull the stitching too tight.

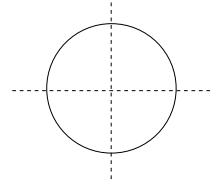

STEP 5

After stitching at least 3 complete stitches as in Step 3, extract both ends of the twine together through the same opening in the braid. Tie them together with a square knot and reinsert back into braid. For double braids, re-insert the knot between the cover and core.

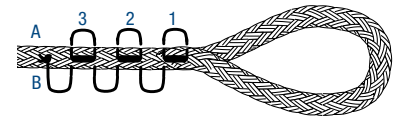

Twines for lock stitching:

In general, braided nylon twine is preferred for lock stitching. Polyester twines, or twisted twines in either polyester or nylon, can also be used. The twine should be approximately the same diameter as 1 strand in the rope. If the rope or the cover of the rope is made up of pairs of strands rather than a single strand, the twine should be about the same diameter as these 2 strands together. To check for correct twine size, lay the twine over the strands in the rope — if it covers the width of the strand(s), it is the right size.

Whipping Method I

Choosing twines for whipping:

In general, braided nylon twine is preferred for whipping. Polyester twines, or twisted twines in either polyester or nylon, can also be used.

For double braids the twine used should be approximately twice the diameter of the strands in the cover.

Whip the end of the spliced area with whipping twine for extra security and a professional touch. Keeping tension on rope while wrapping results in tighter whipping.

STEP 1 Form loop along the rope with whipping twine and wrap end around the back.

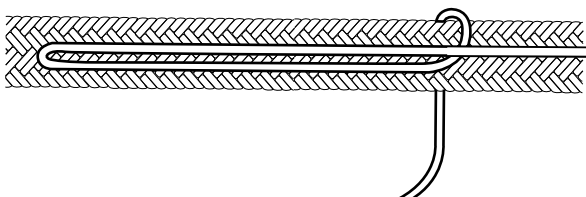

STEP 2 Continue wrapping at least 1 rope diameter in length.

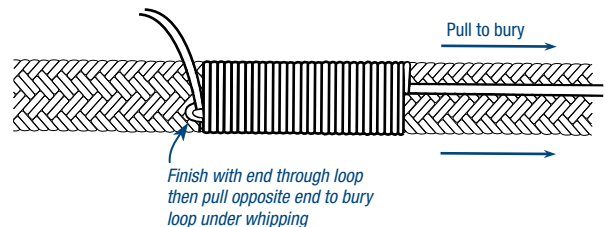

STEP 3 Cut both ends close to whipping.



Seizing Method II

STEP 1

Attach twine to netting needle.

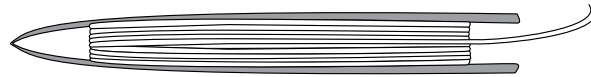

STEP 2

Pass the free end of the twine under a couple of strands in the cover and pull enough twine through to extend beyond the area to be seized.

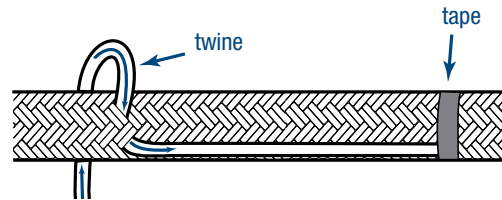

2A Tape the free end of the twine to the opposite side of the area to be seized.

STEP 3

Start seizing. Wrap the needle around the circumference of the rope 1 complete turn. Pass the netting needle under the complete wrap left to right. Pull the loop tight. Pull the needle up maintaining tension on the completed half hitch and then quickly pull back down to lock the half hitch in place.

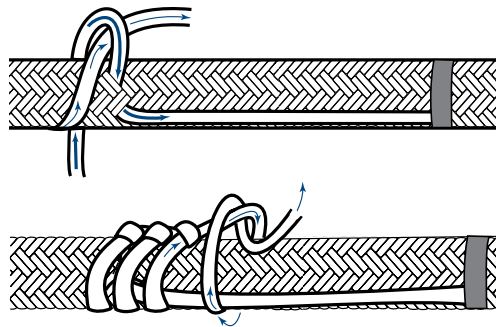

STEP 4

Continue with this procedure until the seized area is approximately 1/2 of the desired length, then cut off the taped end near the last wrap.

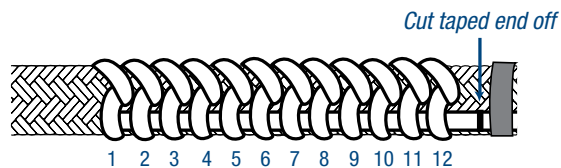

STEP 5

Using some spare twine, tape a loop that covers the length of the intended seizing distance, letting the 2 free ends of the looped twine lay over the completed seizing. Tape the free ends of the loop past the already seized area.

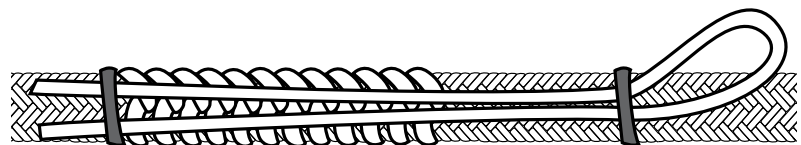

STEP 6

Continue seizing for the desired total length over the top of the looped twine. After seizing is complete, pass the exposed seizing twine through the loop. Remove the tape on the looped twine and pull the ends to draw the loop under the seizing.

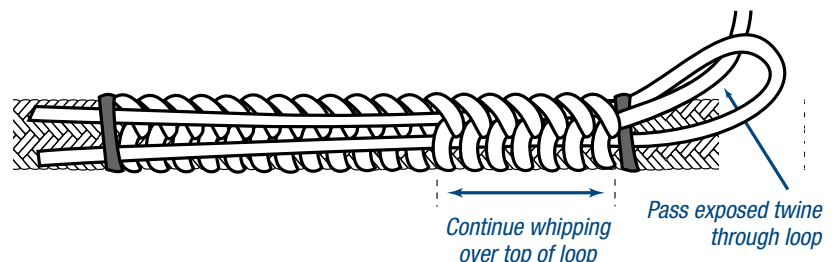

STEP 7

Pull the loop through the seized area. This should place the remaining seizing twine under the seized area. Cut off any excess twine.





Round Plait Class I End-For-End Splice

Class I round plait ropes are made from any or all of the following fibers: olefin, polyester, or nylon. These instructions illustrate a tuck splice that can be performed in the field on new or used rope.

STEP 1 MEASUREMENT

Lay out and measure from the end of each rope a length that is equal to 1 fid length. Wrap tape around the rope (Point A). Tape each of the 12 strands at the end of the rope. After the ends are taped unbraid each rope back to Point A.

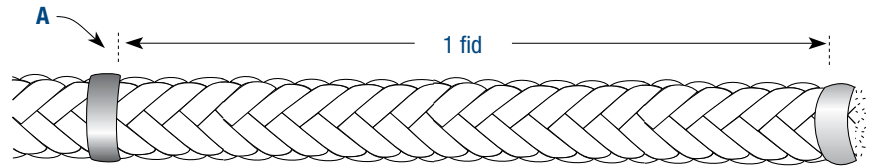

STEP 2 TAPING STRAND PAIRS

Combine the 12 individual strands into 6 pairs of 2 strands each. The strands that are paired up should be adjacent to each other at Point A. If done correctly, there should be 1 "S" strand (clockwise twist), and 1 "Z" strand (counter-clockwise twist) in each pair.

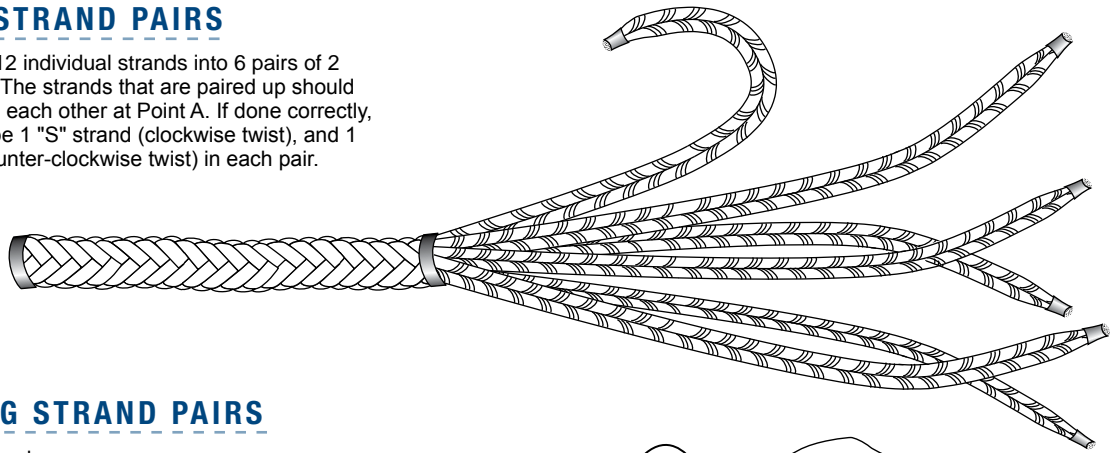

STEP 3 TWISTING STRAND PAIRS

Tape the 2 strands together. It is desirable that these strands retain some twist. To twist the strands, hold the 2 strands as shown and rotate the taped end between the strands to retain the original twist.

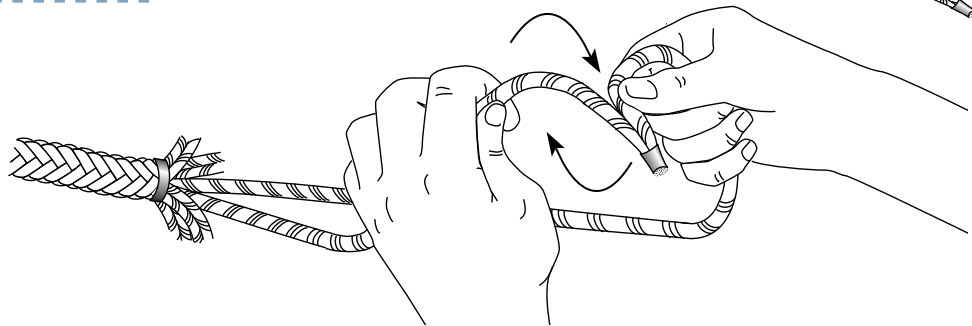

STEP 4 JOINING THE ROPES

Join the 2 ropes together at Point A and combine the pairs by starting at any 1 set of opposing set of strands and inserting 1 pair of strands between the strands of its opposite pair. This step is alternated, right, left, etc., around the rope until all pairs have been joined. Draw strand pairs tight to bring both ropes' Point As together.

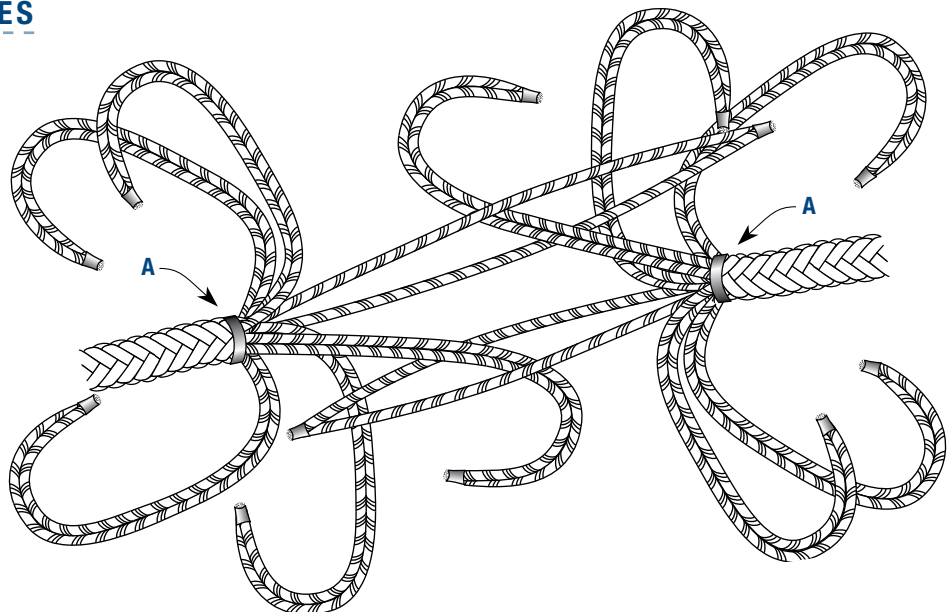



Round Plait Class I End-For-End Splice

STEP 5 TUCKING

Now you can begin to tuck the pairs. 1 complete tuck consists of passing a strand pair over 1 strand and under 2 strands of the body of the rope. Pull the strands through and repeat on opposite pair, tucking straight down the body of the rope.

TIP: When making the tucks, don't pull the strands excessively tight but keep them twisted. This allows the tucked strands to elongate in alignment with the body of the rope, thereby preventing the tucked strands from being prematurely overloaded.

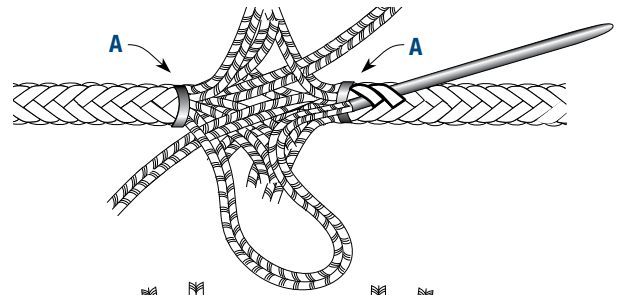

5A Do 1 complete set of tucks on all 12 strand pairs.

Note: When pulling on the strand pairs, do not attempt to pull them so tight that they become straight. It is desirable to leave the tucked strands with some twist in them so that they have the necessary elongation when the rope is placed under a load

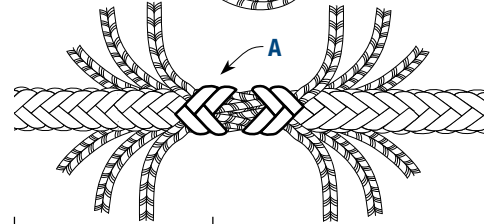

5B Do 3 more complete tucks on each side of the splice with all 6 strand pairs, resulting in 4 total tucks. Each strand pair is always tucked under the same line of braid so that the tuck progresses straight down the body of the rope.

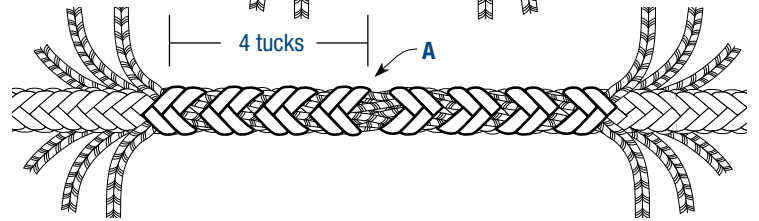

STEP 6 TAPERING THE SPLICE

After completing the first 4 tucks drop every other strand pair and continue to do 3 more tucks with the remaining 3 pairs. This is done on each side of the splice.

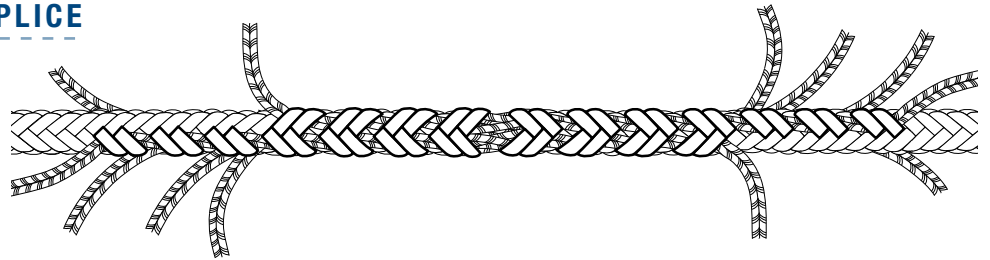

6A Once 3 of the strand pairs have 6 full tucks on each side, separate the strand pairs into individual strands and drop 1 strand in each pair, continuing down 2 more tucks.

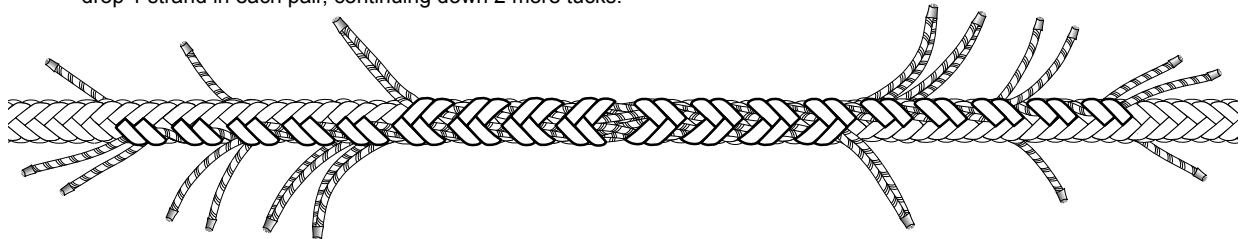

STEP 7 FINISHING THE SPLICE

Once you have completed the last tucks, cut off the excess material and tape or whip the ends. Leave enough of an end protruding so that it does not slip back into the rope when it is loaded.

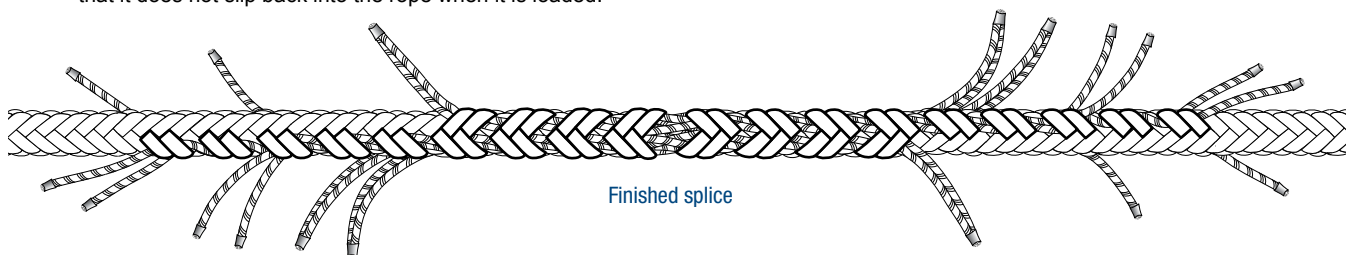



Round Plait Class I Eye Splice

Class I round plait ropes are made from any or all of the following fibers: olefin, polyester, or nylon.

The round plait construction requires a splicing technique different from other 12-strand braided ropes.

The "tuck" procedure may be performed in the field on both new and used rope with a minimum of tools.

The eye splice is used to place a permanent loop in the end of a rope, generally for attachment purposes to a fixed point. An eye is also used to form the rope around a thimble, which is used to protect the rope, especially when it is to be attached to a shackle, chain, or wire rope.

STEP 1 MEASURING AND MARKING

From the end of the rope, measure 1 fid length. At this point put 1 loose wrap of tape around the rope. This is Mark 1.

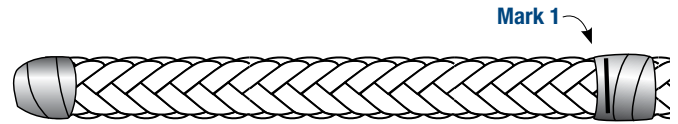

1A Form the desired eye size using the tape wrapped around the rope as a reference mark. Mark the body of the rope at the point where it matches up with Mark 1. This is Mark 2.

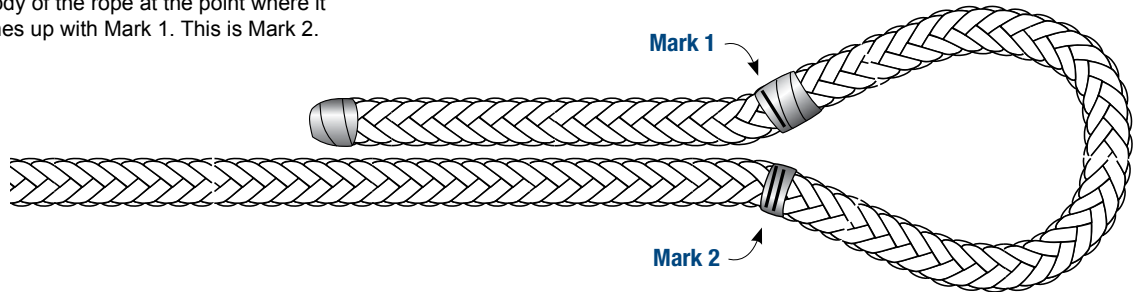

STEP 2 PAIRING THE STRANDS

Divide the 12 individual strands into 6 pairs of 2 strands each. The strands that are paired together should be adjacent to each other at the point where the unbraided rope meets the tape wrapped around the rope. There should be 1 "S" strand (strand with clockwise twist) and 1 "Z" strand (strand with counter-clockwise twist) in each pair. Before taping each set of strands together, twist each strand separately to maintain the twist of the fiber.

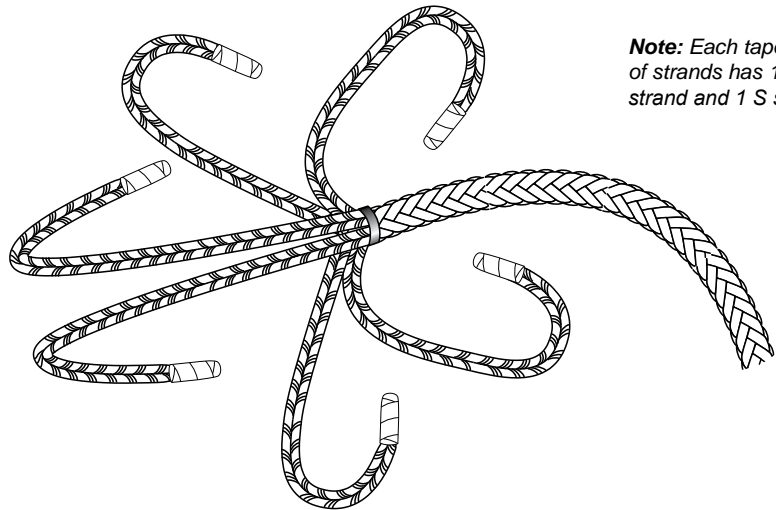

Note: Each taped pair of strands has 1 Z strand and 1 S strand.

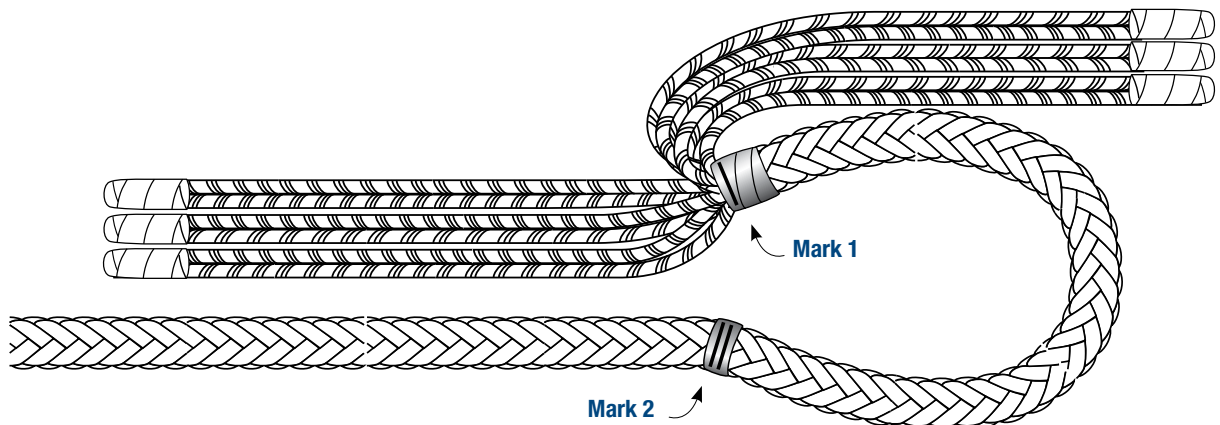



Round Plait Class I Eye Splice

STEP 3 MARKING ENTRY AND EXIT POINTS

At Mark 2, make a mark at the intersection of an S and a Z strand. This will be the entry point for all 6 strands and the tail when it is buried. The entry point should be on the side of the rope facing the opposite leg of the eye.

From the entry point, count 2 picks down the rope and mark 6 strands around the circumference of the rope. There will be 3 S strands and 3 Z strands marked. At each intersection of an S and a Z strand, mark an exit point. There will be 6 exit points marked.

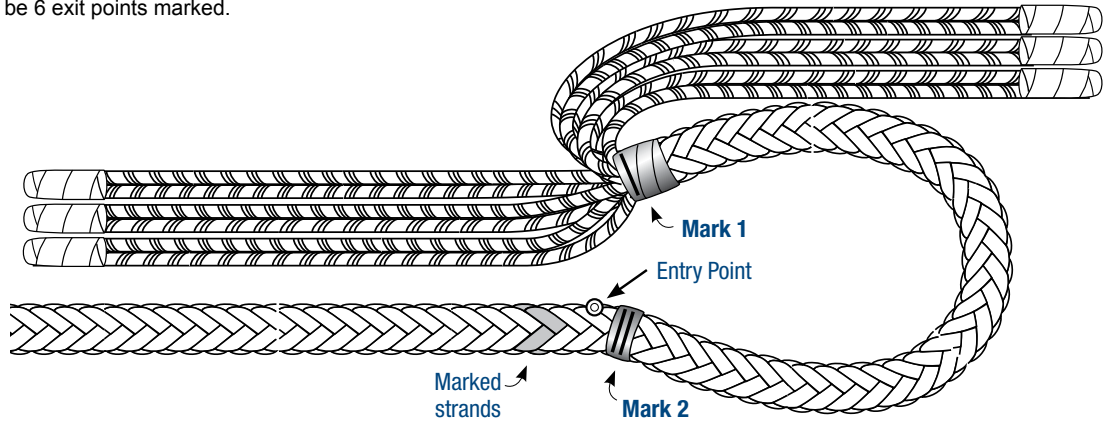
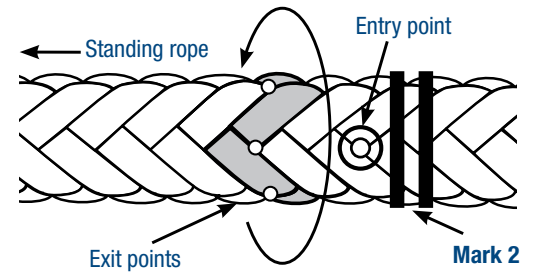

STEP 4 ROUTING THE STRANDS

The first 3 strands closest to the inside of the eye are now routed from the entry point at Mark 2 to the exit points on the opposite side of the rope. Each strand is routed separately, entering at the entry point and exiting at its own exit point. Do not pull the strands up tight yet. Leave slack at the entry point.

4A The 3 remaining strands are now routed from the entry point at Mark 2 to the exit point. Each strand is routed separately, entering at the entry point and exiting at its own exit point. Do not pull the strands up tight yet. Leave slack at the entry point.

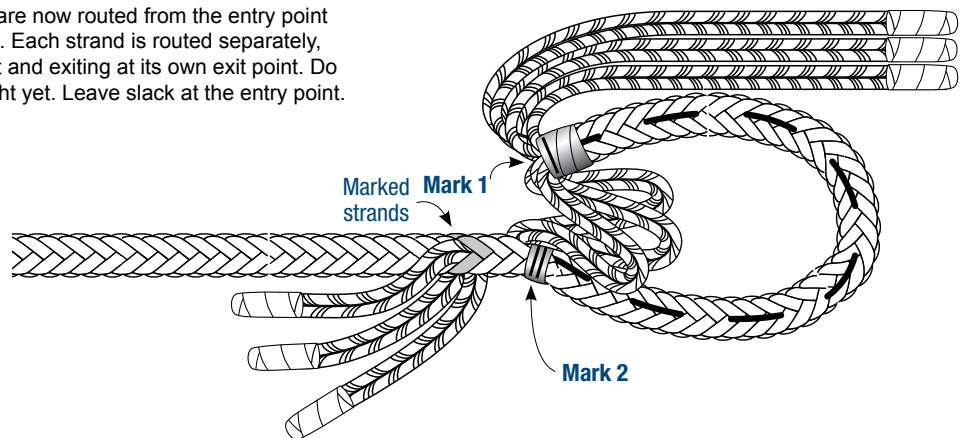

4B With all 6 strands routed, pull each of the 6 routed strands to remove any slack, and make sure the rope is smooth and tight at the entry point.

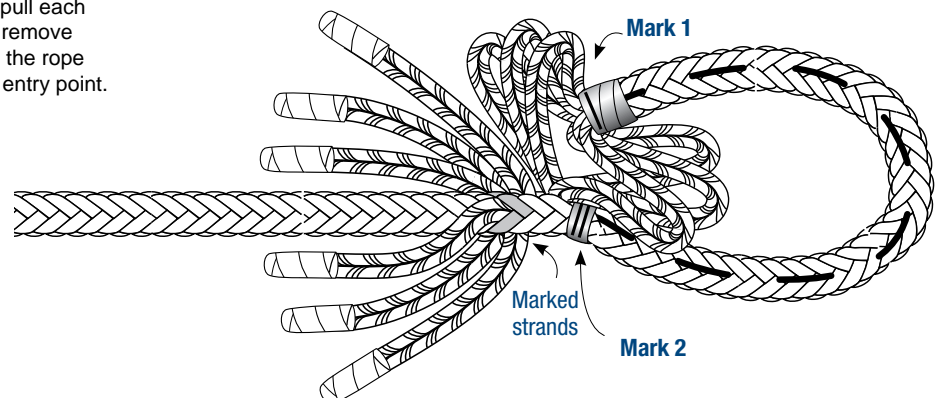



Round Plait Class I Eye Splice

4C When all strand pairs are routed, snug the strands and remove the tape at the base of the tail. Once routed, the strand pairs should have an "X" (overlapping right and left strands) between them or they will touch.

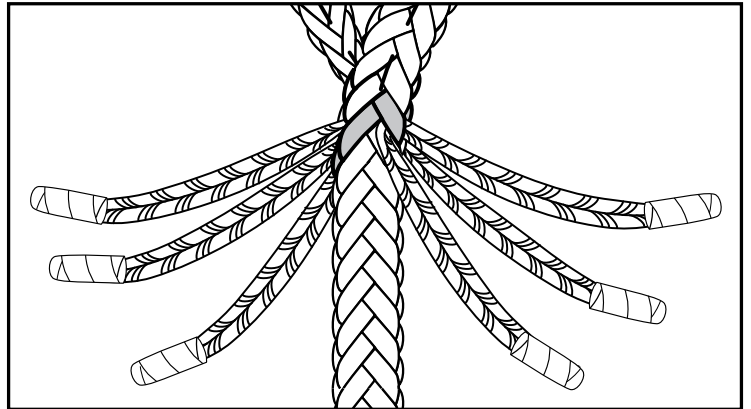

STEP 5 BEGIN TUCKING THE STRAND PAIRS

Begin tucking the strand pairs over 1 and under 2 for 3 tucks. Each strand is tucked down the same row of picks in the braid, over 1 strand and under 2 strands.

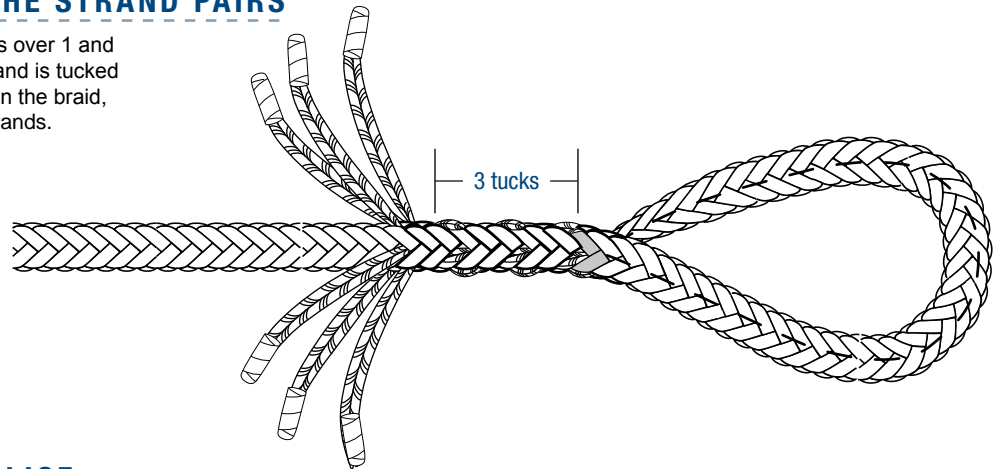

STEP 6 TAPERING THE SPLICE

When all 6 strand pairs have been tucked for 3 tucks, drop every other strand pair. Use the remaining 3 strands to continue down the rope for 3 more tucks.

6A Finally, once 3 of the strand pairs have 6 full tucks, separate the strand pairs into individual strands and drop 1 strand in each pair, continuing down 2 more tucks.

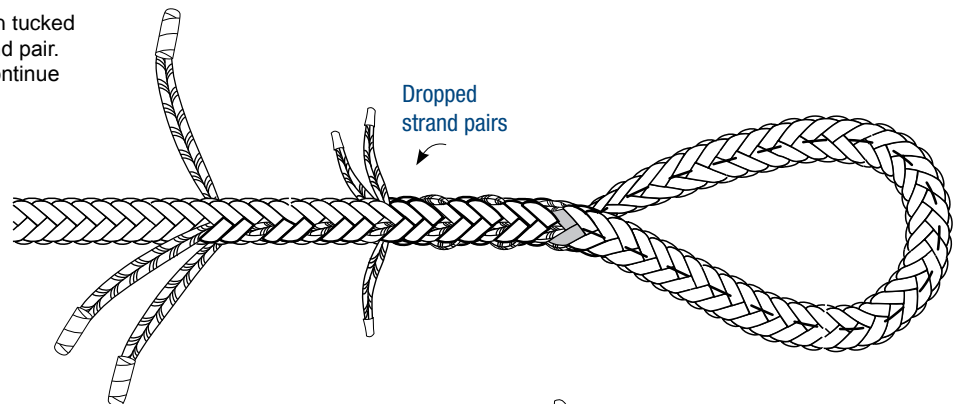

6B Cut the excess tails to complete the splice. Leave enough of an end protruding so that the end does not slip back into the rope when over-loaded.

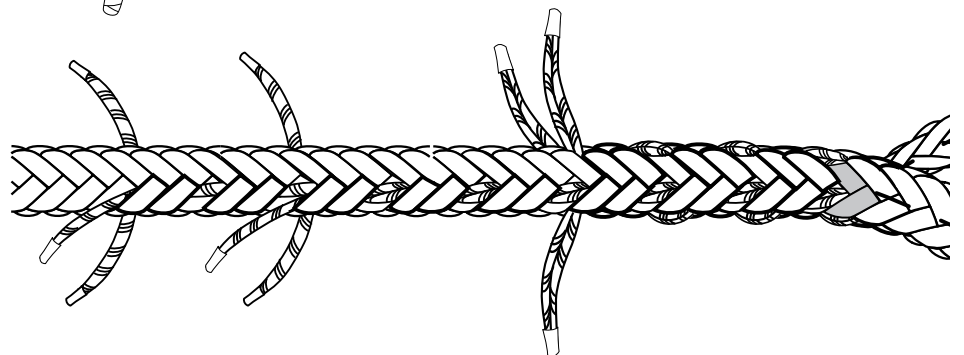

SAMSON SPLICING INSTRUCTIONS



samson
THE STRONGEST NAME IN ROPE

Tools and Materials Required for Splicing

FID

Samson Tubular, Wire or Selma fids are available in a variety of sizes depending on the rope type and diameter you're splicing.

PUSHER

Helpful for extracting cores or pushing a fid through the rope.

TAPE

Masking tape, electrical tape or a similar plastic tape can be used during splicing.

SCISSORS OR KNIFE

For cutting away strands — must be sharp.

TWINE

Good quality nylon braided or twisted twine in a size adequate for the rope diameter being spliced.*

RULER OR TAPE MEASURE

MARKING PEN



**In general, braided nylon twine is preferred for lock stitching. Polyester twines, or twisted twines in either polyester or nylon, can also be used.*

The twine should be approximately the same diameter as 1 strand in the rope. If the rope or the cover of the rope is made up of pairs of strands rather than a single strand, the twine should be about the same diameter as these 2 strands together.

To check for correct twine size, lay the twine over the strands in the rope — if it covers the width of the strand(s), it is the right size.

Splicing Tools

SPLICING KIT

The Samson Splicing Kit comes with 5 aluminum tubular fids (size range 1/4" through 1/2" diameter).



SPLICING TRAINING KIT

The Samson Splice Training Kit comes complete with a fid, pusher, instructions and 2 lengths of double braided ropes.



WIRE AND ALUMINUM TUBULAR FIDS

Our wire fids are 1/2 scale, meaning that the length of the tool is 1/2 the actual fid length for the corresponding rope diameter. Tubular fids are 100% scale, meaning that the overall length of the tool is equal to the actual fid length for the corresponding rope diameter.

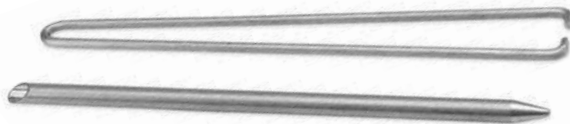

SELMA FIDS

Made from highly polished stainless steel, Selma Fids are patented worldwide. Available in sets of four only, the Selma Fid may be used to splice hollow braided lines from 1/8" to 9/16" or double braid and 3-strand rope up to 1-1/8".



LARGE ALUMINUM FID KIT

Six aluminum tubular fids (size range 1/2" through 1" diameter).





Fid Information

FID LENGTH DEFINITION

The length of the splicing tool, called a "fid," may or may not have a 1:1 correlation with the fid length for a given rope diameter. The "fid length" for a rope is calculated as 21 times the rope diameter. As the rope diameter increases, so does the fid length. For example the fid length for a 4" diameter rope is 84".

To keep fids to a manageable length, they may be scaled to the actual fid length of a given rope diameter. Our tubular fids are 100% scale, meaning that the overall length of the tool is equal to the actual fid length for the corresponding rope diameter. Our wire fids are 1/2 scale, meaning that the length of the tool is 1/2 the actual fid length for the corresponding rope diameter.

TUBULAR FIDS

A different sized splicing fid is required for each size of rope.

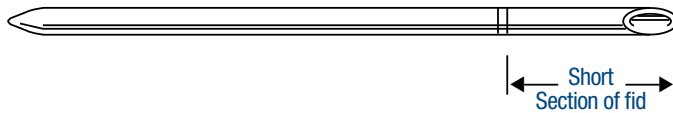

Fid Size = Rope Dia. (Inches)	Total Fid Length (Inches)	Short Fid Section (Inches)
1/4"	5-1/2"	2-1/16"
5/16"	6-3/4"	2-1/2"
3/8"	7-3/4"	2-7/8"
7/16"	9-1/2"	3-9/16"
1/2"	11"	4-1/8"
9/16"	12-1/4"	3-5/8"
5/8"	14"	4-1/8"
3/4"	16"	4-3/4"
7/8"	19"	4-3/4"
1"	21"	5-1/4"

CALCULATING FID SHORT SECTION

1/4" – 1/2" short section is 37.5% of fid length

9/16" – 3/4" short section is 30% of fid length

7/8" and up short section is 25% of fid length

WIRE FIDS

For rope sizes above 3" circumference (1" diameter), use a wire fid. fid scale: 1/2 (for rope diameters between 1" and 2").

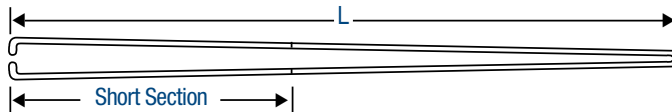

Fid Size = Rope Dia. (Inches)	Total Fid Length "L" (Inches)	Short Section "C" (Inches)
1"	10-1/2"	2-5/8"
1-1/8"	12-1/4"	3"
1-1/4"	13-1/4"	3-1/4"
1-5/16"	14"	3-1/2"
1-1/2"	16"	4"
1-5/8"	17-1/2"	4-1/2"
1-3/4"	19"	4-3/4"
2"	21"	5-1/4"