



2017 ORDER GUIDE

DUTY GEAR | TACTICAL | CONCEALMENT | ACCESSORIES | COMPETITION



Important Consumer Information

SAFETY WARNINGS: READ BEFORE USING SAFARILAND PRODUCTS

Safariland® Holsters and Duty Gear products are designed to meet the demand for high performance products for law enforcement and civilians. Fit and used properly, a holster is a valuable aid in carrying a firearm. Because holsters are used to carry firearms, however, any person purchasing or using a Safariland holster should read and understand the following warning and all instructions included with the holster, as well as be thoroughly familiar with the proper and safe use of his or her firearm in the circumstances in which he or she is using it.

Close tolerances for holster/handgun fit require consistent handgun specifications and characteristics, as well as extremely precise holster design. Safariland produces its products in this manner of quality materials with efficiency and safety in mind. Although these warnings may not pertain to all Safariland products, or all circumstances, they should be read prior to the purchase, sale or use of any product. Some products have special and/or supplemental instructions and/or safety information that must be read prior to their use.

Training and Practice

Use of a handgun under any circumstance may be dangerous. SERIOUS INJURY OR EVEN DEATH may result without proper training in the safe handling of firearms. Proper training should be obtained from an accredited firearms safety program conducted by competent, qualified instructors in the military, police academies or National Rifle Association affiliated instruction programs. A firearm should not be carried or used without a thorough knowledge of its characteristics and safe use in the circumstances in which it intended to be used. It is also the user's responsibility to be certain that his or her firearm is in proper, safe operating condition.

We strongly recommend a regular holster practice regime be utilized to assure the continued capabilities of both the Safariland product and its user.

Proper Holster Fit

NEVER PLACE A LOADED HANDGUN IN A HOLSTER WITHOUT FIRST TESTING FOR PROPER FIT WITH THE HANDGUN UNLOADED. Although Safariland attempts to provide accurate information regarding which specific holster models were designed to accommodate a specifically identified handgun, or handguns, Safariland does not warrant the accuracy of such information and specifically disclaims any responsibility or liability for, or consequences resulting from, errors or inaccuracies in such information. Users are advised not to rely on such compatibility information but are advised to personally verify holster/handgun compatibility in each and every case using actual products.

Handgun manufacturers continually update manufacturing specifications in their quest for better products. These changes may occur one or more times within a particular handgun model year, and make it difficult for proper handgun identification and holster fit.

The slightest change in handgun design can have a major safety effect on the close tolerance of Safariland Duty Gear products. These changes may not affect other holster brands that do not maintain the Safariland duty gear high standards.

If the user has any questions or doubt concerning holster fit, contact Safariland immediately as to which version of a particular handgun you and/or your customer may possess, and its compatibility with Safariland holsters.

Be advised that it is the user's responsibility to periodically check his or her holster and related hardware for proper fit and function. Should any product, including a Safariland duty gear product, become worn, loose, broken, defective or ill fitting, CEASE USE IMMEDIATELY.

Other Very Important Warnings

Cocked Hammers

Do not attempt to cock a handgun while holstered as such cocking can cause severe damage to either the handgun or holster, or both, and may cause an ACCIDENTAL DISCHARGE.

Some users of certain handgun models insist on carrying the weapon in what is referred to as a cocked and locked condition (i.e., the gun is cocked with the safety engaged). Safariland does not recommend or approve of any such practice, and advises against it. This condition for such handguns should be reserved only for the most advanced, experience and skilled professional shooters under conditions that require the handgun to be drawn and fired under extremely short time constraints. Carrying a handgun in this condition INCREASES THE RISK OF ACCIDENTAL DISCHARGE. It should only be used by those who have the training and experience to recognize the inherent risks associated with it.

Take-Away

It should be noted that NO HOLSTER IS COMPLETELY SNATCH-PROOF OR TAKEAWAY-PROOF. Therefore, the user must exercise extreme diligence at all times in any situation where another person may attempt to take the user's handgun. The handgun should be held in place by the user whenever vigorous activity such as running, jumping, falling or tumbling is encountered or attempted. ALWAYS keep safety straps snapped if the holster is so equipped.

Retention

Always point your handgun in a safe direction and use extreme caution when holstering or unholstering your handgun to avoid an accidental discharge. Keep thumb on back of hammer or slide when inserting handgun in holster to help assure no movement occurs during insertion. Always keep fingers clear of trigger when drawing or replacing handgun in holster. Place index finger on outside of trigger guard to resist inadvertent strap or foreign object interference when re-holstering. Be certain the firearm is firmly seated in the holster and that any integral strap is properly engaged.

Loaded Firearms

Carrying a firearm with a live cartridge in the chamber could result in an accidental discharge. Certain single-action revolvers and semiautomatic pistols should only be carried with the hammer or firing pin resting on an empty chamber. It is the user's responsibility to exercise extreme caution when handling or carrying any handgun, and to assume at all times that the gun is loaded.

Alteration

DO NOT use Safariland holsters with custom or modified guns, broken, worn or inferior manufactured guns, including guns that are not of original factory specifications. DO NOT use after-market grips not manufactured by Safariland, grip adapters, target hammers, target triggers, or trigger shoes. After-market handgun modifications may cause improper holster fit and ACCIDENTAL HANDGUN DISCHARGE. Never attempt to modify Safariland Duty Gear products in any way.



Safariland® holsters and duty gear systems are designed to meet the demand for high performance police products. Close tolerances for holster / handgun fit require consistent handgun specifications and characteristics as well as extremely precise holster research and design.

For over 50 years, Safariland has produced products of quality materials with efficiency and safety in mind. For the protection and safety of you and/or your valued customers, it is strongly suggested that these warnings be read, understood, and adhered to prior to the purchase, sale or use of any Safariland product.

Although these warnings may not pertain to all Safariland products, or all circumstances, they should be read prior to the purchase, sale or use of any Safariland product.

Table of Contents

Introduction

About This Order Guide	5
Express Limited Warranty for Holster Products	5
The Ordering Process	6
Shipping and Delivery Information	6
Returns	6
Shipping and Handling Charges	7
Patent, Trademark and Copyright Notice	7

How To Order

Using This Guide	8
To Request Product Images	8
Holster Retention Levels	9
Holster Retention Level Test/Chart	9
Finishes	10
Ordering a Holster	11
Ordering a Competition Holster	11
Ordering a Belt	11
Uncoding Part Numbers	12

Duty Holsters

2 Hi-Ride, Level I Retention™ Holster, for Pistols	13
070 SSIII™ Mid-Ride, Level III Retention™ Holster, for Pistols	15
0705 Low-Ride, Level III Retention™ Holster, for Pistols	15
070 SSIII™ Mid-Ride, Level III Retention™ Holster, for Revolvers	19
0705 Low-Ride, Level III Retention™ Holster, for Revolvers	19
200 Top Gun™ Mid-Ride, Level I Retention™ Holster, for Pistols	20
2005 Top Gun™ Low-Ride, Level I Retention™ Holster, for Pistols	20
200 Top Gun™ Mid-Ride, Level I Retention™ Holster, for Revolvers	24
2005 Top Gun™ Low-Ride, Level I Retention™ Holster, for Revolvers	24
295 Mid-Ride, Level II Retention™ Holster, Pistols Only	25
2955 Low-Ride, Level II Retention™ Holster, Pistols Only	25
6280 SLS Mid-Ride, Level II Retention™ Holster, for Pistols	26
6282 SLS Hi-Ride, Level II Retention™ Holster, for Pistols	26
6285 SLS Low-Ride, Level II Retention™ Holster, for Pistols	26
6280 SLS Mid-Ride, Level II Retention™ Holster, for Revolvers	38
6282 SLS Hi-Ride, Level II Retention™ Holster, for Revolvers	38
6285 SLS Low-Ride, Level II Retention™ Holster, for Revolvers	38
6280RDS SLS Mid-Ride, Level II Retention™ Holster, for Pistols	40
6282RDS SLS Hi-Ride, Level II Retention™ Holster, for Pistols	40
6285RDS SLS Low-Ride, Level II Retention™ Holster, for Pistols	40
6390 ALS® Mid-Ride, Level I Retention™ Holster, for Pistols	41
6392 ALS® Hi-Ride, Level I Retention™ Holster, for Pistols	41
6395 ALS® Low-Ride, Level I Retention™ Holster, for Pistols	41
6390RDS ALS® Mid-Ride, Level I Retention™ Holster, for Pistols	46
6392RDS ALS® Hi-Ride, Level I Retention™ Holster, for Pistols	46
6395RDS ALS® Low-Ride, Level I Retention™ Holster, for Pistols	46
6360 ALS®/SLS, Mid-Ride, Level III Retention™ Holster, for Pistols	47
6362 ALS®/SLS, Hi-Ride, Level III Retention™ Holster, for Pistols	47
6365 ALS®/SLS, Low-Ride, Level III Retention™ Holster, for Pistols	47
6360RDS ALS®/SLS, Mid-Ride, Level III Retention™ Holster, for Pistols	53
6362RDS ALS®/SLS, Hi-Ride, Level III Retention™ Holster, for Pistols	53
6365RDS ALS®/SLS, Low-Ride, Level III Retention™ Holster, for Pistols	53
6520 SLS Clip-On Style, Level II Retention™	55
7280 7TS™ SLS Mid-Ride Level II Retention™ Holster, for Pistols	56
7282 7TS™ SLS Hi-Ride Level II Retention™ Holster, for Pistols	56
7285 7TS™ SLS Low-Ride Level II Retention™ Holster, for Pistols	56
7360 7TS™ ALS®/SLS Mid-Ride Level III Retention™ Holster, for Pistols	60
7362 7TS™ ALS®/SLS Hi-Ride Level III Retention™ Holster, for Pistols	60
7365 7TS™ ALS®/SLS Low-Ride Level III Retention™ Holster, for Pistols	60
7390 7TS™ ALS® Level I Retention™ Mid-Ride Duty Holster, for Pistols	64
7392 7TS™ ALS® Level I Retention™ Hi-Ride Duty Holster, for Pistols	64
7395 7TS™ ALS® Level I Retention™ Low-Ride Duty Holster, for Pistols	64
7520 EDW/7TS™ SLS Clip-On Style, Level II Retention™	68

Duty Holsters (continued)

7280/7360/7390 CAS™-Camera Activation System	69
SLS/ALS® Accessories	70

Duty Accessories

Belt Loop Accessories for 3-Hole Pattern Holsters	71
HRA High Ride Adaptor	71
35 Baton Holder	71
67 Baton Ring, w/o Snap	72
135 Baton Holder	72
692S Baton Ring, w/ Snap	72
62 Belt Keeper, Hidden Snap	73
63 Belt Keeper, Slotted, 2-Snap	73
65 Belt Keeper, 2-Snap	73
654 Belt Keeper, Slotted, 4-Snap	74
655 Belt Keeper, Heavy Duty, 2-Snap	74
HK-11 Hide A Keyper Belt Keeper	75
730 Key Ring, 2-Snap	75
168 Key Ring, 2-Snap	75
169S Key Ring, 1-Snap	76
170 Silent Key Holder	76
690 Handcuff Strap, 1-Snap	76
HK-10 Handcuff Key	76
306 Open Top Mini Flashlight Holder	77
307 Light/EDW Cartridge Holder	77
308 Hand-Held Flashlight Holder	78
090/090H Handcuff Case, Open Top	78
090-1 Handcuff Case, Open Top	78
90/90H Handcuff Case	79
190/190H Handcuff Case, Top Flap, 1-Snap	79
290 Double Handcuff Case, Top Flap, 1-Snap	80
290H Double Handcuff Case, Top Flap, 1-Snap	80
33 Surgical Glove Holder	80
761 Radio Holder, Adjustable	81
762 Radio Holder, Swivel	81
763 Radio Holder, Universal Fit	81
764 Tape Recorder Holder, Adjustable	82
766 Radio Holder	82
34 Open Top OC Holder	82
36 Open Top OC Holder	83
37 Open Top Mace®/OC Spray Holder	83
38, 38HS Mace®/OC Spray Holder, Top Flap	84
72 Double Magazine and Cuff Pouch	86
73 Double Duty Open Top Magazine Pouch	87
74 Magazine and Rifle Pouch	89
75 Open Top Double Magazine Pouch	90
76 Single Magazine Pouch	92
77 Double Magazine Pouch	95
78 Slimline Double Magazine Pouch	97
79 Slimline Open Top Double Magazine Pouch	98
277 Quad Magazine Pouch	99
775 Slimline Open Top Triple Magazine Pouch	100
777 Slimline Triple Magazine Pouch	101
7350-01 Badge Holder, Clip-On	102
7350-03 Badge Holder, Clip-On	102
7350-04 Badge Holder, Clip-On	103
7352 Badge Holder w/ Neck Chain	103

Tactical Holsters

6004 SLS Tactical Holster, for Pistols	105
6005 SLS Tactical Holster w/ Quick-Release, for Pistols	105
6004RDS SLS Tactical Holster, for Pistols	118
6005RDS SLS Tactical Holster w/Quick-Release, for Pistols	118
6004 SLS Tactical Holster, for Revolvers	119

Table of Contents

Tactical Holsters (continued)

6005 SLS Tactical Holster w/ Quick-Release, for Revolvers	119
6034 SLS Military Tactical Holster, for Pistols	121
6035 SLS Military Tactical Holster w/ Quick-Release, for Pistols	121
6230 SLS Military Mid-Ride Holster, for Pistols	122
6235 SLS Military Low-Ride Holster, for Pistols	122
6304 ALS®/SLS Tactical Holster, for Pistols	123
6305 ALS®/SLS Tactical Holster w/ Quick-Release, for Pistols	123
6304RDS ALS®/SLS Tactical Holster, for Pistols	129
6305RDS ALS®/SLS Tactical Holster w/Quick-Release, for Pistols	129
6354 ALS® Tactical Holster, for Pistols	130
6355 ALS® Tactical Holster w/ Quick-Release, for Pistols	130
6354RDS ALS® Tactical Holster, for Pistols	135
6355RDS ALS® Tactical Holster w/Quick-Release, for Pistols	135
6354DO ALS® Optic Tactical Holster, for Pistols	136
6378USN ALS® Low Signature Holster, for Pistols	137
6384 ALS® OMV Tactical Holster, for Pistols	138
6385 ALS® OMV Tactical Holster w/ Quick-Release, for Pistols	138
6384RDS ALS® OMV Tactical Holster, for Pistols	143
6385RDS ALS® OMV Tactical Holster w/Quick-Release, for Pistols	143
7004 7TS™ SLS Tactical Holster, for Pistols	145
7005 7TS™ SLS Tactical Holster w/ Quick-Release, for Pistols	145
7304 7TS™ ALS® Tactical Holster, for Pistols	149
7305 7TS™ ALS® Tactical Holster w/ Quick-Release, for Pistols	149
7354 7TS™ ALS® Tactical Holster	153
7355 7TS™ ALS® Tactical Holster w/ Quick-Release	153
7384 7TS™ ALS® OMV Tactical Holster, for Pistols	157
7385 7TS™ ALS® OMV Tactical Holster w/ Quick-Release, for Pistols	157

Tactical Accessories

35 Baton Holder	161
37 Open Top Mace®/OC Spray Holder	161
38 OC Spray Holder	161
40 Distraction Device® Holder	162
76 Single Magazine Pouch	162
77 Double Magazine Pouch	163
78 Slimline Double Magazine Pouch	163
79 Slimline Open Top Double Magazine Pouch	164
775 Slimline Open Top Triple Magazine Pouch	164
777 Slimline Triple Magazine Pouch	164
190 Single Handcuff Case	164
307 Light/EDW Cartridge Holder	165
308 Hand-Held Flashlight Holder	165
774 Rifle Magazine Pouch	165
MPA Mounting Pattern Adaptor	165
TMA Tactical MOLLE Adapter....	165
4332 Tactical ELS Belt, 2" (50mm)	166
4552 Dual Rifle Case	167
6004-6 Double Strap Leg Shroud	168
6004-10 Single Strap Leg Shroud	168
6004-110 Lightweight Leg Shroud	169
6004DFA Drop Flex Adapter	169
6004UFA Universal Flex Adapter	170
6004-4 Leg Shroud Only	171
6004-14 Single Strap Leg Shroud Only	171
6004-114 Lightweight Leg Shroud Only	171
6004-11 Vertical Leg Strap Only	171
6004-8 Small MOLLE Adapter Plate	171
6005-6 Double Strap Leg Shroud w/ Quick-Release	172
6005-10 Single Strap Leg Shroud w/ Quick-Release	172
6005-110 Lightweight Leg Shroud w/ Quick-Release	172
6005-7 Buckle Portion of Quick-Release Leg Strap	173
6005-11 Quick-Release Leg Strap Only	173
6005-23 MLS Accessory Fork on Quick-Release Strap	173
6005VE Quick-Release Buckle with Enhanced Hook & Loop Belt Attachment	173

Tactical Accessories (continued)

6009-6 Double Strap Leg Shroud w/ D-Ring	173
6009VE D-Ring Strap with Enhanced Hook & Loop Belt Attachment	174
6009-10 Single Strap Leg Shroud w/ D-Ring	174
6009-110 Lightweight Leg Shroud w/ D-Ring	174
6009-11 D-Ring Leg Strap Only	174

Duty and Garrison Belts

031 D-Ring Belt w/ Loop Lining, 1.5" (38mm)	175
51 Garrison w/ Square Buckle 1.75" (45mm)	175
87 Suede Lined Belt w/ Buckle, 2.25" (58mm)	175
87V Suede Lined Hook and Loop System, 2.25" (58mm)	176
94 Buckleless™ w/ Hook and Loop System, 2.25" (58mm)	176
94P Buckleless™ w/o Hook and Loop, 2.25" (58mm)	176
99 Buckleless™ Reversible, 1.5" (38mm)	177
146 Border Patrol, 2.25" (58mm)	177
146V Border Patrol Belt w/ Hook and Loop System, 2.25" (58mm)	178
872 Suede Lined Contour Duty Belt , 2.25" (58mm)	178
875 Sam Browne Duty, 2.25" (58mm)	179
942 Contour Style Duty Belt, w/ Hook and Loop System, 2" (50mm) or 2.25" (58mm)	179
942P Contour Duty Belt w/o Hook and Loop, 2.25" (58mm)	179
992 Buckleless™ Reversible, Contour, 1.5" (38mm)	180
999 Garrison Hook and Loop Closure, 1.5" (38mm)	180
4320 Padded Belt Liner	181
4325 Nylok® Pro Buckleless™ Reversible Belt, Loop Lined	181
4330 Padded Belt Liner	181
4832 Light Weight Duty Belt	182
Replacement Belt Buckles	182
P-2200 Duty Holster Belt Loop Insert Adapter	182
P-2201 Duty Holster UBL Insert Adapter	182

Quick Attachment Systems

ELS 34 Equipment Locking Fork	183
ELS 35 Equipment Receiver Plate	183
MLS 16 MOLLE Accessory Locking Fork	184
QLS 19 Quick Locking Fork	184
QLS 22 Quick Receiver Plate	185
QLS 22L Quick Receiver Plate	185
ELS-KIT Equipment Locking Kit	185
QUICK-KIT1 Quick Locking System Kit	186
QUICK-KIT2 Quick Locking System Kit	186
QUICK-KIT3 Quick Locking System Kit	186
QUICK-KIT4 Quick Locking System Kit	186
6004-24 MLS 16 on MOLLE Plate	186

Speedloaders & Accessories

COMP I Speedloader	187
COMP II Speedloader	187
COMP III Speedloader	187
CD-2 CD-2 Speedloader Holder, up to 2" (50mm) Belt Clip	188
333 Triple Speedloader Holder	188
340 Dual Speedloader Pouch, 2-Snap	189
371 Split-Six Speedloader Pouch, Leather, 1.5" (38mm) – 1.75" (45mm)	189

Light Systems

RLS-3 RLS™ Rapid Light System	190
RLS-0 RLS™ Mount Only	190
LGT-3 RLS™ Light Only	190
RLSM Mount for Duty Belt	190
RLSR Reduction Sleeve	191
RLSP RLS™ w/ Pressure Switch	191
RRL Rogers® Rail Lite	191

Table of Contents

HOLSTER FOR: SINGLE ACTION REVOLVERS

Concealment Holsters

18 Inside-The-Waistband Holster, for Pistols	192
18 Inside-The-Waistband Holster, for Revolvers	193
22 Wallet Profile Holster, for Pistols	193
25 Inside-The-Pocket Holster, for Pistols	194
25 Inside-The-Pocket Holster, for Revolvers	194
27 Inside-The-Pants Holster, for Pistols	195
27 Inside-The-Pants Holster, for Revolvers	196
537 GLS™ Open Top Concealment Belt Slide Holster	197
547 PRD™ Open Top Concealment Belt Slide Holster	198
566 Custom Fit Hi-Ride Belt Slide, for Pistols	199
567 Custom Fit Belt Loop Holster, for Pistols	199
568 Custom Fit Paddle & Belt Loop Holster, for Pistols	199
569 Custom Fit Belt Clip Holster, for Pistols	199
566 Custom Fit Hi-Ride Belt Slide Holster, for Revolvers	204
567 Custom Fit Loop Holster, for Revolvers	204
568 Custom Fit Paddle & Belt Loop Holster, for Revolvers	204
569 Custom Fit Belt Clip Holster, for Revolvers	204
575 GLS™ Pro-Fit™ Inside-Waistband-Holster, for Pistols	206
576 GLS™ Pro-Fit™ Hi-Ride Belt Slide Holster, for Pistols	207
577 GLS™ Pro-Fit™ Belt Slide Holster, for Pistols	207
578 GLS™ Pro-Fit™ Paddle & Belt Slide Combo, for Pistols	207
579 GLS™ Pro-Fit™ Belt Clip Holster, for Pistols	207
1051 ALS® Shoulder Holster, for Pistols	211
1053 ALS® Universal Shoulder Holster, for Pistols	212
5186 Open Top Hi Ride Concealment Belt Slide Holster, for Pistols	216
5188 Open Top Concealment Paddle and Belt Slide Holster, for Pistols	216
5186 Open Top Hi Ride Concealment Belt Slide Holster, for Revolvers	218
5188 Open Top Concealment Paddle and Belt Slide Holster, for Revolvers	218
5195 Range Series Open Top Low-Ride Holster, for Pistols	219
5196 Open Top Concealment Hi Ride Belt Slide Holster, for Pistols	221
5198 Open Top Concealment Paddle and Belt Loop Holster, for Pistols	221
5199 Open Top Concealment Belt Clip Holster, for Pistols	221
5196 Open Top Concealment Hi Ride Belt Slide Holster, for Revolvers	224
5198 Open Top Concealment Paddle and Belt Loop Holster, for Revolvers	224
5199 Open Top Concealment Belt Clip Holster, for Revolvers	224
5197 Range Series Open Top Mid Ride Holster, for Pistols	225
6287 SLS Belt Loop Holster, for Pistols	227
6367 ALS®/SLS Belt Loop Holster, for Pistols	236
6376 ALS® Hi Ride Belt Slide Holster, for Pistols	242
6377 ALS® Belt Loop Holster, for Pistols	242
6378 ALS® Paddle and Belt Loop Holster, for Pistols	242
6379 ALS® Belt Clip Holster, for Pistols	242
6376 ALS® Hi Ride Belt Slide Holster, for Revolvers	247
6377 ALS® Belt Loop Holster, for Revolvers	247
6378 ALS® Paddle and Belt Loop Holster, for Revolvers	247
6379 ALS® Belt Clip Holster, for Revolvers	247
7287 7TS™ SLS Belt Slide Holster, for Pistols	248
7367 7TS™ ALS®/SLS Concealment Belt Slide Holster, for Pistols	251
7376 7TS™ ALS® Hi Ride Belt Slide Holster, for Pistols	254
7377 7TS™ ALS® Belt Loop Holster, for Pistols	254
7378 7TS™ ALSv Paddle and Belt Loop Holster, for Pistols	254
7379 7TS™ ALS® Belt Clip Holster, for Pistols	254

Concealment Accessories

CD-AUTO Clip-On Magazine Holder	257
71 Injection-Molded Single Magazine Pouch	259
71MSA MOLLE Sliding Adapter	259
81 Open Top Lightweight Magazine Pouch	260
123 Horizontal Magazine Pouch	262
074 Open Top Single Magazine Pouch, Paddle	262
079 Open Top Double Magazine Pouch, Snap-On	266
572 Open Top Concealment Double Magazine Pouch, Paddle	268
573 Open Top Magazine & Handcuff Pouch	270

Concealment Accessories (continued)

574 Magazine Holder and Light Pouch, Paddle	272
590 Open Top Handcuff Case, Paddle	274
L820 Leather Plainclothes Belt, 1.25" (32mm)	274
L830 Leather Plainclothes Belt, 1.5" (38mm)	274

Competition Holsters

TEAM SAFARILAND	275
002 Cup Challenge, for Revolvers	276
014 Open Class Competition Holster, for Pistols	278

Competition Accessories

030 Competition Underbelt, Loop Liner	279
USPSA Kit	279
014 Adpator Kit	279
032 ELS Competition Belt	280
332 Ranger Series Belt, 1.5" (38mm)	280
334 Rigid Competition Belt, 1.5" (38mm)	280
075-2 Hearing Protector Holder	281
077BL Belt Loop Accessory	281
J-KTR Loading Block	281
J-LP Loading Block	281
771 Competition Open Front Magazine Pouch	282
744BL Accessory Belt Clip	284
773 Competition Open Top Magazine Pouch	284
774 Rifle Magazine Pouch	286
776 Competition Magnetic Magazine Pouch	286
6005-12 Shotgun Speedloader Holder	287
080-12 Shotgun Shell Holder, 12-Gauge	287
081-12 Rivet Mount Shot Shell Holder	287
085 4-Round Shell Holder	288
086 Shotshell Holder	288
333 Triple Speedloader Holder	289
4553 Dual Handgun Case	290
4555 Shooters' Range Bag	291
4556 3-Gun Competition Case	291

Apparel

TS-2900 Safariland Long-Sleeve Polo	292
TS-3200 Safariland Performance T-Shirt	292
TS-6600 Safariland Men's Performance Polo Shirt	293
TS-6610 Safariland Women's Performance Polo Shirt	293
TS-9250 Safariland Hat	293
TS-9255 Safariland Hat	293

Sales Support

BAN-200-3 Safariland Banner 3'x3'	294
BAN-200-9 Safariland Banner 9'x3'	294
SAF-CUP-2 Safariland Tumbler	294
SAF-MUG-2 Safariland Mug	294
TV-DVD Training DVDs	294
In-Store Support Items	294

Index

Listed by Model Number	295
------------------------	-----

About This Order Guide

The **Safariland Duty Gear Order Guide** helps facilitate the ordering of our line of holsters, duty gear and accessories. It's a comprehensive reference published periodically.

The **Safariland Duty Gear Ordering Guide** is primarily designed for use by the nationwide network of Authorized Safariland Dealers. Any law enforcement personnel involved in the purchasing or specifying of law enforcement equipment will find it helpful and very informative.

ONE IMPORTANT WORD OF CAUTION. A perfect ordering guide for holsters and accessories is nonexistent. Nor is an ordering guide of this size and complexity ever completed. With more than 17,000 part numbers—and 15 major gun manufacturers introducing new models regularly—it's a demanding and tedious process that never ends.

This edition represents our best effort to provide accurate information needed to select and order any Safariland product. However, human error may occur and we would appreciate hearing of any mistakes the reader may discover. Also, everyone's unique situation cannot be anticipated; therefore, toll-free technical support is offered. The Safariland Group welcomes any suggestions that may improve this Order Guide.

Express Limited Warranty for Holster Products

Safariland, LLC (the "Company") warrants its holster products to be free from defects in materials and workmanship for a period of two (2) years from date of purchase. This warranty is subject to the proper care and maintenance of the product and proper use of the product as detailed in the Consumer and Safety Information.

If you believe this product has any defects in materials or workmanship, cease use immediately and contact customer care for a remedy. If a product proves to be defective in material or workmanship, we will repair or replace the product and send it to you at the Company's expense. All returns must include the proof of purchase and documentation specifying the claimed defect.

This is a LIMITED WARRANTY, and is the sole and exclusive warranty of this product by the Company. It shall not be enlarged by any representations, descriptions, course of dealing, trade usage, rendering of technical advice, service or otherwise. Furthermore, it shall not be altered or expanded by any acts, statements, or agreements of any dealer, employee or agent of the Company (other than by a duly authorized officer of the Company).

THE COMPANY MAKES NO OTHER WARRANTIES EXPRESS, IMPLIED, OR STATUTORY, INCLUDING WITHOUT LIMITATION ANY IMPLIED WARRANTY OF FITNESS FOR A PARTICULAR PURPOSE OR MERCHANTABILITY.

IN NO EVENT SHALL THE COMPANY BE LIABLE FOR ANY PUNITIVE, EXEMPLARY, OR CONSEQUENTIAL DAMAGES, ANTICIPATED OR LOST PROFITS, INCIDENTAL DAMAGES, LOSS OF TIME, OR OTHER INDIRECT LOSSES OR EXPENSES THAT ARISE FROM ANY CAUSE RELATING TO THE PRODUCT, REGARDLESS OF THE FORM OF THE ACTION, WHETHER IN TORT (INCLUDING NEGLIGENCE), CONTRACT, STRICT LIABILITY OR OTHERWISE, AND REGARDLESS OF WHETHER THE COMPANY HAS BEEN ADVISED OF THE POSSIBILITY OF SUCH CONSEQUENTIAL DAMAGES. SOME STATES DO NOT ALLOW THE EXCLUSION OR LIMITATION OF INCIDENTAL OR CONSEQUENTIAL DAMAGES, SO THE ABOVE LIMITATION OR EXCLUSION MAY NOT APPLY TO YOU. THIS WARRANTY GIVES YOU SPECIFIC LEGAL RIGHTS, AND YOU MAY ALSO HAVE OTHER RIGHTS WHICH VARY FROM STATE TO STATE.

Some distributed items not manufactured by Safariland contain their own manufacturer's warranty statement of terms of sale. PRICES, PRODUCTS DESIGN, AND AVAILABILITY ARE SUBJECT TO CHANGE WITHOUT NOTICE.

Patent, Trademark and Copyright Notices

Many of the products offered in this publication are protected by one or more of the following United States patents: D458,828 – D453,068 – 7,694,860 – 7,441,364 – 6,588,640 – 5,944,239 – 5,931,358 – 9,109,857

Canadian patents: 2,171,381. Australian letters 676,978. Italian patents: 1,323,161 – 1,323,145 – 82,628. Other U.S. and international patents pending.

Level I Retention™, Level II Retention™, Level III Retention™, Level IV Retention™ and Level V Retention™ and their corresponding definitions are trademarks of Safariland.

Many product names, model numbers and product features referred to in this publication are registered trademarks of Safariland. All rights reserved. Taser® is a registered trademark of TASER International. Streamlight® and Stinger® are registered trademarks of Streamlight, Inc.

WARNING:

This guide may not be duplicated in any way without the expressed written consent of The Safariland Group. The information and images contained herein may not be duplicated in other books, catalogs, advertisements, price sheets, databases or any other medium without the written consent of Safariland, LLC. Making copies of this guide, or any portion thereof for any purpose other than your own use, is a violation of United States copyright laws.

Safariland, LLC and/or its agents have used their best efforts to assure accuracy in the preparation of this publication. No warranty of any kind is made, expressed or implied, with regard to the information, prices, images and/or products contained in this order guide.



The Safariland Group has a long standing reputation for developing innovative products for the world's law enforcement community. Accordingly, many of the products offered in this publication are currently protected by one or more patents and/or trademarks.

How to Order
Duty Holsters
Duty Accessories
Tactical Holsters
Tactical Accessories
Duty Belts
OAS
Speed Loaders
Light Systems
Concealment Holsters
Concealment Accessories
Competition
Apparel
Sales Support
Index/Price List

How to Order

Using This Guide

Safariland's **Duty Gear Order Guide** is set up so almost anyone can order holsters duty gear and accessories with ease. It's intended to minimize the need for prior Safariland product knowledge. That is, it can be used as a stand-alone reference.

How It's Organized:

This guide is divided into 13 product categories, i.e., Duty Holsters, Duty Belts, etc. Each section is then organized numerically by product type.

For holsters models are listed in numerical order by model. Duty holsters are listed with hi-ride, mid-ride, and low-ride versions in one section. Concealment holsters are listed with belt slide, paddle, and belt clip versions in one section. All holster models list pistols and revolvers separately.

For accessories—the products are listed numerically in ascending order by type. All belt keepers will be listed, starting with the lowest model number to the highest, then all handcuff cases, etc.

To Quickly Find an Item:

Turn to the Table of Contents on Page 2. Scan the major section headings for the product group. Then, look down the numerical listing for the correct or similar product type. Once you've located similar product descriptions, you can also refer to the model numbers in the first column.

Then, turn to the appropriate page to scan the illustrations and product header bars. Under many of the images, there's a brief description of the product next to a list of part numbers.

If you know the Safariland model number you are looking for, you may also refer to the index beginning on page 277.

- Duty Holsters are listed numerically; look for icon identifying retention level.
- Duty Accessories are listed numerically in ascending order by product type (i.e. handcuff pouches, mag pouches, etc.)
- Tactical, Concealment and Competition are listed numerically in ascending order.

How to Order

Finishes

Safariland offers the widest variety of finishes for its products of any holster manufacturer. Each finish had a numerical code that is part of the product part number. The chart below lists all **standard finish offerings** and their corresponding number codes.

Following are Safariland standard finish offerings, along with their specific finish code. These finishes require no minimums, and lead time to receive items ordered in these finishes is less than 30 days. Safariland custom finishes do require a minimum order. Contact our Customer Service department for more information.

Standard Finishes	Finish Codes
BLACK, PLAIN	-2, -6 or -16
BLACK, BASKET	-4, -8 or -18
BLACK, HI GLOSS	-9
BLACK, STX PLAIN	-41
BLACK, STX BASKET	-48
BLACK, STX HI GLOSS	-49
BLACK, STX TACTICAL®	-12, -13 or -23
FOLIAGE GREEN FOR TACTICAL HOLSTERS & ACCESSORIES	-54
COYOTE BROWN FOR TACTICAL HOLSTERS & ACCESSORIES	-76
FDE BROWN FOR TACTICAL HOLSTERS & ACCESSORIES	-55
OD GREEN FOR TACTICAL HOLSTERS & ACCESSORIES	-56
BLACK, NYLON LOOK	-26 or -22

Condura Finishes	Finish Codes
MULTICAM®	-701
RANGER GREEN	-731
COYOTE	-741
KHAKI	-751
BLACK	-781

Ordering a Holster

The holster part number contains all of the information you'll need to place an order. The following is a sample of a duty holster listing:

GUN DESCRIPTION	FINISH	COLOR	RIGHT HAND	LEFT HAND
Colt	Plain	Black	070-51-161	070-51-162
Commander	Basket	Black	070-51-181	070-51-182
4.25" BBL	Hi Gloss	Black	070-51-91	070-51-92

All gun barrel length measurements are shown to help ensure that the proper holster is ordered. To accurately measure a gun's barrel length, please refer to the illustrations showing the correct reference points for measuring a pistol, revolver or competition handgun.

Holsters are available in both right and left hand versions and some are ambidextrous. Safariland's part number system for these three variations is noted as the last digit of the part number.

1=Right 2=Left 3=Ambidextrous

NOTE: Gun barrel lengths are measured in Imperial standard. Where applicable, all other measurements are indicated in both Imperial & Metric standards.

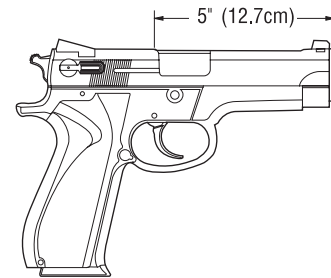

Pistols are measured from the back portion of the ejection port to the end of the barrel.

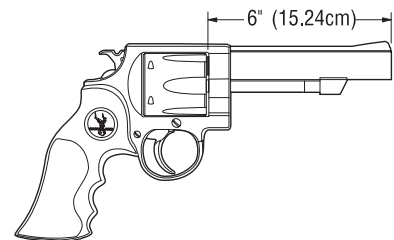

Revolver barrel lengths are measured from the face of the cylinder to the end of the barrel.

Ordering a Competition Holster

The holster part number contains all of the information you'll need to place an order. Here's a sample of a competition holster listing:

GUN DESCRIPTION	FINISH	COLOR	RIGHT HAND	LEFT HAND
Springfield Armory	Plain	Black	014-853-121	014-853-122
1911 Compensator	Plain	Red	014-853-351	014-853-352
6.5" BBL				

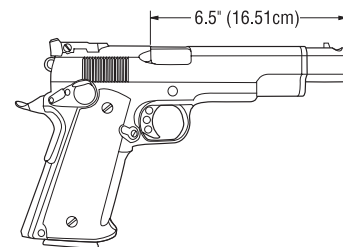

Competition pistol barrel lengths are measured from the back portion of the ejection port to the end of the compensator.

Ordering a Belt

All Safariland Duty and Garrison Belts are available in **even belt sizes** from 24" to 44" (61cm to 112cm). Oversized belts are also available at additional cost. To order any belt, simply replace the **XX** size code in the Safariland part number with **an even belt size**, such as **34**.

PART NO. SHOWN	ACTUAL PART NO.
51-XX-2	51-34-2

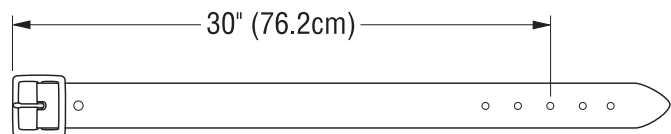

All Safariland 2.25" (58mm) Duty Belts are designed to be worn over a Garrison type pants belt. When ordering a Duty Belt, give your **actual waist size** – do not add inches – Safariland automatically compensates for the extra length. Belts that are not 2.25" (58mm) wide, such as Garrison, Competition, and Sportsman Belts should always be measured as shown in the above illustration.

Uncoding Part Numbers

Accessories

76 - 83 - 2

MODEL#	CENTER CODE	FINISH CODE
76 (Single Magazine) Pouch	83 Glock 17, 22	2 = Plain Black 4 = Basket Black 9 = Hi Gloss Black 13 = STX Tactical® Black
77 (Double Magazine) Pouch	76 S&W 59, BER 92	26 = Nylon Look 41 = STX Plain Black 48 = STX Basket Black 49 = STX Hi Gloss Black
777 (Triple Magazine) Pouch	53 Colt Govt 1911	54 = STX Foliage Green 55 = STX FDE Brown 56 = STX OD Green

Belts

146 - 36 - 2

MODEL#	CENTER CODE	FINISH CODE
146 (Border Patrol) w/ Buckle	32	2 = Plain Black Chrome Buckle 2B = Plain Black Brass Buckle 4 = Basket Black Chrome Buckle 4B = Basket Black Brass Buckle
875 (Stitched Edge) w/ Buckle	36	9 = Hi Gloss Black Chrome Buckle 9B = Hi Gloss Black Chrome Buckle
99 (Buckleless™ Reversible)		

Holsters

2005 - 83 - 181 - 2

MODEL#	1.5" DROP	CENTER CODE	FINISH CODE	L/H OR R/H	BELT SIZE
200 Top Gun	2005	83 Glock 17, 22	6 = Plain Black	1 RH	175
070 Holster SSIII	0705	383 Glock 20, 21	8 = Basket Black 9 = Hi Gloss Black 12 = STX Tactical® Black	2 LH	150 125
6280 SLS Duty Holster	6285	74 SIG P229	13 = STX Tactical® Black		225
014 Competition Holster	N/A	853 STI/SVI	16 = Plain Black 18 = Basket Black 26 = Nylon Look		2
6390 ALS Duty Holster	6395	149 Springfield Armory XD	41 = STX Plain		



2 HI-RIDE LEVEL I RETENTION™ HOLSTER FOR: PISTOLS

FEATURES

- ▶ Level I Retention™ holster
- ▶ Molded, slotted belt loop design
- ▶ Hi-ride position, slightly forward grip cant permits fast, easy draws
- ▶ Excellent weapon retention; thumb break with one-way directional snap
- ▶ For pistols only
- ▶ Offered in 2.25" (58mm) belt slots

- ▶ Available in Plain Black, Basketweave, Nylon Look and Hi Gloss finishes
- ▶ Safariland offers training DVDs for various products. For more information on retention levels please review TV-1007D

*Order Code for Nylon Look finish:
Replace X with center code and 1 (RH) or 2 (LH)
Nylon Look 2-XX-26X



GUN DESCRIPTION	FINISH*	COLOR	RIGHT	LEFT
AMT Hardballer, 5" BBL	Plain	Black	2-53-61-2R	2-53-62-2R
	Basket	Black	2-53-81-2R	2-53-82-2R
	Hi Gloss	Black	2-53-91-2R	2-53-92-2R
Beretta 92FC Compact, 92FCM Compact, 92FCDA, 92FS Centurion, 96DC, 96 Centurion 4.3" BBL	Plain	Black	2-73-61-2R	2-73-62-2R
	Basket	Black	2-73-81-2R	2-73-82-2R
	Hi Gloss	Black	2-73-91-2R	2-73-92-2R
Colt Combat Elite, Delta Elite, Delta Gold Cup, Gold Cup Nat'l Match, Government 1911 5" BBL	Plain	Black	2-53-61-2R	2-53-62-2R
	Basket	Black	2-53-81-2R	2-53-82-2R
	Hi Gloss	Black	2-53-91-2R	2-53-92-2R
Glock 17, 22 4.5" BBL 19, 23 4" BBL	Plain	Black	2-83-61-2R	2-83-62-2R
	Basket	Black	2-83-81-2R	2-83-82-2R
	Hi Gloss	Black	2-83-91-2R	2-83-92-2R
Glock 20, 21, 4.6" BBL, 29, 30 3.78" BBL	Plain	Black	2-383-61-2R	2-383-62-2R
	Basket	Black	2-383-81-2R	2-383-82-2R
	Hi Gloss	Black	2-383-91-2R	2-383-92-2R
Heckler & Koch USP 9mm, .40 4.13" BBL	Plain	Black	2-91-61-2R	2-91-62-2R
	Basket	Black	2-91-81-2R	2-91-82-2R
	Hi Gloss	Black	2-91-91-2R	2-91-92-2R
Heckler & Koch HK .45 4.53" BBL	Plain	Black	2-91-61-2R	2-91-62-2R
	Basket	Black	2-91-81-2R	2-91-82-2R
	Hi Gloss	Black	2-91-91-2R	2-91-92-2R
Kimber KIP45CUS 5" BBL	Plain	Black	2-53-61-2R	2-53-62-2R
	Basket	Black	2-53-81-2R	2-53-82-2R
	Hi Gloss	Black	2-53-91-2R	2-53-92-2R
Para-Ordnance P14 5" BBL	Plain	Black	2-53-61-2R	2-53-62-2R
	Basket	Black	2-53-81-2R	2-53-82-2R
	Hi Gloss	Black	2-53-91-2R	2-53-92-2R
Ruger P-85, KP-89, KP-89 DAO, KP-89 DAOW, KP-89 DC, KP-89 DW, KP-89 W, P-89, P-89 DC, P-89 DW, P-89 W, 9mm 4.5" BBL	Plain	Black	2-67-61-2R	2-67-62-2R
	Basket	Black	2-67-81-2R	2-67-82-2R
	Hi Gloss	Black	2-67-91-2R	2-67-92-2R
Ruger P-90, P-90 DC, KP-90, KP-90 DC, KP-90 W, KP-90 DW, 45 ACP 4.5" BBL	Plain	Black	2-67-61-2R	2-67-62-2R
	Basket	Black	2-67-81-2R	2-67-82-2R
	Hi Gloss	Black	2-67-91-2R	2-67-92-2R
Ruger KP-91 DC, KP-91 DAO, P-91 DC, P-91 DAO, 40 S&W 4.5" BBL	Plain	Black	2-67-61-2R	2-67-62-2R
	Basket	Black	2-67-81-2R	2-67-82-2R
	Hi Gloss	Black	2-67-91-2R	2-67-92-2R
Sig Sauer P220, P226 4.41" BBL	Plain	Black	2-77-61-2R	2-77-62-2R
	Basket	Black	2-77-81-2R	2-77-82-2R
	Hi Gloss	Black	2-77-91-2R	2-77-92-2R

How to Order
Duty Holsters
Duty Accessories
Tactical Holsters
Tactical Accessories
Duty Belts
QAS
Speed Loaders
Light Systems
Concealment Holsters
Concealment Accessories
Competition
Apparel
Sales Support
Index/Price List

Duty Holsters



2 HI-RIDE LEVEL I RETENTION™ HOLSTER FOR: PISTOLS

GUN DESCRIPTION	FINISH*	COLOR	RIGHT	LEFT
Sig Sauer P225, P228, P229 3.86" BBL	Plain	Black	2-74-61-2R	2-74-62-2R
	Basket	Black	2-74-81-2R	2-74-82-2R
	Hi Gloss	Black	2-74-91-2R	2-74-92-2R
Smith & Wesson 39, 59, 411, 439, 459, 639, 659, 915, 3904, 3906, 4006, 4026, 5903, 5904, 5906, 5923, 5924, 5926 4" BBL	Plain	Black	2-140-61-2R	2-140-62-2R
	Basket	Black	2-140-81-2R	2-140-82-2R
	Hi Gloss	Black	2-140-91-2R	2-140-92-2R
Smith & Wesson 469, 669, 3913, 3913LS, 3913NL, 3913TSW, 3914, 3914LS, 6904, 6906, 6924, 6926 3.5" BBL	Plain	Black	2-20-61-2R	2-20-62-2R
	Basket	Black	2-20-81-2R	2-20-82-2R
	Hi Gloss	Black	2-20-91-2R	2-20-92-2R
Smith & Wesson 3953, 3954, 3953TSW, 6946 3.5" BBL	Plain	Black	2-240-61-2R	2-240-62-2R
	Basket	Black	2-240-81-2R	2-240-82-2R
	Hi Gloss	Black	2-240-91-2R	2-240-92-2R
Smith & Wesson 4046, 5946 4" BBL	Plain	Black	2-240-61-2R	2-240-62-2R
	Basket	Black	2-240-81-2R	2-240-82-2R
	Hi Gloss	Black	2-240-91-2R	2-240-92-2R
Smith & Wesson 1006, 1026, 4506-1, 4526 5" BBL	Plain	Black	2-210-61-2R	2-210-62-2R
	Basket	Black	2-210-81-2R	2-210-82-2R
	Hi Gloss	Black	2-210-92-2R	2-210-92-2R
Smith & Wesson 645, 4506 5" BBL	Plain	Black	2-23-61-2R	2-23-62-2R
	Basket	Black	2-23-81-2R	2-23-82-2R
	Hi Gloss	Black	2-23-91-2R	2-23-92-2R
Smith & Wesson Sigma 9F, Sigma 40F 4.5" BBL	Plain	Black	2-40-61-2R	2-40-62-2R
	Basket	Black	2-40-81-2R	2-40-82-2R
	Hi Gloss	Black	2-40-91-2R	2-40-92-2R
Springfield Armory 1911-A1 5" BBL	Plain	Black	2-53-61-2R	2-53-62-2R
	Basket	Black	2-53-81-2R	2-53-82-2R
	Hi Gloss	Black	2-53-91-2R	2-53-92-2R
Taurus PT-92C, PT-99C 4" BBL PT-92, PT-99 5" BBL	Plain	Black	2-73-61-2R	2-73-62-2R
	Basket	Black	2-73-81-2R	2-73-82-2R
	Hi Gloss	Black	2-73-91-2R	2-73-92-2R

How to Order
Duty Holsters
Duty Accessories
Tactical Holsters
Tactical Accessories
Duty Belts
OAS
Speed Loaders
Light Systems
Concealment Holsters
Concealment Accessories
Competition
Apparel
Sales Support
Index/Price List



Duty Holsters

070/0705 SSIII™ LEVEL III RETENTION™ HOLSTERS FOR: PISTOLS



070 MID-RIDE



0705 LOW-RIDE

FEATURES

- ▶ Level III Retention™ holster
- ▶ Slight forward grip cant allow for comfortable carry and quick, easy draw
- ▶ Top thumb break and middle finger release tab, internal ejection port lock
- ▶ For pistols only
- ▶ Offered in 2.25" (58mm) belt slots
- ▶ Available in Plain Black, Basketweave, Hi Gloss and Nylon Look finishes

- ▶ Safariland offers training DVDs for various products. For more information on retention levels and this product please review TV-1007D and TV-1023D

*Order Code for Nylon Look finish:
Replace X with center code and 1 (RH) or 2 (LH)
Nylon Look 070-XX-26X

GUN DESCRIPTION	FINISH*	COLOR	070 MID-RIDE		0705 LOW-RIDE	
			RIGHT	LEFT	RIGHT	LEFT
AMT Hardballer 5" BBL	Plain	Black	070-53-161	070-53-162	0705-53-161	0705-53-162
	Basket	Black	070-53-181	070-53-182	0705-553-181	0705-53-182
	Hi Gloss	Black	070-53-91	070-53-92	0705-553-91	0705-53-92
Beretta 8000, 8040 Cougar G, F, D 3.6" BBL	Plain	Black	070-71-161	070-71-162	0705-71-161	0705-71-162
	Basket	Black	070-71-181	070-71-182	0705-71-181	0705-71-182
	Hi Gloss	Black	070-71-91	070-71-92	0705-71-91	0705-71-92
Beretta 8045 Cougar G, F, D 3.6" BBL	Plain	Black	070-70-161	070-70-162	0705-70-161	0705-70-162
	Basket	Black	070-70-181	070-70-182	0705-70-181	0705-70-182
	Hi Gloss	Black	070-70-91	070-70-92	0705-70-91	0705-70-92
Beretta 92D, 92DS, 92F, 92FS, 92G, 96D, 96DS, 96, 96G, 92, 96 Vertec w/ Rails 4.9" BBL	Plain	Black	070-73-161	070-73-162	0705-73-161	0705-73-162
	Basket	Black	070-73-181	070-73-182	0705-73-181	0705-73-182
	Hi Gloss	Black	070-73-91	070-73-92	0705-73-91	0705-73-92
Beretta 92FC, 92FCM Compact, 92FCDA, 92FS Centurion, 92DC, 96 Centurion 4.3" BBL	Plain	Black	070-273-161	070-273-162	0705-273-161	0705-273-162
	Basket	Black	070-273-181	070-273-182	0705-273-181	0705-273-182
	Hi Gloss	Black	070-273-91	070-273-92	0705-273-91	0705-273-92
Beretta 92 Brigadier FS, 92 Brigadier D, 96 Brigadier, 96 Brigadier G, 96 Brigadier G 4.9" BBL	Plain	Black	070-373-161	070-373-162	0705-373-161	0705-373-162
	Basket	Black	070-373-181	070-373-182	0705-373-181	0705-373-182
	Hi Gloss	Black	070-373-91	070-373-92	0705-373-91	0705-373-92
Browning Hi-Power 9mm 4.625" BBL	Plain	Black	070-76-161	070-76-162	0705-76-161	0705-76-162
	Basket	Black	070-76-181	070-76-182	0705-76-181	0705-76-182
	Hi Gloss	Black	070-76-91	070-76-92	0705-76-91	0705-76-92
Colt Combat Elite, Delta Elite, Delta Gold Cup, Gold Cup Nat'l Match, Government 1911 5" BBL	Plain	Black	070-53-161	070-53-162	0705-53-161	0705-53-162
	Basket	Black	070-53-181	070-53-182	0705-53-181	0705-53-182
	Hi Gloss	Black	070-53-91	070-53-92	0705-53-91	0705-53-92
Colt Commander 4.25" BBL	Plain	Black	070-51-161	070-51-162	0705-51-161	0705-51-162
	Basket	Black	070-51-181	070-51-182	0705-51-181	0705-51-182
	Hi Gloss	Black	070-51-91	070-51-92	0705-51-91	0705-51-92



Duty Holsters

070/0705 SSIH™ LEVEL III RETENTION™ HOLSTERS FOR: PISTOLS (continued)

How to Order
Duty Holsters
Duty Accessories
Tactical Holsters
Tactical Accessories
Duty Belts
OAS
Speed Loaders
Light Systems
Concealment Holsters
Concealment Accessories
Competition
Apparel
Sales Support
Index/Price List

GUN DESCRIPTION	FINISH*	COLOR	070 MID-RIDE		0705 LOW-RIDE	
			RIGHT	LEFT	RIGHT	LEFT
Glock 17, 22, 4.5" BBL 19, 23, 4" BBL	Plain	Black	070-83-161	070-83-162	0705-83-161	0705-83-162
	Basket	Black	070-83-181	070-83-182	0705-83-181	0705-83-182
	Hi Gloss	Black	070-83-91	070-83-92	0705-83-91	0705-83-92
Glock 20, 21 4.6" BBL	Plain	Black	070-383-161	070-383-162	0705-383-161	0705-383-162
	Basket	Black	070-383-181	070-383-182	0705-383-181	0705-383-182
	Hi Gloss	Black	070-383-91	070-383-92	0705-383-91	0705-383-92
Glock 34, 35 5.32" BBL	Plain	Black	070-683-161	070-683-162	0705-683-161	0705-683-162
	Basket	Black	070-683-181	070-683-182	0705-683-181	0705-683-182
	Hi Gloss	Black	070-683-91	070-683-92	0705-683-91	0705-683-92
Glock 37 4.5" BBL	Plain	Black	070-783-161	070-783-162	0705-783-161	0705-783-162
	Basket	Black	070-783-181	070-783-182	0705-783-181	0705-783-182
	Hi Gloss	Black	070-783-91	070-783-92	0705-783-91	0705-783-92
Heckler & Koch USP 9C, 40C 3.58" BBL	Plain	Black	070-291-161	070-291-162	0705-291-161	0705-291-162
	Basket	Black	070-291-181	070-291-182	0705-291-181	0705-291-182
	Hi Gloss	Black	070-291-91	070-291-92	0705-291-91	0705-291-92
Heckler & Koch USP 9mm, .40 4.25" BBL	Plain	Black	070-91-161	070-91-162	0705-91-161	0705-91-162
	Basket	Black	070-91-181	070-91-182	0705-91-181	0705-91-182
	Hi Gloss	Black	070-91-91	070-91-92	0705-91-91	0705-91-92
Heckler & Koch USP 45C 3.8" BBL	Plain	Black	070-293-161	070-293-162	0705-293-161	0705-293-162
	Basket	Black	070-293-181	070-293-182	0705-293-181	0705-293-182
	Hi Gloss	Black	070-293-91	070-293-92	0705-293-91	0705-293-92
Heckler & Koch USP .45 4.41" BBL	Plain	Black	070-93-161	070-93-162	0705-93-161	0705-93-162
	Basket	Black	070-93-181	070-93-182	0705-93-181	0705-93-182
	Hi Gloss	Black	070-93-91	070-93-92	0705-93-91	0705-93-92
Heckler & Koch HK .45 4.53" BBL	Plain	Black	070-91-161	070-91-162	0705-91-161	0705-91-162
	Basket	Black	070-91-181	070-91-182	0705-91-181	0705-91-182
	Hi Gloss	Black	070-91-91	070-91-92	0705-91-91	0705-91-92
Kimber KIP45CUS 5" BBL	Plain	Black	070-53-161	070-53-162	0705-53-161	0705-53-162
	Basket	Black	070-53-181	070-53-182	0705-53-181	0705-53-182
	Hi Gloss	Black	070-53-91	070-53-92	0705-53-91	0705-53-92
Para-Ordnance P14 5" BBL	Plain	Black	070-53-161	070-53-162	0705-53-161	0705-53-162
	Basket	Black	070-53-181	070-53-182	0705-53-181	0705-53-182
	Hi Gloss	Black	070-53-91	070-53-92	0705-53-91	0705-53-92
Ruger P-85, KP-89, KP-89 DAO, KP-89 DAOW, KP-89 DC KP-89 DW, KP-89 W, P-89, P-89 DC, P-89 DW, P-89 W, 9mm 4.5" BBL	Plain	Black	070-65-161	070-65-162	0705-65-161	0705-65-162
	Basket	Black	070-65-181	070-65-182	0705-65-181	0705-65-182
	Hi Gloss	Black	070-65-91	070-65-92	0705-65-91	0705-65-92
Ruger P-90, P-90 DC, KP-90, KP-90 DC, KP-90 W KP-90 DW, 45 ACP, 4.5" BBL	Plain	Black	070-67-161	070-67-162	0705-67-161	0705-67-162
	Basket	Black	070-67-181	070-67-182	0705-67-181	0705-67-182
	Hi Gloss	Black	070-67-91	070-67-92	0705-67-91	0705-67-92
Ruger KP-91 DC, KP-91 DAO, P-91 DC, P-91 DAO, 40 S&W 4.5" BBL	Plain	Black	070-67-161	070-67-162	0705-67-161	0705-67-162
	Basket	Black	070-67-181	070-67-182	0705-67-181	0705-67-182
	Hi Gloss	Black	070-67-91	070-67-92	0705-67-91	0705-67-92
Sig Sauer P220, P226 4.41" BBL	Plain	Black	070-77-161	070-77-162	0705-77-161	0705-77-162
	Basket	Black	070-77-181	070-77-182	0705-77-181	0705-77-182
	Hi Gloss	Black	070-77-91	070-77-92	0705-77-91	0705-77-92
Sig Sauer P220R DAK, P226R DAK, w/ Light Rails (Bobbed Hammer) 4.41" BBL	Plain	Black	070-1774-161	070-1774-162	0705-1774-161	0705-1774-162
	Basket	Black	070-1774-181	070-1774-182	0705-1774-181	0705-1774-182
	Hi Gloss	Black	070-1774-91	070-1774-92	0705-1774-91	0705-1774-92
Sig Sauer P220R, P220S, P226R, P226S, P226SO w/ Accessory Rail, P220 after P220 after SN G158180 P226 after SN 365426 4.41" BBL	Plain	Black	070-777-161	070-777-162	0705-777-161	0705-777-162
	Basket	Black	070-777-181	070-777-182	0705-777-181	0705-777-182
	Hi Gloss	Black	070-777-91	070-777-92	0705-777-91	0705-777-92
Sig Sauer P225 3.86" BBL	Plain	Black	070-79-161	070-79-162	0705-79-161	0705-79-162
	Basket	Black	070-79-181	070-79-182	0705-79-181	0705-79-182
	Hi Gloss	Black	070-79-91	070-79-92	0705-79-91	0705-79-92



Duty Holsters

070/0705 SSITM LEVEL III RETENTIONTM HOLSTERS FOR: PISTOLS (continued)

How to Order
Duty Holsters
Duty Accessories
Tactical Holsters
Tactical Accessories
Duty Belts
DAS
Speed Loaders
Light Systems
Concealment Holsters
Concealment Accessories
Competition
Apparel
Sales Support
Index/Price List

GUN DESCRIPTION	FINISH*	COLOR	070 MID-RIDE		0705LOW-RIDE	
			RIGHT	LEFT	RIGHT	LEFT
Sig Sauer P226R Elite 4.41" BBL	Plain	Black	070-777-161	070-777-162	0705-777-161	0705-777-162
	Basket	Black	070-777-181	070-777-182	0705-777-181	0705-777-182
	Hi Gloss	Black	070-777-91	070-777-92	0705-777-91	0705-777-92
Sig Sauer P228, P229, 9mm, .40 S&W .357 3.86" BBL	Plain	Black	070-74-161	070-74-162	0705-74-161	0705-74-162
	Basket	Black	070-74-181	070-74-182	0705-74-181	0705-74-182
	Hi Gloss	Black	070-74-91	070-74-92	0705-74-91	0705-74-92
Sig Sauer P229R 3.86" BBL	Plain	Black	070-744-161	070-744-162	0705-744-161	0705-744-162
	Basket	Black	070-744-181	070-744-182	0705-744-181	0705-744-182
	Hi Gloss	Black	070-744-91	070-744-92	0705-744-91	0705-744-92
Sig Sauer P229R DAK, (Bobbed Hammer) w/ Light Rails 3.9" BBL	Plain	Black	070-1744-161	070-1744-162	0705-1744-161	0705-1744-162
	Basket	Black	070-1744-181	070-1744-182	0705-1744-181	0705-1744-182
	Hi Gloss	Black	070-1744-91	070-1744-92	0705-1744-91	0705-1744-92
Sig Sauer P239, 9mm 3.625" BBL	Plain	Black	070-75-161	070-75-162	0705-75-161	0705-75-162
	Basket	Black	070-75-181	070-75-182	0705-75-181	0705-75-182
	Hi Gloss	Black	070-75-91	070-75-92	0705-75-91	0705-75-92
Sig Sauer P239 357/40 S&W 3.625" BBL	Plain	Black	070-754-161	070-754-162	0705-754-161	0705-754-162
	Basket	Black	070-754-181	070-754-182	0705-754-181	0705-754-182
	Hi Gloss	Black	070-754-91	070-754-92	0705-754-91	0705-754-92
Sig Sauer Sig Pro SP2340 3.875" BBL	Plain	Black	070-78-161	070-78-162	0705-78-161	0705-78-162
	Basket	Black	070-78-181	070-78-182	0705-78-181	0705-78-182
	Hi Gloss	Black	070-78-91	070-78-92	0705-78-91	0705-78-92
Smith & Wesson 39, 59, 439, 459, 639, 659, 915, 3904, 3906, 5903, 5904, 5906, 5923, 5924, 5926 4" BBL	Plain	Black	070-18-161	070-18-162	0705-18-161	0705-18-162
	Basket	Black	070-18-181	070-18-182	0705-18-181	0705-18-182
	Hi Gloss	Black	070-18-91	070-18-92	0705-18-91	0705-18-92
Smith & Wesson 411, 4006, 4026 4" BBL	Plain	Black	070-140-161	070-140-162	0705-140-161	0705-140-162
	Basket	Black	070-140-181	070-140-182	0705-140-181	0705-140-182
	Hi Gloss	Black	070-140-91	070-140-92	0705-140-91	0705-140-92
Smith & Wesson 469, 669, 3913, 3913LS, 3913NL, 3914, 3914LS, 6904, 6906, 6924, 6926 3.5" BBL	Plain	Black	070-20-161	070-20-162	0705-20-161	0705-20-162
	Basket	Black	070-20-181	070-20-182	0705-20-181	0705-20-182
	Hi Gloss	Black	070-20-91	070-20-92	0705-20-91	0705-20-92
Smith & Wesson 4006TSW, w/ Bolt on S&W, Light Rail 4006TSW, w/ Picatinny Light Rail 4" BBL	Plain	Black	070-141-161	070-141-162	0705-141-161	0705-141-162
	Basket	Black	070-141-181	070-141-182	0705-141-181	0705-141-182
	Hi Gloss	Black	070-141-91	070-141-92	0705-141-91	0705-141-92
Smith & Wesson 3953, 3954 3.5" BBL	Plain	Black	070-218-161	070-218-162	0705-218-161	0705-218-162
	Basket	Black	070-218-181	070-218-182	0705-218-181	0705-218-182
	Hi Gloss	Black	070-218-91	070-218-92	0705-218-91	0705-218-92
Smith & Wesson 645, 4506 5" BBL	Plain	Black	070-23-161	070-23-162	0705-23-161	0705-23-162
	Basket	Black	070-23-181	070-23-182	0705-23-181	0705-23-182
	Hi Gloss	Black	070-23-91	070-23-92	0705-23-91	0705-23-92
Smith & Wesson 1006, 1026, 4506-1, 4526 5" BBL	Plain	Black	070-210-161	070-210-162	0705-210-161	0705-210-162
	Basket	Black	070-210-181	070-210-182	0705-210-181	0705-210-182
	Hi Gloss	Black	070-210-91	070-210-92	0705-210-91	0705-210-92
Smith & Wesson 1066, 4566 4.25" BBL	Plain	Black	070-315-161	070-315-162	0705-315-161	0705-315-162
	Basket	Black	070-315-181	070-315-182	0705-315-181	0705-315-182
	Hi Gloss	Black	070-315-91	070-315-92	0705-315-91	0705-315-92
Smith & Wesson 1076, 4576 4.25" BBL	Plain	Black	070-310-161	070-310-162	0705-310-161	0705-310-162
	Basket	Black	070-310-181	070-310-182	0705-310-181	0705-310-182
	Hi Gloss	Black	070-310-91	070-310-92	0705-310-91	0705-310-92
Smith & Wesson 1086, 4586 4.25" BBL, 4556 3.75" BBL	Plain	Black	070-410-161	070-410-162	0705-410-161	0705-410-162
	Basket	Black	070-410-181	070-410-182	0705-410-181	0705-410-182
	Hi Gloss	Black	070-410-91	070-410-92	0705-410-91	0705-410-92
Smith & Wesson M&P 9mm, .40 w/ & w/o Thumb Safety 4.25" BBL	Plain	Black	070-619-161	070-619-162	0705-619-161	0705-619-162
	Basket	Black	070-619-181	070-619-182	0705-619-181	0705-619-182
	Hi Gloss	Black	070-619-91	070-619-92	0705-619-91	0705-619-92



Duty Holsters

070/0705 SSIH™ LEVEL III RETENTION™ HOLSTERS FOR: PISTOLS (continued)

How to Order
Duty Holsters
Duty Accessories
Tactical Holsters
Tactical Accessories
Duty Belts
OAS
Speed Loaders
Light Systems
Concealment Holsters
Concealment Accessories
Competition
Apparel
Sales Support
Index/Price List

GUN DESCRIPTION	FINISH*	COLOR	070 MID-RIDE		0705 LOW-RIDE	
			RIGHT	LEFT	RIGHT	LEFT
Smith & Wesson 4013, 4014 3.5" BBL	Plain	Black	070-540-161	070-540-162	0705-540-161	0705-540-162
	Basket	Black	070-540-181	070-540-182	0705-540-181	0705-540-182
	Hi Gloss	Black	070-540-91	070-540-92	0705-540-91	0705-540-92
Smith & Wesson 4046 short round trigger guard 4" BBL	Plain	Black	070-240-161	070-240-162	0705-240-161	0705-240-162
	Basket	Black	070-240-181	070-240-182	0705-240-181	0705-240-182
	Hi Gloss	Black	070-240-91	070-240-92	0705-240-91	0705-240-92
Smith & Wesson 4053 3.5" BBL	Plain	Black	070-340-161	070-340-162	0705-340-161	0705-340-162
	Basket	Black	070-340-181	070-340-182	0705-340-181	0705-340-182
	Hi Gloss	Black	070-340-91	070-340-92	0705-340-91	0705-340-92
Smith & Wesson 4516-1, 4516-2 Version II 3.75" BBL, 4513TSW, w/o Rails 3.5" BBL	Plain	Black	070-423-161	070-423-162	0705-423-161	0705-423-162
	Basket	Black	070-423-181	070-423-182	0705-423-181	0705-423-182
	Hi Gloss	Black	070-423-91	070-423-92	0705-423-91	0705-423-92
Smith & Wesson 5946, 6946 4" BBL	Plain	Black	070-218-161	070-218-162	0705-218-161	0705-218-162
	Basket	Black	070-218-181	070-218-182	0705-218-181	0705-218-182
	Hi Gloss	Black	070-218-91	070-218-92	0705-218-91	0705-218-92
Smith & Wesson 4563TSW, 4566TSW, 4586TSW, 4583TSW, w/ Rails 4.25" BBL	Plain	Black	070-430-161	070-430-162	0705-430-161	0705-430-162
	Basket	Black	070-430-181	070-430-182	0705-430-181	0705-430-182
	Hi Gloss	Black	070-430-91	070-430-92	0705-430-91	0705-430-92
Smith & Wesson 4006TSW, 4046TSW, 5906TSW, 5946TSW, w/ Rails 4" BBL	Plain	Black	070-520-161	070-520-162	0705-520-161	0705-520-162
	Basket	Black	070-520-181	070-520-182	0705-520-181	0705-520-182
	Hi Gloss	Black	070-520-91	070-520-92	0705-520-91	0705-520-92
Smith & Wesson 4553TSW, w/ 6 1/2" overall slide length (N/A 4553TSW w/ 6 3/4" overall slide length) 3.75" BBL	Plain	Black	070-610-161	070-610-162	0705-610-161	0705-610-162
	Basket	Black	070-610-181	070-610-182	0705-610-181	0705-610-182
	Hi Gloss	Black	070-610-91	070-610-92	0705-610-91	0705-610-92
Smith & Wesson Sigma 9C, Sigma 40C 4" BBL	Plain	Black	070-39-161	070-39-162	0705-39-161	0705-39-162
	Basket	Black	070-39-181	070-39-182	0705-39-181	0705-39-182
	Hi Gloss	Black	070-39-91	070-39-92	0705-39-91	0705-39-92
Smith & Wesson Sigma 9F, Sigma 40F 4.5" BBL	Plain	Black	070-40-161	070-40-162	0705-40-161	0705-40-162
	Basket	Black	070-40-181	070-40-182	0705-40-181	0705-40-182
	Hi Gloss	Black	070-40-91	070-40-92	0705-40-91	0705-40-92
Smith & Wesson SW99 4" BBL	Plain	Black	070-84-161	070-84-162	0705-84-161	0705-84-162
	Basket	Black	070-84-181	070-84-182	0705-84-181	0705-84-182
	Hi Gloss	Black	070-84-91	070-84-92	0705-84-91	0705-84-92
Springfield Armory 1911-A1 5" BBL	Plain	Black	070-53-161	070-53-162	0705-53-161	0705-53-162
	Basket	Black	070-53-181	070-53-182	0705-53-181	0705-53-182
	Hi Gloss	Black	070-53-91	070-53-92	0705-53-91	0705-53-92
Springfield Armory Operator 1911-A1 w/ Picatinny Light Rail 5" BBL	Plain	Black	070-56-161	070-56-162	0705-56-161	0705-56-162
	Basket	Black	070-56-181	070-56-182	0705-56-181	0705-56-182
	Hi Gloss	Black	070-56-91	070-56-92	0705-56-91	0705-56-92
Taurus PT-92C, PT-99C 4" BBL, PT-92, PT-99 5" BBL	Plain	Black	070-73-161	070-73-162	0705-73-161	0705-73-162
	Basket	Black	070-73-181	070-73-182	0705-73-181	0705-73-182
	Hi Gloss	Black	070-73-91	070-73-92	0705-73-91	0705-73-92
Walther P99 4" BBL	Plain	Black	070-84-161	070-84-162	0705-84-161	0705-84-162
	Basket	Black	070-84-181	070-84-182	0705-84-181	0705-84-182
	Hi Gloss	Black	070-84-91	070-84-92	0705-84-91	0705-84-92



Duty Holsters

070/0705 SSIII™ LEVEL III RETENTION™ HOLSTERS FOR: REVOLVERS



070 MID-RIDE



0705 LOW-RIDE

FEATURES

- ▶ Level III Retention™ holster
- ▶ Slight forward grip cant allow for comfortable carry and quick, easy draw
- ▶ Top thumb break and middle finger release tab, internal ejection port lock
- ▶ For pistols or revolvers
- ▶ Offered for 2.25" (58mm) belt slot only
- ▶ Available in Plain Black, Basketweave, Hi Gloss and Nylon Look finishes
- ▶ Safariland offers training DVDs for various products. For more information on retention levels and this product please review TV-1007D and TV-1023D

*Order Code for Nylon Look finish:
 Replace X with center code and 1 (RH) or 2 (LH)
 Nylon Look 070-XX-26X

GUN DESCRIPTION	FINISH*	COLOR	070 MID-RIDE		0705 LOW-RIDE	
			RIGHT	LEFT	RIGHT	LEFT
Colt Python, King Cobra 4" BBL	Plain	Black	070-105-161	070-105-162	0705-105-161	0705-105-162
	Basket	Black	070-105-181	070-105-182	0705-105-181	0705-105-182
	Hi Gloss	Black	070-105-91	0705-105-92	0705-105-91	0705-105-92
Ruger GP100 4" BBL	Plain	Black	070-105-161	070-105-162	0705-105-161	0705-105-162
	Basket	Black	070-105-181	070-105-182	0705-105-181	0705-105-182
	Hi Gloss	Black	070-105-91	070-105-92	0705-105-91	0705-105-92
Smith & Wesson 10, 12, 13, 15, 19, 64, 65, 66, 67 K Medium Frame, 4" BBL	Plain	Black	070-24-161	070-24-162	0705-24-161	0705-24-162
	Basket	Black	070-24-181	070-24-182	0705-24-181	0705-24-182
	Hi Gloss	Black	070-24-91	070-24-92	0705-24-91	0705-24-92
Smith & Wesson 581, 586, 681, 686 L Medium Frame, 4" BBL	Plain	Black	070-21-161	070-21-162	0705-21-161	0705-21-162
	Basket	Black	070-21-181	070-21-182	0705-21-181	0705-21-182
	Hi Gloss	Black	070-21-91	070-21-92	0705-21-91	0705-21-92
Taurus M-80, M-82 4" BBL	Plain	Black	070-21-161	070-21-162	0705-21-161	0705-21-162
	Basket	Black	070-21-181	070-21-182	0705-21-181	0705-21-182
	Hi Gloss	Black	070-21-91	070-21-92	0705-21-91	0705-21-92

- How to Order
- Duty Holsters
- Duty Accessories
- Tactical Holsters
- Tactical Accessories
- Duty Belts
- QAS
- Speed Loaders
- Light Systems
- Concealment Holsters
- Concealment Accessories
- Competition
- Apparel
- Sales Support
- Index/Price List

Duty Holsters



200/2005 TOP GUN™ LEVEL I RETENTION™ HOLSTERS FOR: PISTOLS



200 MID-RIDE



2005 LOW-RIDE

FEATURES

- ▶ Level I Retention™ holster
- ▶ Features a top draw, straight drop cant and a thumb break with a one-way directional snap
- ▶ Adjustable holster tensioning device easily allows the controlling of friction with the turn of a screw
- ▶ For pistols or revolvers
- ▶ Offered in 2" (50mm) or 2.25" (58mm) belt slots only
- ▶ Available in Plain Black, Basketweave, Hi Gloss and Nylon Look finishes
- ▶ Safariland offers training DVDs for various products. For more information on retention levels please review TV-1007D

*Order code for Nylon Look Finish:
Replace X with center code and 1 (RH) or 2 (LH)
200-XX-26X

GUN DESCRIPTION	FINISH*	COLOR	200 MID-RIDE		2005 LOW-RIDE	
			RIGHT	LEFT	RIGHT	LEFT
AMT Hardballer 5" BBL	Plain	Black	200-53-161	200-53-162	2005-53-161	2005-53-162
	Basket	Black	200-53-181	200-53-182	2005-53-181	2005-53-182
	Hi Gloss	Black	200-53-91	200-53-92	2005-53-91	2005-53-92
Beretta 92D, 92DS, 92F, 92FS, 92G, 96, 96D, 96 S, 96G, 4.9" BBL	Plain	Black	200-73-161	200-73-162	2005-73-161	2005-73-162
	Basket	Black	200-73-181	200-73-182	2005-73-181	2005-73-182
	Hi Gloss	Black	200-73-91	200-73-92	2005-73-91	2005-73-92
Beretta 92FC, 92FCM Compact 92FCDA, 92FS Centurion, 96DC, 96 Centurion, 4.3" BBL	Plain	Black	200-273-161	200-273-162	2005-273-161	2005-273-162
	Basket	Black	200-273-181	200-273-182	2005-273-181	2005-273-182
	Hi Gloss	Black	200-273-91	200-273-92	2005-273-91	2005-273-92
Beretta 8000, 8040 Cougar G, F, D 3.6" BBL	Plain	Black	200-71-161	200-71-162	2005-71-161	2005-71-162
	Basket	Black	200-71-181	200-71-182	2005-71-181	2005-71-182
	Hi Gloss	Black	200-71-91	200-71-92	2005-71-91	2005-71-92
Browning Hi-Power 9mm 4.625" BBL	Plain	Black	200-76-161	200-76-162	2005-76-161	2005-76-162
	Basket	Black	200-76-181	200-76-182	2005-76-181	2005-76-182
	Hi Gloss	Black	200-76-91	200-76-92	2005-76-91	2005-76-92
Colt Combat Elite, Delta Elite Delta Gold Cup, Gold Cup Nat'l Match, Government 1911 5" BBL	Plain	Black	200-53-161	200-53-162	2005-53-161	2005-53-162
	Basket	Black	200-53-181	200-53-182	2005-53-181	2005-53-182
	Hi Gloss	Black	200-53-91	200-53-92	2005-53-91	2005-53-92
Colt Commander 4.25" BBL	Plain	Black	200-51-161	200-51-162	2005-51-161	2005-51-162
	Basket	Black	200-51-181	200-51-182	2005-51-181	2005-51-182
	Hi Gloss	Black	200-51-91	200-51-92	2005-51-91	2005-51-92



Duty Holsters

200/2005 TOP GUN™ LEVEL I RETENTION™ HOLSTERS FOR: PISTOLS

How to Order
 Duty Holsters
 Duty Accessories
 Tactical Holsters
 Tactical Accessories
 Duty Belts
 QAS
 Speed Loaders
 Light Systems
 Concealment Holsters
 Concealment Accessories
 Competition
 Apparel
 Sales Support
 Index/Price List

GUN DESCRIPTION	FINISH*	COLOR	200 MID-RIDE		2005 LOW-RIDE	
			RIGHT	LEFT	RIGHT	LEFT
Glock 17, 22, 4.5" BBL	Plain	Black	200-83-161	200-83-162	2005-83-161	2005-83-162
	Basket	Black	200-83-181	200-83-182	2005-83-181	2005-83-182
	Hi Gloss	Black	200-83-91	200-83-92	2005-83-91	2005-83-92
Glock 17, 22 w/ ITI M3 Light, 4.5" BBL	Plain	Black	200-832-161	200-832-162	2005-832-161	2005-832-162
	Basket	Black	200-832-181	200-832-182	2005-832-181	2005-832-182
	Hi Gloss	Black	200-832-91	200-832-92	2005-832-91	2005-832-92
Glock 20, 21, 4.6" BBL , 29, 30, 3.78" BBL	Plain	Black	200-383-161	200-383-162	2005-383-161	2005-383-162
	Basket	Black	200-383-181	200-383-182	2005-383-181	2005-383-182
	Hi Gloss	Black	200-383-91	200-383-92	2005-383-91	2005-383-92
Glock 34, 35 5.32" BBL	Plain	Black	200-683-161	200-683-162	2005-683-161	2005-683-162
	Basket	Black	200-683-181	200-683-182	2005-683-181	2005-683-182
	Hi Gloss	Black	200-683-91	200-683-92	2005-683-91	2005-683-92
Heckler & Koch P7M8, P7M13 4.1" BBL	Plain	Black	200-82-161	200-82-162	2005-82-161	2005-82-162
	Basket	Black	200-82-181	200-82-182	2005-82-181	2005-82-182
	Hi Gloss	Black	200-82-91	200-82-92	2005-82-91	2005-82-92
Heckler & Koch USP 9C, 40C 3.58" BBL	Plain	Black	200-291-161	200-291-162	2005-291-161	2005-291-162
	Basket	Black	200-291-181	200-291-182	2005-291-181	2005-291-182
	Hi Gloss	Black	200-291-91	200-291-92	2005-291-91	2005-291-92
Heckler & Koch USP 9mm, .40 4.13" BBL	Plain	Black	200-91-161	200-91-162	2005-91-161	2005-91-162
	Basket	Black	200-91-181	200-91-182	2005-91-181	2005-91-182
	Hi Gloss	Black	200-91-91	200-91-92	2005-91-91	2005-91-92
Heckler & Koch USP .45 4.41" BBL	Plain	Black	200-93-161	200-93-162	2005-93-161	2005-93-162
	Basket	Black	200-93-181	200-93-182	2005-93-181	2005-93-182
	Hi Gloss	Black	200-93-91	200-93-92	2005-93-91	2005-93-92
Heckler & Koch HK .45 4.53" BBL	Plain	Black	200-91-161	200-91-162	2005-91-161	2005-91-162
	Basket	Black	200-91-181	200-91-182	2005-91-181	2005-91-182
	Hi Gloss	Black	200-91-91	200-91-92	2005-91-91	2005-91-92
Kimber KIP45CUS 5" BBL	Plain	Black	200-53-161	200-53-162	2005-53-161	2005-53-162
	Basket	Black	200-53-181	200-53-182	2005-53-181	2005-53-182
	Hi Gloss	Black	200-53-91	200-53-92	2005-53-91	2005-53-92
Para-Ordnance P14 5" BBL	Plain	Black	200-53-161	200-53-162	200-53-161	200-53-162
	Basket	Black	200-53-181	200-53-182	200-53-181	200-53-182
	Hi Gloss	Black	200-53-91	200-53-92	200-53-91	200-53-92
Ruger P-85, KP-89, KP-89 DAO, KP-89 DAOW, KP-89 DC, KP-89 DW, KP-89 W, P-89, P-89 DC, P-89 DW, P-89 W, 9mm, 4.5" BBL	Plain	Black	200-67-161	200-67-162	2005-67-161	2005-67-162
	Basket	Black	200-67-181	200-67-182	2005-67-181	2005-67-182
	Hi Gloss	Black	200-67-91	200-67-92	2005-67-91	2005-67-92
Ruger P-90, P-90 DC, KP-90, KP-90 DC, KP-90 W, KP-90 DW, 45 ACP, 4.5" BBL	Plain	Black	200-67-161	200-67-162	2005-67-161	2005-67-162
	Basket	Black	200-67-181	200-67-182	2005-67-181	2005-67-182
	Hi Gloss	Black	200-67-91	200-67-92	2005-67-91	2005-67-92
Ruger KP-91 DC, KP-91 DAO, P-91 DC, P-91 DAO, 40 S&W, 4.5" BBL	Plain	Black	200-67-161	200-67-162	2005-67-161	2005-67-162
	Basket	Black	200-67-181	200-67-182	2005-67-181	2005-67-182
	Hi Gloss	Black	200-67-91	200-67-92	2005-67-91	2005-67-92
Ruger KP-93DC, KP-93 DAO, KP-95 D, KP-95, DAO, P-95 D, P-95, DAO, 3.9" BBL	Plain	Black	200-69-161	200-69-162	2005-69-161	2005-69-162
	Basket	Black	200-69-181	200-69-182	2005-69-181	2005-69-182
	Hi Gloss	Black	200-69-91	200-69-92	2005-69-91	2005-69-92
Ruger KP-94, KP-94 DC, KP-94 DAO 4.25" BBL	Plain	Black	200-69-161	200-69-162	2005-69-161	2005-69-162
	Basket	Black	200-69-181	200-69-182	2005-69-181	2005-69-182
	Hi Gloss	Black	200-69-91	200-69-92	2005-69-91	2005-69-92
Ruger KP-944, KP-944 DAO, KP-944 DAOW, KP-944 DC, KP-944 DW, KP-944 W, 4.2" BBL	Plain	Black	200-69-161	200-69-162	2005-69-161	2005-69-162
	Basket	Black	200-69-181	200-69-182	2005-69-181	2005-69-182
	Hi Gloss	Black	200-69-91	200-69-92	2005-69-91	2005-69-92



Duty Holsters

200/2005 TOP GUN™ LEVEL I RETENTION™ HOLSTERS FOR: PISTOLS (continued)

How to Order	Duty Holsters	GUN DESCRIPTION	FINISH*	COLOR	200 MID-RIDE		2005 LOW-RIDE	
					RIGHT	LEFT	RIGHT	LEFT
Duty Accessories	Ruger SR9 4" BBL	Plain	Black	200-84-161	200-84-162	2005-84-162	2005-84-162	
		Basket	Black	200-84-181	200-84-182	2005-84-181	2005-84-182	
		Hi Gloss	Black	200-84-91	200-84-92	2005-84-91	2005-84-92	
Duty Accessories	Sig Sauer P220, P226, P220R, P226R DA/SA 4.41" BBL	Plain	Black	200-77-161	200-77-162	2005-77-161	2005-77-162	
		Basket	Black	200-77-181	200-77-182	2005-77-181	2005-77-182	
		Hi Gloss	Black	200-77-91	200-77-92	2005-77-91	2005-77-92	
Tactical Holsters	Sig Sauer P220R DAK, P226R DAK Bobbed Hammer 4.41" BBL	Plain	Black	200-277-161	200-277-162	2005-277-161	2005-277-162	
		Basket	Black	200-277-181	200-277-182	2005-277-181	2005-277-182	
		Hi Gloss	Black	200-277-91	200-277-92	2005-277-91	2005-277-92	
Tactical Accessories	Sig Sauer P225, P228, P229 3.9" BBL	Plain	Black	200-74-161	200-74-162	2005-74-161	2005-74-162	
		Basket	Black	200-74-181	200-74-182	2005-74-181	2005-74-182	
		Hi Gloss	Black	200-74-91	200-74-92	2005-74-91	2005-74-92	
Tactical Accessories	Sig Sauer P229R DAK 3.9" BBL	Plain	Black	200-174-161	200-174-162	2005-174-161	2005-174-162	
		Basket	Black	200-174-181	200-174-182	2005-174-181	2005-174-182	
		Hi Gloss	Black	200-174-91	200-174-92	2005-174-91	2005-174-92	
Duty Belts	Sig Sauer P229R DA/SA 3.9" BBL	Plain	Black	200-744-161	200-744-162	2005-744-161	2005-744-162	
		Basket	Black	200-744-181	200-744-182	2005-744-181	2005-744-182	
		Hi Gloss	Black	200-744-91	200-744-92	2005-744-91	2005-744-92	
OAS	Sig Sauer P239 3.625" BBL	Plain	Black	200-75-161	200-75-162	2005-75-161	2005-75-162	
		Basket	Black	200-75-181	200-75-182	2005-75-181	2005-75-182	
		Hi Gloss	Black	200-75-91	200-75-92	2005-75-91	2005-75-92	
Speed Loaders	Sig Sauer Sig Pro SP2340 3.875" BBL	Plain	Black	200-78-161	200-78-162	2005-78-161	2005-78-162	
		Basket	Black	200-78-181	200-78-182	2005-78-181	2005-78-182	
		Hi Gloss	Black	200-78-91	200-78-92	2005-78-91	2005-78-92	
Light Systems	Smith & Wesson 39, 59, 411, 439, 459, 639, 659, 915, 3904, 3906, 4006, 4026, 5903, 5904, 5906, 5923, 5924, 5926, 4" BBL	Plain	Black	200-140-161	200-140-162	2005-140-161	2005-140-162	
		Basket	Black	200-140-181	200-140-182	2005-140-181	2005-140-182	
		Hi Gloss	Black	200-140-91	200-140-92	2005-140-91	2005-140-92	
Light Systems	Smith & Wesson 410 40 S&W, 909, 910 9mm 4" BBL	Plain	Black	200-19-161	200-19-162	2005-19-161	2005-19-162	
		Basket	Black	200-19-181	200-19-182	2005-19-181	2005-19-182	
		Hi Gloss	Black	200-19-91	200-19-92	2005-19-91	2005-19-92	
Concealment Holsters	Smith & Wesson 469, 669, 3913, 3913LS, 3913NL, 3913TSW, 3914, 3914LS, 4013TSW, 6904, 6906, 6924, 6926 3.5" BBL	Plain	Black	200-20-161	200-20-162	2005-20-161	2005-20-162	
		Basket	Black	200-20-181	200-20-182	2005-20-181	2005-20-182	
		Hi Gloss	Black	200-20-91	200-20-92	2005-20-91	2005-20-92	
Concealment Accessories	Smith & Wesson 3953, 3953TSW, 3954, 6946 3.5" BBL 4046, 5946 4" BBL	Plain	Black	200-240-161	200-240-162	2005-240-161	2005-240-162	
		Basket	Black	200-240-181	200-240-182	2005-240-181	2005-240-182	
		Hi Gloss	Black	200-240-91	200-240-92	2005-240-91	2005-240-92	
Concealment Accessories	Smith & Wesson 645, 4506 5" BBL	Plain	Black	200-23-161	200-23-162	2005-23-161	2005-23-162	
		Basket	Black	200-23-181	200-23-182	2005-23-181	2005-23-182	
		Hi Gloss	Black	200-23-91	200-23-92	2005-23-91	2005-23-92	
Competition	Smith & Wesson 1006, 1026, 4506-1, 4526 5" BBL	Plain	Black	200-210-161	200-210-162	2005-210-161	2005-210-162	
		Basket	Black	200-210-181	200-210-182	2005-210-181	2005-210-182	
		Hi Gloss	Black	200-210-91	200-210-92	2005-210-91	2005-210-92	
Apparel	Smith & Wesson 1076, 4576 4.25" BBL	Plain	Black	200-310-161	200-310-162	2005-310-161	2005-310-162	
		Basket	Black	200-310-181	200-310-182	2005-310-181	2005-310-182	
		Hi Gloss	Black	200-310-91	200-310-92	2005-310-91	2005-310-92	
Sales Support	Smith & Wesson 1066, 1086 4.25" BBL, 4053, 4553TSW 3.75" BBL 4566, 4856 short round trigger guard 4.25" BBL	Plain	Black	200-410-161	200-410-162	2005-410-161	2005-410-162	
		Basket	Black	200-410-181	200-410-182	2005-410-181	2005-410-182	
		Hi Gloss	Black	200-410-91	200-410-92	2005-410-91	2005-410-92	



Duty Holsters

200/2005 TOP GUN™ LEVEL I RETENTION™ HOLSTERS FOR: PISTOLS (continued)

How to Order
 Duty Holsters
 Duty Accessories
 Tactical Holsters
 Tactical Accessories
 Duty Belts
 QAS
 Speed Loaders
 Light Systems
 Concealment Holsters
 Concealment Accessories
 Competition
 Apparel
 Sales Support
 Index/Price List

GUN DESCRIPTION	FINISH*	COLOR	200 MID-RIDE		2005 LOW-RIDE	
			RIGHT	LEFT	RIGHT	LEFT
Smith & Wesson 4013 ,4513TSW 3.5" BBL, 4516-1, 4516-2 3.75" BBL 4536 3.75" BBL	Plain	Black	200-423-161	200-423-162	2005-423-161	2005-423-162
	Basket	Black	200-423-181	200-423-182	2005-423-181	2005-423-182
	Hi Gloss	Black	200-423-91	200-423-92	2005-423-91	2005-423-92
Smith & Wesson M&P 9mm, .40 4.25" BBL	Plain	Black	200-619-161	200-619-162	2005-619-161	2005-619-162
	Basket	Black	200-619-181	200-619-182	2005-619-181	2005-619-182
	Hi Gloss	Black	200-619-91	200-619-92	2005-619-91	2005-619-92
Smith & Wesson Sigma 9C, Sigma 40C, SW9V, SW40V, 4" BBL	Plain	Black	200-39-161	200-39-162	2005-39-161	2005-39-162
	Basket	Black	200-39-181	200-39-182	2005-39-181	2005-39-182
	Hi Gloss	Black	200-39-91	200-39-92	2005-39-91	2005-39-92
Smith & Wesson Sigma 9F, Sigma 40F 4.5" BBL	Plain	Black	200-40-161	200-40-162	2005-40-161	2005-40-162
	Basket	Black	200-40-181	200-40-182	2005-40-181	2005-40-182
	Hi Gloss	Black	200-40-91	200-40-92	2005-40-91	2005-40-92
Smith & Wesson SW99 4" BBL	Plain	Black	200-84-161	200-84-162	2005-84-161	2005-84-162
	Basket	Black	200-84-181	200-84-182	2005-84-181	2005-84-182
	Hi Gloss	Black	200-84-91	200-84-92	2005-84-91	2005-84-92
Springfield Armory 1911-A1 5" BBL	Plain	Black	200-53-161	200-53-162	2005-53-161	2005-53-162
	Basket	Black	200-53-181	200-53-182	2005-53-181	2005-53-182
	Hi Gloss	Black	200-53-91	200-53-92	2005-53-91	2005-53-92
Taurus PT-92, PT-99 5" BBL	Plain	Black	200-73-161	200-73-162	2005-73-161	2005-73-162
	Basket	Black	200-73-181	200-73-182	2005-73-181	2005-73-182
	Hi Gloss	Black	200-73-91	200-73-92	2005-73-91	2005-73-92
Taurus PT-92C, PT-99C 4" BBL	Plain	Black	200-273-161	200-273-162	2005-273-161	2005-273-162
	Basket	Black	200-273-181	200-273-182	2005-273-181	2005-273-182
	Hi Gloss	Black	200-273-91	200-273-92	2005-273-91	2005-273-92
Walther P5 3.5" BBL	Plain	Black	200-87-161	200-87-162	2005-87-161	2005-87-162
	Basket	Black	200-87-181	200-87-182	2005-87-181	2005-87-182
	Hi Gloss	Black	200-87-91	200-87-92	2005-87-91	2005-87-92
Walther P99 4" BBL	Plain	Black	200-84-161	200-84-162	2005-84-161	2005-84-162
	Basket	Black	200-84-181	200-84-182	2005-84-181	2005-84-182
	Hi Gloss	Black	200-84-91	200-84-92	2005-84-91	2005-84-92
Walther P99C QA 3.375" BBL	Plain	Black	200-84-161	200-84-162	2005-84-161	2005-84-162
	Basket	Black	200-84-181	200-84-182	2005-84-181	2005-84-182
	Hi Gloss	Black	200-84-91	200-84-92	2005-84-91	2005-84-92

Duty Holsters



200/2005 TOP GUN™ LEVEL I RETENTION™ HOLSTERS FOR: REVOLVERS



200 MID-RIDE



2005 LOW-RIDE

FEATURES

- ▶ Level I Retention™ holster
- ▶ Features a top draw, mid-ride, straight drop cant and a thumb break with a oneway directional snap
- ▶ Adjustable holster tensoning device easily allows the controlling of friction with the turn of a screw
- ▶ Offered in 2" (50mm) or 2.25" (58mm) belt slots only
- ▶ For revolvers

- ▶ Available in Plain Black, Basketweave, Hi Gloss and Nylon Look finishes
- ▶ Safariland offers training DVDs for various products. For more information on retention levels this please review TV-1007D

* Order code for Nylon Look Finish:
Replace X with center code and 1 (RH) or 2 (LH)
Nylon Look: 200-XX-26X

GUN DESCRIPTION	FINISH*	COLOR	200 MID-RIDE		2005 LOW-RIDE	
			RIGHT	LEFT	RIGHT	LEFT
Colt Python, King Cobra Trooper, 4" BBL	Plain	Black	200-21-161	200-21-162	2005-21-161	2005-21-162
	Basket	Black	200-21-181	200-21-182	2005-21-181	2005-21-182
	Hi Gloss	Black	200-21-91	200-21-92	2005-21-91	2005-21-92
Colt Python, King Cobra 6" BBL	Plain	Black	200-621-161	200-621-162	2005-621-161	2005-621-162
	Basket	Black	200-621-181	200-621-182	2005-621-181	2005-621-182
	Hi Gloss	Black	200-621-91	200-621-92	2005-621-91	2005-621-92
Ruger GP100 4" BBL	Plain	Black	200-21-161	200-21-162	2005-21-161	2005-21-162
	Basket	Black	200-21-181	200-21-182	2005-21-181	2005-21-182
	Hi Gloss	Black	200-21-91	200-21-92	2005-21-91	2005-21-92
Ruger Security Six, Service Six, Speed Six 4" BBL	Plain	Black	200-09-161	200-09-162	2005-09-161	2005-09-162
	Basket	Black	200-09-181	200-09-182	2005-09-181	2005-09-182
	Hi Gloss	Black	200-09-91	200-09-92	2005-09-91	2005-09-92
Ruger GP100 6" BBL	Plain	Black	200-621-161	200-621-162	2005-621-161	2005-621-162
	Basket	Black	200-621-181	200-621-182	2005-621-181	2005-621-182
	Hi Gloss	Black	200-621-91	200-621-92	2005-621-91	2005-621-92
Smith & Wesson 10, 12, 13, 15, 19, 64, 65, 66, 67, 617, 648, K Medium Frame, 4" BBL	Plain	Black	200-09-161	200-09-162	2005-09-161	2005-09-162
	Basket	Black	200-09-181	200-09-182	2005-09-181	2005-09-182
	Hi Gloss	Black	200-09-91	200-09-92	2005-09-91	2005-09-92
Smith & Wesson 581, 586, 681, 686 L Medium Frame, 4" BBL	Plain	Black	200-21-161	200-21-162	2005-21-161	2005-21-162
	Basket	Black	200-21-181	200-21-182	2005-21-181	2005-21-182
	Hi Gloss	Black	200-21-91	200-21-92	2005-21-91	2005-21-92
Smith & Wesson 586, 686 L Medium Frame, 6" BBL	Plain	Black	200-621-161	200-621-162	2005-621-161	2005-621-162
	Basket	Black	200-621-181	200-621-182	2005-621-181	2005-621-182
	Hi Gloss	Black	200-621-91	200-621-92	2005-621-91	2005-621-92
Taurus 66, 669, 689, M-80, M-82 4" BBL	Plain	Black	200-21-161	200-21-162	2005-21-161	2005-21-162
	Basket	Black	200-21-181	200-21-182	2005-21-181	2005-21-182
	Hi Gloss	Black	200-21-91	200-21-92	2005-21-91	2005-21-92
Taurus 66, 669, 689 6" BBL	Plain	Black	200-621-161	200-621-162	2005-621-161	2005-621-162
	Basket	Black	200-621-181	200-621-182	2005-621-181	2005-621-182
	Hi Gloss	Black	200-621-91	200-621-92	2005-621-91	2005-621-92



Duty Holsters

295/2955 LEVEL II RETENTION™ HOLSTER FOR: PISTOLS



295 MID-RIDE



2955 LOW-RIDE

FEATURES

- ▶ Level II Retention™ holster
- ▶ Features front wraparound thumb break and an internal trigger guard lock for secure weapon retention
- ▶ Slight forward grip cant allow for comfortable carry and quick, easy draw
- ▶ Available for double-action only pistols; not recommended for single-action or conventional double-action pistols
- ▶ Not available for revolvers
- ▶ Offered in 2" (50mm) or 2.25" (58mm) belt slots
- ▶ Available in Plain Black, Basketweave, Hi Gloss and Nylon Look finishes
- ▶ Safariland offers training DVDs for various products. For more information on retention levels please review TV-1007D

* Order code for Nylon Look Finish:
 Replace X with center code and 1 (RH) or 2 (LH)
 Nylon Look: 295-XX-26X

GUN DESCRIPTION	FINISH*	COLOR	295 MID-RIDE		2955 LOW-RIDE	
			RIGHT	LEFT	RIGHT	LEFT
Glock 17, 22 4.5" BBL 19, 23 4" BBL	Plain	Black	295-83-61	295-83-62	2955-83-61	2955-83-62
	Basket	Black	295-83-81	295-83-82	2955-83-81	2955-83-82
	Hi Gloss	Black	295-83-91	295-83-92	2955-83-91	2955-83-92
Glock 20, 21 4.6" BBL 29, 30 3.78" BBL	Plain	Black	295-383-61	295-383-62	2955-383-61	2955-383-62
	Basket	Black	295-383-81	295-383-82	2955-383-81	2955-383-82
	Hi Gloss	Black	295-383-91	295-383-92	2955-383-91	2955-383-92
Smith & Wesson 3953, 3953TSW, 6946 3.5" BBL 5946 DAO All w/ fixed Novak sights 4" BBL	Plain	Black	295-420-61	295-420-62	2955-420-61	2955-420-62
	Basket	Black	295-420-81	295-420-82	2955-420-81	2955-420-82
	Hi Gloss	Black	295-420-91	295-420-92	2955-420-91	2955-420-92

- How to Order
- Duty Holsters
- Duty Accessories
- Tactical Holsters
- Tactical Accessories
- Duty Belts
- QAS
- Speed Loaders
- Light Systems
- Concealment Holsters
- Concealment Accessories
- Competition
- Apparel
- Sales Support
- Index/Price List

How to Order
Duty Holsters
Duty Accessories
Tactical Holsters
Tactical Accessories
Duty Belts
OAS
Speed Loaders
Light Systems
Concealment Holsters
Concealment Accessories
Competition
Apparel
Sales Support
Index/Price List

Duty Holsters



6280/6282/6285 SLS LEVEL II RETENTION™ HOLSTERS FOR: PISTOLS



6280 MID-RIDE



6282 HI-RIDE



6285 LOW-RIDE

FEATURES

- ▶ Level II Retention™ holster
- ▶ SLS (Self Locking System) Rotating Hood
- ▶ Top draw and straight drop cant
- ▶ Level III Retention™ with optional Sentry installed
- ▶ Offered for weapons with and without rail mounted lights
- ▶ Offered in 2" (50mm) or 2.25" (58mm) belt slots
- ▶ Available in Plain Black, Basketweave, Hi Gloss, Nylon Look, STX finishes and STX Tactical® (all colors)
- ▶ Safariland offers training DVDs for various products. For more information on retention levels and this product please review TV-1004D, TV-1007D and TV-1015D

*For these additional STX finishes:
 Sample Code 6280-83-411
 STX Plain 6280-XX-41X
 STX Basket 6280-XX-48X
 STX Hi Gloss 6280-XX-49X
 Nylon Look 6280-XX-26X

Sample Code with Hood Guard installed:
 6280-73-61-H
 Sample Code with Sentry installed:
 6280-73-61-S
 Sample Code with Hood Guard/Sentry installed:
 6280-73-61-SH

6000

6001

6002

Safariland offers three uniquely designed accessories for the SLS holster system, the 6000 hood Guard, the 6001 Sentry (converting the holster to a higher level of security) and the 6002 hood guard/Sentry combination. Available for SLS models including 6004, 6005, 6034, 6035, 6230, 6235, 6280, 6282, 6285, 6287, 7004, 7005, 7280, 7282, and the 7285. ALS Series SLS holsters including the 6360, 6362, 6365, 6304, 6305, 6367, 7304, 7305, 7360, 7362, and the 7365.



Duty Holsters

6280/6282/6285 SLS LEVEL II RETENTION™ HOLSTERS FOR: PISTOLS

GUN DESCRIPTION	FINISH*	COLOR	6280 MID-RIDE		6282 HI-RIDE		6285 LOW-RIDE	
			RIGHT	LEFT	RIGHT	LEFT	RIGHT	LEFT
AMT Hardballer 5" BBL	Plain	Black	6280-53-61	6280-53-62	6282-53-61	6282-53-62	6285-53-61	6285-53-62
	Basket	Black	6280-53-81	6280-53-82	6282-53-81	6282-53-82	6285-53-81	6285-53-82
	Hi Gloss	Black	6280-53-91	6280-53-92	6282-53-91	6282-53-92	6285-53-91	6285-53-92
	STX Tactical	Black	6280-53-131	6280-53-132	6282-53-131	6282-53-132	6285-53-131	6285-53-132
Beretta 84FS Cheetah 3.8" BBL	Plain	Black	6280-62-61	6280-62-62	6282-62-61	6282-62-62	6285-62-61	6285-62-62
	Basket	Black	6280-62-81	6280-62-82	6282-62-81	6282-62-82	6285-62-81	6285-62-82
	Hi Gloss	Black	6280-62-91	6280-62-92	6282-62-91	6282-62-92	6285-62-91	6285-62-92
	STX Tactical	Black	6280-62-131	6280-62-132	6282-62-131	6282-62-132	6285-62-131	6285-62-132
Beretta Px4 Storm 9mm, .40 4" BBL	Plain	Black	6280-180-61	6280-180-62	6282-180-61	6282-180-62	6285-180-61	6285-180-62
	Basket	Black	6280-180-81	6280-180-82	6282-180-81	6282-180-82	6285-180-81	6285-180-82
	Hi Gloss	Black	6280-180-91	6280-180-92	6282-180-91	6282-180-92	6285-180-91	6285-180-92
	STX Tactical	Black	6280-180-131	6280-180-132	6282-180-131	6282-180-132	6285-180-131	6285-180-132
Beretta Px4 Storm 9mm, .40 w/o ITI M3/M6, TLR-1/TLR-2, Insight XT1 Procyon, SureFire X200/X300/X300U 4" BBL	Plain	Black	6280-18021-61	6280-18021-62	6282-18021-61	6282-18021-62	6285-18021-61	6285-18021-62
	Basket	Black	6280-18021-81	6280-18021-82	6282-18021-81	6282-18021-82	6285-18021-81	6285-18021-82
	Hi Gloss	Black	6280-18021-91	6280-18021-92	6282-18021-91	6282-18021-92	6285-18021-91	6285-18021-92
	STX Tactical	Black	6280-18021-131	6280-18021-132	6282-18021-131	6282-18021-132	6285-18021-131	6285-18021-132
Beretta 8000, 8040 Cougar G, F, 8045F, 3.6" BBL	Plain	Black	6280-71-61	6280-71-62	6282-71-61	6282-71-62	6285-71-61	6285-71-62
	Basket	Black	6280-71-81	6280-71-82	6282-71-81	6282-71-82	6285-71-81	6285-71-82
	Hi Gloss	Black	6280-71-91	6280-71-92	6282-71-91	6282-71-92	6285-71-91	6285-71-92
	STX Tactical	Black	6280-71-131	6280-71-132	6282-71-131	6282-71-132	6285-71-131	6285-71-132
Beretta 8000, 8040 Cougar D Double Action Only 3.6" BBL	Plain	Black	6280-171-61	6280-171-62	6282-171-61	6282-171-62	6285-171-61	6285-171-62
	Basket	Black	6280-171-81	6280-171-82	6282-171-81	6282-171-82	6285-171-81	6285-171-82
	Hi Gloss	Black	6280-171-91	6280-171-92	6282-171-91	6282-171-92	6285-171-91	6285-171-92
	STX Tactical	Black	6280-171-131	6280-171-132	6282-171-131	6282-171-132	6285-171-131	6285-171-132
Beretta 92 Brigadier FS, 96 Brigadier, 96 Brigadier G, 92F, 92FS, 92G, 96, 96G 4.9" BBL 92FC, 92FCM, 92FS Centurion, 96 CenturionN/A for D.A. Only 4.3" BBL	Plain	Black	6280-73-61	6280-73-62	6282-73-61	6282-73-62	6285-73-61	6285-73-62
	Basket	Black	6280-73-81	6280-73-82	6282-73-81	6282-73-82	6285-73-81	6285-73-82
	Hi Gloss	Black	6280-73-91	6280-73-92	6282-73-91	6282-73-92	6285-73-91	6285-73-92
	STX Tactical	Black	6280-73-131	6280-73-132	6282-73-131	6282-73-132	6285-73-131	6285-73-132
Beretta 92D, 92DS, 92DM, 96D, 96DS Brigadier D, Double Action Only- Spurless Hammer 4.9" BBL	Plain	Black	6280-173-61	6280-173-62	6282-173-61	6282-173-62	6285-173-61	6285-173-62
	Basket	Black	6280-173-81	6280-173-82	6282-173-81	6282-173-82	6285-173-81	6285-173-82
	Hi Gloss	Black	6280-173-91	6280-173-92	6282-173-91	6282-173-92	6285-173-91	6285-173-92
	STX Tactical	Black	6280-173-131	6280-173-132	6282-173-131	6282-173-132	6285-173-131	6285-173-132
Beretta 92F, 92FS, 92G, 92 Brigadier w/ SureFire P116 4.9" BBL	Plain	Black	6280-736-61	6280-736-62	6282-736-61	6282-736-62	6285-736-61	6285-736-62
	Basket	Black	6280-736-81	6280-736-82	6282-736-81	6282-736-82	6285-736-81	6285-736-82
	Hi Gloss	Black	6280-736-91	6280-736-92	6282-736-91	6282-736-92	6285-736-91	6285-736-92
	STX Tactical	Black	6280-736-131	6280-736-132	6282-736-131	6282-736-132	6285-736-131	6285-736-132
Beretta 92FS, 92G, 96 w/ OC Delivery System 4.9" BBL	Plain	Black	6280-732-61	6280-732-62	6282-732-61	6282-732-62	6285-732-61	6285-732-62
	Basket	Black	6280-732-81	6280-732-82	6282-732-81	6282-732-82	6285-732-81	6285-732-82
	Hi Gloss	Black	6280-732-91	6280-732-92	6282-732-91	6282-732-92	6285-732-91	6285-732-92
	STX Tactical	Black	6280-732-131	6280-732-132	6282-732-131	6282-732-132	6285-732-131	6285-732-132
Beretta 92F, w/ ITI Mount, ITI M3/M6 4.9" BBL	Plain	Black	6280-7321-61	6280-7321-62	6282-7321-61	6282-7321-62	6285-7321-61	6285-7321-62
	Basket	Black	6280-7321-81	6280-7321-82	6282-7321-81	6282-7321-82	6285-7321-81	6285-7321-82
	Hi Gloss	Black	6280-7321-91	6280-7321-92	6282-7321-91	6282-7321-92	6285-7321-91	6285-7321-92
	STX Tactical	Black	6280-7321-131	6280-7321-132	6282-7321-131	6282-7321-132	6285-7321-131	6285-7321-132
Beretta 92, 96 Vertec w/ ITI M3/M6 4.7" BBL	Plain	Black	6280-73421-61	6280-73421-62	6282-73421-61	6282-62-62	6285-62-61	6285-62-62
	Basket	Black	6280-73421-81	6280-73421-82	6282-73421-81	6282-62-82	6285-62-81	6285-62-82
	Hi Gloss	Black	6280-73421-91	6280-73421-92	6282-73421-91	6282-62-92	6285-62-91	6285-62-92
	STX Tactical	Black	6280-73421-131	6280-73421-132	6282-73421-131	6282-62-132	6285-62-131	6285-62-132
Beretta 92, 96 Vertec w/ SureFire Nitrolon P001 Light; N/A for Double Action w/ Bobbed Hammer 4.7" BBL	Plain	Black	6280-7346-61	6280-7346-62	6282-73421-61	6282-73421-62	6285-73421-61	6285-73421-62
	Basket	Black	6280-7346-81	6280-7346-82	6282-73421-81	6282-73421-82	6285-73421-81	6285-73421-82
	Hi Gloss	Black	6280-7346-91	6280-7346-92	6282-73421-91	6282-73421-92	6285-73421-91	6285-73421-92
	STX Tactical	Black	6280-7346-131	6280-7346-132	6282-73421-131	6282-73421-132	6285-73421-131	6285-73421-132
Browning Hi-Power 9mm Canadian Version 4" BBL	Plain	Black	6280-376-61	6280-376-62	6282-376-61	6282-376-62	6285-376-61	6285-376-62
	Basket	Black	6280-376-81	6280-376-82	6282-376-81	6282-376-82	6285-376-81	6285-376-82
	Hi Gloss	Black	6280-376-91	6280-376-92	6282-376-91	6282-376-92	6285-376-91	6285-376-92
	STX Tactical	Black	6280-376-131	6280-376-132	6282-376-131	6282-376-132	6285-376-131	6285-376-132

How to Order
Duty Holsters
Duty Accessories
Tactical Holsters
Tactical Accessories
Duty Bats
QAS
Speed Loaders
Light Systems
Concealment Holsters
Concealment Accessories
Competition
Apparel
Sales Support
Index/Price List



Duty Holsters

6280/6282/6285 SLS LEVEL II RETENTION™ HOLSTERS FOR: PISTOLS (continued)

How to Order
 Duty Holsters
 Duty Accessories
 Tactical Holsters
 Tactical Accessories
 Duty Belts
 QAS
 Speed Loaders
 Light Systems
 Concealment Holsters
 Concealment Accessories
 Competition
 Apparel
 Sales Support
 Index/Price List

GUN DESCRIPTION	FINISH*	COLOR	6280 MID-RIDE		6282 HI-RIDE		6285 LOW-RIDE	
			RIGHT	LEFT	RIGHT	LEFT	RIGHT	LEFT
Browning Hi-Power 9mm Note: To be carried w/ Hammer Down 4.6" BBL	Plain	Black	6280-1376-61	6280-1376-62	6282-1376-61	6282-1376-62	6285-1376-61	6285-1376-62
	Basket	Black	6280-1376-81	6280-1376-82	6282-1376-81	6282-1376-82	6285-1376-81	6285-1376-82
	Hi Gloss	Black	6280-1376-91	6280-1376-92	6282-1376-91	6282-1376-92	6285-1376-91	6285-1376-92
	STX Tactical	Black	6280-1376-131	6280-1376-132	6282-1376-131	6282-1376-132	6285-1376-131	6285-1376-132
Browning Hi-Power 9mm 4.625" BBL	Plain	Black	6280-76-61	6280-76-62	6280-76-61	6282-76-62	6280-76-61	6285-76-62
	Basket	Black	6280-76-81	6280-76-82	6282-76-81	6282-76-82	6285-76-81	6285-76-82
	Hi Gloss	Black	6280-76-91	6280-76-92	6282-76-91	6282-76-92	6285-76-91	6285-76-92
	STX Tactical	Black	6280-76-131	6280-76-132	6282-76-131	6282-76-132	6285-76-131	6285-76-132
Colt Combat Elite, Delta Elite, Delta Gold Cup, Gold Cup Nat'l Match, Government 1911 5" BBL	Plain	Black	6280-53-61	6280-53-62	6280-53-61	6282-53-62	6280-53-61	6285-53-62
	Basket	Black	6280-53-81	6280-53-82	6282-53-81	6282-53-82	6285-53-81	6285-53-82
	Hi Gloss	Black	6280-53-91	6280-53-92	6282-53-91	6282-53-92	6285-53-91	6285-53-92
	STX Tactical	Black	6280-53-131	6280-53-132	6282-53-131	6282-53-132	6285-53-131	6285-53-132
Colt M45A1 COBP 5" BBL	Plain	Black	6280-056-61	6280-056-62	6282-056-61	6282-056-62	6285-056-61	6285-056-62
	Basket	Black	6280-056-81	6280-056-82	6282-056-81	6282-056-82	6285-056-81	6285-056-82
	Hi Gloss	Black	6280-056-91	6280-056-92	6282-056-91	6282-056-92	6285-056-91	6285-056-92
	STX Tactical	Black	6280-056-131	6280-056-132	6282-056-131	6282-056-132	6285-056-131	6285-056-132
Colt 1911-A1, Non Rail, w/ SureFire Mount MR07 w/ SureFire X200/X300/X300U 5" BBL	Plain	Black	6280-530-61	6280-530-62	6280-530-61	6282-530-62	6280-530-61	6285-530-62
	Basket	Black	6280-530-81	6280-530-82	6282-530-81	6282-530-82	6285-530-81	6285-530-82
	Hi Gloss	Black	6280-530-91	6280-530-92	6282-530-91	6282-530-92	6285-530-91	6285-530-92
	STX Tactical	Black	6280-530-131	6280-530-132	6282-530-131	6282-530-132	6285-530-131	6285-530-132
CZ 75B 4.5" BBL	Plain	Black	6280-90-61	6280-90-62	6282-90-61	6282-90-62	6285-90-61	6285-90-62
	Basket	Black	6280-90-81	6280-90-82	6282-90-81	6282-90-82	6285-90-81	6285-90-82
	Hi Gloss	Black	6280-90-91	6280-90-92	6282-90-91	6282-90-92	6285-90-91	6285-90-92
	STX Tactical	Black	6280-90-131	6280-90-132	6282-90-131	6282-90-132	6285-90-131	6285-90-132
FN FNP 9mm 4" BBL	Plain	Black	6280-260-61	6280-260-62	6282-260-61	6282-260-62	6285-260-61	6285-260-62
	Basket	Black	6280-260-81	6280-260-82	6282-260-81	6282-260-82	6285-260-81	6285-260-82
	Hi Gloss	Black	6280-260-91	6280-260-92	6282-260-91	6282-260-92	6285-260-91	6285-260-92
	STX Tactical	Black	6280-260-131	6280-260-132	6282-260-131	6282-260-132	6285-260-131	6285-260-132
FN FNP .45 4.5" BBL	Plain	Black	6280-261-61	6280-261-62	6282-261-61	6282-261-62	6285-261-61	6285-261-62
	Basket	Black	6280-261-81	6280-261-82	6282-261-81	6282-261-82	6285-261-81	6285-261-82
	Hi Gloss	Black	6280-261-91	6280-261-92	6282-261-91	6282-261-92	6285-261-91	6285-261-92
	STX Tactical	Black	6280-261-131	6280-261-132	6282-261-131	6282-261-132	6285-261-131	6285-261-132
FN FNS 9mm, .40 4" BBL	Plain	Black	6280-266-61	6280-266-62	6282-266-61	6282-266-62	6285-266-61	6285-266-62
	Basket	Black	6280-266-81	6280-266-82	6282-266-81	6282-266-82	6285-266-81	6285-266-82
	Hi Gloss	Black	6280-266-91	6280-266-92	6282-266-91	6282-266-92	6285-266-91	6285-266-92
	STX Tactical	Black	6280-266-131	6280-266-132	6282-266-131	6282-266-132	6285-266-131	6285-266-132
FN FNX 9mm, .40 4" BBL	Plain	Black	6280-265-61	6280-265-62	6282-265-61	6282-265-62	6285-265-61	6285-265-62
	Basket	Black	6280-265-81	6280-265-82	6282-265-81	6282-265-82	6285-265-81	6285-265-82
	Hi Gloss	Black	6280-265-91	6280-265-92	6282-265-91	6282-265-92	6285-265-91	6285-265-92
	STX Tactical	Black	6280-265-131	6280-265-132	6282-265-131	6282-265-132	6285-265-131	6285-265-132
FN Five-Seven 4.8" BBL	Plain	Black	6280-61-61	6280-61-62	6282-61-61	6282-61-62	6285-61-61	6285-61-62
	Basket	Black	6280-61-81	6280-61-82	6282-61-81	6282-61-82	6285-61-81	6285-61-82
	Hi Gloss	Black	6280-61-91	6280-61-92	6282-61-91	6282-61-92	6285-61-91	6285-61-92
	STX Tactical	Black	6280-61-131	6280-61-132	6282-61-131	6282-61-132	6285-61-131	6285-61-132
FN Five-Seven w/ ITI M3/M6 (N/A for M3X/M6X) 4.8" BBL	Plain	Black	6280-6121-61	6280-6121-62	6282-6121-61	6282-6121-62	6285-6121-61	6285-6121-62
	Basket	Black	6280-6121-81	6280-6121-82	6282-6121-81	6282-6121-82	6285-6121-81	6285-6121-82
	Hi Gloss	Black	6280-6121-91	6280-6121-92	6282-6121-91	6282-6121-92	6285-6121-91	6285-6121-92
	STX Tactical	Black	6280-6121-131	6280-6121-132	6282-6121-131	6282-6121-132	6285-6121-131	6285-6121-132
Glock 17, 22 4.5" BBL	Plain	Black	6280-83-61	6280-83-62	6280-83-61	6282-83-62	6280-83-61	6285-83-62
	Basket	Black	6280-83-81	6280-83-82	6282-83-81	6282-83-82	6285-83-81	6285-83-82
	Hi Gloss	Black	6280-83-91	6280-83-92	6282-83-91	6282-83-92	6285-83-91	6285-83-92
	STX Tactical	Black	6280-83-131	6280-83-132	6282-83-131	6282-83-132	6285-83-131	6285-83-132
Glock 17, 22 w/ Dual Magazine Release 4.5" BBL	Plain	Black	6280-983-61	6280-983-62	6280-983-61	6282-983-62	6280-983-61	6285-983-62
	Basket	Black	6280-983-81	6280-983-82	6282-983-81	6282-983-82	6285-983-81	6285-983-82
	Hi Gloss	Black	6280-983-91	6280-983-92	6282-983-91	6282-983-92	6285-983-91	6285-983-92
	STX Tactical	Black	6280-983-131	6280-983-132	6282-983-131	6282-983-132	6285-983-131	6285-983-132
Glock 17, 22 w/ Dual Magazine Release w/ ITI M3 Light 4.5" BBL	Plain	Black	6280-9832-61	6280-9832-62	6280-9832-61	6282-9832-62	6280-9832-61	6285-9832-62
	Basket	Black	6280-9832-81	6280-9832-82	6282-9832-81	6282-9832-82	6285-9832-81	6285-9832-82
	Hi Gloss	Black	6280-9832-91	6280-9832-92	6282-9832-91	6282-9832-92	6285-9832-91	6285-9832-92
	STX Tactical	Black	6280-9832-131	6280-9832-132	6282-9832-131	6282-9832-132	6285-9832-131	6285-9832-132
Glock 17, 22 w/ Dual Magazine Release/ GTL 10 light only GTL 21/22 Light/Laser Combination GTL 51/52 Light/Laser Combination 4.5" BBL	Plain	Black	6280-98310-61	6280-98310-62	6282-98310-61	6282-98310-62	6285-98310-61	6285-98310-62
	Basket	Black	6280-98310-81	6280-98310-82	6282-98310-81	6282-98310-82	6285-98310-81	6285-98310-82
	Hi Gloss	Black	6280-98310-91	6280-98310-92	6282-98310-91	6282-98310-92	6285-98310-91	6285-98310-92
	STX Tactical	Black	6280-98310-131	6280-98310-132	6282-98310-131	6282-98310-132	6285-98310-131	6285-98310-132



Duty Holsters

6280/6282/6285 SLS LEVEL II RETENTION™ HOLSTERS FOR: PISTOLS (continued)

GUN DESCRIPTION	FINISH*	COLOR	6280 MID-RIDE		6282 HI-RIDE		6285 LOW-RIDE	
			RIGHT	LEFT	RIGHT	LEFT	RIGHT	LEFT
Glock 17, 22 w/ SureFire P 111, P 111C, P 111D w/ trigger guard mount installed on handgun 4.5" BBL	Plain	Black	6280-830-61	6280-830-62	6282-830-61	6282-830-62	6285-830-61	6285-830-62
	Basket	Black	6280-830-81	6280-830-82	6282-830-81	6282-830-82	6285-830-81	6285-830-82
	Hi Gloss	Black	6280-830-91	6280-830-92	6282-830-91	6282-830-92	6285-830-91	6285-830-92
	STX Tactical	Black	6280-830-131	6280-830-132	6282-830-131	6282-830-132	6285-830-131	6285-830-132
Glock 17, 22 w/ GTL 10 Light only, GTL 21/22 Light/Laser Combination, GTL 51/52 Light/Laser Combination 4.5" BBL	Plain	Black	6280-8310-61	6280-8310-62	6282-8310-61	6282-8310-62	6285-8310-61	6285-8310-62
	Basket	Black	6280-8310-81	6280-8310-82	6282-8310-81	6282-8310-82	6285-8310-81	6285-8310-82
	Hi Gloss	Black	6280-8310-91	6280-8310-92	6282-8310-91	6282-8310-92	6285-8310-91	6285-8310-92
	STX Tactical	Black	6280-8310-131	6280-8310-132	6282-8310-131	6282-8310-132	6285-8310-131	6285-8310-132
Glock 17, 22 ITI w/ M3X/M6X 4.5" BBL	Plain	Black	6280-8312-61	6280-8312-62	6282-8312-61	6282-8312-62	6285-8312-61	6285-8312-62
	Basket	Black	6280-8312-81	6280-8312-82	6282-8312-81	6282-8312-82	6285-8312-81	6285-8312-82
	Hi Gloss	Black	6280-8312-91	6280-8312-92	6282-8312-91	6282-8312-92	6285-8312-91	6285-8312-92
	STX Tactical	Black	6280-8312-131	6280-8312-132	6282-8312-131	6282-8312-132	6285-8312-131	6285-8312-132
Glock 17, 22 w/ ITI M3, TLR-1, SureFire X200, X300 4.5" BBL	Plain	Black	6280-832-61	6280-832-62	6282-832-61	6282-832-62	6285-832-61	6285-832-62
	Basket	Black	6280-832-81	6280-832-82	6282-832-81	6282-832-82	6285-832-81	6285-832-82
	Hi Gloss	Black	6280-832-91	6280-832-92	6282-832-91	6282-832-92	6285-832-91	6285-832-92
	STX Tactical	Black	6280-832-131	6280-832-132	6282-832-131	6282-832-132	6285-832-131	6285-832-132
Glock 17, 22, 31 w/M3, M6, TLR-1, TLR-2 4.5" BBL	Plain	Black	6280-8321-61	6280-8321-62	6282-8321-61	6282-8321-62	6285-8321-61	6285-8321-62
	Basket	Black	6280-8321-81	6280-8321-82	6282-8321-81	6282-8321-82	6285-8321-81	6285-8321-82
	Hi-Gloss	Black	6280-8321-91	6280-8321-92	6282-8321-91	6282-8321-92	6285-8321-91	6285-8321-92
	STX Tactical	Black	6280-8321-131	6280-8321-132	6282-8321-131	6282-8321-132	6285-8321-131	6285-8321-132
Glock 17, 22 w/ ITI Lam Unit 4.5" BBL	Plain	Black	6280-835-61	6280-835-62	6282-835-61	6282-835-62	6285-835-61	6285-835-62
	Basket	Black	6280-835-81	6280-835-82	6282-835-81	6282-835-82	6285-835-81	6285-835-82
	Hi Gloss	Black	6280-835-91	6280-835-92	6282-835-91	6282-835-92	6285-835-91	6285-835-92
	STX Tactical	Black	6280-835-131	6280-835-132	6282-835-131	6282-835-132	6285-835-131	6285-835-132
Glock 17, 22 w/ SureFire X200/X300/X300U 4.5 BBL	Plain	Black	6280-836-61	6280-836-62	6282-836-61	6282-836-62	6285-836-61	6285-836-62
	Basket	Black	6280-836-81	6280-836-82	6282-836-81	6282-836-82	6285-836-81	6285-836-82
	Hi Gloss	Black	6280-836-91	6280-836-92	6282-836-91	6282-836-92	6285-836-91	6285-836-92
	STX Tactical	Black	6280-836-131	6280-836-132	6282-836-131	6282-836-132	6285-836-131	6285-836-132
Glock 17, 22 w/ SureFire X400/X400U 4.5" BBL 19, 23 w/ SureFire X400/X400U 4" BBL	Plain	Black	6280-8314-61	6280-8314-62	6282-8314-61	6282-8314-62	6285-8314-61	6285-8314-62
	Basket	Black	6280-8314-81	6280-8314-82	6282-8314-81	6282-8314-82	6285-8314-81	6285-8314-82
	Hi Gloss	Black	6280-8314-91	6280-8314-92	6282-8314-91	6282-8314-92	6285-8314-91	6285-8314-92
	STX Tactical	Black	6280-8314-131	6280-8314-132	6282-8314-131	6282-8314-132	6285-8314-131	6285-8314-132
Glock 19, 23 4" BBL 26, 27 3.5" BBL 36 3.75" BBL	Plain	Black	6280-283-61	6280-283-62	6282-283-61	6282-283-62	6285-283-61	6285-283-62
	Basket	Black	6280-283-81	6280-283-82	6282-283-81	6282-283-82	6285-283-81	6285-283-82
	Hi Gloss	Black	6280-283-91	6280-283-92	6282-283-91	6282-283-92	6285-283-91	6285-283-92
	STX Tactical	Black	6280-283-131	6280-283-132	6282-283-131	6282-283-132	6285-283-131	6285-283-132
Glock 19, 23 w/ Dual Magazine Release 4" BBL	Plain	Black	6280-9283-61	6280-9283-62	6282-9283-61	6282-9283-62	6285-9283-61	6285-9283-62
	Basket	Black	6280-9283-81	6280-9283-82	6282-9283-81	6282-9283-82	6285-9283-81	6285-9283-82
	Hi Gloss	Black	6280-9283-91	6280-9283-92	6282-9283-91	6282-9283-92	6285-9283-91	6285-9283-92
	STX Tactical	Black	6280-9283-131	6280-9283-132	6282-9283-131	6282-9283-132	6285-9283-131	6285-9283-132
Glock 19, 19C, 23, 23C, 25, 32 w/ ITI M3 Light 4" BBL	Plain	Black	6280-2832-61	6280-2832-62	6282-2832-61	6282-2832-62	6285-2832-61	6285-2832-62
	Basket	Black	6280-2832-81	6280-2832-82	6282-2832-81	6282-2832-82	6285-2832-81	6285-2832-82
	Hi Gloss	Black	6280-2832-91	6280-2832-92	6282-2832-91	6282-2832-92	6285-2832-91	6285-2832-92
	STX Tactical	Black	6280-2832-131	6280-2832-132	6282-2832-131	6282-2832-132	6285-2832-131	6285-2832-132
Glock 20, 21 4.6" BBL	Plain	Black	6280-383-61	6280-383-62	6282-383-61	6282-383-62	6285-383-61	6285-383-62
	Basket	Black	6280-383-81	6280-383-82	6282-383-81	6282-383-82	6285-383-81	6285-383-82
	Hi Gloss	Black	6280-383-91	6280-383-92	6282-383-91	6282-383-92	6285-383-91	6285-383-92
	STX Tactical	Black	6280-383-131	6280-383-132	6282-383-131	6282-383-132	6285-383-131	6285-383-132
Glock 20, 21 w/ SureFire X200/X300 4.6" BBL	Plain	Black	6280-3830-61	6280-3830-62	6282-3830-61	6282-3830-62	6285-3830-61	6285-3830-62
	Basket	Black	6280-3830-81	6280-3830-82	6282-3830-81	6282-3830-82	6285-3830-81	6285-3830-82
	Hi Gloss	Black	6280-3830-91	6280-3830-92	6282-3830-91	6282-3830-92	6285-3830-91	6285-3830-92
	STX Tactical	Black	6280-3830-131	6280-3830-132	6282-3830-131	6282-3830-132	6285-3830-131	6285-3830-132
Glock 20, 21 w/ ITI M3 SureFire X200, X300 4.6" BBL	Plain	Black	6280-3832-61	6280-3832-62	6282-3832-61	6282-3832-62	6285-3832-61	6285-3832-62
	Basket	Black	6280-3832-81	6280-3832-82	6282-3832-81	6282-3832-82	6285-3832-81	6285-3832-82
	Hi Gloss	Black	6280-3832-91	6280-3832-92	6282-3832-91	6282-3832-92	6285-3832-91	6285-3832-92
	STX Tactical	Black	6280-3832-131	6280-3832-132	6282-3832-131	6282-3832-132	6285-3832-131	6285-3832-132
Glock 20, 21 w/ ITI M6 4.5" BBL	Plain	Black	6280-38321-61	6280-38321-62	6282-38321-61	6282-38321-62	6285-38321-61	6285-38321-62
	Basket	Black	6280-38321-81	6280-38321-82	6282-38321-81	6282-38321-82	6285-38321-81	6285-38321-82
	Hi Gloss	Black	6280-38321-91	6280-38321-92	6282-38321-91	6282-38321-92	6285-38321-91	6285-38321-92
	STX Tactical	Black	6280-38321-131	6280-38321-132	6282-38321-131	6282-38321-132	6285-38321-131	6285-38321-132

How to
Duty Holsters
Duty Accessories
Tactical Holsters
Tactical Accessories
Duty Belts
QAS
Speed Loaders
Light Systems
Concealment Holsters
Concealment Accessories
Competition
Apparel
Sales Support
Index/ Price List



Duty Holsters

6280/6282/6285 SLS LEVEL II RETENTION™ HOLSTERS FOR: PISTOLS (continued)

How to Order
Duty Holsters
Duty Accessories
Tactical Holsters
Tactical Accessories
Duty Belts
OAS
Speed Loaders
Light Systems
Concealment Holsters
Concealment Accessories
Competition
Apparel
Sales Support
Index/Price List

GUN DESCRIPTION	FINISH*	COLOR	6280 MID-RIDE		6282 HI-RIDE		6285 LOW-RIDE	
			RIGHT	LEFT	RIGHT	LEFT	RIGHT	LEFT
Glock 20, 21SF w/ Dual Magazine Release w/ ITI M3/M6, TLR-1/TLR-2, Insight XTI Procyon, SureFire X200/X300 4.6" BBL	Plain Basket Hi Gloss STX Tactical	Black Black Black Black	6280-938321-61 6280-938321-81 6280-938321-91 6280-938321-131	6280-938321-62 6280-938321-82 6280-938321-92 6280-938321-132	6282-938321-61 6282-938321-81 6282-938321-91 6282-938321-131	6282-938321-62 6282-938321-82 6282-938321-92 6282-938321-132	6285-938321-61 6285-938321-81 6285-938321-91 6285-938321-131	6285-938321-62 6285-938321-82 6285-938321-92 6285-938321-132
Glock 34, 35 5.32" BBL	Plain Basket Hi Gloss STX Tactical	Black Black Black Black	6280-683-61 6280-683-81 6280-683-91 6280-683-131	6280-683-62 6280-683-82 6280-683-92 6280-683-132	6282-683-61 6282-683-81 6282-683-91 6282-683-131	6282-683-62 6282-683-82 6282-683-92 6282-683-132	6285-683-61 6285-683-81 6285-683-91 6285-683-131	6285-683-62 6285-683-82 6285-683-92 6285-683-132
Glock 34, 35 w/ ITI M3 5.32" BBL	Plain Basket Hi Gloss STX Tactical	Black Black Black Black	6280-6832-61 6280-6832-81 6280-6832-91 6280-6832-131	6280-6832-62 6280-6832-82 6280-6832-92 6280-6832-132	6282-6832-61 6282-6832-81 6282-6832-91 6282-6832-131	6282-6832-62 6282-6832-82 6282-6832-92 6282-6832-132	6285-6832-61 6285-6832-81 6285-6832-91 6285-6832-131	6285-6832-62 6285-6832-82 6285-6832-92 6285-6832-132
Glock 34, 35 w/ ITI M3/M6 (N/A for M3X/M6X) 5.3" BBL	Plain Basket Hi Gloss STX Tactical	Black Black Black Black	6280-68321-61 6280-68321-81 6280-68321-91 6280-68321-131	6280-68321-62 6280-68321-82 6280-68321-92 6280-68321-132	6282-68321-61 6282-68321-81 6282-68321-91 6282-68321-131	6282-68321-62 6282-68321-82 6282-68321-92 6282-68321-132	6285-68321-61 6285-68321-81 6285-68321-91 6285-68321-131	6285-68321-62 6285-68321-82 6285-68321-92 6285-68321-132
Glock 37 4.5" BBL 38 4" BBL	Plain Basket Hi Gloss STX Tactical	Black Black Black Black	6280-783-61 6280-783-81 6280-783-91 6280-783-131	6280-783-62 6280-783-82 6280-783-92 6280-783-132	6282-783-61 6282-783-81 6282-783-91 6282-783-131	6282-783-62 6282-783-82 6282-783-92 6282-783-132	6285-783-61 6285-783-81 6285-783-91 6285-783-131	6285-783-62 6285-783-82 6285-783-92 6285-783-132
Glock 37 w/ ITI M3, TLR-1, Insight XTI Procyon, SureFire X200/X300/X300U 4.5" BBL	Plain Basket Hi Gloss STX Tactical	Black Black Black Black	6280-7832-61 6280-7832-81 6280-7832-91 6280-7832-131	6280-7832-62 6280-7832-82 6280-7832-92 6280-7832-132	6282-7832-61 6282-7832-81 6282-7832-91 6282-7832-131	6282-7832-62 6282-7832-82 6282-7832-92 6282-7832-132	6285-7832-61 6285-7832-81 6285-7832-91 6285-7832-131	6285-7832-62 6285-7832-82 6285-7832-92 6285-7832-132
Heckler & Koch P30 3.875" BBL	Plain Basket Hi Gloss STX Tactical	Black Black Black Black	6280-295-61 6280-295-81 6280-295-91 6280-295-131	6280-295-62 6280-295-82 6280-295-92 6280-295-132	6282-295-61 6282-295-81 6282-295-91 6282-295-131	6282-295-62 6282-295-82 6282-295-92 6282-295-132	6285-295-61 6285-295-81 6285-295-91 6285-295-131	6285-295-62 6285-295-82 6285-295-92 6285-295-132
Heckler & Koch P30L w/ ITI M3X/M6X 4.44" BBL	Plain Basket Hi Gloss STX Tactical	Black Black Black Black	6280-39512-61 6280-39512-81 6280-39512-91 6280-39512-131	6280-39512-62 6280-39512-82 6280-39512-92 6280-39512-132	6282-39512-61 6282-39512-81 6282-39512-91 6282-39512-131	6282-39512-62 6282-39512-82 6282-39512-92 6282-39512-132	6285-39512-61 6285-39512-81 6285-39512-91 6285-39512-131	6285-39512-62 6285-39512-82 6285-39512-92 6285-39512-132
Heckler & Koch P30L 9/40 w/ ITI M3, TLR-1, SureFire X200/X300/X300U 4.45" BBL	Plain Basket Hi Gloss STX Tactical	Black Black Black Black	6280-3952-61 6280-3952-81 6280-3952-91 6280-3952-131	6280-3952-62 6280-3952-82 6280-3952-92 6280-3952-132	6282-3952-61 6282-3952-81 6282-3952-91 6282-3952-131	6282-3952-62 6282-3952-82 6282-3952-92 6282-3952-132	6285-3952-61 6285-3952-81 6285-3952-91 6285-3952-131	6285-3952-62 6285-3952-82 6285-3952-92 6285-3952-132
Heckler & Koch P7, P7M8/M13 4.1" BBL	Plain Basket Hi Gloss STX Tactical	Black Black Black Black	6280-82-61 6280-82-81 6280-82-91 6280-82-131	6280-82-62 6280-82-82 6280-82-92 6280-82-132	6282-82-61 6282-82-81 6282-82-91 6282-82-131	6282-82-62 6282-82-82 6282-82-92 6282-82-132	6285-82-61 6285-82-81 6285-82-91 6285-82-131	6285-82-62 6285-82-82 6285-82-92 6285-82-132
Heckler & Koch USP 9mm DAO w/ SureFire Mount P105, P115 SureFire 4.13" BBL	Plain Basket Hi Gloss STX Tactical	Black Black Black Black	6280-1936-61 6280-1936-81 6280-1936-91 6280-1936-131	6280-1936-62 6280-1936-82 6280-1936-92 6280-1936-132	6282-1936-61 6282-1936-81 6282-1936-91 6282-1936-131	6282-1936-62 6282-1936-82 6282-1936-92 6282-1936-132	6285-1936-61 6285-1936-81 6285-1936-91 6285-1936-131	6285-1936-62 6285-1936-82 6285-1936-92 6285-1936-132
Heckler & Koch USP 9mm, .40 DAO w/ SureFire Mount w/ ITI M3X/M6X 4.13" BBL	Plain Basket Hi Gloss STX Tactical	Black Black Black Black	6280-19312-61 6280-19312-81 6280-19312-91 6280-19312-131	6280-19312-62 6280-19312-82 6280-19312-92 6280-19312-132	6282-19312-61 6282-19312-81 6282-19312-91 6282-19312-131	6282-19312-62 6282-19312-82 6282-19312-92 6282-19312-132	6285-19312-61 6285-19312-81 6285-19312-91 6285-19312-131	6285-19312-62 6285-19312-82 6285-19312-92 6285-19312-132
Heckler & Koch USP 9mm, .40 Hammer Down or cocked and locked w/ B&T Adapter w/ ITI M3/M6 and M3 LED 4.13" BBL	Plain Basket Hi Gloss STX Tactical	Black Black Black Black	6280-9221-61 6280-9221-81 6280-9221-91 6280-9221-131	6280-9221-62 6280-9221-82 6280-9221-92 6280-9221-132	6282-9221-61 6282-9221-81 6282-9221-91 6282-9221-131	6282-9221-62 6282-9221-82 6282-9221-92 6282-9221-132	6285-9221-61 6285-9221-81 6285-9221-91 6285-9221-131	6285-9221-62 6285-9221-82 6285-9221-92 6285-9221-132
Heckler & Koch USP 9mm, .40, .45 Hammer Down SureFire X200/X300 TLR-1/TLR-2, Insight XTI Procyon, USP 9mm, .40 4.13" BBL USP 45 4.41" BBL	Plain Basket Hi Gloss STX Tactical	Black Black Black Black	6280-9321-61 6280-9321-81 6280-9321-91 6280-9321-131	6280-9321-62 6280-9321-82 6280-9321-92 6280-9321-132	6282-9321-61 6282-9321-81 6282-9321-91 6282-9321-131	6282-9321-62 6282-9321-82 6282-9321-92 6282-9321-132	6285-9321-61 6285-9321-81 6285-9321-91 6285-9321-131	6285-9321-62 6285-9321-82 6285-9321-92 6285-9321-132



Duty Holsters

6280/6282/6285 SLS LEVEL II RETENTION™ HOLSTERS FOR: PISTOLS (continued)

How to Order
Duty Holsters
Duty Accessories
Tactical Holsters
Tactical Accessories
Duty Belts
QAS
Speed Loaders
Light Systems
Concealment Holsters
Concealment Accessories
Competition
Apparel
Sales Support
Index/Price List

GUN DESCRIPTION	FINISH*	COLOR	6280 MID-RIDE		6282 HI-RIDE		6285 LOW-RIDE	
			RIGHT	LEFT	RIGHT	LEFT	RIGHT	LEFT
Heckler & Koch USP 9mm, .40 Cocked and Locked w/ LAM Light 4.13" BBL	Plain	Black	6280-191-61	6280-191-62	6282-191-61	6282-191-62	6285-191-61	6285-191-62
	Basket	Black	6280-191-81	6280-191-82	6282-191-81	6282-191-82	6285-191-81	6285-191-82
	Hi Gloss	Black	6280-191-91	6280-191-92	6282-191-91	6282-191-92	6285-191-91	6285-191-92
	STX Tactical	Black	6280-191-131	6280-191-132	6282-191-131	6282-191-132	6285-191-131	6285-191-132
Heckler & Koch USP 40C w/ Bobbed Hammer 3.58" BBL	Plain	Black	6280-291-61	6280-291-62	6282-291-61	6282-291-62	6285-291-61	6285-291-62
	Basket	Black	6280-291-81	6280-291-82	6282-291-81	6282-291-82	6285-291-81	6285-291-82
	Hi Gloss	Black	6280-291-91	6280-291-92	6282-291-91	6282-291-92	6285-291-91	6285-291-92
	STX Tactical	Black	6280-291-131	6280-291-132	6282-291-131	6282-291-132	6285-291-131	6285-291-132
Heckler & Koch USP 40C, w/ Light Adapter w/ ITI M3/M6 or M3X (N/A for M6X) 3.58" BBL	Plain	Black	6280-29111-61	6280-29111-62	6282-29111-61	6282-29111-62	6285-29111-61	6285-29111-62
	Basket	Black	6280-29111-81	6280-29111-82	6282-29111-81	6282-29111-82	6285-29111-81	6285-29111-82
	Hi Gloss	Black	6280-29111-91	6280-29111-92	6282-29111-91	6282-29111-92	6285-29111-91	6285-29111-92
	STX Tactical	Black	6280-29111-131	6280-29111-132	6282-29111-131	6282-29111-132	6285-29111-131	6285-29111-132
Heckler & Koch USP .40 Expert 5.2" BBL	Plain	Black	6280-96-61	6280-96-62	6282-96-61	6282-96-62	6285-96-61	6285-96-62
	Basket	Black	6280-96-81	6280-96-82	6282-96-81	6282-96-82	6285-96-81	6285-96-82
	Hi Gloss	Black	6280-96-91	6280-96-92	6282-96-91	6282-96-92	6285-96-91	6285-96-92
	STX Tactical	Black	6280-96-131	6280-96-132	6282-96-131	6282-96-132	6285-96-131	6285-96-132
Heckler & Koch USP 45C 3.8" BBL	Plain	Black	6280-293-61	6280-293-62	6282-293-61	6282-293-62	6285-293-61	6285-293-62
	Basket	Black	6280-293-81	6280-293-82	6282-293-81	6282-293-82	6285-293-81	6285-293-82
	Hi Gloss	Black	6280-293-91	6280-293-92	6282-293-91	6282-293-92	6285-293-91	6285-293-92
	STX Tactical	Black	6280-293-131	6280-293-132	6282-293-131	6282-293-132	6285-293-131	6285-293-132
Heckler & Koch USP .45 Hammer Down 4.41" BBL USP 9mm, .40 Hammer Down 4.13" BBL	Plain	Black	6280-93-61	6280-93-62	6282-93-61	6282-93-62	6285-93-61	6285-93-62
	Basket	Black	6280-93-81	6280-93-82	6282-93-81	6282-93-82	6285-93-81	6285-93-82
	Hi Gloss	Black	6280-93-91	6280-93-92	6282-93-91	6282-93-92	6285-93-91	6285-93-92
	STX Tactical	Black	6280-93-131	6280-93-132	6282-93-131	6282-93-132	6285-93-131	6285-93-132
Heckler & Koch USP .45 LEM DAO w/ Bobbed Hammer, USP .45 w/ Spurred Hammer, w/ SureFire MR09 Light Adapter and SureFire X200/X300 4.41" BBL	Plain	Black	6280-930-61	6280-930-62	6282-930-61	6282-930-62	6285-930-61	6285-930-62
	Basket	Black	6280-930-81	6280-930-82	6282-930-81	6282-930-82	6285-930-81	6285-930-82
	Hi Gloss	Black	6280-930-91	6280-930-92	6282-930-91	6282-930-92	6285-930-91	6285-930-92
	STX Tactical	Black	6280-930-131	6280-930-132	6282-930-131	6282-930-132	6285-930-131	6285-930-132
Heckler & Koch HK .45 4.53" BBL	Plain	Black	6280-393-61	6280-393-62	6282-393-61	6282-393-62	6280-393-61	6285-393-62
	Basket	Black	6280-393-81	6280-393-82	6282-393-81	6282-393-82	6285-393-81	6285-393-82
	Hi Gloss	Black	6280-393-91	6280-393-92	6282-393-91	6282-393-92	6285-393-91	6285-393-92
	STX Tactical	Black	6280-393-131	6280-393-132	6282-393-131	6282-393-132	6285-393-131	6285-393-132
Heckler & Koch HK .45 Cocked & Locked w/ SureFire X200/X300/ X300U 4.53" BBL	Plain	Black	6280-3930-61	6280-3930-62	6282-3930-61	6282-3930-62	6280-3930-61	6285-3930-62
	Basket	Black	6280-3930-81	6280-3930-82	6282-3930-81	6282-3930-82	6285-3930-81	6285-3930-82
	Hi Gloss	Black	6280-3930-91	6280-3930-92	6282-3930-91	6282-3930-92	6285-3930-91	6285-3930-92
	STX Tactical	Black	6280-3930-131	6280-3930-132	6282-3930-131	6282-3930-132	6285-3930-131	6285-3930-132
Heckler & Koch P2000 3.5" BBL	Plain	Black	6280-97-61	6280-97-62	6282-97-61	6282-97-62	6280-97-61	6285-97-62
	Basket	Black	6280-97-81	6280-97-82	6282-97-81	6282-97-82	6285-97-81	6285-97-82
	Hi Gloss	Black	6280-97-91	6280-97-92	6282-97-91	6282-97-92	6285-97-91	6285-97-92
	STX Tactical	Black	6280-97-131	6280-97-132	6282-97-131	6282-97-132	6285-97-131	6285-97-132
Heckler & Koch P2000 DAO 3.5" BBL H&K P2000 SC 3.25" BBL	Plain	Black	6280-297-61	6280-297-62	6282-297-61	6282-297-62	6285-297-61	6285-297-62
	Basket	Black	6280-297-81	6280-297-82	6282-297-81	6282-297-82	6285-297-81	6285-297-82
	Hi Gloss	Black	6280-297-91	6280-297-92	6282-297-91	6282-297-92	6285-297-91	6285-297-92
	STX Tactical	Black	6280-297-131	6280-297-132	6282-297-131	6282-297-132	6285-297-131	6285-297-132
Heckler & Koch P2000 DAO Bobbed Hammer; w/ B&T Adapter w/ GTL 10 Light only, GTL 21/22 Light/Laser Combination, GTL 51/52 Light/Laser Combination 3.5" BBL	Plain	Black	6280-9710-61	6280-9710-62	6282-9710-61	6282-9710-62	6285-9710-61	6285-9710-62
	Basket	Black	6280-9710-81	6280-9710-82	6282-9710-81	6282-9710-82	6285-9710-81	6285-9710-82
	Hi Gloss	Black	6280-9710-91	6280-9710-92	6282-9710-91	6282-9710-92	6285-9710-91	6285-9710-92
	STX Tactical	Black	6280-9710-131	6280-9710-132	6282-9710-131	6282-9710-132	6285-9710-131	6285-9710-132
Heckler & Koch P2000 European Version w/ B&T Adapter (TL P2000) w/ M3/M6 ITI Lights Holster will not retain weapon w/o light attached 3.5" BBL	Plain	Black	6280-9721-61	6280-9721-62	6282-9721-61	6282-9721-62	6285-9721-61	6285-9721-62
	Basket	Black	6280-9721-81	6280-9721-82	6282-9721-81	6282-9721-82	6285-9721-81	6285-9721-82
	Hi Gloss	Black	6280-9721-91	6280-9721-92	6282-9721-91	6282-9721-92	6285-9721-91	6285-9721-92
	STX Tactical	Black	6280-9721-131	6280-9721-132	6282-9721-131	6282-9721-132	6285-9721-131	6285-9721-132
Heckler & Koch P2000 DAO US Version, w/ M3X Light, Bobbed Hammer 3.66" BBL	Plain	Black	6280-9711-61	6280-9711-62	6282-9711-61	6282-9711-62	6285-9711-61	6285-9711-62
	Basket	Black	6280-9711-81	6280-9711-82	6282-9711-81	6282-9711-82	6285-9711-81	6285-9711-82
	Hi Gloss	Black	6280-9711-91	6280-9711-92	6282-9711-91	6282-9711-92	6285-9711-91	6285-9711-92
	STX Tactical	Black	6280-9711-131	6280-9711-132	6282-9711-131	6282-9711-132	6285-9711-131	6285-9711-132



Duty Holsters

6280/6282/6285 SLS LEVEL II RETENTION™ HOLSTERS FOR: PISTOLS (continued)

How to Order
 Duty Holsters
 Duty Accessories
 Tactical Holsters
 Tactical Accessories
 Duty Belts
 OAS
 Speed Loaders
 Light Systems
 Concealment Holsters
 Concealment Accessories
 Competition
 Apparel
 Sales Support
 Index/Price List

GUN DESCRIPTION	FINISH*	COLOR	6280 MID-RIDE		6282 HI-RIDE		6285 LOW-RIDE	
			RIGHT	LEFT	RIGHT	LEFT	RIGHT	LEFT
Heckler & Koch P2000 US Version w/ ITI M3/M6 3.5" BBL	Plain	Black	6280-19721-61	6280-19721-62	6282-19721-61	6282-19721-62	6285-19721-61	6285-19721-62
	Basket	Black	6280-19721-81	6280-19721-82	6282-19721-81	6282-19721-82	6285-19721-81	6285-19721-82
	Hi Gloss	Black	6280-19721-91	6280-19721-92	6282-19721-91	6282-19721-92	6285-19721-91	6285-19721-92
	STX Tactical	Black	6280-19721-131	6280-19721-132	6282-19721-131	6282-19721-132	6285-19721-131	6285-19721-132
Kimber Custom 5" BBL	Plain	Black	6280-53-61	6280-53-62	6282-53-61	6282-53-62	6285-53-61	6285-53-62
	Basket	Black	6280-53-81	6280-53-82	6282-53-81	6282-53-82	6285-53-81	6285-53-82
	Hi Gloss	Black	6280-53-91	6280-53-92	6282-53-91	6282-53-92	6285-53-91	6285-53-92
	STX Tactical	Black	6280-53-131	6280-53-132	6282-53-131	6282-53-132	6285-53-131	6285-53-132
Kimber Gold Combat RL, Kimber Custom TLE, RL, w/ SureFire X200/X300/x300U 5" BBL	Plain	Black	6280-5340-61	6280-5340-62	6282-5340-61	6282-5340-62	6285-5340-61	6285-5340-62
	Basket	Black	6280-5340-81	6280-5340-82	6282-5340-81	6282-5340-82	6285-5340-81	6285-5340-82
	Hi Gloss	Black	6280-5340-91	6280-5340-92	6282-5340-91	6282-5340-92	6285-5340-91	6285-5340-92
	STX Tactical	Black	6280-5340-131	6280-5340-132	6282-5340-131	6282-5340-132	6285-5340-131	6285-5340-132
Ruger KP-94, KP-94DC 4.25" BBL KP-944, KP-944DC 4.2" BBL	Plain	Black	6280-69-61	6280-69-62	6282-69-61	6282-69-62	6285-69-61	6285-69-62
	Basket	Black	6280-69-81	6280-69-82	6282-69-81	6282-69-82	6285-69-81	6285-69-82
	Hi Gloss	Black	6280-69-91	6280-69-92	6282-69-91	6282-69-92	6285-69-91	6285-69-92
	STX Tactical	Black	6280-69-131	6280-69-132	6282-69-131	6282-69-132	6285-69-131	6285-69-132
Sig Sauer P220, P226, P220R, P226R w/ Full Size Hammer 4.41" BBL P226R MK25 4.41" BBL	Plain	Black	6280-77-61	6280-77-62	6282-77-61	6282-77-62	6285-77-61	6285-77-62
	Basket	Black	6280-77-81	6280-77-82	6282-77-81	6282-77-82	6285-77-81	6285-77-82
	Hi Gloss	Black	6280-77-91	6280-77-92	6282-77-91	6282-77-92	6285-77-91	6285-77-92
	STX Tactical	Black	6280-77-131	6280-77-132	6282-77-131	6282-77-132	6285-77-131	6285-77-132
Sig Sauer P220, P226, w/ ITI Mount w/ ITI M3X/M6X 4.41" BBL	Plain	Black	6280-7712-61	6280-7712-62	6282-7712-61	6282-7712-62	6285-7712-61	6285-7712-62
	Basket	Black	6280-7712-81	6280-7712-82	6282-7712-81	6282-7712-82	6285-7712-81	6285-7712-82
	Hi Gloss	Black	6280-7712-91	6280-7712-92	6282-7712-91	6282-7712-92	6285-7712-91	6285-7712-92
	STX Tactical	Black	6280-7712-131	6280-7712-132	6282-7712-131	6282-7712-132	6285-7712-131	6285-7712-132
Sig Sauer P220, P226 w/ ITI Light Mount, w/ ITI M3/M6 4.41" BBL	Plain	Black	6280-7721-61	6280-7721-62	6282-7721-61	6282-7721-62	6285-7721-61	6285-7721-62
	Basket	Black	6280-7721-81	6280-7721-82	6282-7721-81	6282-7721-82	6285-7721-81	6285-7721-82
	Hi Gloss	Black	6280-7721-91	6280-7721-92	6282-7721-91	6282-7721-92	6285-7721-91	6285-7721-92
	STX Tactical	Black	6280-7721-131	6280-7721-132	6282-7721-131	6282-7721-132	6285-7721-131	6285-7721-132
Sig Sauer P220, P226 w/ SureFire 3V 4.41" BBL	Plain	Black	6280-773-61	6280-773-62	6282-773-61	6282-773-62	6285-773-61	6285-773-62
	Basket	Black	6280-773-81	6280-773-82	6282-773-81	6282-773-82	6285-773-81	6285-773-82
	Hi Gloss	Black	6280-773-91	6280-773-92	6282-773-91	6282-773-92	6285-773-91	6285-773-92
	STX Tactical	Black	6280-773-131	6280-773-132	6282-773-131	6282-773-132	6285-773-131	6285-773-132
Sig Sauer P220R, P226R w/ ITI M3X/M6X 4.41" BBL	Plain	Black	6280-77412-61	6280-77412-62	6282-77412-61	6282-77412-62	6285-77412-61	6285-77412-62
	Basket	Black	6280-77412-81	6280-77412-82	6282-77412-81	6282-77412-82	6285-77412-81	6285-77412-82
	Hi Gloss	Black	6280-77412-91	6280-77412-92	6282-77412-91	6282-77412-92	6285-77412-91	6285-77412-92
	STX Tactical	Black	6280-77412-131	6280-77412-132	6282-77412-131	6282-77412-132	6285-77412-131	6285-77412-132
Sig Sauer P220R, P226R, w/ MOLAD Light Laser 4.41" BBL	Plain	Black	6280-77413-61	6280-77413-62	6282-77413-61	6282-77413-62	6285-77413-61	6285-77413-62
	Basket	Black	6280-77413-81	6280-77413-82	6282-77413-81	6282-77413-82	6285-77413-81	6285-77413-82
	Hi Gloss	Black	6280-77413-91	6280-77413-92	6282-77413-91	6282-77413-92	6285-77413-91	6285-77413-92
	STX Tactical	Black	6280-77413-131	6280-77413-132	6282-77413-131	6282-77413-132	6285-77413-131	6285-77413-132
Sig Sauer P220R, P220S, P226S, P226SO, P226R, w/ Accessory Rails and ITI M3/M6 4.41" BBL	Plain	Black	6280-77421-61	6280-77421-62	6282-77421-61	6282-77421-62	6285-77421-61	6285-77421-62
	Basket	Black	6280-77421-81	6280-77421-82	6282-77421-81	6282-77421-82	6285-77421-81	6285-77421-82
	Hi Gloss	Black	6280-77421-91	6280-77421-92	6282-77421-91	6282-77421-92	6285-77421-91	6285-77421-92
	STX Tactical	Black	6280-77421-131	6280-77421-132	6282-77421-131	6282-77421-132	6285-77421-131	6285-77421-132
Sig Sauer P220R, P220S, P226S, P226SO, P226R w/ Accessory Rails and SureFire Nitrolon Polymer Light model: P004 4.41" BBL	Plain	Black	6280-7746-61	6280-7746-62	6282-7746-61	6282-7746-62	6285-7746-61	6285-7746-62
	Basket	Black	6280-7746-81	6280-7746-82	6282-7746-81	6282-7746-82	6285-7746-81	6285-7746-82
	Hi Gloss	Black	6280-7746-91	6280-7746-92	6282-7746-91	6282-7746-92	6285-7746-91	6285-7746-92
	STX Tactical	Black	6280-7746-131	6280-7746-132	6282-7746-131	6282-7746-132	6285-7746-131	6285-7746-132
Sig Sauer P220, P226 w/ SureFire Military Light Models: W113C, W113D, W113, W114C, W114D, W114, P113, P113C, P113D, P114, P114C and P114D 4.41" BBL	Plain	Black	6280-778-61	6280-778-62	6282-778-61	6282-778-62	6285-778-61	6285-778-62
	Basket	Black	6280-778-81	6280-778-82	6282-778-81	6282-778-82	6285-778-81	6285-778-82
	Hi Gloss	Black	6280-778-91	6280-778-92	6282-778-91	6282-778-92	6285-778-91	6285-778-92
	STX Tactical	Black	6280-778-131	6280-778-132	6282-778-131	6282-778-132	6285-778-131	6285-778-132
Sig Sauer P220SO, P220ST, P220R, P226R w/ SureFire X200/X300 4.41" BBL	Plain	Black	6280-7740-61	6280-7740-62	6282-7740-61	6282-7740-62	6285-7740-61	6285-7740-62
	Basket	Black	6280-7740-81	6280-7740-82	6282-7740-81	6282-7740-82	6285-7740-81	6285-7740-82
	Hi Gloss	Black	6280-7740-91	6280-7740-92	6282-7740-91	6282-7740-92	6285-7740-91	6285-7740-92
	STX Tactical	Black	6280-7740-131	6280-7740-132	6282-7740-131	6282-7740-132	6285-7740-131	6285-7740-132
Sig Sauer P220R DAK, P226R DAK w/ Bobbed Hammer 4.41" BBL	Plain	Black	6280-277-61	6280-277-62	6282-277-61	6282-277-62	6285-277-61	6285-277-62
	Basket	Black	6280-277-81	6280-277-82	6282-277-81	6282-277-82	6285-277-81	6285-277-82
	Hi Gloss	Black	6280-277-91	6280-277-92	6282-277-91	6282-277-92	6285-277-91	6285-277-92
	STX Tactical	Black	6280-277-131	6280-277-132	6282-277-131	6282-277-132	6285-277-131	6285-277-132



Duty Holsters

6280/6282/6285 SLS LEVEL II RETENTION™ HOLSTERS FOR: PISTOLS (continued)

How to Order
Duty Holsters
Duty Accessories
Tactical Holsters
Tactical Accessories
Duty Belts
DAS
Speed Loaders
Light Systems
Concealment Holsters
Concealment Accessories
Competition
Apparel
Sales Support
Index/Price List

GUN DESCRIPTION	FINISH*	COLOR	6280 MID-RIDE		6282 HI-RIDE		6285 LOW-RIDE	
			RIGHT	LEFT	RIGHT	LEFT	RIGHT	LEFT
Sig Sauer P220R DAK, P226R DAK Bobbed Hammer w/ SureFire X200/X300 4.41" BBL	Plain	Black	6280-2770-61	6280-2770-62	6282-2770-61	6282-2770-62	6285-2770-61	6285-2770-62
	Basket	Black	6280-2770-81	6280-2770-82	6282-2770-81	6282-2770-82	6285-2770-81	6285-2770-82
	Hi Gloss	Black	6280-2770-91	6280-2770-92	6282-2770-91	6282-2770-92	6285-2770-91	6285-2770-92
	STX Tactical	Black	6280-2770-131	6280-2770-132	6282-2770-131	6282-2770-132	6285-2770-131	6285-2770-132
Sig Sauer P220R DAK, P226R DAK w/ ITI M3/M6 w/ Bobbed Hammer 4.41" BBL	Plain	Black	6280-27721-61	6280-27721-62	6282-27721-61	6282-27721-62	6285-27721-61	6285-27721-62
	Basket	Black	6280-27721-81	6280-27721-82	6282-27721-81	6282-27721-82	6285-27721-81	6285-27721-82
	Hi Gloss	Black	6280-27721-91	6280-27721-92	6282-27721-91	6282-27721-92	6285-27721-91	6285-27721-92
	STX Tactical	Black	6280-27721-131	6280-27721-132	6282-27721-131	6282-27721-132	6285-27721-131	6285-27721-132
Sig Sauer P220R, P226R w/ SureFire X400/X400U 4.41" BBL	Plain	Black	6280-77414-61	6280-77414-62	6282-77414-61	6282-77414-62	6285-77414-61	6285-77414-62
	Basket	Black	6280-77414-81	6280-77414-82	6282-77414-81	6282-77414-82	6285-77414-81	6285-77414-82
	Hi Gloss	Black	6280-77414-91	6280-77414-92	6282-77414-91	6282-77414-92	6285-77414-91	6285-77414-92
	STX Tactical	Black	6280-77414-131	6280-77414-132	6282-77414-131	6282-77414-132	6285-77414-131	6285-77414-132
Sig Sauer P225, P226, P229 P229R, P229 DA/SA 3.9" BBL P220R Compact 3.75" BBL	Plain	Black	6280-74-61	6280-74-62	6282-74-61	6282-74-62	6285-74-61	6285-74-62
	Basket	Black	6280-74-81	6280-74-82	6282-74-81	6282-74-82	6285-74-81	6285-74-82
	Hi Gloss	Black	6280-74-91	6280-74-92	6282-74-91	6282-74-92	6285-74-91	6285-74-92
	STX Tactical	Black	6280-74-131	6280-74-132	6282-74-131	6282-74-132	6285-74-131	6285-74-132
Sig Sauer P226, w/ SureFire MR14 Rail & SureFire X200/X300 4.41" BBL	Plain	Black	6280-7700-61	6280-7700-62	6282-7700-61	6282-7700-62	6285-7700-61	6285-7700-62
	Basket	Black	6280-7700-81	6280-7700-82	6282-7700-81	6282-7700-82	6285-7700-81	6285-7700-82
	Hi Gloss	Black	6280-7700-91	6280-7700-92	6282-7700-91	6282-7700-92	6285-7700-91	6285-7700-92
	STX Tactical	Black	6280-7700-131	6280-7700-132	6282-7700-131	6282-7700-132	6285-7700-131	6285-7700-132
Sig Sauer P226R X-Five w/ SureFire X200/X300/X300U 5" BBL	Plain	Black	6280-3770-61	6280-3770-62	6282-3770-61	6282-3770-62	6285-3770-61	6285-3770-62
	Basket	Black	6280-3770-81	6280-3770-82	6282-3770-81	6282-3770-82	6285-3770-81	6285-3770-82
	Hi Gloss	Black	6280-3770-91	6280-3770-92	6282-3770-91	6282-3770-92	6285-3770-91	6285-3770-92
	STX Tactical	Black	6280-3770-131	6280-3770-132	6282-3770-131	6282-3770-132	6285-3770-131	6285-3770-132
Sig Sauer P227 4.4" BBL	Plain	Black	6280-77-61	6280-77-62	6282-77-61	6282-77-62	6285-77-61	6285-77-62
	Basket	Black	6280-77-81	6280-77-82	6282-77-81	6282-77-82	6285-77-81	6285-77-82
	Hi Gloss	Black	6280-77-91	6280-77-92	6282-77-91	6282-77-92	6285-77-91	6285-77-92
	STX Tactical	Black	6280-77-131	6280-77-132	6282-77-131	6282-77-132	6285-77-131	6285-77-132
Sig Sauer P229R DAK DAO w/ Bobbed Hammer 3.9" BBL	Plain	Black	6280-174-61	6280-174-62	6282-174-61	6282-174-62	6285-174-61	6285-174-62
	Basket	Black	6280-174-81	6280-174-82	6282-174-81	6282-174-82	6285-174-81	6285-174-82
	Hi Gloss	Black	6280-174-91	6280-174-92	6282-174-91	6282-174-92	6285-174-91	6285-174-92
	STX Tactical	Black	6280-174-131	6280-174-132	6282-174-131	6282-174-132	6285-174-131	6285-174-132
Sig Sauer P229R DAK w/ Bobbed Hammer w/ ITI M3X/M6X 3.9 BBL*	Plain	Black	6280-17412-61	6280-17412-62	6282-17412-61	6282-17412-62	6285-17412-61	6285-17412-62
	Basket	Black	6280-17412-81	6280-17412-82	6282-17412-81	6282-17412-82	6285-17412-81	6285-17412-82
	Hi Gloss	Black	6280-17412-91	6280-17412-92	6282-17412-91	6282-17412-92	6285-17412-91	6285-17412-92
	STX Tactical	Black	6280-17412-131	6280-17412-132	6282-17412-131	6282-17412-132	6285-17412-131	6285-17412-132
Sig Sauer P229R DAK w/ Bobbed Hammer w/ SureFire X200/X300 3.9" BBL	Plain	Black	6280-1740-61	6280-1740-62	6282-1740-61	6282-1740-62	6285-1740-61	6285-1740-62
	Basket	Black	6280-1740-81	6280-1740-82	6282-1740-81	6282-1740-82	6285-1740-81	6285-1740-82
	Hi Gloss	Black	6280-1740-91	6280-1740-92	6282-1740-91	6282-1740-92	6285-1740-91	6285-1740-92
	STX Tactical	Black	6280-1740-131	6280-1740-132	6282-1740-131	6282-1740-132	6285-1740-131	6285-1740-132
Sig Sauer P229R DAK w/ Light Rails Bobbed Hammer w/ ITI M3/M6 and M3 LED 3.9" BBL	Plain	Black	6280-17421-61	6280-17421-62	6282-17421-61	6282-17421-62	6285-17421-61	6285-17421-62
	Basket	Black	6280-17421-81	6280-17421-82	6282-17421-81	6282-17421-82	6285-17421-81	6285-17421-82
	Hi Gloss	Black	6280-17421-91	6280-17421-92	6282-17421-91	6282-17421-92	6285-17421-91	6285-17421-92
	STX Tactical	Black	6280-17421-131	6280-17421-132	6282-17421-131	6282-17421-132	6285-17421-131	6285-17421-132
Sig Sauer P229R, DA/SA w/ ITI M3/M6 (N/A for M3X/M6X) 3.9" BBL	Plain	Black	6280-74421-61	6280-74421-62	6282-74421-61	6282-74421-62	6285-74421-61	6285-74421-62
	Basket	Black	6280-74421-81	6280-74421-82	6282-74421-81	6282-74421-82	6285-74421-81	6285-74421-82
	Hi Gloss	Black	6280-74421-91	6280-74421-92	6282-74421-91	6282-74421-92	6285-74421-91	6285-74421-92
	STX Tactical	Black	6280-74421-131	6280-74421-132	6282-74421-131	6282-74421-132	6285-74421-131	6285-74421-132
Sig Sauer GSR Revolution 1911 w/ & w/o Light Rails 5" BBL	Plain	Black	6280-256-61	6280-256-62	6282-256-61	6282-256-62	6285-256-61	6285-256-62
	Basket	Black	6280-256-81	6280-256-82	6282-256-81	6282-256-82	6285-256-81	6285-256-82
	Hi Gloss	Black	6280-256-91	6280-256-92	6282-256-91	6282-256-92	6285-256-91	6285-256-92
	STX Tactical	Black	6280-256-131	6280-256-132	6282-256-131	6282-256-132	6285-256-131	6285-256-132
Sig Sauer GSR Revolution 1911 w/ ITI M3/M6, TLR-1/TLR-2 & SureFire X200/X300 & SSL-1 5" BBL	Plain	Black	6280-25621-61	6280-25621-62	6282-25621-61	6282-25621-62	6285-25621-61	6285-25621-62
	Basket	Black	6280-25621-81	6280-25621-82	6282-25621-81	6282-25621-82	6285-25621-81	6285-25621-82
	Hi Gloss	Black	6280-25621-91	6280-25621-92	6282-25621-91	6282-25621-92	6285-25621-91	6285-25621-92
	STX Tactical	Black	6280-25621-131	6280-25621-132	6282-25621-131	6282-25621-132	6285-25621-131	6285-25621-132
Sig Sauer P239 3.625" BBL	Plain	Black	6280-75-61	6280-75-62	6282-75-61	6282-75-62	6285-75-61	6285-75-62
	Basket	Black	6280-75-81	6280-75-82	6282-75-81	6282-75-82	6285-75-81	6285-75-82
	Hi Gloss	Black	6280-75-91	6280-75-92	6282-75-91	6282-75-92	6285-75-91	6285-75-92
	STX Tactical	Black	6280-75-131	6280-75-132	6282-75-131	6282-75-132	6285-75-131	6285-75-132



Duty Holsters

6280/6282/6285 SLS LEVEL II RETENTION™ HOLSTERS FOR: PISTOLS (continued)

How to Order
 Duty Holsters
 Duty Accessories
 Tactical Holsters
 Tactical Accessories
 Duty Belts
 OAS
 Speed Loaders
 Light Systems
 Concealment Holsters
 Concealment Accessories
 Competition
 Apparel
 Sales Support
 Index/Price List

GUN DESCRIPTION	FINISH*	COLOR	6280 MID-RIDE		6282 HI-RIDE		6285 LOW-RIDE	
			RIGHT	LEFT	RIGHT	LEFT	RIGHT	LEFT
Sig Sauer P250 9mm, .40 4.7" BBL	Plain	Black	6280-450-61	6280-450-62	6282-450-61	6282-450-62	6285-450-61	6285-450-62
	Basket	Black	6280-450-81	6280-450-82	6282-450-81	6282-450-82	6285-450-81	6285-450-82
	Hi Gloss	Black	6280-450-91	6280-450-92	6282-450-91	6282-450-92	6285-450-91	6285-450-92
	STX Tactical	Black	6280-450-131	6280-450-132	6282-450-131	6282-450-132	6285-450-131	6285-450-132
Sig Sauer P250 Compact 9mm, .40, .45 3.9" BBL	Plain	Black	6280-750-61	6280-750-62	6282-750-61	6282-750-62	6285-750-61	6285-750-62
	Basket	Black	6280-750-81	6280-750-82	6282-750-81	6282-750-82	6285-750-81	6285-750-82
	Hi Gloss	Black	6280-750-91	6280-750-92	6282-750-91	6282-750-92	6285-750-91	6285-750-92
	STX Tactical	Black	6280-750-131	6280-750-132	6282-750-131	6282-750-132	6285-750-131	6285-750-132
Sig Sauer Sig Pro SPC-2009 w/ Light Mount Rail 3.5" BBL	Plain	Black	6280-278-61	6280-278-62	6282-278-61	6282-278-62	6285-278-61	6285-278-62
	Basket	Black	6280-278-81	6280-278-82	6282-278-81	6282-278-82	6285-278-81	6285-278-82
	Hi Gloss	Black	6280-278-91	6280-278-92	6282-278-91	6282-278-92	6285-278-91	6285-278-92
	STX Tactical	Black	6280-278-131	6280-278-132	6282-278-131	6282-278-132	6285-278-131	6285-278-132
Sig Sauer Sig Pro P2022 w/ ITI M3/M6 3.5" BBL	Plain	Black	6280-27821-61	6280-27821-62	6282-27821-61	6282-27821-62	6285-27821-61	6285-27821-62
	Basket	Black	6280-27821-81	6280-27821-82	6282-27821-81	6282-27821-82	6285-27821-81	6285-27821-82
	Hi Gloss	Black	6280-27821-91	6280-27821-92	6282-27821-91	6282-27821-92	6285-27821-91	6285-27821-92
	STX Tactical	Black	6280-27821-131	6280-27821-132	6282-27821-131	6282-27821-132	6285-27821-131	6285-27821-132
Sig Sauer Sig Pro SP2340 3.875" BBL	Plain	Black	6280-78-61	6280-78-62	6282-78-61	6282-78-62	6285-78-61	6285-78-62
	Basket	Black	6280-78-81	6280-78-82	6282-78-81	6282-78-82	6285-78-81	6285-78-82
	Hi Gloss	Black	6280-78-91	6280-78-92	6282-78-91	6282-78-92	6285-78-91	6285-78-92
	STX Tactical	Black	6280-78-131	6280-78-132	6282-78-131	6282-78-132	6285-78-131	6285-78-132
Smith & Wesson 4006, 4043, 4046, 5903, 5904, 5906, 5946 4" BBL 4006TSW, 4046TSW, 5906TSW, 5946TSW, w/ Light Rails 4" BBL 6946 3.5" BBL	Plain	Black	6280-140-61	6280-140-62	6282-140-61	6282-140-62	6285-140-61	6285-140-62
	Basket	Black	6280-140-81	6280-140-82	6282-140-81	6282-140-82	6285-140-81	6285-140-82
	Hi Gloss	Black	6280-140-91	6280-140-92	6282-140-91	6282-140-92	6285-140-91	6285-140-92
	STX Tactical	Black	6280-140-131	6280-140-132	6282-140-131	6282-140-132	6285-140-131	6285-140-132
Smith & Wesson* 4006TSW, w/ Bolt on S & W Light Rail, 4006TSW w/ Bobbed Hammer & Picatinny Light Rail 4" BBL	Plain	Black	6280-141-61	6280-141-62	6282-141-61	6282-141-62	6285-141-61	6285-141-62
	Basket	Black	6280-141-81	6280-141-82	6282-141-81	6282-141-82	6285-141-81	6285-141-82
	Hi Gloss	Black	6280-141-91	6280-141-92	6282-141-91	6282-141-92	6285-141-91	6285-141-92
	STX Tactical	Black	6280-141-131	6280-141-132	6282-141-131	6282-141-132	6285-141-131	6285-141-132
Smith & Wesson Sigma 9C, Sigma 40C 4" BBL	Plain	Black	6280-39-61	6280-39-62	6282-39-61	6282-39-62	6285-39-61	6285-39-62
	Basket	Black	6280-39-81	6280-39-82	6282-39-81	6282-39-82	6285-39-81	6285-39-82
	Hi Gloss	Black	6280-39-91	6280-39-92	6282-39-91	6282-39-92	6285-39-91	6285-39-92
	STX Tactical	Black	6280-39-131	6280-39-132	6282-39-131	6282-39-132	6285-39-131	6285-39-132
Smith & Wesson Sigma 9F, Sigma 40F 4.5" BBL	Plain	Black	6280-40-61	6280-40-62	6282-40-61	6282-40-62	6285-40-61	6285-40-62
	Basket	Black	6280-40-81	6280-40-82	6282-40-81	6282-40-82	6285-40-81	6285-40-82
	Hi Gloss	Black	6280-40-91	6280-40-92	6282-40-91	6282-40-92	6285-40-91	6285-40-92
	STX Tactical	Black	6280-40-131	6280-40-132	6282-40-131	6282-40-132	6285-40-131	6285-40-132
Smith & Wesson 645, 1006, 4506, 4506-1 5" BBL 4566 4.25" BBL 4566TSW, 4563TSW 4.25" BBL	Plain	Black	6280-210-61	6280-210-62	6282-210-61	6282-210-62	6285-210-61	6285-210-62
	Basket	Black	6280-210-81	6280-210-82	6282-210-81	6282-210-82	6285-210-81	6285-210-82
	Hi Gloss	Black	6280-210-91	6280-210-92	6282-210-91	6282-210-92	6285-210-91	6285-210-92
	STX Tactical	Black	6280-210-131	6280-210-132	6282-210-131	6282-210-132	6285-210-131	6285-210-132
Smith & Wesson 6904, 6906, 6924 6926, 4013TSW Short Round Trigger Guard 3.5" BBL	Plain	Black	6280-20-61	6280-20-62	6282-20-61	6282-20-62	6285-20-61	6285-20-62
	Basket	Black	6280-20-81	6280-20-82	6282-20-81	6282-20-82	6285-20-81	6285-20-82
	Hi Gloss	Black	6280-20-91	6280-20-92	6282-20-91	6282-20-92	6285-20-91	6285-20-92
	STX Tactical	Black	6280-20-131	6280-20-132	6282-20-131	6282-20-132	6285-20-131	6285-20-132
Smith & Wesson 4053 3.5" BBL	Plain	Black	6280-340-61	6280-340-62	6282-340-61	6282-340-62	6285-340-61	6285-340-62
	Basket	Black	6280-340-81	6280-340-82	6282-340-81	6282-340-82	6285-340-81	6285-340-82
	Hi Gloss	Black	6280-340-91	6280-340-92	6282-340-91	6282-340-92	6285-340-91	6285-340-92
	STX Tactical	Black	6280-340-131	6280-340-132	6282-340-131	6282-340-132	6285-340-131	6285-340-132
Smith & Wesson M&P 9C, 40C w/ Thumb Safety 3.375" BBL	Plain	Black	6280-719-61	6280-719-62	6282-719-61	6282-719-62	6285-719-61	6285-719-62
	Basket	Black	6280-719-81	6280-719-82	6282-719-81	6282-719-82	6285-719-81	6285-719-82
	Hi Gloss	Black	6280-719-91	6280-719-92	6282-719-91	6282-719-92	6285-719-91	6285-719-92
	STX Tactical	Black	6280-719-131	6280-719-132	6282-719-131	6282-719-132	6285-719-131	6285-719-132
Smith & Wesson M&P 9L 5" BBL	Plain	Black	6280-819-61	6280-819-62	6282-819-61	6282-819-62	6285-819-61	6285-819-62
	Basket	Black	6280-819-81	6280-819-82	6282-819-81	6282-819-82	6285-819-81	6285-819-82
	Hi Gloss	Black	6280-819-91	6280-819-92	6282-819-91	6282-819-92	6285-819-91	6285-819-92
	STX Tactical	Black	6280-819-131	6280-819-132	6282-819-131	6282-819-132	6285-819-131	6285-819-132

*All with full size serrated hammer on the standard models, semi-bobbed hammer on DAO handguns with short round trigger guard for 6280-140



Duty Holsters

6280/6282/6285 SLS LEVEL II RETENTION™ HOLSTERS FOR: PISTOLS (continued)

GUN DESCRIPTION	FINISH*	COLOR	6280 MID-RIDE		6282 HI-RIDE		6285 LOW-RIDE	
			RIGHT	LEFT	RIGHT	LEFT	RIGHT	LEFT
Smith & Wesson M&P 9mm, .40 4.25" BBL	Plain	Black	6280-219-61	6280-219-62	6282-219-61	6282-219-62	6285-219-61	6285-219-62
	Basket	Black	6280-219-81	6280-219-82	6282-219-81	6282-219-82	6285-219-81	6285-219-82
	Hi Gloss	Black	6280-219-91	6280-219-92	6282-219-91	6282-219-92	6285-219-91	6285-219-92
	STX Tactical	Black	6280-219-131	6280-219-132	6282-219-131	6282-219-132	6285-219-131	6285-219-132
Smith & Wesson M&P 9mm, .40 w/ Surefire X200/X300/X300U 4.25" BBL	Plain	Black	6280-619-61	6280-619-62	6282-619-61	6282-619-62	6285-619-61	6285-619-62
	Basket	Black	6280-619-81	6280-619-82	6282-619-81	6282-619-82	6285-619-81	6285-619-82
	Hi Gloss	Black	6280-619-91	6280-619-92	6282-619-91	6282-619-92	6285-619-91	6285-619-92
	STX Tactical	Black	6280-619-131	6280-619-132	6282-619-131	6282-619-132	6285-619-131	6285-619-132
Smith & Wesson M&P 9mm, .40 w/ Surefire X200/X300/X300U 4.25" BBL	Plain	Black	6280-2190-61	6280-2190-62	6282-2190-61	6282-2190-62	6285-2190-61	6285-2190-62
	Basket	Black	6280-2190-81	6280-2190-82	6282-2190-81	6282-2190-82	6285-2190-81	6285-2190-82
	Hi Gloss	Black	6280-2190-91	6280-2190-92	6282-2190-91	6282-2190-92	6285-2190-91	6285-2190-92
	STX Tactical	Black	6280-2190-131	6280-2190-132	6282-2190-131	6282-2190-132	6285-2190-131	6285-2190-132
Smith & Wesson M&P 9mm, .40, w/ ITI M3/M6 Streamlight TLR-1/TLR-2 4.25" BBL	Plain	Black	6280-21921-61	6280-21921-62	6282-21921-61	6282-21921-62	6285-21921-61	6285-21921-62
	Basket	Black	6280-21921-81	6280-21921-82	6282-21921-81	6282-21921-82	6285-21921-81	6285-21921-82
	Hi Gloss	Black	6280-21921-91	6280-21921-92	6282-21921-91	6282-21921-92	6285-21921-91	6285-21921-92
	STX Tactical	Black	6280-21921-131	6280-21921-132	6282-21921-131	6282-21921-132	6285-21921-131	6285-21921-132
Smith & Wesson M&P .45 w/ & w/o Safety 4.5" BBL	Plain	Black	6280-519-61	6280-519-62	6282-519-61	6282-519-62	6285-519-61	6285-519-62
	Basket	Black	6280-519-81	6280-519-82	6282-519-81	6282-519-82	6285-519-81	6285-519-82
	Hi Gloss	Black	6280-519-91	6280-519-92	6282-519-91	6282-519-92	6285-519-91	6285-519-92
	STX Tactical	Black	6280-519-131	6280-519-132	6282-519-131	6282-519-132	6285-519-131	6285-519-132
Smith & Wesson M&P .45 w/ & w/o Safety w/ ITI M3/M6, Streamlight TLR-1/TLR-2, SureFire X200/X300, LAS-TAC 2 4.5" BBL	Plain	Black	6280-51921-61	6280-51921-62	6282-51921-61	6282-51921-62	6285-51921-61	6285-51921-62
	Basket	Black	6280-51921-81	6280-51921-82	6282-51921-81	6282-51921-82	6285-51921-81	6285-51921-82
	Hi Gloss	Black	6280-51921-91	6280-51921-92	6282-51921-91	6282-51921-92	6285-51921-91	6285-51921-92
	STX Tactical	Black	6280-51921-131	6280-51921-132	6282-51921-131	6282-51921-132	6285-51921-131	6285-51921-132
Smith & Wesson SW99 4" BBL	Plain	Black	6280-84-61	6280-84-62	6282-84-61	6282-84-62	6285-84-61	6285-84-62
	Basket	Black	6280-84-81	6280-84-82	6282-84-81	6282-84-82	6285-84-81	6285-84-82
	Hi Gloss	Black	6280-84-91	6280-84-92	6282-84-91	6282-84-92	6285-84-91	6285-84-92
	STX Tactical	Black	6280-84-131	6280-84-132	6282-84-131	6282-84-132	6285-84-131	6285-84-132
Smith & Wesson SW99 w/ ITI M5 4" BBL	Plain	Black	6280-842-61	6280-842-62	6282-842-61	6282-842-62	6285-842-61	6285-842-62
	Basket	Black	6280-842-81	6280-842-82	6282-842-81	6282-842-82	6285-842-81	6285-842-82
	Hi Gloss	Black	6280-842-91	6280-842-92	6282-842-91	6282-842-92	6285-842-91	6285-842-92
	STX Tactical	Black	6280-842-131	6280-842-132	6282-842-131	6282-842-132	6285-842-131	6285-842-132
Smith & Wesson SW99 .45ACP 4.25" BBL	Plain	Black	6280-86-61	6280-86-62	6282-86-61	6282-86-62	6285-86-61	6285-86-62
	Basket	Black	6280-86-81	6280-86-82	6282-86-81	6282-86-82	6285-86-81	6285-86-82
	Hi Gloss	Black	6280-86-91	6280-86-92	6282-86-91	6282-86-92	6285-86-91	6285-86-92
	STX Tactical	Black	6280-86-131	6280-86-132	6282-86-131	6282-86-132	6285-86-131	6285-86-132
Smith & Wesson 4566TSW w/ Light Rails & ITI M5 4.125" BBL	Plain	Black	6280-4302-61	6280-4302-62	6282-4302-61	6282-4302-62	6285-4302-61	6285-4302-62
	Basket	Black	6280-4302-81	6280-4302-82	6282-4302-81	6282-4302-82	6285-4302-81	6285-4302-82
	Hi Gloss	Black	6280-4302-91	6280-4302-92	6282-4302-91	6282-4302-92	6285-4302-91	6285-4302-92
	STX Tactical	Black	6280-4302-131	6280-4302-132	6282-4302-131	6282-4302-132	6285-4302-131	6285-4302-132
Smith & Wesson 5906 TSW, 5946TSW, 4006 TSW, 4046TSW, w/ M5 ITI/Streamlight 4" BBL	Plain	Black	6280-1402-61	6280-1402-62	6282-1402-61	6282-1402-62	6285-1402-61	6285-1402-62
	Basket	Black	6280-1402-81	6280-1402-82	6282-1402-81	6282-1402-82	6285-1402-81	6285-1402-82
	Hi Gloss	Black	6280-1402-91	6280-1402-92	6282-1402-91	6282-1402-92	6285-1402-91	6285-1402-92
	STX Tactical	Black	6280-1402-131	6280-1402-132	6282-1402-131	6282-1402-132	6285-1402-131	6285-1402-132
Sphinx 3000 Cocked & Locked or Hammer Down 3.75" BBL, 4.5" BBL	Plain	Black	6280-182-61	6280-182-62	6282-182-61	6282-182-62	6285-182-61	6285-182-62
	Basket	Black	6280-182-81	6280-182-82	6282-182-81	6282-182-82	6285-182-81	6285-182-82
	Hi Gloss	Black	6280-182-91	6280-182-92	6282-182-91	6282-182-92	6285-182-91	6285-182-92
	STX Tactical	Black	6280-182-131	6280-182-132	6282-182-131	6282-182-132	6285-182-131	6285-182-132
Sphinx 3000 Cocked & Locked w/ ITI Lam Light 3.75" BBL, 4.5" BBL	Plain	Black	6280-1825-61	6280-1825-62	6282-1825-61	6282-1825-62	6285-1825-61	6285-1825-62
	Basket	Black	6280-1825-81	6280-1825-82	6282-1825-81	6282-1825-82	6285-1825-81	6285-1825-82
	Hi Gloss	Black	6280-1825-91	6280-1825-92	6282-1825-91	6282-1825-92	6285-1825-91	6285-1825-92
	STX Tactical	Black	6280-1825-131	6280-1825-132	6282-1825-131	6282-1825-132	6285-1825-131	6285-1825-132
Sphinx SDP w/ SureFire X400U 4.5" BBL	Plain	Black	6280-28114-61	6280-28114-62	6282-28114-61	6282-28114-62	6285-28114-61	6285-28114-62
	Basket	Black	6280-28114-81	6280-28114-82	6282-28114-81	6282-28114-82	6285-28114-81	6285-28114-82
	Hi Gloss	Black	6280-28114-91	6280-28114-92	6282-28114-91	6282-28114-92	6285-28114-91	6285-28114-92
	STX Tactical	Black	6280-28114-131	6280-28114-132	6282-28114-131	6282-28114-132	6285-28114-131	6285-28114-132
Springfield Armory XD 9mm, .40, .357, .45 4" BBL	Plain	Black	6280-148-61	6280-148-62	6282-148-61	6282-148-62	6285-148-61	6285-148-62
	Basket	Black	6280-148-81	6280-148-82	6282-148-81	6282-148-82	6285-148-81	6285-148-82
	Hi Gloss	Black	6280-148-91	6280-148-92	6282-148-91	6282-148-92	6285-148-91	6285-148-92
	STX Tactical	Black	6280-148-131	6280-148-132	6282-148-131	6282-148-132	6285-148-131	6285-148-132

How to
Order
Duty
Holsters
Duty
Accessories
Tactical
Holsters
Tactical
Accessories
Duty
Belts
DAS
Speed
Loaders
Light
Systems
Concealment
Holsters
Concealment
Accessories
Competition
Apparel
Sales
Support
Index/
Price
List



Duty Holsters

6280/6282/6285 SLS LEVEL II RETENTION™ HOLSTERS FOR: PISTOLS (continued)

How to Order
 Duty Holsters
 Duty Accessories
 Tactical Holsters
 Tactical Accessories
 Duty Belts
 OAS
 Speed Loaders
 Light Systems
 Concealment Holsters
 Concealment Accessories
 Competition
 Apparel
 Sales Support
 Index/Price List

GUN DESCRIPTION	FINISH*	COLOR	6280 MID-RIDE		6282 HI-RIDE		6285 LOW-RIDE	
			RIGHT	LEFT	RIGHT	LEFT	RIGHT	LEFT
Springfield Armory XD, 9mm, .40, .45 w/ ITI M3/M6, Streamlight TLR-1/TLR-2, SureFire X200/X300 or LAS-TAC 2 4" BBL	Plain	Black	6280-14821-61	6280-14821-62	6282-14821-61	6282-14821-62	6285-14821-61	6285-14821-62
	Basket	Black	6280-14821-81	6280-14821-82	6282-14821-81	6282-14821-82	6285-14821-81	6285-14821-82
	Hi Gloss	Black	6280-14821-91	6280-14821-92	6282-14821-91	6282-14821-92	6285-14821-91	6285-14821-92
	STX Tactical	Black	6280-14821-131	6280-14821-132	6282-14821-131	6282-14821-132	6285-14821-131	6285-14821-132
Springfield Armory XD, 9mm, .40, .45, .357 5" BBL	Plain	Black	6280-149-61	6280-149-62	6282-149-61	6282-149-62	6285-149-61	6285-149-62
	Basket	Black	6280-149-81	6280-149-82	6282-149-81	6282-149-82	6285-149-81	6285-149-82
	Hi Gloss	Black	6280-149-91	6280-149-92	6282-149-91	6282-149-92	6285-149-91	6285-149-92
	STX Tactical	Black	6280-149-131	6280-149-132	6282-149-131	6282-149-132	6285-149-131	6285-149-132
Springfield Armory XD 9mm, .40, .45, .357 w/ ITI M3/M6, TLR-1/TLR-2, Insight XT1 Procyon, SureFire X200/X300/X300U, or LAS-TAC2 5" BBL	Plain	Black	6280-14921-61	6280-14921-62	6282-14921-61	6282-14921-62	6285-14921-61	6285-14921-62
	Basket	Black	6280-14921-81	6280-14921-82	6282-14921-81	6282-14921-82	6285-14921-81	6285-14921-82
	Hi Gloss	Black	6280-14921-91	6280-14921-92	6282-14921-91	6282-14921-92	6285-14921-91	6285-14921-92
	STX Tactical	Black	6280-14921-131	6280-14921-132	6282-14921-131	6282-14921-132	6285-14921-131	6285-14921-132
Springfield Armory XD(M) 9mm, .40, .45 4.5" BBL	Plain	Black	6280-149-61	6280-149-62	6282-149-61	6282-149-62	6285-149-61	6285-149-62
	Basket	Black	6280-149-81	6280-149-82	6282-149-81	6282-149-82	6285-149-81	6285-149-82
	Hi Gloss	Black	6280-149-91	6280-149-92	6282-149-91	6282-149-92	6285-149-91	6285-149-92
	STX Tactical	Black	6280-149-131	6280-149-132	6282-149-131	6282-149-132	6285-149-131	6285-149-132
Springfield Armory XD(M) 9mm 3.8" BBL	Plain	Black	6280-148-61	6280-148-62	6282-148-61	6282-148-62	6285-148-61	6285-148-62
	Basket	Black	6280-148-81	6280-148-82	6282-148-81	6282-148-82	6285-148-81	6285-148-82
	Hi Gloss	Black	6280-148-91	6280-148-92	6282-148-91	6282-148-92	6285-148-91	6285-148-92
	STX Tactical	Black	6280-148-131	6280-148-132	6282-148-131	6282-148-132	6285-148-131	6285-148-132
Springfield Armory 1911-A1 5" BBL	Plain	Black	6280-53-61	6280-53-62	6282-53-61	6282-53-62	6285-53-61	6285-53-62
	Basket	Black	6280-53-81	6280-53-82	6282-53-81	6282-53-82	6285-53-81	6285-53-82
	Hi Gloss	Black	6280-53-91	6280-53-92	6282-53-91	6282-53-92	6285-53-91	6285-53-92
	STX Tactical	Black	6280-53-131	6280-53-132	6282-53-131	6282-53-132	6285-53-131	6285-53-132
Springfield Armory Operator 1911-A1 w/ SureFire X200/X300/X300U 5" BBL	Plain	Black	6280-5340-61	6280-5340-62	6282-5340-61	6282-5340-62	6285-5340-61	6285-5340-62
	Basket	Black	6280-5340-81	6280-5340-82	6282-5340-81	6282-5340-82	6285-5340-81	6285-5340-82
	Hi Gloss	Black	6280-5340-91	6280-5340-92	6282-5340-91	6282-5340-92	6285-5340-91	6285-5340-92
	STX Tactical	Black	6280-5340-131	6280-5340-132	6282-5340-131	6282-5340-132	6285-5340-131	6285-5340-132
Springfield Armory Operator 1911-A1 Model PX9105L w/ Picatinny Light Rail 5" BBL	Plain	Black	6280-56-61	6280-56-62	6282-56-61	6282-56-62	6285-56-61	6285-56-62
	Basket	Black	6280-56-81	6280-56-82	6282-56-81	6282-56-82	6285-56-81	6285-56-82
	Hi Gloss	Black	6280-56-91	6280-56-92	6282-56-91	6282-56-92	6285-56-91	6285-56-92
	STX Tactical	Black	6280-56-131	6280-56-132	6282-56-131	6282-56-132	6285-56-131	6285-56-132
Springfield Armory Operator 1911-A1 w/ ITI M3X/M6X 5" BBL	Plain	Black	6280-5612-61	6280-5612-62	6282-5612-61	6282-5612-62	6285-5612-61	6285-5612-62
	Basket	Black	6280-5612-81	6280-5612-82	6282-5612-81	6282-5612-82	6285-5612-81	6285-5612-82
	Hi Gloss	Black	6280-5612-91	6280-5612-92	6282-5612-91	6282-5612-92	6285-5612-91	6285-5612-92
	STX Tactical	Black	6280-5612-131	6280-5612-132	6282-5612-131	6282-5612-132	6285-5612-131	6285-5612-132
Springfield Armory Operator w/ Light Rail 1911-A1 Model PX9105L w/ ITI M3/M6 5" BBL	Plain	Black	6280-5621-61	6280-5621-62	6282-5621-61	6282-5621-62	6285-5621-61	6285-5621-62
	Basket	Black	6280-5621-81	6280-5621-82	6282-5621-81	6282-5621-82	6285-5621-81	6285-5621-82
	Hi Gloss	Black	6280-5621-91	6280-5621-92	6282-5621-91	6282-5621-92	6285-5621-91	6285-5621-92
	STX Tactical	Black	6280-5621-131	6280-5621-132	6282-5621-131	6282-5621-132	6285-5621-131	6285-5621-132
Steyr M40 4" BBL	Plain	Black	6280-98-61	6280-98-62	6282-98-61	6282-98-62	6285-98-61	6285-98-62
	Basket	Black	6280-98-81	6280-98-82	6282-98-81	6282-98-82	6285-98-81	6285-98-82
	Hi Gloss	Black	6280-98-91	6280-98-92	6282-98-91	6282-98-92	6285-98-91	6285-98-92
	STX Tactical	Black	6280-98-131	6280-98-132	6282-98-131	6282-98-132	6285-98-131	6285-98-132
STI/SVI 1911 5" BBL	Plain	Black	6280-56-61	6280-56-62	6282-56-61	6282-56-62	6285-56-61	6285-56-62
	Basket	Black	6280-56-81	6280-56-82	6282-56-81	6282-56-82	6285-56-81	6285-56-82
	Hi Gloss	Black	6280-56-91	6280-56-92	6282-56-91	6282-56-92	6285-56-91	6285-56-92
	STX Tactical	Black	6280-56-131	6280-56-132	6282-56-131	6282-56-132	6285-56-131	6285-56-132
STI/SVI 1911 w/ SureFire X200/X300/X300U 5" BBL	Plain	Black	6280-5340-61	6280-5340-62	6282-5340-61	6282-5340-62	6285-5340-61	6285-5340-62
	Basket	Black	6280-5340-81	6280-5340-82	6282-5340-81	6282-5340-82	6285-5340-81	6285-5340-82
	Hi Gloss	Black	6280-5340-91	6280-5340-92	6282-5340-91	6282-5340-92	6285-5340-91	6285-5340-92
	STX Tactical	Black	6280-5340-131	6280-5340-132	6282-5340-131	6282-5340-132	6285-5340-131	6285-5340-132
Stinger S-200	Plain	Black	6280-164-61	6280-164-62	6282-164-61	6282-164-62	6285-164-61	6285-164-62
	Basket	Black	6280-164-81	6280-164-82	6282-164-81	6282-164-82	6285-164-81	6285-164-82
	Hi Gloss	Black	6280-164-91	6280-164-92	6282-164-91	6282-164-92	6285-164-91	6285-164-92
	STX Tactical	Black	6280-164-131	6280-164-132	6282-164-131	6282-164-132	6285-164-131	6285-164-132
Tangfolio Force 4.4" BBL	Plain	Black	6280-262-61	6280-262-62	6282-262-61	6282-262-62	6285-262-61	6285-262-62
	Basket	Black	6280-262-81	6280-262-82	6282-262-81	6282-262-82	6285-262-81	6285-262-82
	Hi Gloss	Black	6280-262-91	6280-262-92	6282-262-91	6282-262-92	6285-262-91	6285-262-92
	STX Tactical	Black	6280-262-131	6280-262-132	6282-262-131	6282-262-132	6285-262-131	6285-262-132



Duty Holsters

6280/6282/6285 SLS LEVEL II RETENTION™ HOLSTERS FOR: PISTOLS (continued)

How to Order
 Duty Holsters
 Duty Accessories
 Tactical Holsters
 Tactical Accessories
 Duty Belts
 QAS
 Speed Loaders
 Light Systems
 Concealment Holsters
 Concealment Accessories
 Competition
 Apparel
 Sales Support
 Index/Price List

GUN DESCRIPTION	FINISH*	COLOR	6280 MID-RIDE		6282 HI-RIDE		6285 LOW-RIDE	
			RIGHT	LEFT	RIGHT	LEFT	RIGHT	LEFT
Taser® Advanced Taser M26	Plain	Black	6280-63-61	6280-63-62	6282-63-61	6282-63-62	6285-63-61	6285-63-62
	Basket	Black	6280-63-81	6280-63-82	6282-63-81	6282-63-82	6285-63-81	6285-63-82
	Hi Gloss	Black	6280-63-91	6280-63-92	6282-63-91	6282-63-92	6285-63-91	6285-63-92
	STX Tactical	Black	6280-63-131	6280-63-132	6282-63-131	6282-63-132	6285-63-131	6285-63-132
Taser® X3	Plain	Black	6280-163-61	6280-163-62	6282-163-61	6282-163-62	6285-163-61	6285-163-62
	Basket	Black	6280-163-81	6280-163-82	6282-163-81	6282-163-82	6285-163-81	6285-163-82
	Hi Gloss	Black	6280-163-91	6280-163-92	6282-163-91	6282-163-92	6285-163-91	6285-163-92
	STX Tactical	Black	6280-163-131	6280-163-132	6282-163-131	6282-163-132	6285-163-131	6285-163-132
Taser® X26	Plain	Black	6280-64-61	6280-64-62	6282-64-61	6282-64-62	6285-64-61	6285-64-62
	Basket	Black	6280-64-81	6280-64-82	6282-64-81	6282-64-82	6285-64-81	6285-64-82
	Hi Gloss	Black	6280-64-91	6280-64-92	6282-64-91	6282-64-92	6285-64-91	6285-64-92
	STX Tactical	Black	6280-64-131	6280-64-132	6282-64-131	6282-64-132	6285-64-131	6285-64-132
Walther P5 3.5" BBL	Plain	Black	6280-87-61	6280-87-62	6282-87-61	6282-87-62	6285-87-61	6285-87-62
	Basket	Black	6280-87-81	6280-87-82	6282-87-81	6282-87-82	6285-87-81	6285-87-82
	Hi Gloss	Black	6280-87-91	6280-87-92	6282-87-91	6282-87-92	6285-87-91	6285-87-92
	STX Tactical	Black	6280-87-131	6280-87-132	6282-87-131	6282-87-132	6285-87-131	6285-87-132
Walther P99 4" BBL	Plain	Black	6280-84-61	6280-84-62	6282-84-61	6282-84-62	6285-84-61	6285-84-62
	Basket	Black	6280-84-81	6280-84-82	6282-84-81	6282-84-82	6285-84-81	6285-84-82
	Hi Gloss	Black	6280-84-91	6280-84-92	6282-84-91	6282-84-92	6285-84-91	6285-84-92
	STX Tactical	Black	6280-84-131	6280-84-132	6282-84-131	6282-84-132	6285-84-131	6285-84-132
Walther P99C QA 3.375" BBL	Plain	Black	6280-84-61	6280-84-62	6282-84-61	6282-84-62	6285-84-61	6285-84-62
	Basket	Black	6280-84-81	6280-84-82	6282-84-81	6282-84-82	6285-84-81	6285-84-82
	Hi Gloss	Black	6280-84-91	6280-84-92	6282-84-91	6282-84-92	6285-84-91	6285-84-92
	STX Tactical	Black	6280-84-131	6280-84-132	6282-84-131	6282-84-132	6285-84-131	6285-84-132
Walther PPQ 4" BBL	Plain	Black	6280-384-61	6280-384-62	6282-384-61	6282-384-62	6285-384-61	6285-384-62
	Basket	Black	6280-384-81	6280-384-82	6282-384-81	6282-384-82	6285-384-81	6285-384-82
	Hi Gloss	Black	6280-384-91	6280-384-92	6282-384-91	6282-384-92	6285-384-91	6285-384-92
	STX Tactical	Black	6280-384-131	6280-384-132	6282-384-131	6282-384-132	6285-384-131	6285-384-132
Wilson Combat 1911 4.875" BBL	Plain	Black	6280-53-61	6280-53-62	6282-53-61	6282-53-62	6285-53-61	6285-53-62
	Basket	Black	6280-53-81	6280-53-82	6282-53-81	6282-53-82	6285-53-81	6285-53-82
	Hi Gloss	Black	6280-53-91	6280-53-92	6282-53-91	6282-53-92	6285-53-91	6285-53-92
	STX Tactical	Black	6280-53-131	6280-53-132	6282-53-131	6282-53-132	6285-53-131	6285-53-132
Wilson Combat CQB w/ SureFire X200/X300/X300U 5" BBL	Plain	Black	6280-5340-61	6280-5340-62	6282-5340-61	6282-5340-62	6285-5340-61	6285-5340-62
	Basket	Black	6280-5340-81	6280-5340-82	6282-5340-81	6282-5340-82	6285-5340-81	6285-5340-82
	Hi Gloss	Black	6280-5340-91	6280-5340-92	6282-5340-91	6282-5340-92	6285-5340-91	6285-5340-92
	STX Tactical	Black	6280-5340-131	6280-5340-132	6282-5340-131	6282-5340-132	6285-5340-131	6285-5340-132
SLS Hood Guard		Black	6000-1	6000-2				
SLS Sentry		Black	6001-1	6001-2				
SLS Hood Guard/Sentry		Black	6002-1	6002-2				

Duty Holsters



6280/6282/6285 SLS LEVEL II RETENTION™ HOLSTERS FOR: REVOLVERS



6280 MID-RIDE



6282 HI-RIDE



6285 LOW-RIDE

FEATURES

- ▶ Level II Retention™ holster
- ▶ SLS (Self Locking System) Rotating Hood
- ▶ Top draw and straight drop cant
- ▶ For pistols or revolvers
- ▶ Level III Retention™ with optional Sentry installed
- ▶ Offered in 2" (50mm) or 2.25" (58mm) belt slots
- ▶ Available in Plain Black, Basketweave, Hi Gloss, Nylon Look, STX finishes and STX Tactical® (all colors)
- ▶ Safariland offers training DVDs for various products. For more information on retention levels and this product please review TV-1004D, TV-1007D and TV-1015D

*Available in these additional STX finishes:

Sample Code 280-09-411	STX Basket 6280-XX-48X
STX Plain 6280-XX-41X	STX Hi Gloss 6280-XX-49X

6000

6001

6002

Safariland offers three uniquely designed accessories for the SLS holster system, the 6000 hood Guard, the 6001 Sentry (converting the holster to a higher level of security) and the 6002 hood guard/Sentry combination. Available for SLS models including 6004, 6005, 6034, 6035, 6230, 6235, 6280, 6282, 6287, 7004, 7005, 7280, 7282, 7285, and the 7287. ALS Series SLS holsters including the 6360, 6362, 6365, 6304, 6305, 6354, 6355, 6367, 7304, 7305, 7360, 7362, 7365 and the 7367.

Sample Code with Hood Guard installed:
6285-09-61-H

Sample Code with Sentry installed:
6285-09-61-S

Sample Code with Hood Guard/Sentry installed:
6285-09-61-SH



Duty Holsters

6280/6282/6285 SLS LEVEL II RETENTION™ HOLSTERS FOR: REVOLVERS (continued)

GUN DESCRIPTION	FINISH*	COLOR	6280 MID-RIDE		6282 HI-RIDE		6285 LOW-RIDE	
			RIGHT	LEFT	RIGHT	LEFT	RIGHT	LEFT
Ruger Security Six, Service Six, Speed Six 4" BBL	Plain	Black	6280-09-61	6280-09-62	6282-09-61	6282-09-62	6285-09-61	6285-09-62
	Basket	Black	6280-09-81	6280-09-82	6282-09-81	6282-09-82	6285-09-81	6285-09-82
	Hi Gloss	Black	6280-09-91	6280-09-92	6282-09-91	6282-09-92	6285-09-91	6285-09-92
	STX Tactical	Black	6280-09-131	6280-09-132	6282-09-131	6282-09-132	6285-09-131	6285-09-132
Smith & Wesson 10, 12, 13, 15, 19, 64, 65, 66, 67, 617, 648 K Medium Frame 4" BBL	Plain	Black	6280-09-61	6280-09-62	6282-09-61	6282-09-62	6285-09-61	6285-09-62
	Basket	Black	6280-09-81	6280-09-82	6282-09-81	6282-09-82	6285-09-81	6285-09-82
	Hi Gloss	Black	6280-09-91	6280-09-92	6282-09-91	6282-09-92	6285-09-91	6285-09-92
	STX Tactical	Black	6280-09-131	6280-09-132	6282-09-131	6282-09-132	6285-09-131	6285-09-132
Smith & Wesson 581, 586, 681, 686 L Medium Frame 4" BBL	Plain	Black	6280-21-61	6280-21-62	6282-21-61	6282-21-62	6285-21-61	6285-21-62
	Basket	Black	6280-21-81	6280-21-82	6282-21-81	6282-21-82	6285-21-81	6285-21-82
	Hi Gloss	Black	6280-21-91	6280-21-92	6282-21-91	6282-21-92	6285-21-91	6285-21-92
	STX Tactical	Black	6280-21-131	6280-21-132	6282-21-131	6282-21-132	6285-21-131	6285-21-132

SLS Hood Guard	Black	6000-1	6000-2
SLS Sentry	Black	6001-1	6001-2
SLS Hood Guard/Sentry	Black	6002-1	6002-2

- How to Order
- Duty Holsters
- Duty Accessories
- Tactical Holsters
- Tactical Accessories
- Duty Belts
- QAS
- Speed Loaders
- Light Systems
- Concealment Holsters
- Concealment Accessories
- Competition
- Apparel
- Sales Support
- Index/Price List

Duty Holsters

6280/6282/6285 RDS SLS LEVEL II RETENTION™ DUTY HOLSTERS



6280 MID-RIDE



6282 HI-RIDE



6285 LOW-RIDE

FEATURES

- ▶ SLS® (Self Locking Systems) Rotating Hood
- ▶ Suede lined to protect handgun's finish
- ▶ For use with red dot optic-equipped weapons
- ▶ Available in Cordura® Nylon, MultiCam®, Ranger Green, Coyote, Khaki, or Black finishes.
- ▶ SafariLaminate™ thermal-molded construction protects handgun and sights
- ▶ Optic Hood Cover (optional)

GUN DESCRIPTION	FINISH*	COLOR	6280RDS MID-RIDE		6282RDS HI-RIDE		6285RDS LOW-RIDE	
			RIGHT	LEFT	RIGHT	LEFT	RIGHT	LEFT
Glock 17/22 w/ ITI M3 Light, TLR-1, TLR-1HL, TLR-2, TLR-2HL, SureFire X200/X300/X300U 4.5" BBL	Cordura®	MultiCam®	6280RDS-832-701	6280RDS-832-702	6282RDS-832-701	6282RDS-832-702	6285RDS-832-701	6285RDS-832-702
	Cordura®	Ranger Green	6280RDS-832-731	6280RDS-832-732	6282RDS-832-731	6282RDS-832-732	6285RDS-832-731	6285RDS-832-732
	Cordura®	Coyote	6280RDS-832-741	6280RDS-832-742	6282RDS-832-741	6282RDS-832-742	6285RDS-832-741	6285RDS-832-742
	Cordura®	Khaki	6280RDS-832-751	6280RDS-832-752	6282RDS-832-751	6282RDS-832-752	6285RDS-832-751	6285RDS-832-752
	Cordura®	Black	6280RDS-832-781	6280RDS-832-782	6282RDS-832-781	6282RDS-832-782	6285RDS-832-781	6285RDS-832-782
	Tactical	Black	6280RDS-832-131	6280RDS-832-132	6282RDS-832-131	6282RDS-832-132	6285RDS-832-131	6285RDS-832-132
Glock 19/23 w/ITI M3 Light, TLR-1, TLR-1HL, SureFire X200/X300/X300U 4" BBL	Cordura®	MultiCam®	6280RDS-2832-701	6280RDS-2832-702	6282RDS-2832-701	6282RDS-2832-702	6285RDS-2832-701	6285RDS-2832-702
	Cordura®	Ranger Green	6280RDS-2832-731	6280RDS-2832-732	6282RDS-2832-731	6282RDS-2832-732	6285RDS-2832-731	6285RDS-2832-732
	Cordura®	Coyote	6280RDS-2832-741	6280RDS-2832-742	6282RDS-2832-741	6282RDS-2832-742	6285RDS-2832-741	6285RDS-2832-742
	Cordura®	Khaki	6280RDS-2832-751	6280RDS-2832-752	6282RDS-2832-751	6282RDS-2832-752	6285RDS-2832-751	6285RDS-2832-752
	Cordura®	Black	6280RDS-2832-781	6280RDS-2832-782	6282RDS-2832-781	6282RDS-2832-782	6285RDS-2832-781	6285RDS-2832-782
	Tactical	Black	6280RDS-2832-131	6280RDS-2832-132	6282RDS-2832-131	6282RDS-2832-132	6285RDS-2832-131	6285RDS-2832-132
Glock 34/35 w/ITI M3 Light, TLR-1, TLR-1HL, SureFire X200/X300/X300U 5.32" BBL	Cordura®	MultiCam®	6280RDS-6832-701	6280RDS-6832-702	6282RDS-6832-701	6282RDS-6832-702	6285RDS-6832-701	6285RDS-6832-702
	Cordura®	Ranger Green	6280RDS-6832-731	6280RDS-6832-732	6282RDS-6832-731	6282RDS-6832-732	6285RDS-6832-731	6285RDS-6832-732
	Cordura®	Coyote	6280RDS-6832-741	6280RDS-6832-742	6282RDS-6832-741	6282RDS-6832-742	6285RDS-6832-741	6285RDS-6832-742
	Cordura®	Khaki	6280RDS-6832-751	6280RDS-6832-752	6282RDS-6832-751	6282RDS-6832-752	6285RDS-6832-751	6285RDS-6832-752
	Cordura®	Black	6280RDS-6832-781	6280RDS-6832-782	6282RDS-6832-781	6282RDS-6832-782	6285RDS-6832-781	6285RDS-6832-782
	Tactical	Black	6280RDS-6832-131	6280RDS-6832-132	6282RDS-6832-131	6282RDS-6832-132	6285RDS-6832-131	6285RDS-6832-132
Smith & Wesson M&P 9mm, .40 w/ITI M3 Light, TLR-1, TLR-1HL, SureFire X200/X300/X300U 4.25" BBL	Cordura®	MultiCam®	6280RDS-2192-701	6280RDS-2192-702	6282RDS-2192-701	6282RDS-2192-702	6285RDS-2192-701	6285RDS-2192-702
	Cordura®	Ranger Green	6280RDS-2192-731	6280RDS-2192-732	6282RDS-2192-731	6282RDS-2192-732	6285RDS-2192-731	6285RDS-2192-732
	Cordura®	Coyote	6280RDS-2192-741	6280RDS-2192-742	6282RDS-2192-741	6282RDS-2192-742	6285RDS-2192-741	6285RDS-2192-742
	Cordura®	Khaki	6280RDS-2192-751	6280RDS-2192-752	6282RDS-2192-751	6282RDS-2192-752	6285RDS-2192-751	6285RDS-2192-752
	Cordura®	Black	6280RDS-2192-781	6280RDS-2192-782	6282RDS-2192-781	6282RDS-2192-782	6285RDS-2192-781	6285RDS-2192-782
	Tactical	Black	6280RDS-2192-131	6280RDS-2192-132	6282RDS-2192-131	6282RDS-2192-132	6285RDS-2192-131	6285RDS-2192-132
Smith & Wesson M&P C.O.R.E. w/ITI M3 Light, TLR-1, TLR-1HL, SureFire X200/X300/X300U 5" BBL	Cordura®	MultiCam®	6280RDS-8192-701	6280RDS-8192-702	6282RDS-8192-701	6282RDS-8192-702	6285RDS-8192-701	6285RDS-8192-702
	Cordura®	Ranger Green	6280RDS-8192-731	6280RDS-8192-732	6282RDS-8192-731	6282RDS-8192-732	6285RDS-8192-731	6285RDS-8192-732
	Cordura®	Coyote	6280RDS-8192-741	6280RDS-8192-742	6282RDS-8192-741	6282RDS-8192-742	6285RDS-8192-741	6285RDS-8192-742
	Cordura®	Khaki	6280RDS-8192-751	6280RDS-8192-752	6282RDS-8192-751	6282RDS-8192-752	6285RDS-8192-751	6285RDS-8192-752
	Cordura®	Black	6280RDS-8192-781	6280RDS-8192-782	6282RDS-8192-781	6282RDS-8192-782	6285RDS-8192-781	6285RDS-8192-782
	Tactical	Black	6280RDS-8192-131	6280RDS-8192-132	6282RDS-8192-131	6282RDS-8192-132	6285RDS-8192-131	6285RDS-8192-132



Duty Holsters

6390/6392/6395 ALS® LEVEL I RETENTION™ HOLSTERS FOR: PISTOLS



PATENTED

6390 MID-RIDE



PATENTED

6392 HI-RIDE



PATENTED

6395 LOW-RIDE

FEATURES

- ▶ Level I Retention™ holster
- ▶ ALS® (Automatic Locking System) secures weapon once holstered; simple straight up draw once the release is deactivated
- ▶ Hood Guard comes standard
- ▶ Open-top design without SLS for quick retrieval of weapon
- ▶ SafariLaminate™ thermal-molded construction protects handgun and sights
- ▶ Optional ALS Guard available for extra security and Level II Retention™ holster upgrade
- ▶ Offered in 2" (50mm) or 2.25" (58mm) belt slots
- ▶ Available in STX Plain, STX Basketweave, STX Hi Gloss and STX Tactical® finishes
- ▶ Safariland offers training DVDs for various products. For more information on retention levels and this product please review TV-1012D, TV-1007D and TV-1015D

Models 6390/6392/6395 Duty Holsters include installed Hood Guard
 Sample Code with ALS Guard Only:
 6390-83-4II-AG
 Sample Code with Hood Guard & ALS Guard:
 6390-83-4II-AGH



ALS Guard – Unlocked

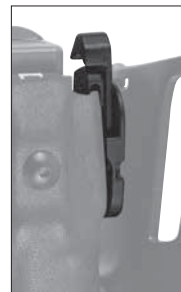

ALS Guard – Locked

GUN DESCRIPTION	FINISH	COLOR	6390 MID-RIDE		6392 HI-RIDE		6395 LOW-RIDE	
			RIGHT	LEFT	RIGHT	LEFT	RIGHT	LEFT
Beretta APX 9mm, .40 S&W 4.25" BBL	STX Plain	Black	6390-677-411	6390-677-412	6392-677-411	6392-677-412	6395-677-411	6395-677-412
	STX Basket	Black	6390-677-481	6390-677-482	6392-677-481	6392-677-482	6395-677-481	6395-677-482
	STX Hi Gloss	Black	6390-677-491	6390-677-492	6392-677-491	6392-677-492	6395-677-491	6395-677-492
	STX Tactical	Black	6390-677-131	6390-677-132	6392-677-131	6392-677-132	6395-677-131	6395-677-132
Beretta Px4 Storm 9mm, .40 4" BBL	STX Plain	Black	6390-180-411	6390-180-412	6392-180-411	6392-180-412	6395-180-411	6395-180-412
	STX Basket	Black	6390-180-481	6390-180-482	6392-180-481	6392-180-482	6395-180-481	6395-180-482
	STX Hi Gloss	Black	6390-180-491	6390-180-492	6392-180-491	6392-180-492	6395-180-491	6395-180-492
	STX Tactical	Black	6390-180-131	6390-180-132	6392-180-131	6392-180-132	6395-180-131	6395-180-132
Beretta 92F, 92FS, 92G, 96, 96G 4.9" BBL	STX Plain	Black	6390-73-411	6390-73-412	6392-73-411	6392-73-412	6395-73-411	6395-73-412
	STX Basket	Black	6390-73-481	6390-73-482	6392-73-481	6392-73-482	6395-73-481	6395-73-482
	STX Hi Gloss	Black	6390-73-491	6390-73-492	6392-73-491	6392-73-492	6395-73-491	6395-73-492
	STX Tactical	Black	6390-73-131	6390-73-132	6392-73-131	6392-73-132	6395-73-131	6395-73-132
Colt Government 1911 5" BBL	STX Plain	Black	6390-53-411	6390-53-412	6392-53-411	6392-53-412	6395-53-411	6395-53-412
	STX Basket	Black	6390-53-481	6390-53-482	6392-53-481	6392-53-482	6395-53-481	6395-53-482
	STX Hi Gloss	Black	6390-53-491	6390-53-492	6392-53-491	6392-53-492	6395-53-491	6395-53-492
	STX Tactical	Black	6390-53-131	6390-53-132	6392-53-131	6392-53-132	6395-53-131	6395-53-132
FN FNS 9mm/.40 4" BBL	STX Plain	Black	6390-266-411	6390-266-412	6392-266-411	6392-266-412	6395-266-411	6395-266-412
	STX Basket	Black	6390-266-481	6390-266-482	6392-266-481	6392-266-482	6395-266-481	6395-266-482
	STX Hi Gloss	Black	6390-266-491	6390-266-492	6392-266-491	6392-266-492	6395-266-491	6395-266-492
	STX Tactical	Black	6390-266-131	6390-266-132	6392-266-131	6392-266-132	6395-266-131	6395-266-132

How to Order
 Duty Holsters
 Duty Accessories
 Tactical Holsters
 Tactical Accessories
 Duty Belts
 QAS
 Speed Loaders
 Light Systems
 Concealment Holsters
 Concealment Accessories
 Competition
 Apparel
 Sales Support
 Index/Price List

Duty Holsters



6390/6392/6395 ALS® LEVEL I RETENTION™ HOLSTERS FOR: PISTOLS (continued)

How to Order
Duty Holsters
Duty Accessories
Tactical Holsters
Tactical Accessories
Duty Belts
OAS
Speed Loaders
Light Systems
Concealment Holsters
Concealment Accessories
Competition
Apparel
Sales Support
Index/Price List

GUN DESCRIPTION	FINISH	COLOR	6390 MID-RIDE		6392 HI-RIDE		6395 LOW-RIDE	
			RIGHT	LEFT	RIGHT	LEFT	RIGHT	LEFT
Glock 17, 22 4.5" BBL	STX Plain	Black	6390-83-411	6390-83-412	6392-83-411	6392-83-412	6395-83-411	6395-83-412
	STX Basket	Black	6390-83-481	6390-83-482	6392-83-481	6392-83-482	6395-83-481	6395-83-482
	STX Hi Gloss	Black	6390-83-491	6390-83-492	6392-83-491	6392-83-492	6395-83-491	6395-83-492
	STX Tactical	Black	6390-83-131	6390-83-132	6392-83-131	6392-83-132	6395-83-131	6395-83-132
Glock 17, 22 w/ ITI M3 Light, TLR-1, TLR-1HL SureFire X200/X300/X300U 4.5" BBL	STX Plain	Black	6390-832-411	6390-832-412	6392-832-411	6392-832-412	6395-832-411	6395-832-412
	STX Basket	Black	6390-832-481	6390-832-482	6392-832-481	6392-832-482	6395-832-481	6395-832-482
	STX Hi Gloss	Black	6390-832-491	6390-832-492	6392-832-491	6392-832-492	6395-832-491	6395-832-492
	STX Tactical	Black	6390-832-131	6390-832-132	6392-832-131	6392-832-132	6395-832-131	6395-832-132
Glock 17, 22 w/ GTL-10 Light Only GTL 21/22 Light/ Laser Combination GTL 51/52 Light/ Laser Combintion 4.5" BBL	STX Plain	Black	6390-8310-411	6390-8310-412	6392-8310-411	6392-8310-412	6395-8310-411	6395-8310-412
	STX Basket	Black	6390-8310-481	6390-8310-482	6392-8310-481	6392-8310-482	6395-8310-481	6395-8310-482
	STX Hi Gloss	Black	6390-8310-491	6390-8310-492	6392-8310-491	6392-8310-492	6395-8310-491	6395-8310-492
	STX Tactical	Black	6390-8310-131	6390-8310-132	6392-8310-131	6392-8310-132	6395-8310-131	6395-8310-132
Glock 19, 23 4" BBL 26, 27 3.5" BBL	STX Plain	Black	6390-283-411	6390-283-412	6392-283-411	6392-283-412	6395-283-411	6395-283-412
	STX Basket	Black	6390-283-481	6390-283-482	6392-283-481	6392-283-482	6395-283-481	6395-283-482
	STX Hi Gloss	Black	6390-283-491	6390-283-492	6392-283-491	6392-283-492	6395-283-491	6395-283-492
	STX Tactical	Black	6390-283-131	6390-283-132	6392-283-131	6392-283-132	6395-283-131	6395-283-132
Glock 19, 23 w/ ITI M3, TLR-1, TLR-1HL SureFire X200/X300/X300U 4" BBL	STX Plain	Black	6390-2832-411	6390-2832-412	6392-2832-411	6392-2832-412	6395-2832-411	6395-2832-412
	STX Basket	Black	6390-2832-481	6390-2832-482	6392-2832-481	6392-2832-482	6395-2832-481	6395-2832-482
	STX Hi Gloss	Black	6390-2832-491	6390-2832-492	6392-2832-491	6392-2832-492	6395-2832-491	6395-2832-492
	STX Tactical	Black	6390-2832-131	6390-2832-132	6392-2832-131	6392-2832-132	6395-2832-131	6395-2832-132
Glock 20, 21 4.6" BBL	STX Plain	Black	6390-383-411	6390-383-412	6392-383-411	6392-383-412	6395-383-411	6395-383-412
	STX Basket	Black	6390-383-481	6390-383-482	6392-383-481	6392-383-482	6395-383-481	6395-383-482
	STX Hi Gloss	Black	6390-383-491	6390-383-492	6392-383-491	6392-383-492	6395-383-491	6395-383-492
	STX Tactical	Black	6390-383-131	6390-383-132	6392-383-131	6392-383-132	6395-383-131	6395-383-132
Glock 20, 21 w/ ITI M3, TLR-1, TLR-1HL SureFire X200/X300/X300U 4.6" BBL	STX Plain	Black	6390-3832-411	6390-3832-412	6392-3832-411	6392-3832-412	6395-3832-411	6395-3832-412
	STX Basket	Black	6390-3832-481	6390-3832-482	6392-3832-481	6392-3832-482	6395-3832-481	6395-3832-482
	STX Hi Gloss	Black	6390-3832-491	6390-3832-492	6392-3832-491	6392-3832-492	6395-3832-491	6395-3832-492
	STX Tactical	Black	6390-3832-131	6390-3832-132	6392-3832-131	6392-3832-132	6395-3832-131	6395-3832-132
Glock 34, 35 5.32" BBL	STX Plain	Black	6390-683-411	6390-683-412	6392-683-411	6392-683-412	6395-683-411	6395-683-412
	STX Basket	Black	6390-683-481	6390-683-482	6392-683-481	6392-683-482	6395-683-481	6395-683-482
	STX Hi Gloss	Black	6390-683-491	6390-683-492	6392-683-491	6392-683-492	6395-683-491	6395-683-492
	STX Tactical	Black	6390-683-131	6390-683-132	6392-683-131	6392-683-132	6395-683-131	6395-683-132
Glock 34, 35 w/ ITI M3, TLR-1, TLR-1HL SureFire X200/X300/X300U 5.32" BBL	STX Plain	Black	6390-6832-411	6390-6832-412	6392-6832-411	6392-6832-412	6395-6832-411	6395-6832-412
	STX Basket	Black	6390-6832-481	6390-6832-482	6392-6832-481	6392-6832-482	6395-6832-481	6395-6832-482
	STX Hi Gloss	Black	6390-6832-491	6390-6832-492	6392-6832-491	6392-6832-492	6395-6832-491	6395-6832-492
	STX Tactical	Black	6390-6832-131	6390-6832-132	6392-6832-131	6392-6832-132	6395-6832-131	6395-6832-132
Glock 37 4.5" BBL	STX Plain	Black	6390-783-411	6390-783-412	6392-783-411	6392-783-412	6395-783-411	6395-783-412
	STX Basket	Black	6390-783-481	6390-783-482	6392-783-481	6392-783-482	6395-783-481	6395-783-482
	STX Hi Gloss	Black	6390-783-491	6390-783-492	6392-783-491	6392-783-492	6395-783-491	6395-783-492
	STX Tactical	Black	6390-783-131	6390-783-132	6392-783-131	6392-783-132	6395-783-131	6395-783-132
Glock 37 w/ ITI M3, TLR-1, TLR-1HL SureFire X200/X300/ X300U 4.5" BBL	STX Plain	Black	6390-7832-411	6390-7832-412	6392-7832-411	6392-7832-412	6395-7832-411	6395-7832-412
	STX Basket	Black	6390-7832-481	6390-7832-482	6392-7832-481	6392-7832-482	6395-7832-481	6395-7832-482
	STX Hi Gloss	Black	6390-7832-491	6390-7832-492	6392-7832-491	6392-7832-492	6395-7832-491	6395-7832-492
	STX Tactical	Black	6390-7832-131	6390-7832-132	6392-7832-131	6392-7832-132	6395-7832-131	6395-7832-132
Glock 41 5.31" BBL	STX Plain	Black	6390-893-411	6390-893-412	6392-893-411	6392-893-412	6395-893-411	6395-893-412
	STX Basket	Black	6390-893-481	6390-893-482	6392-893-481	6392-893-482	6395-893-481	6395-893-482
	STX Hi Gloss	Black	6390-893-491	6390-893-492	6392-893-491	6392-893-492	6395-893-491	6395-893-492
	STX Tactical	Black	6390-893-131	6390-893-132	6392-893-131	6392-893-132	6395-893-131	6395-893-132
Glock 41 w/ ITI M3, TLR-1, TLR-1HL SureFire X200/X300/X300U 5.31" BBL	STX Plain	Black	6390-8932-411	6390-8932-412	6392-8932-411	6392-8932-412	6395-8932-411	6395-8932-412
	STX Basket	Black	6390-8932-481	6390-8932-482	6392-8932-481	6392-8932-482	6395-8932-481	6395-8932-482
	STX Hi Gloss	Black	6390-8932-491	6390-8932-492	6392-8932-491	6392-8932-492	6395-8932-491	6395-8932-492
	STX Tactical	Black	6390-8932-131	6390-8932-132	6392-8932-131	6392-8932-132	6395-8932-131	6395-8932-132
Heckler & Koch P30 3.875" BBL	STX Plain	Black	6390-295-411	6390-295-412	6392-295-411	6392-295-412	6395-295-411	6395-295-412
	STX Basket	Black	6390-295-481	6390-295-482	6392-295-481	6392-295-482	6395-295-481	6395-295-482
	STX Hi Gloss	Black	6390-295-491	6390-295-492	6392-295-491	6392-295-492	6395-295-491	6395-295-492
	STX Tactical	Black	6390-295-131	6390-295-132	6392-295-131	6392-295-132	6395-295-131	6395-295-132
Heckler & Koch USP 9C 3.58" BBL	STX Plain	Black	6390-291-411	6390-291-412	6392-291-411	6392-291-412	6395-291-411	6395-291-412
	STX Basket	Black	6390-291-481	6390-291-482	6392-291-481	6392-291-482	6395-291-481	6395-291-482
	STX Hi Gloss	Black	6390-291-491	6390-291-492	6392-291-491	6392-291-492	6395-291-491	6395-291-492
	STX Tactical	Black	6390-291-131	6390-291-132	6392-291-131	6392-291-132	6395-291-131	6395-291-132



Duty Holsters

6390/6392/6395 ALS® LEVEL I RETENTION™ HOLSTERS FOR: PISTOLS (continued)

GUN DESCRIPTION	FINISH	COLOR	6390 MID-RIDE		6392 HI-RIDE		6395 LOW-RIDE	
			RIGHT	LEFT	RIGHT	LEFT	RIGHT	LEFT
Heckler & Koch USP 9mm, .40 4.25" BBL	STX Plain	Black	6390-91-411	6390-91-412	6392-91-411	6392-91-412	6395-91-411	6395-91-412
	STX Basket	Black	6390-91-481	6390-91-482	6392-91-481	6392-91-482	6395-91-481	6395-91-482
	STX Hi Gloss	Black	6390-91-491	6390-91-492	6392-91-491	6392-91-492	6395-91-491	6395-91-492
	STX Tactical	Black	6390-91-131	6390-91-132	6392-91-131	6392-91-132	6395-91-131	6395-91-132
Heckler & Koch USP 9/40 w/ TRL-3 4.25" BBL	STX Plain	Black	6390-29116-411	6390-29116-412	6392-29116-411	6392-29116-412	6395-29116-411	6395-29116-412
	STX Basket	Black	6390-29116-481	6390-29116-482	6392-29116-481	6392-29116-482	6395-29116-481	6395-29116-482
	STX Hi Gloss	Black	6390-29116-491	6390-29116-492	6392-29116-491	6392-29116-492	6395-29116-491	6395-29116-492
	STX Tactical	Black	6390-29116-131	6390-29116-132	6392-29116-131	6392-29116-132	6395-29116-131	6395-29116-132
Heckler & Koch P2000 3.5" BBL	STX Plain	Black	6390-97-411	6390-97-412	6392-97-411	6392-97-412	6395-97-411	6395-97-412
	STX Basket	Black	6390-97-481	6390-97-482	6392-97-481	6392-97-482	6395-97-481	6395-97-482
	STX Hi Gloss	Black	6390-97-491	6390-97-492	6392-97-491	6392-97-492	6395-97-491	6395-97-492
	STX Tactical	Black	6390-97-131	6390-97-132	6392-97-131	6392-97-132	6395-97-131	6395-97-132
Heckler & Koch P2000 US Version w/ ITI M3, TLR-1, TLR-1HL SureFire X200/X300/X300U 3.5" BBL	STX Plain	Black	6390-1972-411	6390-1972-412	6392-1972-411	6392-1972-412	6395-1972-411	6395-1972-412
	STX Basket	Black	6390-1972-481	6390-1972-482	6392-1972-481	6392-1972-482	6395-1972-481	6395-1972-482
	STX Hi Gloss	Black	6390-1972-491	6390-1972-492	6392-1972-491	6392-1972-492	6395-1972-491	6395-1972-492
	STX Tactical	Black	6390-1972-131	6390-1972-132	6392-1972-131	6392-1972-132	6395-1972-131	6395-1972-132
Heckler & Koch VP9 4.09" BBL	STX Plain	Black	6390-593-411	6390-593-412	6392-593-411	6392-593-412	6395-593-411	6395-593-412
	STX Basket	Black	6390-593-481	6390-593-482	6392-593-481	6392-593-482	6395-593-481	6395-593-482
	STX Hi Gloss	Black	6390-593-491	6390-593-492	6392-593-491	6392-593-492	6395-593-491	6395-593-492
	STX Tactical	Black	6390-593-131	6390-593-132	6392-593-131	6392-593-132	6395-593-131	6395-593-132
Heckler & Koch VP9 w/ ITI M3, TLR-1, TLR-1HL SureFire X200/X300/X300U 4.09" BBL	STX Plain	Black	6390-5932-411	6390-5932-412	6392-5932-411	6392-5932-412	6395-5932-411	6395-5932-412
	STX Basket	Black	6390-5932-481	6390-5932-482	6392-5932-481	6392-5932-482	6395-5932-481	6395-5932-482
	STX Hi Gloss	Black	6390-5932-491	6390-5932-492	6392-5932-491	6392-5932-492	6395-5932-491	6395-5932-492
	STX Tactical	Black	6390-5932-131	6390-5932-132	6392-5932-131	6392-5932-132	6395-5932-131	6395-5932-132
Sig Sauer P220, P226 4.41" BBL	STX Plain	Black	6390-77-411	6390-77-412	6392-77-411	6392-77-412	6395-77-411	6395-77-412
	STX Basket	Black	6390-77-481	6390-77-482	6392-77-481	6392-77-482	6395-77-481	6395-77-482
	STX Hi Gloss	Black	6390-77-491	6390-77-492	6392-77-491	6392-77-492	6395-77-491	6395-77-492
	STX Tactical	Black	6390-77-131	6390-77-132	6392-77-131	6392-77-132	6395-77-131	6395-77-132
Sig Sauer P220R, P226R w/ ITI M3, TLR-1, SureFire X200/X300 / X300U 4.41" BBL	STX Plain	Black	6390-7742-411	6390-7742-412	6392-7742-411	6392-7742-412	6395-7742-411	6395-7742-412
	STX Basket	Black	6390-7742-481	6390-7742-482	6392-7742-481	6392-7742-482	6395-7742-481	6395-7742-482
	STX Hi Gloss	Black	6390-7742-491	6390-7742-492	6392-7742-491	6392-7742-492	6395-7742-491	6395-7742-492
	STX Tactical	Black	6390-7742-131	6390-7742-132	6392-7742-131	6392-7742-132	6395-7742-131	6395-7742-132
Sig Sauer P220R DAK, P226R DAK w/ Bobbed Hammer P220R DA/SA, P226R DA/SA w/ Full Size Hammer 4.41" BBL	STX Plain	Black	6390-477-411	6390-477-412	6392-477-411	6392-477-412	6395-477-411	6395-477-412
	STX Basket	Black	6390-477-481	6390-477-482	6392-477-481	6392-477-482	6395-477-481	6395-477-482
	STX Hi Gloss	Black	6390-477-491	6390-477-492	6392-477-491	6392-477-492	6395-477-491	6395-477-492
	STX Tactical	Black	6390-477-131	6390-477-132	6392-477-131	6392-477-132	6395-477-131	6395-477-132
Sig Sauer P226R Elite 4.41" BBL	STX Plain	Black	6390-477-411	6390-477-412	6392-477-411	6392-477-412	6395-477-411	6395-477-412
	STX Basket	Black	6390-477-481	6390-477-482	6392-477-481	6392-477-482	6395-477-481	6395-477-482
	STX Hi Gloss	Black	6390-477-491	6390-477-492	6392-477-491	6392-477-492	6395-477-491	6395-477-492
	STX Tactical	Black	6390-477-131	6390-477-132	6392-477-131	6392-477-132	6395-477-131	6395-477-132
Sig Sauer P228, P229 3.9" BBL	STX Plain	Black	6390-74-411	6390-74-412	6392-74-411	6392-74-412	6395-74-411	6395-74-412
	STX Basket	Black	6390-74-481	6390-74-482	6392-74-481	6392-74-482	6395-74-481	6395-74-482
	STX Hi Gloss	Black	6390-74-491	6390-74-492	6392-74-491	6392-74-492	6395-74-491	6395-74-492
	STX Tactical	Black	6390-74-131	6390-74-132	6392-74-131	6392-74-132	6395-74-131	6395-74-132
Sig Sauer P229 w/ ITI M3, TLR-1, TLR-1HL SureFire X200/X300/ X300U 3.9" BBL	STX Plain	Black	6390-7442-411	6390-7442-412	6392-7442-411	6392-7442-412	6395-7442-411	6395-7442-412
	STX Basket	Black	6390-7442-481	6390-7442-482	6392-7442-481	6392-7442-482	6395-7442-481	6395-7442-482
	STX Hi Gloss	Black	6390-7442-491	6390-7442-492	6392-7442-491	6392-7442-492	6395-7442-491	6395-7442-492
	STX Tactical	Black	6390-7442-131	6390-7442-132	6392-7442-131	6392-7442-132	6395-7442-131	6395-7442-132
Sig Sauer P229R DAK .40 w/ Bobbed Hammer P229R DA/SA .40 w/ Full Size Hammer 3.9" BBL	STX Plain	Black	6390-447-411	6390-447-412	6392-447-411	6392-447-412	6395-447-411	6395-447-412
	STX Basket	Black	6390-447-481	6390-447-482	6392-447-481	6392-447-482	6395-447-481	6395-447-482
	STX Hi Gloss	Black	6390-447-491	6390-447-492	6392-447-491	6392-447-492	6395-447-491	6395-447-492
	STX Tactical	Black	6390-447-131	6390-447-132	6392-447-131	6392-447-132	6395-447-131	6395-447-132
Sig Sauer P320 9/40 4.7" BBL	STX Plain	Black	6390-450-411	6390-450-412	6392-450-411	6392-450-412	6395-450-411	6395-450-412
	STX Basket	Black	6390-450-481	6390-450-482	6392-450-481	6392-450-482	6395-450-481	6395-450-482
	STX Hi Gloss	Black	6390-450-491	6390-450-492	6392-450-491	6392-450-492	6395-450-491	6395-450-492
	STX Tactical	Black	6390-450-131	6390-450-132	6392-450-131	6392-450-132	6395-450-131	6395-450-132
Sig Sauer P320 9/40 w/ ITI M3, TLR-1, TLR-1HL SureFire X200/X300/X300U 4.7" BBL	STX Plain	Black	6390-4502-411	6390-4502-412	6392-4502-411	6392-4502-412	6395-4502-411	6395-4502-412
	STX Basket	Black	6390-4502-481	6390-4502-482	6392-4502-481	6392-4502-482	6395-4502-481	6395-4502-482
	STX Hi Gloss	Black	6390-4502-491	6390-4502-492	6392-4502-491	6392-4502-492	6395-4502-491	6395-4502-492
	STX Tactical	Black	6390-4502-131	6390-4502-132	6392-4502-131	6392-4502-132	6395-4502-131	6395-4502-132

How to Order
Duty Holsters
Duty Accessories
Tactical Holsters
Tactical Accessories
Duty Belts
DAS
Speed Loaders
Light Systems
Concealment Holsters
Concealment Accessories
Competition
Apparel
Sales Support
Index/ Price List

Duty Holsters



6390/6392/6395 ALS® LEVEL I RETENTION™ HOLSTERS FOR: PISTOLS (continued)

How to Order
Duty Holsters
Duty Accessories
Tactical Holsters
Tactical Accessories
Duty Belts
OAS
Speed Loaders
Light Systems
Concealment Holsters
Concealment Accessories
Competition
Apparel
Sales Support
Index/Price List

GUN DESCRIPTION	FINISH	COLOR	6390 MID-RIDE		6392 HI-RIDE		6395 LOW-RIDE	
			RIGHT	LEFT	RIGHT	LEFT	RIGHT	LEFT
Sig Sauer P320 Compact & Carry 9mm, .40 3.9" BBL	STX Plain	Black	6390-750-411	6390-750-412	6392-750-411	6392-750-412	6395-750-411	6395-750-412
	STX Basket	Black	6390-750-481	6390-750-482	6392-750-481	6392-750-482	6395-750-481	6395-750-482
	STX Hi Gloss	Black	6390-750-491	6390-750-492	6392-750-491	6392-750-492	6395-750-491	6395-750-492
	STX Tactical	Black	6390-750-131	6390-750-132	6392-750-131	6392-750-132	6395-750-131	6395-750-132
Sig Sauer P320 Compact & Carry 9mm, .40 w/ ITI M3, TLR-1, TLR-1HL SureFire X200/X300/X300U 4.7" BBL	STX Plain	Black	6390-7502-411	6390-7502-412	6392-7502-411	6392-7502-412	6395-7502-411	6395-7502-412
	STX Basket	Black	6390-7502-481	6390-7502-482	6392-7502-481	6392-7502-482	6395-7502-481	6395-7502-482
	STX Hi Gloss	Black	6390-7502-491	6390-7502-492	6392-7502-491	6392-7502-492	6395-7502-491	6395-7502-492
	STX Tactical	Black	6390-7502-131	6390-7502-132	6392-7502-131	6392-7502-132	6395-7502-131	6395-7502-132
Sig Sauer P320 Compact & Carry .45 3.9" BBL	STX Plain	Black	6390-751-411	6390-751-412	6392-751-411	6392-751-412	6395-751-411	6395-751-412
	STX Basket	Black	6390-751-481	6390-751-482	6392-751-481	6392-751-482	6395-751-481	6395-751-482
	STX Hi Gloss	Black	6390-751-491	6390-751-492	6392-751-491	6392-751-492	6395-751-491	6395-751-492
	STX Tactical	Black	6390-751-131	6390-751-132	6392-751-131	6392-751-132	6395-751-131	6395-751-132
Sig Sauer P320 Compact & Carry .45 w/ ITI M3, TLR-1, TLR-1HL SureFire X200/X300/X300U 3.9" BBL	STX Plain	Black	6390-7512-411	6390-7512-412	6392-7512-411	6392-7512-412	6395-7512-411	6395-7512-412
	STX Basket	Black	6390-7512-481	6390-7512-482	6392-7512-481	6392-7512-482	6395-7512-481	6395-7512-482
	STX Hi Gloss	Black	6390-7512-491	6390-7512-492	6392-7512-491	6392-7512-492	6395-7512-491	6395-7512-492
	STX Tactical	Black	6390-7512-131	6390-7512-132	6392-7512-131	6392-7512-132	6395-7512-131	6395-7512-132
Sig Sauer SP2022 3.87" BBL	STX Plain	Black	6390-278-411	6390-278-412	6392-278-411	6392-278-412	6395-278-411	6395-278-412
	STX Basket	Black	6390-278-481	6390-278-482	6392-278-481	6392-278-482	6395-278-481	6395-278-482
	STX Hi Gloss	Black	6390-278-491	6390-278-492	6392-278-491	6392-278-492	6395-278-491	6395-278-492
	STX Tactical	Black	6390-278-131	6390-278-132	6392-278-131	6392-278-132	6395-278-131	6395-278-132
Smith & Wesson M&P 9mm, .40, .22LR 4.25" BBL	STX Plain	Black	6390-219-411	6390-219-412	6392-219-411	6392-219-412	6395-219-411	6395-219-412
	STX Basket	Black	6390-219-481	6390-219-482	6392-219-481	6392-219-482	6395-219-481	6395-219-482
	STX Hi Gloss	Black	6390-219-491	6390-219-492	6392-219-491	6392-219-492	6395-219-491	6395-219-492
	STX Tactical	Black	6390-219-131	6390-219-132	6392-219-131	6392-219-132	6395-219-131	6395-219-132
Smith & Wesson M&P 9mm, .40 w/ ITI M3 TLR-1, TLR-1HL SureFire X200/ X300/X300U 4.25" BBL	STX Plain	Black	6390-2192-411	6390-2192-412	6392-2192-411	6392-2192-412	6395-2192-411	6395-2192-412
	STX Basket	Black	6390-2192-481	6390-2192-482	6392-2192-481	6392-2192-482	6395-2192-481	6395-2192-482
	STX Hi Gloss	Black	6390-2192-491	6390-2192-492	6392-2192-491	6392-2192-492	6395-2192-491	6395-2192-492
	STX Tactical	Black	6390-2192-131	6390-2192-132	6392-2192-131	6392-2192-132	6395-2192-131	6395-2192-132
Smith & Wesson M&P 9L 5" BBL	STX Plain	Black	6390-819-411	6390-819-412	6392-819-411	6392-819-412	6395-819-411	6395-819-412
	STX Basket	Black	6390-819-481	6390-819-482	6392-819-481	6392-819-482	6395-819-481	6395-819-482
	STX Hi Gloss	Black	6390-819-491	6390-819-492	6392-819-491	6392-819-492	6395-819-491	6395-819-492
	STX Tactical	Black	6390-819-131	6390-819-132	6392-819-131	6392-819-132	6395-819-131	6395-819-132
Smith & Wesson M&P 45C w/o Manual Thumb Safety 4" BBL	STX Plain	Black	6390-919-411	6390-919-412	6392-919-411	6392-919-412	6395-919-411	6395-919-412
	STX Basket	Black	6390-919-481	6390-919-482	6392-919-481	6392-919-482	6395-919-481	6395-919-482
	STX Hi Gloss	Black	6390-919-491	6390-919-492	6392-919-491	6392-919-492	6395-919-491	6395-919-492
	STX Tactical	Black	6390-919-131	6390-919-132	6392-919-131	6392-919-132	6395-919-131	6395-919-132
Smith & Wesson M&P 45C w/o Manual Thumb Safety w/ ITI M3, TLR-1, TLR-1HL SureFire X200/X300/ X300U 4" BBL	STX Plain	Black	6390-9192-411	6390-9192-412	6392-9192-411	6392-9192-412	6395-9192-411	6395-9192-412
	STX Basket	Black	6390-9192-481	6390-9192-482	6392-9192-481	6392-9192-482	6395-9192-481	6395-9192-482
	STX Hi Gloss	Black	6390-9192-491	6390-9192-492	6392-9192-491	6392-9192-492	6395-9192-491	6395-9192-492
	STX Tactical	Black	6390-9192-131	6390-9192-132	6392-9192-131	6392-9192-132	6395-9192-131	6395-9192-132
Smith & Wesson M&P .45 w/o Manual Thumb Safety 4.5" BBL	STX Plain	Black	6390-419-411	6390-419-412	6392-419-411	6392-419-412	6395-419-411	6395-419-412
	STX Basket	Black	6390-419-481	6390-419-482	6392-419-481	6392-419-482	6395-419-481	6395-419-482
	STX Hi Gloss	Black	6390-419-491	6390-419-492	6392-419-491	6392-419-492	6395-419-491	6395-419-492
	STX Tactical	Black	6390-419-131	6390-419-132	6392-419-131	6392-419-132	6395-419-131	6395-419-132
Smith & Wesson M&P .45 w/o Manual Thumb Safety w/ ITI M3, TLR-1, TLR-1HL SureFire X200/X300/X300U 4.5" BBL	STX Plain	Black	6390-4192-411	6390-4192-412	6392-4192-411	6392-4192-412	6395-4192-411	6395-4192-412
	STX Basket	Black	6390-4192-481	6390-4192-482	6392-4192-481	6392-4192-482	6395-4192-481	6395-4192-482
	STX Hi Gloss	Black	6390-4192-491	6390-4192-492	6392-4192-491	6392-4192-492	6395-4192-491	6395-4192-492
	STX Tactical	Black	6390-4192-131	6390-4192-132	6392-4192-131	6392-4192-132	6395-4192-131	6395-4192-132
Smith & Wesson 5946, 5943 DAO w/o Rails 4" BBL	STX Plain	Black	6390-320-411	6390-320-412	6392-320-411	6392-320-412	6395-320-411	6395-320-412
	STX Basket	Black	6390-320-481	6390-320-482	6392-320-481	6392-320-482	6395-320-481	6395-320-482
	STX Hi Gloss	Black	6390-320-491	6390-320-492	6392-320-491	6392-320-492	6395-320-491	6395-320-492
	STX Tactical	Black	6390-320-131	6390-320-132	6392-320-131	6392-320-132	6395-320-131	6395-320-132
Sphinx SPD-S 4.5" BBL	STX Plain	Black	6390-281-411	6390-281-412	6392-281-411	6392-281-412	6395-281-411	6395-281-412
	STX Basket	Black	6390-281-481	6390-281-482	6392-281-481	6392-281-482	6395-281-481	6395-281-482
	STX Hi Gloss	Black	6390-281-491	6390-281-492	6392-281-491	6392-281-492	6395-281-491	6395-281-492
	STX Tactical	Black	6390-281-131	6390-281-132	6392-281-131	6392-281-132	6395-281-131	6395-281-132
Springfield Armory XD(M) 9mm 4.5" BBL	STX Plain	Black	6390-145-411	6390-145-412	6392-145-411	6392-145-412	6395-145-411	6395-145-412
	STX Basket	Black	6390-145-481	6390-145-482	6392-145-481	6392-145-482	6395-145-481	6395-145-482
	STX Hi Gloss	Black	6390-145-491	6390-145-492	6392-145-491	6392-145-492	6395-145-491	6395-145-492
	STX Tactical	Black	6390-145-131	6390-145-132	6392-145-131	6392-145-132	6395-145-131	6395-145-132



Duty Holsters

6390/6392/6395 ALS® LEVEL I RETENTION™ HOLSTERS FOR: PISTOLS (continued)

How to Order
Duty Holsters
Duty Accessories
Tactical Holsters
Tactical Accessories
Duty Belts
QAS
Speed Loaders
Light Systems
Concealment Holsters
Concealment Accessories
Competition
Apparel
Sales Support
Index/Price List

GUN DESCRIPTION	FINISH	COLOR	6390 MID-RIDE		6392 HI-RIDE		6395 LOW-RIDE	
			RIGHT	LEFT	RIGHT	LEFT	RIGHT	LEFT
Springfield Armory XD(M) .40 4.5" BBL	STX Plain	Black	6390-146-411	6390-146-412	6392-146-411	6392-146-412	6395-146-411	6395-146-412
	STX Basket	Black	6390-146-481	6390-146-482	6392-146-481	6392-146-482	6395-146-481	6395-146-482
	STX Hi Gloss	Black	6390-146-491	6390-146-492	6392-146-491	6392-146-492	6395-146-491	6395-146-492
	STX Tactical	Black	6390-146-131	6390-146-132	6392-146-131	6392-146-132	6395-146-131	6395-146-132
Springfield Armory XD(M) 9mm w/ ITI M3, TLR-1, TLR-1HL SureFire X200/X300/ X300U 4.5" BBL	STX Plain	Black	6390-1452-411	6390-1452-412	6392-1452-411	6392-1452-412	6395-1452-411	6395-1452-412
	STX Basket	Black	6390-1452-481	6390-1452-482	6392-1452-481	6392-1452-482	6395-1452-481	6395-1452-482
	STX Hi Gloss	Black	6390-1452-491	6390-1452-492	6392-1452-491	6392-1452-492	6395-1452-491	6395-1452-492
	STX Tactical	Black	6390-1452-131	6390-1452-132	6392-1452-131	6392-1452-132	6395-1452-131	6395-1452-132
Springfield Armory XD(M) .40 w/ ITI M3, TLR-1, TLR-1HL SureFire X200/X300/X300U 4.5" BBL	STX Plain	Black	6390-1462-411	6390-1462-412	6392-1462-411	6392-1462-412	6395-1462-411	6395-1462-412
	STX Basket	Black	6390-1462-481	6390-1462-482	6392-1462-481	6392-1462-482	6395-1462-481	6395-1462-482
	STX Hi Gloss	Black	6390-1462-491	6390-1462-492	6392-1462-491	6392-1462-492	6395-1462-491	6395-1462-492
	STX Tactical	Black	6390-1462-131	6390-1462-132	6392-1462-131	6392-1462-132	6395-1462-131	6395-1462-132
Springfield Armory 1911-A1 w/Picatinny Light Rail 5" BBL	STX Plain	Black	6390-56-411	6390-56-412		6392-56-412		6395-56-412
	STX Basket	Black	6390-56-481	6390-56-482	6392-56-481	6392-56-482	6395-56-481	6395-56-482
	STX Hi Gloss	Black	6390-56-491	6390-56-492	6392-56-491	6392-56-492	6395-56-491	6395-56-492
	STX Tactical	Black	6390-56-131	6390-56-132	6392-56-131	6392-56-132	6395-56-131	6395-56-132
Springfield Armory Operator 1911-A1 w/Picatinny Light Rail w/ SureFire X200/X300/X300U 5" BBL	STX Plain	Black	6390-560-411	6390-560-412	6390-560-411	6392-560-412	6390-560-411	6395-560-412
	STX Basket	Black	6390-560-481	6390-560-482	6392-560-481	6392-560-482	6395-560-481	6395-560-482
	STX Hi Gloss	Black	6390-560-491	6390-560-492	6392-560-491	6392-560-492	6395-560-491	6395-560-492
	STX Tactical	Black	6390-560-131	6390-560-132	6392-560-131	6392-560-132	6395-560-131	6395-560-132
Taurus PT840, PT809 4" BBL	STX Plain	Black	6390-268-411	6390-268-412	6392-268-411	6392-268-412	6395-268-411	6395-268-412
	STX Basket	Black	6390-268-481	6390-268-482	6392-268-481	6392-268-482	6395-268-481	6395-268-482
	STX Hi Gloss	Black	6390-268-491	6390-268-492	6392-268-491	6392-268-492	6395-268-491	6395-268-492
	STX Tactical	Black	6390-268-131	6390-268-132	6392-268-131	6392-268-132	6395-268-131	6395-268-132

6006 ALS Guard	Black	6006-1-21	6006-1-22
6007 ALS Hood Guard	Black	6007-21	6007-22
6008 Hood Guard & ALS Guard	Black	6008-21	6008-22

Duty Holsters



6390/6392/6395 RDS ALS® LEVEL I RETENTION™ HOLSTERS FOR: PISTOLS



PATENTED

6390 MID-RIDE



PATENTED

6392 HI-RIDE



PATENTED

6395 LOW-RIDE

FEATURES

- ▶ ALS® (Automatic Locking Systems) secures weapon once holstered; simple straight up draw once release is deactivated
- ▶ For use with red dot optic-equipped weapons
- ▶ SafariLaminate™ thermal-molded construction protects handgun and sights
- ▶ Suede lined to protect handgun's finish
- ▶ Available in Cordura® Nylon, MultiCam®, Ranger Green, Coyote, Khaki, or Black finishes.
- ▶ Optic Hood Cover (optional)

GUN DESCRIPTION	FINISH*	COLOR	6390RDS MID-RIDE		6392RDS HI-RIDE		6395RDS LOW-RIDE	
			RIGHT	LEFT	RIGHT	LEFT	RIGHT	LEFT
Glock 17/22 w/ITI M3 Light, TLR-1, TLR-1HL, SureFire X200/X300/X300U 4.5" BBL	Cordura®	MultiCam®	6390RDS-832-701	6390RDS-832-702	6392RDS-832-701	6392RDS-832-702	6395RDS-832-701	6395RDS-832-702
	Cordura®	Ranger Green	6390RDS-832-731	6390RDS-832-732	6392RDS-832-731	6392RDS-832-732	6395RDS-832-731	6395RDS-832-732
	Cordura®	Coyote	6390RDS-832-741	6390RDS-832-742	6392RDS-832-741	6392RDS-832-742	6395RDS-832-741	6395RDS-832-742
	Cordura®	Khaki	6390RDS-832-751	6390RDS-832-752	6392RDS-832-751	6392RDS-832-752	6395RDS-832-751	6395RDS-832-752
	Cordura®	Black	6390RDS-832-781	6390RDS-832-782	6392RDS-832-781	6392RDS-832-782	6395RDS-832-781	6395RDS-832-782
	Tactical	Black	6390RDS-832-131	6390RDS-832-132	6392RDS-832-131	6392RDS-832-132	6395RDS-832-131	6395RDS-832-132
Glock 19/23 w/ITI M3 Light, TLR-1, TLR-1HL, SureFire X200/X300/X300U 4" BBL	Cordura®	MultiCam®	6390RDS-2832-701	6390RDS-2832-702	6392RDS-2832-701	6392RDS-2832-702	6395RDS-2832-701	6395RDS-2832-702
	Cordura®	Ranger Green	6390RDS-2832-731	6390RDS-2832-732	6392RDS-2832-731	6392RDS-2832-732	6395RDS-2832-731	6395RDS-2832-732
	Cordura®	Coyote	6390RDS-2832-741	6390RDS-2832-742	6392RDS-2832-741	6392RDS-2832-742	6395RDS-2832-741	6395RDS-2832-742
	Cordura®	Khaki	6390RDS-2832-751	6390RDS-2832-752	6392RDS-2832-751	6392RDS-2832-752	6395RDS-2832-751	6395RDS-2832-752
	Cordura®	Black	6390RDS-2832-781	6390RDS-2832-782	6392RDS-2832-781	6392RDS-2832-782	6395RDS-2832-781	6395RDS-2832-782
	Tactical	Black	6390RDS-2832-131	6390RDS-2832-132	6392RDS-2832-131	6392RDS-2832-132	6395RDS-2832-131	6395RDS-2832-132
Glock 34/35 w/ITI M3 Light, TLR-1, TLR-1HL, SureFire X200/X300/X300U 5.32" BBL	Cordura®	MultiCam®	6390RDS-6832-701	6390RDS-6832-702	6392RDS-6832-701	6392RDS-6832-702	6395RDS-6832-701	6395RDS-6832-702
	Cordura®	Ranger Green	6390RDS-6832-731	6390RDS-6832-732	6392RDS-6832-731	6392RDS-6832-732	6395RDS-6832-731	6395RDS-6832-732
	Cordura®	Coyote	6390RDS-6832-741	6390RDS-6832-742	6392RDS-6832-741	6392RDS-6832-742	6395RDS-6832-741	6395RDS-6832-742
	Cordura®	Khaki	6390RDS-6832-751	6390RDS-6832-752	6392RDS-6832-751	6392RDS-6832-752	6395RDS-6832-751	6395RDS-6832-752
	Cordura®	Black	6390RDS-6832-781	6390RDS-6832-782	6392RDS-6832-781	6392RDS-6832-782	6395RDS-6832-781	6395RDS-6832-782
	Tactical	Black	6390RDS-6832-131	6390RDS-6832-132	6392RDS-6832-131	6392RDS-6832-132	6395RDS-6832-131	6395RDS-6832-132
Smith & Wesson M&P 9mm, .40 w/ITI M3 Light, TLR-1, TLR-1HL, SureFire X200/X300/X300U 4.25" BBL	Cordura®	MultiCam®	6390RDS-2192-701	6390RDS-2192-702	6392RDS-2192-701	6392RDS-2192-702	6395RDS-2192-701	6395RDS-2192-702
	Cordura®	Ranger Green	6390RDS-2192-731	6390RDS-2192-732	6392RDS-2192-731	6392RDS-2192-732	6395RDS-2192-731	6395RDS-2192-732
	Cordura®	Coyote	6390RDS-2192-741	6390RDS-2192-742	6392RDS-2192-741	6392RDS-2192-742	6395RDS-2192-741	6395RDS-2192-742
	Cordura®	Khaki	6390RDS-2192-751	6390RDS-2192-752	6392RDS-2192-751	6392RDS-2192-752	6395RDS-2192-751	6395RDS-2192-752
	Cordura®	Black	6390RDS-2192-781	6390RDS-2192-782	6392RDS-2192-781	6392RDS-2192-782	6395RDS-2192-781	6395RDS-2192-782
	Tactical	Black	6390RDS-2192-131	6390RDS-2192-132	6392RDS-2192-131	6392RDS-2192-132	6395RDS-2192-131	6395RDS-2192-132
Smith & Wesson M&P C.O.R.E w/ITI M3 Light, TLR-1, TLR-1HL, SureFire X200/X300/X300U 5" BBL	Cordura®	MultiCam®	6390RDS-8192-701	6390RDS-8192-702	6392RDS-8192-701	6392RDS-8192-702	6395RDS-8192-701	6395RDS-8192-702
	Cordura®	Ranger Green	6390RDS-8192-731	6390RDS-8192-732	6392RDS-8192-731	6392RDS-8192-732	6395RDS-8192-731	6395RDS-8192-732
	Cordura®	Coyote	6390RDS-8192-741	6390RDS-8192-742	6392RDS-8192-741	6392RDS-8192-742	6395RDS-8192-741	6395RDS-8192-742
	Cordura®	Khaki	6390RDS-8192-751	6390RDS-8192-752	6392RDS-8192-751	6392RDS-8192-752	6395RDS-8192-751	6395RDS-8192-752
	Cordura®	Black	6390RDS-8192-781	6390RDS-8192-782	6392RDS-8192-781	6392RDS-8192-782	6395RDS-8192-781	6395RDS-8192-782
	Tactical	Black	6390RDS-8192-131	6390RDS-8192-132	6392RDS-8192-131	6392RDS-8192-132	6395RDS-8192-131	6395RDS-8192-132



Duty Holsters

6360/6362/6365 ALS®/SLS LEVEL III RETENTION™ HOLSTERS FOR: PISTOLS



PATENTED

6360 MID-RIDE



PATENTED

6362 HI-RIDE



PATENTED

6365 LOW-RIDE

FEATURES

- ▶ Level III Retention™ holster
- ▶ Level IV Retention™ with optional Sentry installed
- ▶ ALS® (Automatic Locking System) secures weapon once holstered
- ▶ Hood Guard is standard
- ▶ SLS (Self Locking System) Rotating Hood
- ▶ Slim, compact design allows weapon to ride close to body
- ▶ Simple straight up draw once all releases are deactivated
- ▶ Fits available for light mounted weapons
- ▶ Offered in 2" (50mm) or 2.25" (58mm) belt slots only
- ▶ Available in Plain Black, Basketweave, Hi Gloss, Nylon Look, STX Tactical® (all colors) and STX finishes
- ▶ Safariland offers training DVDs for various products. For more information on retention levels and this product please review TV-1012D, TV-1007D and TV-1015D

*Available in these additional STX finishes:
 Use Sample Code 6360-83-41I
 STX Plain 6360-XX-41X
 STX Basket 6360-XX-48X
 STX Hi Gloss 6360-XX-49X

Models 6360/6362/6365 Duty Holsters include Installed Hood Guard
 Sample Code with Sentry Only Installed:
 6360-83-61-S
 Sample Code with Hood Guard & Sentry Installed:
 6360-83-61-SH

6000

6001

6002

Safariland offers three uniquely designed accessories for the SLS holster system, the 6000 hood Guard, the 6001 Sentry (converting the holster to a higher level of security) and the 6002 hood guard/Sentry combination. Available for SLS models including 6004, 6005, 6034, 6035, 6230, 6235, 6280, 6282, 6287, 7004, 7005, 7280, 7282, 7285, and the 7287. ALS Series SLS holsters including the 6360, 6362, 6365, 6304, 6305, 6354, 6355, 6367, 7304, 7305, 7360, 7362, 7365 and the 7367.

How to Order
Duty Holsters
Duty Accessories
Tactical Holsters
Tactical Accessories
Duty Belts
OAS
Speed Loaders
Light Systems
Concealment Holsters
Concealment Accessories
Competition
Apparel
Sales Support
Index/Price List



Duty Holsters

6360/6362/6365 ALS®/SLS LEVEL III RETENTION™ HOLSTERS FOR: PISTOLS

How to Order
Duty Holsters
Duty Accessories
Tactical Holsters
Tactical Accessories
Duty Belts
OAS
Speed Loaders
Light Systems
Concealment Holsters
Concealment Accessories
Competition
Apparel
Sales Support
Index/ Price List

GUN DESCRIPTION	FINISH*	COLOR	6360 MID-RIDE		6362 HI-RIDE		6365 LOW-RIDE	
			RIGHT	LEFT	RIGHT	LEFT	RIGHT	LEFT
Beretta APX 9mm, .40 S&W 4.25" BBL	Plain	Black	6360-148-61	6360-148-62	6362-148-61	6362-148-62	6365-148-61	6365-148-62
	Basket	Black	6360-148-81	6360-148-82	6362-148-81	6362-148-82	6365-148-81	6365-148-82
	Hi Gloss	Black	6360-148-91	6360-148-92	6362-148-91	6362-148-92	6365-148-91	6365-148-92
	STX Tactical	Black	6360-148-131	6360-148-132	6362-148-131	6362-148-132	6365-148-131	6365-148-132
Beretta Px4 Storm, 9mm, .40 4" BBL	Plain	Black	6360-180-61	6360-180-62	6362-180-61	6362-180-62	6365-180-61	6365-180-62
	Basket	Black	6360-180-81	6360-180-82	6362-180-81	6362-180-82	6365-180-81	6365-180-82
	Hi Gloss	Black	6360-180-91	6360-180-92	6362-180-91	6362-180-92	6365-180-91	6365-180-92
	STX Tactical	Black	6360-180-131	6360-180-132	6362-180-131	6362-180-132	6365-180-131	6365-180-132
Beretta Px4 Storm .45ACP 4.1" BBL	Plain	Black	6360-185-61	6360-185-62	6362-185-61	6362-185-62	6365-185-61	6365-185-62
	Basket	Black	6360-185-81	6360-185-82	6362-185-81	6362-185-82	6365-185-81	6365-185-82
	Hi Gloss	Black	6360-185-91	6360-185-92	6362-185-91	6362-185-92	6365-185-91	6365-185-92
	STX Tactical	Black	6360-185-131	6360-185-132	6362-185-131	6362-185-132	6365-185-131	6365-185-132
Beretta 92F, 92FS, 92G, 96, 96G 4.9" BBL	Plain	Black	6360-73-61	6360-73-62	6362-73-61	6362-73-62	6365-73-61	6365-73-62
	Basket	Black	6360-73-81	6360-73-82	6362-73-81	6362-73-82	6365-73-81	6365-73-82
	Hi Gloss	Black	6360-73-91	6360-73-92	6362-73-91	6362-73-92	6365-73-91	6365-73-92
	STX Tactical	Black	6360-73-131	6360-73-132	6362-73-131	6362-73-132	6365-73-131	6365-73-132
Colt Government 1911 5" BBL	Plain	Black	6360-53-61	6360-53-62	6362-53-61	6362-53-62	6365-53-61	6365-53-62
	Basket	Black	6360-53-81	6360-53-82	6362-53-81	6362-53-82	6365-53-81	6365-53-82
	Hi Gloss	Black	6360-53-91	6360-53-92	6362-53-91	6362-53-92	6365-53-91	6365-53-92
	STX Tactical	Black	6360-53-131	6360-53-132	6362-53-131	6362-53-132	6365-53-131	6365-53-132
CZ P-07 3.8" BBL	Plain	Black	6360-292-61	6360-292-62	6362-292-61	6362-292-62	6365-292-61	6365-292-62
	Basket	Black	6360-292-81	6360-292-82	6362-292-81	6362-292-82	6365-292-81	6365-292-82
	Hi Gloss	Black	6360-292-91	6360-292-92	6362-292-91	6362-292-92	6365-292-91	6365-292-92
	STX Tactical	Black	6360-292-131	6360-292-132	6362-292-131	6362-292-132	6365-292-131	6365-292-132
FN FNS .40 4" BBL	Plain	Black	6360-266-61	6360-266-62	6362-266-61	6362-266-62	6365-266-61	6365-266-62
	Basket	Black	6360-266-81	6360-266-82	6362-266-81	6362-266-82	6365-266-81	6365-266-82
	Hi Gloss	Black	6360-266-91	6360-266-92	6362-266-91	6362-266-92	6365-266-91	6365-266-92
	STX Tactical	Black	6360-266-131	6360-266-132	6362-266-131	6362-266-132	6365-266-131	6365-266-132
Glock ¹ 17, 22 4.5" BBL	Plain	Black	6360-83-61	6360-83-62	6362-83-61	6362-83-62	6365-83-61	6365-83-62
	Basket	Black	6360-83-81	6360-83-82	6362-83-81	6362-83-82	6365-83-81	6365-83-82
	Hi Gloss	Black	6360-83-91	6360-83-92	6362-83-91	6362-83-92	6365-83-91	6365-83-92
	STX Tactical	Black	6360-83-131 ¹	6360-83-132 ¹	6362-83-131 ¹	6362-83-132 ¹	6365-83-131 ¹	6365-83-132 ¹
Glock 17, 22 w/ Dual Magazine Release 4.50" BBL	Plain	Black	6360-983-61	6360-983-62	6362-983-61	6362-983-62	6365-983-61	6365-983-62
	Basket	Black	6360-983-81	6360-983-82	6362-983-81	6362-983-82	6365-983-81	6365-983-82
	Hi Gloss	Black	6360-983-91	6360-983-92	6362-983-91	6362-983-92	6365-983-91	6365-983-92
	STX Tactical	Black	6360-983-131	6360-983-132	6362-983-131	6362-983-132	6365-983-131	6365-983-132
Glock 17, 22 w/ ITI M3 Light, TLR-1, TLR-1HL SureFire X200/X300/X300U 4.5" BBL	Plain	Black	6360-832-61	6360-832-62	6362-832-61	6362-832-62	6365-832-61	6365-832-62
	Basket	Black	6360-832-81	6360-832-82	6362-832-81	6362-832-82	6365-832-81	6365-832-82
	Hi Gloss	Black	6360-832-91	6360-832-92	6362-832-91	6362-832-92	6365-832-91	6365-832-92
	STX Tactical	Black	6360-832-131	6360-832-132	6362-832-131	6362-832-132	6365-832-131	6365-832-132
Glock 17, 22 w/ ITI M3X or TLR-1 4.5" BBL	Plain	Black	6360-8311-61	6360-8311-62	6362-8311-61	6362-8311-62	6365-8311-61	6365-8311-62
	Basket	Black	6360-8311-81	6360-8311-82	6362-8311-81	6362-8311-82	6365-8311-81	6365-8311-82
	Hi Gloss	Black	6360-8311-91	6360-8311-92	6362-8311-91	6362-8311-92	6365-8311-91	6365-8311-92
	STX Tactical	Black	6360-8311-131	6360-8311-132	6362-8311-131	6362-8311-132	6365-8311-131	6365-8311-132
Glock 17, 22, w/ GTL 10 Light Only GTL 21/22 Light/Laser Combination GTL 51/52 Light/Laser Combination, 4.5" BBL	Plain	Black	6360-8310-61	6360-8310-62	6362-8310-61	6362-8310-62	6365-8310-61	6365-8310-62
	Basket	Black	6360-8310-81	6360-8310-82	6362-8310-81	6362-8310-82	6365-8310-81	6365-8310-82
	Hi Gloss	Black	6360-8310-91	6360-8310-92	6362-8310-91	6362-8310-92	6365-8310-91	6365-8310-92
	STX Tactical	Black	6360-8310-131	6360-8310-132	6362-8310-131	6362-8310-132	6365-8310-131	6365-8310-132
Glock 19, 23 4" BBL 26, 27 3.5" BBL	Plain	Black	6360-283-61	6360-283-62	6362-283-61	6362-283-62	6365-283-61	6365-283-62
	Basket	Black	6360-283-81	6360-283-82	6362-283-81	6362-283-82	6365-283-81	6365-283-82
	Hi Gloss	Black	6360-283-91	6360-283-92	6362-283-91	6362-283-92	6365-283-91	6365-283-92
	STX Tactical	Black	6360-283-131	6360-283-132	6362-283-131	6362-283-132	6365-283-131	6365-283-132
Glock 19, 23 w/ ITI M3, TLR-1, TLR-1HL SureFire X200/X300/X300U 4" BBL	Plain	Black	6360-2832-61	6360-2832-62	6362-2832-61	6362-2832-62	6365-2832-61	6365-2832-62
	Basket	Black	6360-2832-81	6360-2832-82	6362-2832-81	6362-2832-82	6365-2832-81	6365-2832-82
	Hi Gloss	Black	6360-2832-91	6360-2832-92	6362-2832-91	6362-2832-92	6365-2832-91	6365-2832-92
	STX Tactical	Black	6360-2832-131	6360-2832-132	6362-2832-131	6362-2832-132	6365-2832-131	6365-2832-132
Glock 20, 21 4.6" BBL	Plain	Black	6360-383-61	6360-383-62	6362-383-61	6362-383-62	6365-383-61	6365-383-62
	Basket	Black	6360-383-81	6360-383-82	6362-383-81	6362-383-82	6365-383-81	6365-383-82
	Hi Gloss	Black	6360-383-91	6360-383-92	6362-383-91	6362-383-92	6365-383-91	6365-383-92
	STX Tactical	Black	6360-383-131	6360-383-132	6362-383-131	6362-383-132	6365-383-131	6365-383-132
Glock 20, 21 w/ ITI M3, TLR-1, TLR-1HL SureFire X200/X300/X300U 4.6" BBL	Plain	Black	6360-3832-61	6360-3832-62	6362-3832-61	6362-3832-62	6365-3832-61	6365-3832-62
	Basket	Black	6360-3832-81	6360-3832-82	6362-3832-81	6362-3832-82	6365-3832-81	6365-3832-82
	Hi Gloss	Black	6360-3832-91	6360-3832-92	6362-3832-91	6362-3832-92	6365-3832-91	6365-3832-92
	STX Tactical	Black	6360-3832-131	6360-3832-132	6362-3832-131	6362-3832-132	6365-3832-131	6365-3832-132
Glock 29, 30 3.78" BBL	Plain	Black	6360-483-61	6360-483-62	6362-483-61	6362-483-62	6365-483-61	6365-483-62
	Basket	Black	6360-483-81	6360-483-82	6362-483-81	6362-483-82	6365-483-81	6365-483-82
	Hi Gloss	Black	6360-483-91	6360-483-92	6362-483-91	6362-483-92	6365-483-91	6365-483-92
	STX Tactical	Black	6360-483-131	6360-483-132	6362-483-131	6362-483-132	6365-483-131	6365-483-132



Duty Holsters

6360/6362/6365 ALS®/SLS LEVEL III RETENTION™ HOLSTERS FOR: PISTOLS (continued)

GUN DESCRIPTION	FINISH*	COLOR	6360 MID-RIDE		6362 HI-RIDE		6365 LOW-RIDE	
			RIGHT	LEFT	RIGHT	LEFT	RIGHT	LEFT
Glock 30S 3.77" BBL	Plain	Black	6360-485-61	6360-485-62	6362-485-61	6362-485-62	6365-485-61	6365-485-62
	Basket	Black	6360-485-81	6360-485-82	6362-485-81	6362-485-82	6365-485-81	6365-485-82
	Hi Gloss	Black	6360-485-91	6360-485-92	6362-485-91	6362-485-92	6365-485-91	6365-485-92
	STX Tactical	Black	6360-485-131	6360-485-132	6362-485-131	6362-485-132	6365-485-131	6365-485-132
Glock 34, 35 5.32" BBL	Plain	Black	6360-683-61	6360-683-62	6362-683-61	6362-683-62	6365-683-61	6365-683-62
	Basket	Black	6360-683-81	6360-683-82	6362-683-81	6362-683-82	6365-683-81	6365-683-82
	Hi Gloss	Black	6360-683-91	6360-683-92	6362-683-91	6362-683-92	6365-683-91	6365-683-92
	STX Tactical	Black	6360-683-131	6360-683-132	6362-683-131	6362-683-132	6365-683-131	6365-683-132
Glock 34, 35 w/ ITI M3, TLR-1, TLR-1HL SureFire X200/X300/X300U 5.32" BBL	Plain	Black	6360-6832-61	6360-6832-62	6362-6832-61	6362-6832-62	6365-6832-61	6365-6832-62
	Basket	Black	6360-6832-81	6360-6832-82	6362-6832-81	6362-6832-82	6365-6832-81	6365-6832-82
	Hi Gloss	Black	6360-6832-91	6360-6832-92	6362-6832-91	6362-6832-92	6365-6832-91	6365-6832-92
	STX Tactical	Black	6360-6832-131	6360-6832-132	6362-6832-131	6362-6832-132	6365-6832-131	6365-6832-132
Glock 37 4.5" BBL	Plain	Black	6360-783-61	6360-783-62	6362-783-61	6362-783-62	6365-783-61	6365-783-62
	Basket	Black	6360-783-81	6360-783-82	6362-783-81	6362-783-82	6365-783-81	6365-783-82
	Hi Gloss	Black	6360-783-91	6360-783-92	6362-783-91	6362-783-92	6365-783-91	6365-783-92
	STX Tactical	Black	6360-783-131	6360-783-132	6362-783-131	6362-783-132	6365-783-131	6365-783-132
Glock 37 w/ ITI M3, TLR-1, TLR-1HL SureFire X200/X300/X300U 4.5" BBL	Plain	Black	6360-7832-61	6360-7832-62	6362-7832-61	6362-7832-62	6365-7832-61	6365-7832-62
	Basket	Black	6360-7832-81	6360-7832-82	6362-7832-81	6362-7832-82	6365-7832-81	6365-7832-82
	Hi Gloss	Black	6360-7832-91	6360-7832-92	6362-7832-91	6362-7832-92	6365-7832-91	6365-7832-92
	STX Tactical	Black	6360-7832-131	6360-7832-132	6362-7832-131	6362-7832-132	6365-7832-131	6365-7832-132
Glock 41 5.31" BBL	Plain	Black	6360-893-61	6360-893-62	6362-893-61	6362-893-62	6365-893-61	6365-893-62
	Basket	Black	6360-893-81	6360-893-82	6362-893-81	6362-893-82	6365-893-81	6365-893-82
	Hi Gloss	Black	6360-893-91	6360-893-92	6362-893-91	6362-893-92	6365-893-91	6365-893-92
	STX Tactical	Black	6360-893-131	6360-893-132	6362-893-131	6362-893-132	6365-893-131	6365-893-132
Glock 41 w/ ITI M3, TLR-1, TLR-1HL SureFire X200/X300/X300U 5.31" BBL	Plain	Black	6360-8932-61	6360-8932-62	6362-8932-61	6362-8932-62	6365-8932-61	6365-8932-62
	Basket	Black	6360-8932-81	6360-8932-82	6362-8932-81	6362-8932-82	6365-8932-81	6365-8932-82
	Hi Gloss	Black	6360-8932-91	6360-8932-92	6362-8932-91	6362-8932-92	6365-8932-91	6365-8932-92
	STX Tactical	Black	6360-8932-131	6360-8932-132	6362-8932-131	6362-8932-132	6365-8932-131	6365-8932-132
Heckler & Koch P30 3.875" BBL	Plain	Black	6360-295-61	6360-295-62	6362-295-61	6362-295-62	6365-295-61	6365-295-62
	Basket	Black	6360-295-81	6360-295-82	6362-295-81	6362-295-82	6365-295-81	6365-295-82
	Hi Gloss	Black	6360-295-91	6360-295-92	6362-295-91	6362-295-92	6365-295-91	6365-295-92
	STX Tactical	Black	6360-295-131	6360-295-132	6362-295-131	6362-295-132	6365-295-131	6365-295-132
Heckler & Koch P30 w/ ITI M3, TLR-1, TLR-1HL SureFire X200/X300/X300U 3.78" BBL	Plain	Black	6360-2952-61	6360-2952-62	6362-2952-61	6362-2952-62	6365-2952-61	6365-2952-62
	Basket	Black	6360-2952-81	6360-2952-82	6362-2952-81	6362-2952-82	6365-2952-81	6365-2952-82
	Hi Gloss	Black	6360-2952-91	6360-2952-92	6362-2952-91	6362-2952-92	6365-2952-91	6365-2952-92
	STX Tactical	Black	6360-2952-131	6360-2952-132	6362-2952-131	6362-2952-132	6365-2952-131	6365-2952-132
Heckler & Koch P30L w/ ITI M3, TLR-1, TLR-1HL SureFire X200/X300/X300U 4.45" BBL	Plain	Black	6360-3952-61	6360-3952-62	6362-3952-61	6362-3952-62	6365-3952-61	6365-3952-62
	Basket	Black	6360-3952-81	6360-3952-82	6362-3952-81	6362-3952-82	6365-3952-81	6365-3952-82
	Hi Gloss	Black	6360-3952-91	6360-3952-92	6362-3952-91	6362-3952-92	6365-3952-91	6365-3952-92
	STX Tactical	Black	6360-3952-131	6360-3952-132	6362-3952-131	6362-3952-132	6365-3952-131	6365-3952-132
Heckler & Koch USP 9/40 w/ TRL-3 4.25" BBL	Plain	Black	6360-29116-61	6360-29116-62	6362-29116-61	6362-29116-62	6365-29116-61	6365-29116-62
	Basket	Black	6360-29116-81	6360-29116-82	6362-29116-81	6362-29116-82	6365-29116-81	6365-29116-82
	Hi Gloss	Black	6360-29116-91	6360-29116-92	6362-29116-91	6362-29116-92	6365-29116-91	6365-29116-92
	STX Tactical	Black	6360-29116-131	6360-29116-132	6362-29116-131	6362-29116-132	6365-29116-131	6365-29116-132
Heckler & Koch USP 9C 4.25" BBL	Plain	Black	6360-291-61	6360-291-62	6362-291-61	6362-291-62	6365-291-61	6365-291-62
	Basket	Black	6360-291-81	6360-291-82	6362-291-81	6362-291-82	6365-291-81	6365-291-82
	Hi Gloss	Black	6360-291-91	6360-291-92	6362-291-91	6362-291-92	6365-291-91	6365-291-92
	STX Tactical	Black	6360-291-131	6360-291-132	6362-291-131	6362-291-132	6365-291-131	6365-291-132
Heckler & Koch USP 9mm, .40 4.13" BBL	Plain	Black	6360-91-61	6360-91-62	6362-91-61	6362-91-62	6365-91-61	6365-91-62
	Basket	Black	6360-91-81	6360-91-82	6362-91-81	6362-91-82	6365-91-81	6365-91-82
	Hi Gloss	Black	6360-91-91	6360-91-92	6362-91-91	6362-91-92	6365-91-91	6365-91-92
	STX Tactical	Black	6360-91-131	6360-91-132	6362-91-131	6362-91-132	6365-91-131	6365-91-132
Heckler & Koch P2000 3.5" BBL	Plain	Black	6360-97-61	6360-97-62	6362-97-61	6362-97-62	6365-97-61	6365-97-62
	Basket	Black	6360-97-81	6360-97-82	6362-97-81	6362-97-82	6365-97-81	6365-97-82
	Hi Gloss	Black	6360-97-91	6360-97-92	6362-97-91	6362-97-92	6365-97-91	6365-97-92
	STX Tactical	Black	6360-97-131	6360-97-132	6362-97-131	6362-97-132	6365-97-131	6365-97-132
Heckler & Koch P2000 US Version w/ ITI M3, TLR-1, TLR-1HL SureFire X200/X300/X300U 3.5" BBL	Plain	Black	6360-1972-61	6360-1972-62	6362-1972-61	6362-1972-62	6365-1972-61	6365-1972-62
	Basket	Black	6360-1972-81	6360-1972-82	6362-1972-81	6362-1972-82	6365-1972-81	6365-1972-82
	Hi Gloss	Black	6360-1972-91	6360-1972-92	6362-1972-91	6362-1972-92	6365-1972-91	6365-1972-92
	STX Tactical	Black	6360-1972-131	6360-1972-132	6362-1972-131	6362-1972-132	6365-1972-131	6365-1972-132
Heckler & Koch VP9 4.09" BBL	Plain	Black	6360-593-61	6360-593-62	6362-593-61	6362-593-62	6365-593-61	6365-593-62
	Basket	Black	6360-593-81	6360-593-82	6362-593-81	6362-593-82	6365-593-81	6365-593-82
	Hi Gloss	Black	6360-593-91	6360-593-92	6362-593-91	6362-593-92	6365-593-91	6365-593-92
	STX Tactical	Black	6360-593-131	6360-593-132	6362-593-131	6362-593-132	6365-593-131	6365-593-132
Heckler & Koch VP9 w/ ITI M3, TLR-1, TLR-1HL SureFire X200/X300/X300U 4.09" BBL	Plain	Black	6360-5932-61	6360-5932-62	6362-5932-61	6362-5932-62	6365-5932-61	6365-5932-62
	Basket	Black	6360-5932-81	6360-5932-82	6362-5932-81	6362-5932-82	6365-5932-81	6365-5932-82
	Hi Gloss	Black	6360-5932-91	6360-5932-92	6362-5932-91	6362-5932-92	6365-5932-91	6365-5932-92
	STX Tactical	Black	6360-5932-131	6360-5932-132	6362-5932-131	6362-5932-132	6365-5932-131	6365-5932-132
Sig Sauer P220, P226 4.41" BBL	Plain	Black	6360-77-61	6360-77-62	6362-77-61	6362-77-62	6365-77-61	6365-77-62
	Basket	Black	6360-77-81	6360-77-82	6362-77-81	6362-77-82	6365-77-81	6365-77-82
	Hi Gloss	Black	6360-77-91	6360-77-92	6362-77-91	6362-77-92	6365-77-91	6365-77-92
	STX Tactical	Black	6360-77-131	6360-77-132	6362-77-131	6362-77-132	6365-77-131	6365-77-132

How to Order
Duty Holsters
Duty Accessories
Tactical Holsters
Tactical Accessories
Duty Belts
QAS
Speed Loaders
Light Systems
Concealment Holsters
Concealment Accessories
Competition
Apparel
Sales Support
Index/Price List



Duty Holsters

6360/6362/6365 ALS®/SLS LEVEL III RETENTION™ HOLSTERS FOR: PISTOLS

How to Order
Duty Holsters
Duty Accessories
Tactical Holsters
Tactical Accessories
Duty Belts
OAS
Speed Loaders
Light Systems
Concealment Holsters
Concealment Accessories
Competition
Apparel
Sales Support
Index/Price List

GUN DESCRIPTION	FINISH*	COLOR	6360 MID-RIDE		6362 HI-RIDE		6365 LOW-RIDE	
			RIGHT	LEFT	RIGHT	LEFT	RIGHT	LEFT
Sig Sauer P220R DAK, P226R DAK w/ Bobbed Hammer; P220R DA/SA, P226R DA/SA w/ Full Size Hammer 4.41" BBL	Plain	Black	6360-477-61	6360-477-62	6362-477-61	6362-477-62	6365-477-61	6365-477-62
	Basket	Black	6360-477-81	6360-477-82	6362-477-81	6362-477-82	6365-477-81	6365-477-82
	Hi Gloss	Black	6360-477-91	6360-477-92	6362-477-91	6362-477-92	6365-477-91	6365-477-92
	STX Tactical	Black	6360-477-131	6360-477-132	6362-477-131	6362-477-132	6365-477-131	6365-477-132
Sig Sauer P220R, P226R w/ ITI M3 w/ Accessory Rails TLR-1, TLR-1HL SureFire X200/X300/X300U 4.41" BBL	Plain	Black	6360-7742-61	6360-7742-62	6362-7742-61	6362-7742-62	6365-7742-61	6365-7742-62
	Basket	Black	6360-7742-81	6360-7742-82	6362-7742-81	6362-7742-82	6365-7742-81	6365-7742-82
	Hi Gloss	Black	6360-7742-91	6360-7742-92	6362-7742-91	6362-7742-92	6365-7742-91	6365-7742-92
	STX Tactical	Black	6360-7742-131	6360-7742-132	6362-7742-131	6362-7742-132	6365-7742-131	6365-7742-132
Sig Sauer P225 3.86" BBL	Plain	Black	6360-79-61	6360-79-62	6362-79-61	6362-79-62	6365-79-61	6365-79-62
	Basket	Black	6360-79-81	6360-79-82	6362-79-81	6362-79-82	6365-79-81	6365-79-82
	Hi Gloss	Black	6360-79-91	6360-79-92	6362-79-91	6362-79-92	6365-79-91	6365-79-92
	STX Tactical	Black	6360-79-131	6360-79-132	6362-79-131	6362-79-132	6365-79-131	6365-79-132
Sig Sauer P228, P229 3.9" BBL	Plain	Black	6360-74-61	6360-74-62	6362-74-61	6362-74-62	6365-74-61	6365-74-62
	Basket	Black	6360-74-81	6360-74-82	6362-74-81	6362-74-82	6365-74-81	6365-74-82
	Hi Gloss	Black	6360-74-91	6360-74-92	6362-74-91	6362-74-92	6365-74-91	6365-74-92
	STX Tactical	Black	6360-74-131	6360-74-132	6362-74-131	6362-74-132	6365-74-131	6365-74-132
Sig Sauer P229R DAK .40 w/ Bobbed Hammer; P229R DA/SA .40 w/ Full Size Hammer 3.9" BBL	Plain	Black	6360-447-61	6360-447-62	6362-447-61	6362-447-62	6365-447-61	6365-447-62
	Basket	Black	6360-447-81	6360-447-82	6362-447-81	6362-447-82	6365-447-81	6365-447-82
	Hi Gloss	Black	6360-447-91	6360-447-92	6362-447-91	6362-447-92	6365-447-91	6365-447-92
	STX Tactical	Black	6360-447-131	6360-447-132	6362-447-131	6362-447-132	6365-447-131	6365-447-132
Sig Sauer P229R w/ ITI M3, M3X, TLR-1, TLR-1HL SureFire X200/X300/X300U 3.9" BBL	Plain	Black	6360-7442-61	6360-7442-62	6362-7442-61	6362-7442-62	6365-7442-61	6365-7442-62
	Basket	Black	6360-7442-81	6360-7442-82	6362-7442-81	6362-7442-82	6365-7442-81	6365-7442-82
	Hi Gloss	Black	6360-7442-91	6360-7442-92	6362-7442-91	6362-7442-92	6365-7442-91	6365-7442-92
	STX Tactical	Black	6360-7442-131	6360-7442-132	6362-7442-131	6362-7442-132	6365-7442-131	6365-7442-132
Sig Sauer P239 3.625" BBL	Plain	Black	6360-754-61	6360-754-62	6362-754-61	6362-754-62	6365-754-61	6365-754-62
	Basket	Black	6360-754-81	6360-754-82	6362-754-81	6362-754-82	6365-754-81	6365-754-82
	Hi Gloss	Black	6360-754-91	6360-754-92	6362-754-91	6362-754-92	6365-754-91	6365-754-92
	STX Tactical	Black	6360-754-131	6360-754-132	6362-754-131	6362-754-132	6365-754-131	6365-754-132
Sig Sauer P250 9mm, .40, .45 4.7" BBL	Plain	Black	6360-450-61	6360-450-62	6362-450-61	6362-450-62	6365-450-61	6365-450-62
	Basket	Black	6360-450-81	6360-450-82	6362-450-81	6362-450-82	6365-450-81	6365-450-82
	Hi Gloss	Black	6360-450-91	6360-450-92	6362-450-91	6362-450-92	6365-450-91	6365-450-92
	STX Tactical	Black	6360-450-131	6360-450-132	6362-450-131	6362-450-132	6365-450-131	6365-450-132
Sig Sauer P250 Compact 9mm, .40, .45 3.9" BBL	Plain	Black	6360-750-61	6360-750-62	6362-750-61	6362-750-62	6365-750-61	6365-750-62
	Basket	Black	6360-750-81	6360-750-82	6362-750-81	6362-750-82	6365-750-81	6365-750-82
	Hi Gloss	Black	6360-750-91	6360-750-92	6362-750-91	6362-750-92	6365-750-91	6365-750-92
	STX Tactical	Black	6360-750-131	6360-750-132	6362-750-131	6362-750-132	6365-750-131	6365-750-132
Sig Sauer SP2022 3.87" BBL	Plain	Black	6360-278-61	6360-278-62	6362-278-61	6362-278-62	6365-278-61	6365-278-62
	Basket	Black	6360-278-81	6360-278-82	6362-278-81	6362-278-82	6365-278-81	6365-278-82
	Hi Gloss	Black	6360-278-91	6360-278-92	6362-278-91	6362-278-92	6365-278-91	6365-278-92
	STX Tactical	Black	6360-278-131	6360-278-132	6362-278-131	6362-278-132	6365-278-131	6365-278-132
Sig Sauer P320 9mm, .40 4.7" BBL	Plain	Black	6360-450-61	6360-450-62	6362-450-61	6362-450-62	6365-450-61	6365-450-62
	Basket	Black	6360-450-81	6360-450-82	6362-450-81	6362-450-82	6365-450-81	6365-450-82
	Hi Gloss	Black	6360-450-91	6360-450-92	6362-450-91	6362-450-92	6365-450-91	6365-450-92
	STX Tactical	Black	6360-450-131	6360-450-132	6362-450-131	6362-450-132	6365-450-131	6365-450-132
Sig Sauer P320 9/40 w/ ITI M3, TLR-1, TLR-1HL SureFire X200/X300/X300U 4.7" BBL	Plain	Black	6360-4502-61	6360-4502-62	6362-4502-61	6362-4502-62	6365-4502-61	6365-4502-62
	Basket	Black	6360-4502-81	6360-4502-82	6362-4502-81	6362-4502-82	6365-4502-81	6365-4502-82
	Hi Gloss	Black	6360-4502-91	6360-4502-92	6362-4502-91	6362-4502-92	6365-4502-91	6365-4502-92
	STX Tactical	Black	6360-4502-131	6360-4502-132	6362-4502-131	6362-4502-132	6365-4502-131	6365-4502-132
Sig Sauer P320 Compact & Carry 9mm, .40 3.9" BBL	Plain	Black	6360-750-61	6360-750-62	6362-750-61	6362-750-62	6365-750-61	6365-750-62
	Basket	Black	6360-750-81	6360-750-82	6362-750-81	6362-750-82	6365-750-81	6365-750-82
	Hi Gloss	Black	6360-750-91	6360-750-92	6362-750-91	6362-750-92	6365-750-91	6365-750-92
	STX Tactical	Black	6360-750-131	6360-750-132	6362-750-131	6362-750-132	6365-750-131	6365-750-132
Sig Sauer P320 Compact & Carry 9mm, .40 w/ ITI M3, TLR-1, TLR-1HL SureFire X200/X300/X300U 4.7" BBL	Plain	Black	6360-7502-61	6360-7502-62	6362-7502-61	6362-7502-62	6365-7502-61	6365-7502-62
	Basket	Black	6360-7502-81	6360-7502-82	6362-7502-81	6362-7502-82	6365-7502-81	6365-7502-82
	Hi Gloss	Black	6360-7502-91	6360-7502-92	6362-7502-91	6362-7502-92	6365-7502-91	6365-7502-92
	STX Tactical	Black	6360-7502-131	6360-7502-132	6362-7502-131	6362-7502-132	6365-7502-131	6365-7502-132
Sig Sauer P320 Compact & Carry .45 3.9" BBL	Plain	Black	6360-751-61	6360-751-62	6362-751-61	6362-751-62	6365-751-61	6365-751-62
	Basket	Black	6360-751-81	6360-751-82	6362-751-81	6362-751-82	6365-751-81	6365-751-82
	Hi Gloss	Black	6360-751-91	6360-751-92	6362-751-91	6362-751-92	6365-751-91	6365-751-92
	STX Tactical	Black	6360-751-131	6360-751-132	6362-751-131	6362-751-132	6365-751-131	6365-751-132
Sig Sauer P320 Compact & Carry .45 w/ ITI M3, TLR-1, TLR-1HL SureFire X200/X300/X300U 3.9" BBL	Plain	Black	6360-7512-61	6360-7512-62	6362-7512-61	6362-7512-62	6365-7512-61	6365-7512-62
	Basket	Black	6360-7512-81	6360-7512-82	6362-7512-81	6362-7512-82	6365-7512-81	6365-7512-82
	Hi Gloss	Black	6360-7512-91	6360-7512-92	6362-7512-91	6362-7512-92	6365-7512-91	6365-7512-92
	STX Tactical	Black	6360-7512-131	6360-7512-132	6362-7512-131	6362-7512-132	6365-7512-131	6365-7512-132



Duty Holsters

6360/6362/6365 ALS®/SLS LEVEL III RETENTION™ HOLSTERS FOR: PISTOLS (continued)

How to Order
Duty Holsters
Duty Accessories
Tactical Holsters
Tactical Accessories
Duty Belts
QAS
Speed Loaders
Light Systems
Concealment Holsters
Concealment Accessories
Competition
Apparel
Sales Support
Index/Price List

GUN DESCRIPTION	FINISH*	COLOR	6360 MID-RIDE		6362 HI-RIDE		6365 LOW-RIDE	
			RIGHT	LEFT	RIGHT	LEFT	RIGHT	LEFT
Smith & Wesson M&P 9mm, .40, .22LR 4.25" BBL M&P 9C 3.375" BBL	Plain	Black	6360-219-61	6360-219-62	6362-219-61	6362-219-62	6365-219-61	6365-219-62
	Basket	Black	6360-219-81	6360-219-82	6362-219-81	6362-219-82	6365-219-81	6365-219-82
	Hi Gloss	Black	6360-219-91	6360-219-92	6362-219-91	6362-219-92	6365-219-91	6365-219-92
	STX Tactical	Black	6360-219-131	6360-219-132	6362-219-131	6362-219-132	6365-219-131	6365-219-132
Smith & Wesson M&P 9mm, .40 w/ ITI M3 TLR-1, TLR-1HL SureFire X200/X300/X300U 4.25" BBL	Plain	Black	6360-2192-61	6360-2192-62	6362-2192-61	6362-2192-62	6365-2192-61	6365-2192-62
	Basket	Black	6360-2192-81	6360-2192-82	6362-2192-81	6362-2192-82	6365-2192-81	6365-2192-82
	Hi Gloss	Black	6360-2192-91	6360-2192-92	6362-2192-91	6362-2192-92	6365-2192-91	6365-2192-92
	STX Tactical	Black	6360-2192-131	6360-2192-132	6362-2192-131	6362-2192-132	6365-2192-131	6365-2192-132
Smith & Wesson M&P 9L 5" BBL	Plain	Black	6360-819-61	6360-819-62	6362-819-61	6362-819-62	6365-819-61	6365-819-62
	Basket	Black	6360-819-81	6360-819-82	6362-819-81	6362-819-82	6365-819-81	6365-819-82
	Hi Gloss	Black	6360-819-91	6360-819-92	6362-819-91	6362-819-92	6365-819-91	6365-819-92
	STX Tactical	Black	6360-819-131	6360-819-132	6362-819-131	6362-819-132	6365-819-131	6365-819-132
Smith & Wesson M&P 9L w/ Thumb Safety 5" BBL	Plain	Black	6360-820-61	6360-820-62	6362-820-61	6362-820-62	6365-820-61	6365-820-62
	Basket	Black	6360-820-81	6360-820-82	6362-820-81	6362-820-82	6365-820-81	6365-820-82
	Hi Gloss	Black	6360-820-91	6360-820-92	6362-820-91	6362-820-92	6365-820-91	6365-820-92
	STX Tactical	Black	6360-820-131	6360-820-132	6362-820-131	6362-820-132	6365-820-131	6365-820-132
Smith & Wesson M&P .45 w/o Manual Thumb Safety 4.5" BBL	Plain	Black	6360-419-61	6360-419-62	6362-419-61	6362-419-62	6365-419-61	6365-419-62
	Basket	Black	6360-419-81	6360-419-82	6362-419-81	6362-419-82	6365-419-81	6365-419-82
	Hi Gloss	Black	6360-419-91	6360-419-92	6362-419-91	6362-419-92	6365-419-91	6365-419-92
	STX Tactical	Black	6360-419-131	6360-419-132	6362-419-131	6362-419-132	6365-419-131	6365-419-132
Smith & Wesson M&P .45 w/ Manual Thumb Safety 4.5" BBL	Plain	Black	6360-519-61	6360-519-62	6362-519-61	6362-519-62	6365-519-61	6365-519-62
	Basket	Black	6360-519-81	6360-519-82	6362-519-81	6362-519-82	6365-519-81	6365-519-82
	Hi Gloss	Black	6360-519-91	6360-519-92	6362-519-91	6362-519-92	6365-519-91	6365-519-92
	STX Tactical	Black	6360-519-131	6360-519-132	6362-519-131	6362-519-132	6365-519-131	6365-519-132
Smith & Wesson M&P 45C w/o Thumb Safety 4" BBL	Plain	Black	6360-919-61	6360-919-62	6362-919-61	6362-919-62	6365-919-61	6365-919-62
	Basket	Black	6360-919-81	6360-919-82	6362-919-81	6362-919-82	6365-919-81	6365-919-82
	Hi Gloss	Black	6360-919-91	6360-919-92	6362-919-91	6362-919-92	6365-919-91	6365-919-92
	STX Tactical	Black	6360-919-131	6360-919-132	6362-919-131	6362-919-132	6365-919-131	6365-919-132
Smith & Wesson M&P 45C w/ Thumb Safety 4" BBL	Plain	Black	6360-920-61	6360-920-62	6362-920-61	6362-920-62	6365-920-61	6365-920-62
	Basket	Black	6360-920-81	6360-920-82	6362-920-81	6362-920-82	6365-920-81	6365-920-82
	Hi Gloss	Black	6360-920-91	6360-920-92	6362-920-91	6362-920-92	6365-920-91	6365-920-92
	STX Tactical	Black	6360-920-131	6360-920-132	6362-920-131	6362-920-132	6365-920-131	6365-920-132
Smith & Wesson M&P 45C w/o Thumb Safety, w/ ITI M3, TLR-1, TLR-1HL SureFire X200/X300/X300U 4" BBL	Plain	Black	6360-9192-61	6360-9192-62	6362-9192-61	6362-9192-62	6365-9192-61	6365-9192-62
	Basket	Black	6360-9192-81	6360-9192-82	6362-9192-81	6362-9192-82	6365-9192-81	6365-9192-82
	Hi Gloss	Black	6360-9192-91	6360-9192-92	6362-9192-91	6362-9192-92	6365-9192-91	6365-9192-92
	STX Tactical	Black	6360-9192-131	6360-9192-132	6362-9192-131	6362-9192-132	6365-9192-131	6365-9192-132
Smith & Wesson M&P 45C w/ Thumb Safety, w/ ITI M3, TLR-1, TLR-1HL SureFire X200/X300/X300U 4" BBL	Plain	Black	6360-9202-61	6360-9202-62	6362-9202-61	6362-9202-62	6365-9202-61	6365-9202-62
	Basket	Black	6360-9202-81	6360-9202-82	6362-9202-81	6362-9202-82	6365-9202-81	6365-9202-82
	Hi Gloss	Black	6360-9202-91	6360-9202-92	6362-9202-91	6362-9202-92	6365-9202-91	6365-9202-92
	STX Tactical	Black	6360-9202-131	6360-9202-132	6362-9202-131	6362-9202-132	6365-9202-131	6365-9202-132
Smith & Wesson M&P .45 w/o Thumb Safety, w/ ITI M3, TLR-1, TLR-1HL Insight XTI Procyon, SureFire X200/X300/X300U 4.5" BBL	Plain	Black	6360-4192-61	6360-4192-62	6362-4192-61	6362-4192-62	6365-4192-61	6365-4192-62
	Basket	Black	6360-4192-81	6360-4192-82	6362-4192-81	6362-4192-82	6365-4192-81	6365-4192-82
	Hi Gloss	Black	6360-4192-91	6360-4192-92	6362-4192-91	6362-4192-92	6365-4192-91	6365-4192-92
	STX Tactical	Black	6360-4192-131	6360-4192-132	6362-4192-131	6362-4192-132	6365-4192-131	6365-4192-132
Smith & Wesson M&P .45 w/ Manual Thumb Safety, w/ ITI M3, TLR-1, TLR-1HL Insight XTI Procyon, SureFire X200/X300/X300U 4.5" BBL	Plain	Black	6360-5192-61	6360-5192-62	6362-5192-61	6362-5192-62	6365-5192-61	6365-5192-62
	Basket	Black	6360-5192-81	6360-5192-82	6362-5192-81	6362-5192-82	6365-5192-81	6365-5192-82
	Hi Gloss	Black	6360-5192-91	6360-5192-92	6362-5192-91	6362-5192-92	6365-5192-91	6365-5192-92
	STX Tactical	Black	6360-5192-131	6360-5192-132	6362-5192-131	6362-5192-132	6365-5192-131	6365-5192-132
Smith & Wesson 456T SW w/ Picatinny Rails and ITI M3, TLR-1, TLR-1HL SureFire X200/X300/X300U 4.25" BBL	Plain	Black	6360-4302-61	6360-4302-62	6362-4302-61	6362-4302-62	6365-4302-61	6365-4302-62
	Basket	Black	6360-4302-81	6360-4302-82	6362-4302-81	6362-4302-82	6365-4302-81	6365-4302-82
	Hi Gloss	Black	6360-4302-91	6360-4302-92	6362-4302-91	6362-4302-92	6365-4302-91	6365-4302-92
	STX Tactical	Black	6360-4302-131	6360-4302-132	6362-4302-131	6362-4302-132	6365-4302-131	6365-4302-132
Smith & Wesson 5946, 5943 DAO w/o Rails 4" BBL	Plain	Black	6360-320-61	6360-320-62	6362-320-61	6362-320-62	6365-320-61	6365-320-62
	Basket	Black	6360-320-81	6360-320-82	6362-320-81	6362-320-82	6365-320-81	6365-320-82
	Hi Gloss	Black	6360-320-91	6360-320-92	6362-320-91	6362-320-92	6365-320-91	6365-320-92
	STX Tactical	Black	6360-320-131	6360-320-132	6362-320-131	6362-320-132	6365-320-131	6365-320-132
Smith & Wesson SW99 4" BBL	Plain	Black	6360-84-61	6360-84-62	6362-84-61	6362-84-62	6365-84-61	6365-84-62
	Basket	Black	6360-84-81	6360-84-82	6362-84-81	6362-84-82	6365-84-81	6365-84-82
	Hi Gloss	Black	6360-84-91	6360-84-92	6362-84-91	6362-84-92	6365-84-91	6365-84-92
	STX Tactical	Black	6360-84-131	6360-84-132	6362-84-131	6362-84-132	6365-84-131	6365-84-132



Duty Holsters

6360/6362/6365 ALS®/SLS LEVEL III RETENTION™ HOLSTERS FOR: PISTOLS

How to Order
Duty Holsters
Duty Accessories
Tactical Holsters
Tactical Accessories
Duty Belts
OAS
Speed Loaders
Light Systems
Concealment Holsters
Concealment Accessories
Competition
Apparel
Sales Support
Index/Price List

GUN DESCRIPTION	FINISH*	COLOR	6360 MID-RIDE		6362 HI-RIDE		6365 LOW-RIDE	
			RIGHT	LEFT	RIGHT	LEFT	RIGHT	LEFT
Sphinx SDP-S w/WL1-AA, ITI M3, TLR-1 4.5" BBL	Plain	Black	6360-28115-61	6360-28115-62	6362-28115-61	6362-28115-62	6365-28115-61	6365-28115-62
	Basket	Black	6360-28115-81	6360-28115-82	6362-28115-81	6362-28115-82	6365-28115-81	6365-28115-82
	Hi Gloss	Black	6360-28115-91	6360-28115-92	6362-28115-91	6362-28115-92	6365-28115-91	6365-28115-92
	STX Tactical	Black	6360-28115-131	6360-28115-132	6362-28115-131	6362-28115-132	6365-28115-131	6365-28115-132
Sphinx SDP-S 4.5" BBL	Plain	Black	6360-281-61	6360-281-62	6362-281-61	6362-281-62	6365-281-61	6365-281-62
	Basket	Black	6360-281-81	6360-281-82	6362-281-81	6362-281-82	6365-281-81	6365-281-82
	Hi Gloss	Black	6360-281-91	6360-281-92	6362-281-91	6362-281-92	6365-281-91	6365-281-92
	STX Tactical	Black	6360-281-131	6360-281-132	6362-281-131	6362-281-132	6365-281-131	6365-281-132
Springfield Armory Operator 1911-A1 w/ Picatinny Light Rail 5" BBL	Plain	Black	6360-56-61	6360-56-62	6362-56-61	6362-56-62	6365-56-61	6365-56-62
	Basket	Black	6360-56-81	6360-56-82	6362-56-81	6362-56-82	6365-56-81	6365-56-82
	Hi Gloss	Black	6360-56-91	6360-56-92	6362-56-91	6362-56-92	6365-56-91	6365-56-92
	STX Tactical	Black	6360-56-131	6360-56-132	6362-56-131	6362-56-132	6365-56-131	6365-56-132
Springfield Armory Operator 1911-A1 w/ SureFire X200/X300/X300U 5" BBL	Plain	Black	6360-560-61	6360-560-62	6362-560-61	6362-560-62	6365-560-61	6365-560-62
	Basket	Black	6360-560-81	6360-560-82	6362-560-81	6362-560-82	6365-560-81	6365-560-82
	Hi Gloss	Black	6360-560-91	6360-560-92	6362-560-91	6362-560-92	6365-560-91	6365-560-92
	STX Tactical	Black	6360-560-131	6360-560-132	6362-560-131	6362-560-132	6365-560-131	6365-560-132
Springfield Armory XD, 9mm, .40, .45 4" BBL	Plain	Black	6360-148-61	6360-148-62	6362-148-61	6362-148-62	6365-148-61	6365-148-62
	Basket	Black	6360-148-81	6360-148-82	6362-148-81	6362-148-82	6365-148-81	6365-148-82
	Hi Gloss	Black	6360-148-91	6360-148-92	6362-148-91	6362-148-92	6365-148-91	6365-148-92
	STX Tactical	Black	6360-148-131	6360-148-132	6362-148-131	6362-148-132	6365-148-131	6365-148-132
Springfield Armory XD, 9mm, .40, .357, .45 5" BBL	Plain	Black	6360-149-61	6360-149-62	6362-149-61	6362-149-62	6365-149-61	6365-149-62
	Basket	Black	6360-149-81	6360-149-82	6362-149-81	6362-149-82	6365-149-81	6365-149-82
	Hi Gloss	Black	6360-149-91	6360-149-92	6362-149-91	6362-149-92	6365-149-91	6365-149-92
	STX Tactical	Black	6360-149-131	6360-149-132	6362-149-131	6362-149-132	6365-149-131	6365-149-132
Springfield Armory XD(M) 9mm 4.5" BBL	Plain	Black	6360-145-61	6360-145-62	6362-145-61	6362-145-62	6365-145-61	6365-145-62
	Basket	Black	6360-145-81	6360-145-82	6362-145-81	6362-145-82	6365-145-81	6365-145-82
	Hi Gloss	Black	6360-145-91	6360-145-92	6362-145-91	6362-145-92	6365-145-91	6365-145-92
	STX Tactical	Black	6360-145-131	6360-145-132	6362-145-131	6362-145-132	6365-145-131	6365-145-132
Springfield Armory XD(M) 9mm 3.8" BBL	Plain	Black	6360-148-61	6360-148-62	6362-148-61	6362-148-62	6365-148-61	6365-148-62
	Basket	Black	6360-148-81	6360-148-82	6362-148-81	6362-148-82	6365-148-81	6365-148-82
	Hi Gloss	Black	6360-148-91	6360-148-92	6362-148-91	6362-148-92	6365-148-91	6365-148-92
	STX Tactical	Black	6360-148-131	6360-148-132	6362-148-131	6362-148-132	6365-148-131	6365-148-132
Springfield Armory XD(M) 40 4.5" BBL	Plain	Black	6360-146-61	6360-146-62	6362-146-61	6362-146-62	6365-146-61	6365-146-62
	Basket	Black	6360-146-81	6360-146-82	6362-146-81	6362-146-82	6365-146-81	6365-146-82
	Hi Gloss	Black	6360-146-91	6360-146-92	6362-146-91	6362-146-92	6365-146-91	6365-146-92
	STX Tactical	Black	6360-146-131	6360-146-132	6362-146-131	6362-146-132	6365-146-131	6365-146-132
Springfield Armory XD, 9mm, .40, .45 w/ ITI M3, TLR-1, TLR-1HL SureFire X200/X300/X300U 5" BBL	Plain	Black	6360-1492-61	6360-1492-62	6362-1492-61	6362-1492-62	6365-1492-61	6365-1492-62
	Basket	Black	6360-1492-81	6360-1492-82	6362-1492-81	6362-1492-82	6365-1492-81	6365-1492-82
	Hi Gloss	Black	6360-1492-91	6360-1492-92	6362-1492-91	6362-1492-92	6365-1492-91	6365-1492-92
	STX Tactical	Black	6360-1492-131	6360-1492-132	6362-1492-131	6362-1492-132	6365-1492-131	6365-1492-132
Springfield Armory XD(M) 9mm w/ ITI M3, TLR-1, TLR-1HL SureFire X200/X300/X300U 4.5" BBL	Plain	Black	6360-1452-61	6360-1452-62	6362-1452-61	6362-1452-62	6365-1452-61	6365-1452-62
	Basket	Black	6360-1452-81	6360-1452-82	6362-1452-81	6362-1452-82	6365-1452-81	6365-1452-82
	Hi Gloss	Black	6360-1452-91	6360-1452-92	6362-1452-91	6362-1452-92	6365-1452-91	6365-1452-92
	STX Tactical	Black	6360-1452-131	6360-1452-132	6362-1452-131	6362-1452-132	6365-1452-131	6365-1452-132
Springfield Armory XD 9mm w/ ITI M3, TLR-1, TLR-1HL SureFire X200/X300/X300U 4" BBL	Plain	Black	6360-462-61	6360-462-62	6362-462-61	6362-462-62	6365-462-61	6365-462-62
	Basket	Black	6360-462-81	6360-462-82	6362-462-81	6362-462-82	6365-462-81	6365-462-82
	Hi Gloss	Black	6360-462-91	6360-462-92	6362-462-91	6362-462-92	6365-462-91	6365-462-92
	STX Tactical	Black	6360-462-131	6360-462-132	6362-462-131	6362-462-132	6365-462-131	6365-462-132
Springfield Armory XD, .40, .45 w/ ITI M3, TLR-1, TLR-1HL SureFire X200/X300/X300U 4" BBL	Plain	Black	6360-1482-61	6360-1482-62	6362-1482-61	6362-1482-62	6365-1482-61	6365-1482-62
	Basket	Black	6360-1482-81	6360-1482-82	6362-1482-81	6362-1482-82	6365-1482-81	6365-1482-82
	Hi Gloss	Black	6360-1482-91	6360-1482-92	6362-1482-91	6362-1482-92	6365-1482-91	6365-1482-92
	STX Tactical	Black	6360-1482-131	6360-1482-132	6362-1482-131	6362-1482-132	6365-1482-131	6365-1482-132
Taurus PT840, PT809 4" BBL	Plain	Black	6360-268-61	6360-268-62	6362-268-61	6362-268-62	6365-268-61	6365-268-62
	Basket	Black	6360-268-81	6360-268-82	6362-268-81	6362-268-82	6365-268-81	6365-268-82
	Hi Gloss	Black	6360-268-91	6360-268-92	6362-268-91	6362-268-92	6365-268-91	6365-268-92
	STX Tactical	Black	6360-268-131	6360-268-132	6362-268-131	6362-268-132	6365-268-131	6365-268-132
Walther P99 4" BBL	Plain	Black	6360-84-61	6360-84-62	6362-84-61	6362-84-62	6365-84-61	6365-84-62
	Basket	Black	6360-84-81	6360-84-82	6362-84-81	6362-84-82	6365-84-81	6365-84-82
	Hi Gloss	Black	6360-84-91	6360-84-92	6362-84-91	6362-84-92	6365-84-91	6365-84-92
	STX Tactical	Black	6360-84-131	6360-84-132	6362-84-131	6362-84-132	6365-84-131	6365-84-132
Walther PPQ 4" BBL	Plain	Black	6360-384-61	6360-384-62	6362-384-61	6362-384-62	6365-384-61	6365-384-62
	Basket	Black	6360-384-481	6360-384-482	6362-384-481	6362-384-482	6365-384-481	6365-384-482
	Hi Gloss	Black	6360-384-491	6360-384-492	6362-384-491	6362-384-492	6365-384-491	6365-384-492
	STX Tactical	Black	6360-384-131	6360-384-132	6362-384-131	6362-384-132	6365-384-131	6365-384-132
Walther P99C 3.3" BBL	Plain	Black	6360-284-61	6360-284-62	6362-284-61	6362-284-62	6365-284-61	6365-284-62
	Basket	Black	6360-284-81	6360-284-82	6362-284-81	6362-284-82	6365-284-81	6365-284-82
	Hi Gloss	Black	6360-284-91	6360-284-92	6362-284-91	6362-284-92	6365-284-91	6365-284-92
	STX Tactical	Black	6360-284-131	6360-284-132	6362-284-131	6362-284-132	6365-284-131	6365-284-132
SLS Hood Guard SLS Sentry SLS Hood Guard/Sentry		Black	6000-1	6000-2				
		Black	6001-1	6001-2				
		Black	6002-1	6002-2				



Duty Holsters

6360/6362/6365 RDS ALS®/SLS LEVEL III RETENTION™ HOLSTERS FOR: PISTOLS



PATENTED

6360 MID-RIDE



PATENTED

6362 HI-RIDE



PATENTED

6365 LOW-RIDE

FEATURES

- ▶ ALS® (Automatic Locking System) secures holster once holstered
- ▶ SLS® (Self Locking Systems) Rotating Hood
- ▶ For use with red dot optic-equipped weapons
- ▶ SafariLaminate™ thermal-molded construction protects handgun and sights
- ▶ Suede lined to protect handgun's finish
- ▶ Available in Cordura® Nylon, MultiCam®, Ranger Green, Coyote, Khaki, or Black finishes.
- ▶ Optic Hood Guard (optional)

Models 6360/6362/6365 RDS Duty Holsters include Installed Hood Guard
 Sample Code with Sentry Only Installed:
 6360RDS-83-61-S
 Sample Code with Hood Guard & Sentry Installed:
 6360RDS-83-61-SH

6000

6001

6002

Safariland offers three uniquely designed accessories for the SLS holster system, the 6000 hood Guard, the 6001 Sentry (converting the holster to a higher level of security) and the 6002 hood guard/Sentry combination. Available for SLS models including 6004, 6005, 6034, 6035, 6230, 6235, 6280, 6282, 6287, 7004, 7005, 7280, 7282, 7285, and the 7287. ALS Series SLS holsters including the 6360, 6362, 6365, 6304, 6305, 6354, 6355, 6367, 7304, 7305, 7360, 7362, 7365 and the 7367.

How to Order
Duty Holsters
Duty Accessories
Tactical Holsters
Tactical Accessories
Duty Belts
QAS
Speed Loaders
Light Systems
Concealment Holsters
Concealment Accessories
Competition
Apparel
Sales Support
Index/Price List



Duty Holsters

6360/6362/6365 RDS ALS®/SLS LEVEL III RETENTION™ HOLSTERS

How to Order
Duty Holsters
Duty Accessories
Tactical Holsters
Tactical Accessories
Duty Belts
OAS
Speed Loaders
Light Systems
Concealment Holsters
Concealment Accessories
Competition
Apparel
Sales Support
Index/Price List

GUN DESCRIPTION	FINISH*	COLOR	6360RDS MID-RIDE		6362RDS HI-RIDE		6365RDS LOW-RIDE	
			RIGHT	LEFT	RIGHT	LEFT	RIGHT	LEFT
Glock 17/22 w/ ITI M3 Light, TLR-1, TLR-1HL, SureFire X200/X300/X300U 4.5" BBL	Cordura®	MultiCam®	6360RDS-832-701	6360RDS-832-702	6362RDS-832-701	6362RDS-832-702	6365RDS-832-701	6365RDS-832-702
	Cordura®	Ranger Green	6360RDS-832-731	6360RDS-832-732	6362RDS-832-731	6362RDS-832-732	6365RDS-832-731	6365RDS-832-732
	Cordura®	Coyote	6360RDS-832-741	6360RDS-832-742	6362RDS-832-741	6362RDS-832-742	6365RDS-832-741	6365RDS-832-742
	Cordura®	Khaki	6360RDS-832-751	6360RDS-832-752	6362RDS-832-751	6362RDS-832-752	6365RDS-832-751	6365RDS-832-752
	Cordura®	Black	6360RDS-832-781	6360RDS-832-782	6362RDS-832-781	6362RDS-832-782	6365RDS-832-781	6365RDS-832-782
Glock 19/23 w/ITI M3 Light, TLR-1, TLR-1HL, SureFire X200/X300/X300U 4" BBL	Cordura®	MultiCam®	6360RDS-2832-701	6360RDS-2832-702	6362RDS-2832-701	6362RDS-2832-702	6365RDS-2832-701	6365RDS-2832-702
	Cordura®	Ranger Green	6360RDS-2832-731	6360RDS-2832-732	6362RDS-2832-731	6362RDS-2832-732	6365RDS-2832-731	6365RDS-2832-732
	Cordura®	Coyote	6360RDS-2832-741	6360RDS-2832-742	6362RDS-2832-741	6362RDS-2832-742	6365RDS-2832-741	6365RDS-2832-742
	Cordura®	Khaki	6360RDS-2832-751	6360RDS-2832-752	6362RDS-2832-751	6362RDS-2832-752	6365RDS-2832-751	6365RDS-2832-752
	Cordura®	Black	6360RDS-2832-781	6360RDS-2832-782	6362RDS-2832-781	6362RDS-2832-782	6365RDS-2832-781	6365RDS-2832-782
Glock 34/35 w/ITI M3 Light, TLR-1, TLR-1HL, SureFire X200/X300/X300U 5.32" BBL	Cordura®	MultiCam®	6360RDS-6832-701	6360RDS-6832-702	6362RDS-6832-701	6362RDS-6832-702	6365RDS-6832-701	6365RDS-6832-702
	Cordura®	Ranger Green	6360RDS-6832-731	6360RDS-6832-732	6362RDS-6832-731	6362RDS-6832-732	6365RDS-6832-731	6365RDS-6832-732
	Cordura®	Coyote	6360RDS-6832-741	6360RDS-6832-742	6362RDS-6832-741	6362RDS-6832-742	6365RDS-6832-741	6365RDS-6832-742
	Cordura®	Khaki	6360RDS-6832-751	6360RDS-6832-752	6362RDS-6832-751	6362RDS-6832-752	6365RDS-6832-751	6365RDS-6832-752
	Cordura®	Black	6360RDS-6832-781	6360RDS-6832-782	6362RDS-6832-781	6362RDS-6832-782	6365RDS-6832-781	6365RDS-6832-782
Smith & Wesson M&P 9mm, .40 w/ITI M3 Light, TLR-1, TLR-1HL, SureFire X200/X300/X300U , 4.25" BBL	Cordura®	MultiCam®	6360RDS-2192-701	6360RDS-2192-702	6362RDS-2192-701	6362RDS-2192-702	6365RDS-2192-701	6365RDS-2192-702
	Cordura®	Ranger Green	6360RDS-2192-731	6360RDS-2192-732	6362RDS-2192-731	6362RDS-2192-732	6365RDS-2192-731	6365RDS-2192-732
	Cordura®	Coyote	6360RDS-2192-741	6360RDS-2192-742	6362RDS-2192-741	6362RDS-2192-742	6365RDS-2192-741	6365RDS-2192-742
	Cordura®	Khaki	6360RDS-2192-751	6360RDS-2192-752	6362RDS-2192-751	6362RDS-2192-752	6365RDS-2192-751	6365RDS-2192-752
	Cordura®	Black	6360RDS-2192-781	6360RDS-2192-782	6362RDS-2192-781	6362RDS-2192-782	6365RDS-2192-781	6365RDS-2192-782
Smith & Wesson M&P C.O.R.E w/ITI M3 Light, TLR-1, TLR-1HL, SureFire X200/X300/X300U, 5" BBL	Cordura®	MultiCam®	6360RDS-8192-701	6360RDS-8192-702	6362RDS-8192-701	6362RDS-8192-702	6365RDS-8192-701	6365RDS-8192-702
	Cordura®	Ranger Green	6360RDS-8192-731	6360RDS-8192-732	6362RDS-8192-731	6362RDS-8192-732	6365RDS-8192-731	6365RDS-8192-732
	Cordura®	Coyote	6360RDS-8192-741	6360RDS-8192-742	6362RDS-8192-741	6362RDS-8192-742	6365RDS-8192-741	6365RDS-8192-742
	Cordura®	Khaki	6360RDS-8192-751	6360RDS-8192-752	6362RDS-8192-751	6362RDS-8192-752	6365RDS-8192-751	6365RDS-8192-752
	Cordura®	Black	6360RDS-8192-781	6360RDS-8192-782	6362RDS-8192-781	6362RDS-8192-782	6365RDS-8192-781	6365RDS-8192-782



Duty Holsters

6520 SLS CLIP-ON STYLE LEVEL II RETENTION™



FEATURES

- ▶ Level II Retention™ holster
- ▶ SLS (Self Locking System) Rotating Hood
- ▶ Clip-on style belt loop with ability to fit 1.5" (38mm), 1.75" (45mm), 2" (50mm) or 2.25" (58mm); belt loop is user-adjustable for cant angle
- ▶ Designed for cross draw carry
- ▶ Closed bottom with drain hole to protect cartridge and officer
- ▶ SafariLaminate™ construction with suede lining
- ▶ Available in STX finishes and STX Tactical® (all colors)

The 521-CAP is an EDW Cartridge Accessory Plate allowing holster to clip to a belt and have an extra pouch to hold an additional cartridge. To order on a holster, place -CAP at the end of the part number.
Example: 6520-64-411-CAP

GUN DESCRIPTION	FINISH	COLOR	RIGHT	LEFT
Karbon Arms	STX Plain	Black	6520-263-411	6520-263-412
	STX Basket	Black	6520-263-481	6520-263-482
	STX Hi Gloss	Black	6520-263-491	6520-263-492
	STX Tactical	Black	6520-263-131	6520-263-132
Taser® Advance Taser M26	STX Plain	Black	6520-63-411	6520-63-412
	STX Basket	Black	6520-63-481	6520-63-482
	STX Hi Gloss	Black	6520-63-491	6520-63-492
	STX Tactical	Black	6520-63-131	6520-63-132
Taser® X2	STX Plain	Black	6520-264-411	6520-264-412
	STX Basket	Black	6520-264-481	6520-264-482
	STX Hi Gloss	Black	6520-264-491	6520-264-492
	STX Tactical	Black	6520-264-131	6520-264-132
Taser® X3	STX Plain	Black	6520-163-411	6520-163-412
	STX Basket	Black	6520-163-481	6520-163-482
	STX Hi Gloss	Black	6520-163-491	6520-163-492
	STX Tactical	Black	6520-163-131	6520-163-132
Taser® X26	STX Plain	Black	6520-64-411	6520-64-412
	STX Basket	Black	6520-64-481	6520-64-482
	STX Hi Gloss	Black	6520-64-491	6520-64-492
	STX Tactical	Black	6520-64-131	6520-64-132
Taser® X26P	STX Plain	Black	6520-364-411	6520-364-412
	STX Basket	Black	6520-364-481	6520-364-482
	STX Hi Gloss	Black	6520-364-491	6520-364-492
	STX Tactical	Black	6520-364-131	6520-364-132
	SLS Hood Guard	Black	6000-1	6000-2
	SLS Sentry	Black	6001-1	6001-2
	SLS Hood Guard/Sentry	Black	6002-1	6002-2

- How to Order
- Duty Holsters
- Duty Accessories
- Tactical Holsters
- Tactical Accessories
- Duty Belts
- QAS
- Speed Loaders
- Light Systems
- Concealment Holsters
- Concealment Accessories
- Competition
- Apparel
- Sales Support
- Index/Price List

How to Order
Duty Holsters
Duty Accessories
Tactical Holsters
Tactical Accessories
Duty Belts
OAS
Speed Loaders
Light Systems
Concealment Holsters
Concealment Accessories
Competition
Apparel
Sales Support
Index/Price List

Duty Holsters



7280/7282/7285 7TS™ SLS LEVEL II RETENTION™ HOLSTERS FOR: PISTOLS



PATENT PENDING

7280 MID-RIDE



PATENT PENDING

7282 HI-RIDE



PATENT PENDING

7285 LOW-RIDE

FEATURES

- ▶ Level II Retention™ Holster
- ▶ SLS (Self Locking System) Rotating Hood
- ▶ Level III Retention™ with optional Sentry installed
- ▶ A proprietary nylon blend that is completely non-abrasive to a firearm's finish
- ▶ Raised stand-off surfaces in the interior of the holster to create air space around the weapon allowing dirt and moisture to quickly clear any contact with the firearm
- ▶ Very high heat and low cold tolerances structurally sound from 300° F to -50° F
- ▶ Can be submerged in water indefinitely and still maintain shape and function
- ▶ Matte finish designed to decrease reflection and can be maintained with a simple scouring pad
- ▶ Available in SafariSeven™ Plain Black and FDE Brown finishes

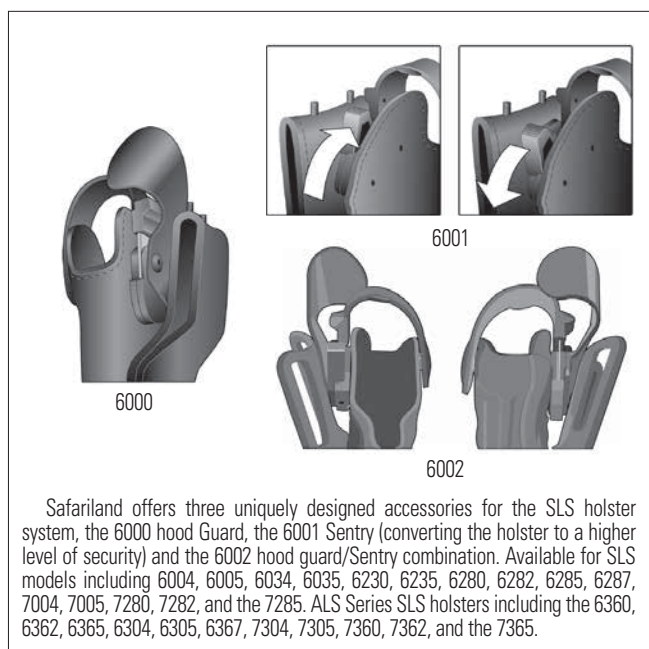

Safariland offers three uniquely designed accessories for the SLS holster system, the 6000 hood Guard, the 6001 Sentry (converting the holster to a higher level of security) and the 6002 hood guard/Sentry combination. Available for SLS models including 6004, 6005, 6034, 6035, 6230, 6235, 6280, 6282, 6285, 6287, 7004, 7005, 7280, 7282, and the 7285. ALS Series SLS holsters including the 6360, 6362, 6365, 6304, 6305, 6367, 7304, 7305, 7360, 7362, and the 7365.

Sample Code with Hood Guard installed:
7280-73-411-H
Sample Code with Sentry installed:
7280-73-411-S
Sample Code with Hood Guard/Sentry installed:
7280-73-411-SH



Duty Holsters

7280/7282/7285 7TS™ SLS LEVEL II RETENTION™ HOLSTERS FOR: PISTOLS

GUN DESCRIPTION	FINISH	COLOR	7280 MID-RIDE		7282 HI-RIDE		7285 LOW-RIDE	
			RIGHT	LEFT	RIGHT	LEFT	RIGHT	LEFT
Beretta 92F, 92FS, 92G, 96, 96G 4.9" BBL	SafariSeven Plain	Black	7280-73-411	7280-73-412	7282-73-411	7282-73-412	7285-73-411	7285-73-412
	SafariSeven Plain	FDE Brown	7280-73-551	7280-73-552	7282-73-551	7282-73-552	7285-73-551	7285-73-552
Glock 17, 22 4.5" BBL	SafariSeven Plain	Black	7280-83-411	7280-83-412	7282-83-411	7282-83-412	7285-83-411	7285-83-412
	SafariSeven Plain	FDE Brown	7280-83-551	7280-83-552	7282-83-551	7282-83-552	7285-83-551	7285-83-552
	SafariSeven Basket	Black	7280-83-481	7280-83-482	7282-83-481	7282-83-482	7285-83-481	7285-83-482
Glock 17,22 w/ XC-1 Surefire Light 4.5" BBL	SafariSeven Plain	Black	7280-8322-411	7280-8322-412	7282-8322-411	7282-8322-412	7285-8322-411	7285-8322-412
	SafariSeven Plain	FDE Brown	7280-8322-551	7280-8322-552	7282-8322-551	7282-8322-552	7285-8322-551	7285-8322-552
	SafariSeven Basket	Black	7280-8322-481	7280-8322-482	7282-8322-481	7282-8322-482	7285-8322-481	7285-8322-482
	SafariSeven Hi-Gloss	Black	7280-8322-491	7280-8322-492	7282-8322-491	7282-8322-492	7285-8322-491	7285-8322-492
Glock 17, 22 w/ ITI M3, TLR-1 TLR-1HL, SureFire X200/X300/X300U 4.5" BBL	SafariSeven Plain	Black	7280-832-411	7280-832-412	7282-832-411	7282-832-412	7285-832-411	7285-832-412
	SafariSeven Plain	FDE Brown	7280-832-551	7280-832-552	7282-832-551	7282-832-552	7285-832-551	7285-832-552
	SafariSeven Basket	Black	7280-832-481	7280-832-482	7282-832-481	7282-832-482	7285-832-481	7285-832-482
	SafariSeven Hi-Gloss	Black	7280-832-491	7280-832-492	7282-832-491	7282-832-492	7285-832-491	7285-832-492
Glock 19, 23 4" BBL	SafariSeven Plain	Black	7280-283-411	7280-283-412	7282-283-411	7282-283-412	7285-283-411	7285-283-412
	SafariSeven Plain	FDE Brown	7280-283-551	7280-283-552	7282-283-551	7282-283-552	7285-283-551	7285-283-552
	SafariSeven Basket	Black	7280-283-481	7280-283-482	7282-283-481	7282-283-482	7285-283-481	7285-283-482
Glock 19,23 w/ XC-1 Surefire Light 4" BBL	SafariSeven Plain	Black	7280-28322-411	7280-28322-412	7282-28322-411	7282-28322-412	7285-28322-411	7285-28322-412
	SafariSeven Plain	FDE Brown	7280-28322-551	7280-28322-552	7282-28322-551	7282-28322-552	7285-28322-551	7285-28322-552
	SafariSeven Basket	Black	7280-28322-481	7280-28322-482	7282-28322-481	7282-28322-482	7285-28322-481	7285-28322-482
	SafariSeven Hi-Gloss	Black	7280-28322-491	7280-28322-492	7282-28322-491	7282-28322-492	7285-28322-491	7285-28322-492
Glock 20/21 4.5" BBL	SafariSeven Plain	Black	7280-383-411	7280-383-412	7282-383-411	7282-383-412	7285-383-411	7285-383-412
	SafariSeven Plain	FDE Brown	7280-383-551	7280-383-552	7282-383-551	7282-383-552	7285-383-551	7285-383-552
	SafariSeven Basket	Black	7280-383-481	7280-383-482	7282-383-481	7282-383-482	7285-383-481	7285-383-482
	SafariSeven Hi-Gloss	Black	7280-383-491	7280-383-492	7282-383-491	7282-383-492	7285-383-491	7285-383-492
Glock 20, 21 w/ITI M3, TLR-1, TLR-1HL, SureFire X200/X300/X300U 4.6" BBL	SafariSeven Plain	Black	7280-3832-411	7280-3832-412	7282-3832-411	7282-3832-412	7285-3832-411	7285-3832-412
	SafariSeven Plain	FDE Brown	7280-3832-551	7280-3832-552	7282-3832-551	7282-3832-552	7285-3832-551	7285-3832-552
	SafariSeven Basket	Black	7280-3832-481	7280-3832-482	7282-3832-481	7282-3832-482	7285-3832-481	7285-3832-482
	SafariSeven Hi-Gloss	Black	7280-3832-491	7280-3832-492	7282-3832-491	7282-3832-492	7285-3832-491	7285-3832-492
Glock 19, 23 w/ ITI M3, TLR-1 TLR-1HL, SureFire X200/X300/X300U 4" BBL	SafariSeven Plain	Black	7280-2832-411	7280-2832-412	7282-2832-411	7282-2832-412	7285-2832-411	7285-2832-412
	SafariSeven Plain	FDE Brown	7280-2832-551	7280-2832-552	7282-2832-551	7282-2832-552	7285-2832-551	7285-2832-552
	SafariSeven Basket	Black	7280-2832-481	7280-2832-482	7282-2832-481	7282-2832-482	7285-2832-481	7285-2832-482
	SafariSeven Hi-Gloss	Black	7280-2832-491	7280-2832-492	7282-2832-491	7282-2832-492	7285-2832-491	7285-2832-492
Glock 34, 35 w/ ITI M3, TLR-1 SureFire X200/X300/X300U 5.31" BBL	SafariSeven Plain	Black	7280-832-411	7280-832-412	7282-832-411	7282-832-412	7285-832-411	7285-832-412
	SafariSeven Plain	FDE Brown	7280-832-551	7280-832-552	7282-832-551	7282-832-552	7285-832-551	7285-832-552
	SafariSeven Basket	Black	7280-832-481	7280-832-482	7282-832-481	7282-832-482	7285-832-481	7285-832-482
	SafariSeven Hi-Gloss	Black	7280-832-491	7280-832-492	7282-832-491	7282-832-492	7285-832-491	7285-832-492
Glock 41 w/ITI M3, TLR-1 TLR-1HL, SureFire X200/X300/X300U 5.31" BBL	SafariSeven Plain	Black	7280-832-411	7280-832-412	7282-832-411	7282-832-412	7285-832-411	7285-832-412
	SafariSeven Plain	FDE Brown	7280-832-551	7280-832-552	7282-832-551	7282-832-552	7285-832-551	7285-832-552
	SafariSeven Basket	Black	7280-832-481	7280-832-482	7282-832-481	7282-832-482	7285-832-481	7285-832-482
Heckler & Koch P30 3.78" BBL	SafariSeven Plain	Black	7280-295-411	7280-295-412	7282-295-411	7282-295-412	7285-295-411	7285-295-412
	SafariSeven Plain	FDE Brown	7280-295-551	7280-295-552	7282-295-551	7282-295-552	7285-295-551	7285-295-552
	SafariSeven Plain	Black	7280-197-411	7280-197-411	7282-197-411	7282-197-411	7285-197-411	7285-197-411
Heckler & Koch P2000 DAO 3.5" BBL	SafariSeven Plain	FDE Brown	7280-197-551	7280-197-551	7282-197-551	7282-197-551	7285-197-551	7285-197-551
	SafariSeven Plain	Black	7280-397-411	7280-397-412	7282-397-411	7282-397-412	7285-397-411	7285-397-412
Heckler & Koch P2000 DA/SA 3.5" BBL	SafariSeven Plain	FDE Brown	7280-397-551	7280-397-552	7282-397-551	7282-397-552	7285-397-551	7285-397-552
	SafariSeven Plain	Black	7280-291-411	7280-291-412	7282-291-411	7282-291-412	7285-291-411	7285-291-412
Heckler & Koch USP 9C/40C DAO 4.25" BBL	SafariSeven Plain	FDE Brown	7280-291-551	7280-291-552	7282-291-551	7282-291-552	7285-291-551	7285-291-552
	SafariSeven Plain	Black	7280-391-411	7280-391-412	7282-391-411	7282-391-412	7285-391-411	7285-391-412
Heckler & Koch USP 9C/40C DA/SA 4.25" BBL	SafariSeven Plain	FDE Brown	7280-391-551	7280-391-552	7282-391-551	7282-391-552	7285-391-551	7285-391-552
	SafariSeven Plain	Black	7280-593-411	7280-593-412	7282-593-411	7282-593-412	7285-593-411	7285-593-412
Heckler & Koch VP9 4.09" BBL	SafariSeven Plain	FDE Brown	7280-593-551	7280-593-552	7282-593-551	7282-593-552	7285-593-551	7285-593-552

How to Order
Duty Holsters
Duty Accessories
Tactical Holsters
Tactical Accessories
Duty Bats
QAS
Speed Loaders
Light Systems
Concealment Holsters
Concealment Accessories
Competition
Apparel
Sales Support
Index/Price List



Duty Holsters

7280/7282/7285 7TS™ SLS LEVEL II RETENTION™ HOLSTERS FOR: PISTOLS

How to Order
Duty Holsters
Duty Accessories
Tactical Holsters
Tactical Accessories
Duty Belts
OAS
Speed Loaders
Light Systems
Concealment Holsters
Concealment Accessories
Competition
Apparel
Sales Support
Index/Price List

GUN DESCRIPTION	FINISH*	COLOR	7280 MID-RIDE		7282 HI-RIDE		7285 LOW-RIDE	
			RIGHT	LEFT	RIGHT	LEFT	RIGHT	LEFT
Ruger American 9mm, .40, 4.5" BBL	SafariSeven Plain	Black	7280-167-411	7280-167-412	7282-167-411	7282-167-412	7285-167-411	7285-167-412
	SafariSeven Plain	FDE Brown	7280-167-551	7280-167-552	7282-167-551	7282-167-552	7285-167-551	7285-167-552
Ruger American .45 4.5" BBL	SafariSeven Plain	Black	7280-168-411	7280-168-412	7282-168-411	7282-168-412	7285-168-411	7285-168-412
	SafariSeven Plain	FDE Brown	7280-168-551	7280-168-552	7282-168-551	7282-168-552	7285-168-551	7285-168-552
Sig Sauer P220, P226, P220R, P226R, P226R MK25 9mm, .40 4.41" BBL	SafariSeven Plain	Black	7280-477-411	7280-477-412	7282-477-411	7282-477-412	7285-477-411	7285-477-412
	SafariSeven Plain	FDE Brown	7280-477-551	7280-477-552	7282-477-551	7282-477-552	7285-477-551	7285-477-552
Sig Sauer P220, P220R w/ ITI M3, TLR-1, TLR-1HL, Surefire X200, X300, X300U, 4.41" BBL	SafariSeven Plain	Black	7280-7702-411	7280-7702-412	7282-7702-411	7282-7702-412	7285-7702-411	7285-7702-412
	SafariSeven Plain	FDE Brown	7280-7702-551	7280-7702-552	7282-7702-551	7282-7702-552	7285-7702-551	7285-7702-552
	SafariSeven Basket	Black	7280-7702-481	7280-7702-482	7282-7702-481	7282-7702-482	7285-7702-481	7285-7702-482
	SafariSeven Hi-Gloss	Black	7280-7702-491	7280-7702-492	7282-7702-491	7282-7702-492	7285-7702-491	7285-7702-492
Sig Sauer P226, P226R, P226R MK 9mm, .40 w/ITI M3, TLR-1, TLR-1HL, Surefire X200, X300, X300U 4.41" BBL	SafariSeven Plain	Black	7280-4772-411	7280-4772-412	7282-4772-411	7282-4772-412	7285-4772-411	7285-4772-412
	SafariSeven Plain	FDE Brown	7280-4772-551	7280-4772-552	7282-4772-551	7282-4772-552	7285-4772-551	7285-4772-552
	SafariSeven Basket	Black	7280-4772-481	7280-4772-482	7282-4772-481	7282-4772-482	7285-4772-481	7285-4772-482
	SafariSeven Hi-Gloss	Black	7280-4772-491	7280-4772-492	7282-4772-491	7282-4772-492	7285-4772-491	7285-4772-492
Sig Sauer P227, P227 R3 w/ ITI M3, TLR-1, TLR-1HL, Surefire X200, X300, X300U 3.9" BBL	SafariSeven Plain	Black	7280-6772-411	7280-6772-412	7282-6772-411	7282-6772-412	7285-6772-411	7285-6772-412
	SafariSeven Plain	FDE Brown	7280-6772-551	7280-6772-552	7282-6772-551	7282-6772-552	7285-6772-551	7285-6772-552
	SafariSeven Basket	Black	7280-6772-481	7280-6772-482	7282-6772-481	7282-6772-482	7285-6772-481	7285-6772-482
	SafariSeven Hi-Gloss	Black	7280-6772-491	7280-6772-492	7282-6772-491	7282-6772-492	7285-6772-491	7285-6772-492
Sig Sauer P229R DAK, P229R E2 9mm, 3.9" BBL	SafariSeven Plain	Black	7280-474-411	7280-474-412	7282-474-411	7282-474-412	7285-474-411	7285-474-412
	SafariSeven Plain	FDE Brown	7280-474-551	7280-474-552	7282-474-551	7282-474-552	7285-474-551	7285-474-552
Sig Sauer P229, P229DAK, P229R 9mm w/ITI M3, TLR-1, TLR-1HL, Surefire X200, X300, X300U 3.9" BBL	SafariSeven Plain	Black	7280-4742-411	7280-4742-412	7282-4742-411	7282-4742-412	7285-4742-411	7285-4742-412
	SafariSeven Plain	FDE Brown	7280-4742-551	7280-4742-552	7282-4742-551	7282-4742-552	7285-4742-551	7285-4742-552
	SafariSeven Basket	Black	7280-4742-481	7280-4742-482	7282-4742-481	7282-4742-482	7285-4742-481	7285-4742-482
	SafariSeven Hi-Gloss	Black	7280-4742-491	7280-4742-492	7282-4742-491	7282-4742-492	7285-4742-491	7285-4742-492
Sig Sauer P229, P229R, 40 3.9" BBL	SafariSeven Plain	Black	7280-447-411	7280-447-412	7282-447-411	7282-447-412	7285-447-411	7285-447-412
	SafariSeven Plain	FDE Brown	7280-447-551	7280-447-552	7282-447-551	7282-447-552	7285-447-551	7285-447-552
Sig Sauer P229, P229R .40 w/ ITI M3, TLR-1, TLR-1HL, Surefire X200, X300, X300U, 3.9" BBL	SafariSeven Plain	Black	7280-4472-411	7280-4472-412	7282-4472-411	7282-4472-412	7285-4472-411	7285-4472-412
	SafariSeven Plain	FDE Brown	7280-4472-551	7280-4472-552	7282-4472-551	7282-4472-552	7285-4472-551	7285-4472-552
	SafariSeven Basket	Black	7280-4472-481	7280-4472-482	7282-4472-481	7282-4472-482	7285-4472-481	7285-4472-482
	SafariSeven Hi-Gloss	Black	7280-4472-491	7280-4472-492	7282-4472-491	7282-4472-492	7285-4472-491	7285-4472-492
Sig Sauer P320 Full Size 9mm, .40 4.7" BBL	SafariSeven Plain	Black	7280-450-411	7280-450-412	7282-450-411	7282-450-412	7285-450-411	7285-450-412
	SafariSeven Plain	FDE Brown	7280-450-551	7280-450-552	7282-450-551	7282-450-552	7285-450-551	7285-450-552
Sig Sauer P320 Full Size 9mm, .40 w/ ITI M3, TLR-1, TLR-1HL Surefire X200/X300/X300U, 4.7" BBL	SafariSeven Plain	Black	7280-4502-411	7280-4502-412	7282-4502-411	7282-4502-412	7285-4502-411	7285-4502-412
	SafariSeven Plain	FDE Brown	7280-4502-551	7280-4502-552	7282-4502-551	7282-4502-552	7285-4502-551	7285-4502-552
	SafariSeven Basket	Black	7280-4502-481	7280-4502-482	7282-4502-481	7282-4502-482	7285-4502-481	7285-4502-482
	SafariSeven Hi-Gloss	Black	7280-4502-481	7280-4502-482	7282-4502-481	7282-4502-482	7285-4502-481	7285-4502-482
Sig Sauer P320 Compact & Carry 9mm, .40 3.9" BBL	SafariSeven Plain	Black	7280-750-411	7280-750-412	7282-750-411	7282-750-412	7285-750-411	7285-750-412
	SafariSeven Plain	FDE Brown	7280-750-551	7280-750-552	7282-750-551	7282-750-552	7285-750-551	7285-750-552
Sig Sauer P320 Compact & Carry 9mm, .40 w/ ITI M3, TLR-1, TLR-1HL Surefire X200/X300/X300U, 4.7" BBL	SafariSeven Plain	Black	7280-7502-411	7280-7502-412	7282-7502-411	7282-7502-412	7285-7502-411	7285-7502-412
	SafariSeven Plain	FDE Brown	7280-7502-551	7280-7502-552	7282-7502-551	7282-7502-552	7285-7502-551	7285-7502-552
	SafariSeven Basket	Black	7280-7502-481	7280-7502-482	7282-7502-481	7282-7502-482	7285-7502-481	7285-7502-482
	SafariSeven Hi-Gloss	Black	7280-7502-491	7280-7502-492	7282-7502-491	7282-7502-492	7285-7502-491	7285-7502-492



Duty Holsters

7280/7282/7285 7TS™ SLS LEVEL II RETENTION™ HOLSTERS FOR: PISTOLS (continued)

GUN DESCRIPTION	FINISH*	COLOR	7280 MID-RIDE		7282 HI-RIDE		7285 LOW-RIDE	
			RIGHT	LEFT	RIGHT	LEFT	RIGHT	LEFT
Sig Sauer P320 Full Size .45 3.9" BBL	SafariSeven Plain	Black	7280-451-411	7280-451-412	7282-451-411	7282-451-412	7285-451-411	7285-451-412
	SafariSeven Plain	FDE Brown	7280-451-551	7280-451-552	7282-451-551	7282-451-552	7285-451-551	7285-451-552
Sig Sauer P320 Full Size .45 w/ ITI M3, TLR-1, TLR-1HL Surefire X200/X300/ X300U , 3.9" BBL	SafariSeven Plain	Black	7280-4512-411	7280-4512-412	7282-4512-411	7282-4512-412	7285-4512-411	7285-4512-412
	SafariSeven Plain	FDE Brown	7280-4512-551	7280-4512-552	7282-4512-551	7282-4512-552	7285-4512-551	7285-4512-552
	SafariSeven Basket	Black	7280-4512-481	7280-4512-482	7282-4512-481	7282-4512-482	7285-4512-481	7285-4512-482
	SafariSeven Hi-Gloss	Black	7280-4512-491	7280-4512-492	7282-4512-491	7282-4512-492	7285-4512-491	7285-4512-492
Sig Sauer P320 Compact & Carry .45 3.9" BBL	SafariSeven Plain	Black	7280-751-411	7280-751-412	7282-751-411	7282-751-412	7285-751-411	7285-751-412
	SafariSeven Plain	FDE Brown	7280-751-551	7280-751-552	7282-751-551	7282-751-552	7285-751-551	7285-751-552
Sig Sauer P320 Compact & Carry .45 w/ ITI M3, TLR-1, TLR-1HL Surefire X200/X300/X300U 3.9" BBL	SafariSeven Plain	Black	7280-7512-411	7280-7512-412	7282-7512-411	7282-7512-412	7285-7512-411	7285-7512-412
	SafariSeven Plain	FDE Brown	7280-7512-551	7280-7512-552	7282-7512-551	7282-7512-552	7285-7512-551	7285-7512-552
	SafariSeven Basket	Black	7280-7512-481	7280-7512-482	7282-7512-481	7282-7512-482	7285-7512-481	7285-7512-482
	SafariSeven Hi-Gloss	Black	7280-7512-491	7280-7512-492	7282-7512-491	7282-7512-492	7285-7512-491	7285-7512-492
Smith & Wesson M&P 45 4.5" BBL	SafariSeven Plain	Black	7280-419-411	7280-419-412	7282-419-411	7282-419-412	7285-419-411	7285-419-412
	SafariSeven Plain	FDE Brown	7280-419-551	7280-419-552	7282-419-551	7282-419-552	7285-419-551	7285-419-552
	SafariSeven Basket	Black	7280-419-481	7280-419-482	7282-419-481	7282-419-482	7285-419-481	7285-419-482
Smith & Wesson M&P .45 w/ITI M3, TLR-1, TLR-1HL, Surefire X200, X300, X300U 3.9" BBL	SafariSeven Plain	Black	7280-4192-411	7280-4192-412	7282-4192-411	7282-4192-412	7285-4192-411	7285-4192-412
	SafariSeven Plain	FDE Brown	7280-4192-551	7280-4192-552	7282-4192-551	7282-4192-552	7285-4192-551	7285-4192-552
	SafariSeven Basket	Black	7280-4192-481	7280-4192-482	7282-4192-481	7282-4192-482	7285-4192-481	7285-4192-482
Smith & Wesson M&P 9L, .40L 5" BBL	SafariSeven Plain	Black	7280-819-411	7280-819-412	7282-819-411	7282-819-412	7285-819-411	7285-819-412
	SafariSeven Plain	FDE Brown	7280-819-551	7280-819-552	7282-819-551	7282-819-552	7285-819-551	7285-819-552
Smith & Wesson M&P 9L, .40L w/ITI M3, TLR-1, TLR-1HL, Surefire X200, X300, X300U 5" BBL	SafariSeven Plain	Black	7280-8192-411	7280-8192-412	7282-8192-411	7282-8192-412	7285-8192-411	7285-8192-412
	SafariSeven Plain	FDE Brown	7280-8192-551	7280-8192-552	7282-8192-551	7282-8192-552	7285-8192-551	7285-8192-552
	SafariSeven Basket	Black	7280-8192-481	7280-8192-482	7282-8192-481	7282-8192-482	7285-8192-481	7285-8192-482
Smith & Wesson M&P 9mm, .40 4.25" BBL	SafariSeven Plain	Black	7280-219-411	7280-219-412	7282-219-411	7282-219-412	7285-219-411	7285-219-412
	SafariSeven Plain	FDE Brown	7280-219-551	7280-219-552	7282-219-551	7282-219-552	7285-219-551	7285-219-552
Smith & Wesson M&P 9mm, .40 w/ XC-1 Surefire Light 4.25" BBL	SafariSeven Plain	Black	7280-21922-411	7280-21922-412	7282-21922-411	7282-21922-412	7285-21922-411	7285-21922-412
	SafariSeven Plain	FDE Brown	7280-21922-551	7280-21922-552	7282-21922-551	7282-21922-552	7285-21922-551	7285-21922-552
	SafariSeven Basket	Black	7280-21922-481	7280-21922-482	7282-21922-481	7282-21922-482	7285-21922-481	7285-21922-482
	SafariSeven Hi-Gloss	Black	7280-21922-491	7280-21922-492	7282-21922-491	7282-21922-492	7285-21922-491	7285-21922-492
Smith & Wesson M&P 9/40 w/ ITI M3, TLR-1, TLR-1HL, SureFire X200/X300/X300U 4" BBL	SafariSeven Plain	Black	7280-2192-411	7280-2192-412	7282-2192-411	7282-2192-412	7285-2192-411	7285-2192-412
	SafariSeven Plain	FDE Brown	7280-2192-551	7280-2192-552	7282-2192-551	7282-2192-552	7285-2192-551	7285-2192-552
	SafariSeven Basket	Black	7280-2192-481	7280-2192-482	7282-2192-481	7282-2192-482	7285-2192-481	7285-2192-482
	SafariSeven Hi-Gloss	Black	7280-7512-491	7280-7512-492	7282-7512-491	7282-7512-492	7285-7512-491	7285-7512-492
Smith & Wesson M&P 45C 4" BBL	SafariSeven Plain	Black	7280-919-411	7280-919-412	7282-919-411	7282-919-412	7285-919-411	7285-919-412
	SafariSeven Plain	FDE Brown	7280-919-551	7280-919-552	7282-919-551	7282-919-552	7285-919-551	7285-919-552
	SafariSeven Basket	Black	7280-919-481	7280-919-482	7282-919-481	7282-919-482	7285-919-481	7285-919-482
Walther P99Q 4" BBL	SafariSeven Plain	Black	7280-384-411	7280-384-412	7282-384-411	7282-384-412	7285-384-411	7285-384-412
	SafariSeven Plain	FDE Brown	7280-384-551	7280-384-552	7282-384-551	7282-384-552	7285-384-551	7285-384-552
Walther P99Q 5" BBL	SafariSeven Plain	Black	7280-385-411	7280-385-412	7282-385-411	7282-385-412	7285-385-411	7285-385-412
	SafariSeven Plain	FDE Brown	7280-385-551	7280-385-552	7282-385-551	7282-385-552	7285-385-551	7285-385-552

How to Order
Duty Holsters
Duty Accessories
Tactical Holsters
Tactical Accessories
Duty Belts
DAS
Speed Loaders
Light Systems
Concealment Holsters
Concealment Accessories
Competition
Apparel
Sales Support
Index/Price List

How to Order
Duty Holsters
Duty Accessories
Tactical Holsters
Tactical Accessories
Duty Belts
OAS
Speed Loaders
Light Systems
Concealment Holsters
Concealment Accessories
Competition
Apparel
Sales Support
Index/Price List

Duty Holsters



7360/7362/7365 7TS™ ALS®/SLS LEVEL III RETENTION™ HOLSTERS FOR: PISTOLS



PATENTED & PATENT PENDING

7360 MID-RIDE



PATENTED & PATENT PENDING

7362 HI-RIDE



PATENTED & PATENT PENDING

7365 LOW-RIDE

FEATURES

- ▶ Level III Retention™ Holster
- ▶ ALS® (Automatic Locking System) secures weapon once holstered, simple straight up draw once release is deactivated
- ▶ SLS (Self Locking System) Rotating Hood
- ▶ Level IV Retention with optional Sentry installed
- ▶ Hood Guard is standard
- ▶ A proprietary nylon blend that is completely non-abrasive to a firearm's finish
- ▶ Raised stand-off surfaces in the interior of the holster to create air space around the weapon allowing dirt and moisture to quickly clear any contact with the firearm
- ▶ Very high heat and low cold tolerances structurally sound from 300° F to -50° F
- ▶ Can be submerged in water indefinitely and still maintain shape and function
- ▶ Matte finish designed to decrease reflection and can be maintained with a simple scouring pad
- ▶ Available in SafariSeven™ Plain Black and FDE Brown finishes

Models 7360/7362/7365 Duty Holsters include Installed Hood Guard
 Sample Code with Sentry Only Installed:
 7360-83-411-S
 Sample Code with Hood Guard & Sentry Installed:
 7360-83-411-SH

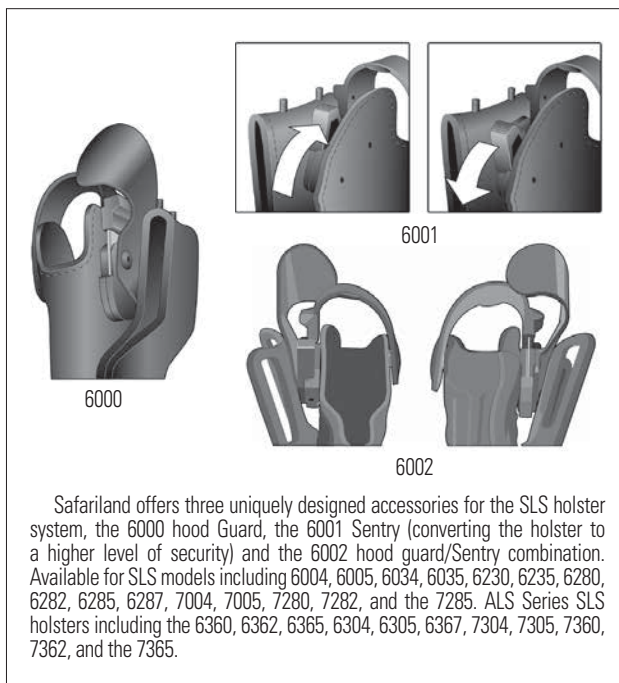

Safariland offers three uniquely designed accessories for the SLS holster system, the 6000 hood Guard, the 6001 Sentry (converting the holster to a higher level of security) and the 6002 hood guard/Sentry combination. Available for SLS models including 6004, 6005, 6034, 6035, 6230, 6235, 6280, 6282, 6285, 6287, 7004, 7005, 7280, 7282, and the 7285. ALS Series SLS holsters including the 6360, 6362, 6365, 6304, 6305, 6367, 7304, 7305, 7360, 7362, and the 7365.



Duty Holsters

7360/7362/7365 7TS™ ALS®/SLS LEVEL III RETENTION™ HOLSTERS FOR: PISTOLS (continued)

GUN DESCRIPTION	FINISH	COLOR	7360 MID-RIDE		7362 HI-RIDE		7365 LOW-RIDE	
			RIGHT	LEFT	RIGHT	LEFT	RIGHT	LEFT
Beretta 92F, 92FS, 92G, 96, 96G 4.9" BBL	SafariSeven Plain	Black	7360-73-411	7360-73-412	7362-73-411	7362-73-412	7365-73-411	7365-73-412
	SafariSeven Plain	FDE Brown	7360-73-551	7360-73-552	7362-73-551	7362-73-552	7365-73-551	7365-73-552
Glock 17, 22 4.5" BBL	SafariSeven Plain	Black	7360-83-411	7360-83-412	7362-83-411	7362-83-412	7365-83-411	7365-83-412
	SafariSeven Plain	FDE Brown	7360-83-551	7360-83-552	7362-83-551	7362-83-552	7365-83-551	7365-83-552
	SafariSeven Basket	Black	7360-83-481	7360-83-482	7362-83-481	7362-83-482	7365-83-481	7365-83-482
Glock 17, 22 w/ ITI M3, TLR-1, TLR-1HL, SureFire X200/X300/X300U 4.5" BBL	SafariSeven Plain	Black	7360-832-411	7360-832-412	7362-832-411	7362-832-412	7365-832-411	7365-832-412
	SafariSeven Plain	FDE Brown	7360-832-551	7360-832-552	7362-832-551	7362-832-552	7365-832-551	7365-832-552
	SafariSeven Basket	Black	7360-832-481	7360-832-482	7362-832-481	7362-832-482	7365-832-481	7365-832-482
	SafariSeven Hi-Gloss	Black	7360-832-491	7360-832-492	7362-832-491	7362-832-492	7365-832-491	7365-832-492
Glock 17,22 w/ XC-1 Surefire Light 4.5" BBL	SafariSeven Plain	Black	7360-8322-411	7360-8322-412	7362-8322-411	7362-8322-412	7365-8322-411	7365-8322-412
	SafariSeven Plain	FDE Brown	7360-8322-551	7360-8322-552	7362-8322-551	7362-8322-552	7365-8322-551	7365-8322-552
	SafariSeven Basket	Black	7360-8322-481	7360-8322-482	7362-8322-481	7362-8322-482	7365-8322-481	7365-8322-482
	SafariSeven Hi-Gloss	Black	7360-8322-491	7360-8322-492	7362-8322-491	7362-8322-492	7365-8322-491	7365-8322-492
Glock 19, 23 4" BBL	SafariSeven Plain	Black	7360-283-411	7360-283-412	7362-283-411	7362-283-412	7365-283-411	7365-283-412
	SafariSeven Plain	FDE Brown	7360-283-551	7360-283-552	7362-283-551	7362-283-552	7365-283-551	7365-283-552
	SafariSeven Basket	Black	7360-283-481	7360-283-482	7362-283-481	7362-283-482	7365-283-481	7365-283-482
Glock 19, 23 w/ ITI M3, TLR-1, TLR-1HL, SureFire X200/X300/X300U 4" BBL	SafariSeven Plain	Black	7360-2832-411	7360-2832-412	7362-2832-411	7362-2832-412	7365-2832-411	7365-2832-412
	SafariSeven Plain	FDE Brown	7360-2832-551	7360-2832-552	7362-2832-551	7362-2832-552	7365-2832-551	7365-2832-552
	SafariSeven Basket	Black	7360-2832-481	7360-2832-482	7362-2832-481	7362-2832-482	7365-2832-481	7365-2832-482
	SafariSeven Hi-Gloss	Black	7360-2832-491	7360-2832-492	7362-2832-491	7362-2832-492	7365-2832-491	7365-2832-492
Glock 19,23 w/ XC-1 Surefire Light 4" BBL	SafariSeven Plain	Black	7360-28322-411	7360-28322-412	7362-28322-411	7362-28322-412	7365-28322-411	7365-28322-412
	SafariSeven Plain	FDE Brown	7360-28322-551	7360-28322-552	7362-28322-551	7362-28322-552	7365-28322-551	7365-28322-552
	SafariSeven Basket	Black	7360-28322-481	7360-28322-482	7362-28322-481	7362-28322-482	7365-28322-481	7365-28322-482
	SafariSeven Hi-Gloss	Black	7360-28322-491	7360-28322-492	7362-28322-491	7362-28322-492	7365-28322-491	7365-28322-492
Glock 20/21 4.6" BBL	SafariSeven Plain	Black	7360-383-411	7360-383-412	7362-383-411	7362-383-412	7365-383-411	7365-383-412
	SafariSeven Plain	FDE Brown	7360-383-551	7360-383-552	7362-383-551	7362-383-552	7365-383-551	7365-383-552
	SafariSeven Basket	Black	7360-383-481	7360-383-482	7362-383-481	7362-383-482	7365-383-481	7365-383-482
	SafariSeven Hi-Gloss	Black	7360-383-491	7360-383-492	7362-383-491	7362-383-492	7365-383-491	7365-383-492
Glock 20, 21 w/ITI M3, TLR-1, TLR-1HL SureFire X200/ X300/X300U 4.6" BBL	SafariSeven Plain	Black	7360-3832-411	7360-3832-412	7362-3832-411	7362-3832-412	7365-3832-411	7365-3832-412
	SafariSeven Plain	FDE Brown	7360-3832-551	7360-3832-552	7362-3832-551	7362-3832-552	7365-3832-551	7365-3832-552
	SafariSeven Basket	Black	7360-3832-481	7360-3832-482	7362-3832-481	7362-3832-482	7365-3832-481	7365-3832-482
	SafariSeven Hi-Gloss	Black	7360-3832-491	7360-3832-492	7362-3832-491	7362-3832-492	7365-3832-491	7365-3832-492
Glock 34, 35 w/ ITI M3, TLR-1, TLR-1HL, SureFire X200/X300/X300U 5.31" BBL	SafariSeven Plain	Black	7360-832-411	7360-832-412	7362-832-411	7362-832-412	7365-832-411	7365-832-412
	SafariSeven Plain	FDE Brown	7360-832-551	7360-832-552	7362-832-551	7362-832-552	7365-832-551	7365-832-552
	SafariSeven Basket	Black	7360-832-481	7360-832-482	7362-832-481	7362-832-482	7365-832-481	7365-832-482
	SafariSeven Hi-Gloss	Black	7360-832-491	7360-832-492	7362-832-491	7362-832-492	7365-832-491	7365-832-492
Glock 41 w/ ITI M3, TLR-1, TLR-1HL, SureFire X200/X300/X300U 5.31" BBL	SafariSeven Plain	Black	7360-832-411	7360-832-412	7362-832-411	7362-832-412	7365-832-411	7365-832-412
	SafariSeven Plain	FDE Brown	7360-832-551	7360-832-552	7362-832-551	7362-832-552	7365-832-551	7365-832-552
	SafariSeven Basket	Black	7360-832-481	7360-832-482	7362-832-481	7362-832-482	7365-832-481	7365-832-482
Heckler & Koch P30 3.78" BBL	SafariSeven Plain	Black	7360-295-411	7360-295-412	7362-295-411	7362-295-412	7365-295-411	7365-295-412
	SafariSeven Plain	FDE Brown	7360-295-551	7360-295-552	7362-295-551	7362-295-552	7365-295-551	7365-295-552
Heckler & Koch P2000 DAO 3.5" BBL	SafariSeven Plain	Black	7360-197-411	7360-197-412	7362-197-411	7362-197-412	7365-197-411	7365-197-412
	SafariSeven Plain	FDE Brown	7360-197-551	7360-197-552	7362-197-551	7362-197-552	7365-197-551	7365-197-552
Heckler & Koch P2000 DA/SA 3.5" BBL	SafariSeven Plain	Black	7360-397-411	7360-397-412	7362-397-411	7362-397-412	7365-397-411	7365-397-412
	SafariSeven Plain	FDE Brown	7360-397-551	7360-397-552	7362-397-551	7362-397-552	7365-397-551	7365-397-552
Heckler & Koch USP 9C/40C DAO 4.25" BBL	SafariSeven Plain	Black	7360-291-411	7360-291-412	7362-291-411	7362-291-412	7365-291-411	7365-291-412
	SafariSeven Plain	FDE Brown	7360-291-551	7360-291-552	7362-291-551	7362-291-552	7365-291-551	7365-291-552
Heckler & Koch USP 9C/40C DA/SA 4.25" BBL	SafariSeven Plain	Black	7360-391-411	7360-391-412	7362-391-411	7362-391-412	7365-391-411	7365-391-412
	SafariSeven Plain	FDE Brown	7360-391-551	7360-391-552	7362-391-551	7362-391-552	7365-391-551	7365-391-552
Heckler & Koch VP9 4.09" BBL	SafariSeven Plain	Black	7360-593-411	7360-593-412	7362-593-411	7362-593-412	7365-593-411	7365-593-412
	SafariSeven Plain	FDE Brown	7360-593-551	7360-593-552	7362-593-551	7362-593-552	7365-593-551	7365-593-552

How to Order
Duty Holsters
Duty Accessories
Tactical Holsters
Tactical Accessories
Duty Belts
DAS
Speed Loaders
Light Systems
Concealment Holsters
Concealment Accessories
Competition
Apparel
Sales Support
Index/Price List



Duty Holsters

7360/7362/7365 7TS™ ALS®/SLS LEVEL III RETENTION™ HOLSTERS FOR: PISTOLS (continued)

How to Order
Duty Holsters
Duty Accessories
Tactical Holsters
Tactical Accessories
Duty Belts
OAS
Speed Loaders
Light Systems
Concealment Holsters
Concealment Accessories
Competition
Apparel
Sales Support
Index/Price List

GUN DESCRIPTION	FINISH	COLOR	7360 MID-RIDE		7362 HI-RIDE		7365 LOW-RIDE	
			RIGHT	LEFT	RIGHT	LEFT	RIGHT	LEFT
Ruger American 9mm, .40, 4.5" BBL	SafariSeven Plain SafariSeven Plain	Black FDE Brown	7360-167-411 7360-167-551	7360-167-412 7360-167-552	7362-167-411 7362-167-551	7362-167-412 7362-167-552	7365-167-411 7365-167-551	7365-167-412 7365-167-552
Ruger American .45 4.5" BBL	SafariSeven Plain SafariSeven Plain	Black FDE Brown	7360-168-411 7360-168-551	7360-168-412 7360-168-552	7362-168-411 7362-168-551	7362-168-412 7362-168-552	7365-168-411 7365-168-551	7365-168-412 7365-168-552
Sig Sauer P226, P226R, P226R MK 9mm, .40 w/ITI M3, TLR-1, TLR-1HL, SafariSeven Hi-Gloss Surefire X200, X300, X300U 4.41" BBL	SafariSeven Plain SafariSeven Plain SafariSeven Basket SafariSeven Hi-Gloss	Black FDE Brown Black Black	7360-4772-411 7360-4772-551 7360-4772-481 7360-4772-491	7360-4772-412 7360-4772-552 7360-4772-482 7360-4772-492	7362-4772-411 7362-4772-551 7362-4772-481 7362-4772-491	7362-4772-412 7362-4772-552 7362-4772-482 7362-4772-492	7365-4772-411 7365-4772-551 7365-4772-481 7365-4772-491	7365-4772-412 7365-4772-552 7365-4772-482 7365-4772-492
Sig Sauer P220, P220R w/ITI M3, TLR-1, TLR-1HL, Surefire X200, X300, X300U, 4.41" BBL	SafariSeven Plain SafariSeven Plain SafariSeven Basket SafariSeven Hi-Gloss	Black FDE Brown Black Black	7360-7702-411 7360-7702-551 7360-7702-481 7360-7702-491	7360-7702-412 7360-7702-552 7360-7702-482 7360-7702-492	7362-7702-411 7362-7702-551 7362-7702-481 7362-7702-491	7362-7702-412 7362-7702-552 7362-7702-482 7362-7702-492	7365-7702-411 7365-7702-551 7365-7702-481 7365-7702-491	7365-7702-412 7365-7702-552 7365-7702-482 7365-7702-492
Sig Sauer P227, P227 R3 w/ITI M3, TLR-1, TLR-1HL, Surefire X200, X300, X300U, 3.9" BBL	SafariSeven Plain SafariSeven Plain SafariSeven Basket SafariSeven Hi-Gloss	Black FDE Brown Black Black	7360-6772-411 7360-6772-551 7360-6772-481 7360-6772-491	7360-6772-412 7360-6772-552 7360-6772-482 7360-6772-492	7362-6772-411 7362-6772-551 7362-6772-481 7362-6772-491	7362-6772-412 7362-6772-552 7362-6772-482 7362-6772-492	7365-6772-411 7365-6772-551 7365-6772-481 7365-6772-491	7365-6772-412 7365-6772-552 7365-6772-482 7365-6772-492
Sig Sauer P229R DAK, P229R E2 9mm, 3.9" BBL	SafariSeven Plain SafariSeven Plain	Black FDE Brown	7360-474-411 7360-474-551	7360-474-412 7360-474-552	7362-474-411 7362-474-551	7362-474-412 7362-474-552	7365-474-411 7365-474-551	7365-474-412 7365-474-552
Sig Sauer P229, P229DAK, P229R 9mm w/ITI M3, TLR-1, TLR-1HL, Surefire X200, X300, X300U 3.9" BBL	SafariSeven Plain SafariSeven Plain SafariSeven Basket SafariSeven Hi-Gloss	Black FDE Brown Black Black	7360-4742-411 7360-4742-551 7360-4742-481 7360-4742-491	7360-4742-412 7360-4742-552 7360-4742-482 7360-4742-492	7362-4742-411 7362-4742-551 7362-4742-481 7362-4742-491	7362-4742-412 7362-4742-552 7362-4742-482 7362-4742-492	7365-4742-411 7365-4742-551 7365-4742-481 7365-4742-491	7365-4742-412 7365-4742-552 7365-4742-482 7365-4742-492
Sig Sauer P229, P229R, .40 3.9" BBL	SafariSeven Plain SafariSeven Plain	Black FDE Brown	7360-447-411 7360-447-551	7360-447-412 7360-447-552	7362-447-411 7362-447-551	7362-447-412 7362-447-552	7365-447-411 7365-447-551	7365-447-412 7365-447-552
Sig Sauer P229, P229R .40 w/ITI M3, TLR-1, TLR-1HL, Surefire X200, X300, X300U, 3.9" BBL	SafariSeven Plain SafariSeven Plain SafariSeven Basket SafariSeven Hi-Gloss	Black FDE Brown Black Black	7360-4472-411 7360-4472-551 7360-4472-481 7360-4472-491	7360-4472-412 7360-4472-552 7360-4472-482 7360-4472-492	7362-4472-411 7362-4472-551 7362-4472-481 7362-4472-491	7362-4472-412 7362-4472-552 7362-4472-482 7362-4472-492	7365-4472-411 7365-4472-551 7365-4472-481 7365-4472-491	7365-4472-412 7365-4472-552 7365-4472-482 7365-4472-492
Sig Sauer P220, P226, P220R, P226R, P226R MK25 9mm, .40 4.41" BBL P227 R3 .45 3.9" BBL	SafariSeven Plain SafariSeven Plain	Black FDE Brown	7360-477-411 7360-477-551	7360-477-412 7360-477-552	7362-477-411 7362-477-551	7362-477-412 7362-477-552	7365-477-411 7365-477-551	7365-477-412 7365-477-552
Sig Sauer P320 Full Size 9mm, .40 4.7" BBL	SafariSeven Plain SafariSeven Plain	Black FDE Brown	7360-450-411 7360-450-551	7360-450-412 7360-450-552	7362-450-411 7362-450-551	7362-450-412 7362-450-552	7365-450-411 7365-450-551	7365-450-412 7365-450-552
Sig Sauer P320 Full Size 9mm, .40 w/ITI M3, TLR-1, TLR-1HL Surefire X200/X300/X300U 4.7" BBL	SafariSeven Plain SafariSeven Plain SafariSeven Basket SafariSeven Hi-Gloss	Black FDE Brown Black Black	7360-4502-411 7360-4502-551 7360-4502-481 7360-4502-491	7360-4502-412 7360-4502-552 7360-4502-482 7360-4502-492	7362-4502-411 7362-4502-551 7362-4502-481 7362-4502-491	7362-4502-412 7362-4502-552 7362-4502-482 7362-4502-492	7365-4502-411 7365-4502-551 7365-4502-481 7365-4502-491	7365-4502-412 7365-4502-552 7365-4502-482 7365-4502-492
Sig Sauer P320 Compact & Carry 9mm, .40 3.9" BBL	SafariSeven Plain SafariSeven Plain	Black FDE Brown	7360-750-411 7360-750-551	7360-750-412 7360-750-552	7362-750-411 7362-750-551	7362-750-412 7362-750-552	7365-750-411 7365-750-551	7365-750-412 7365-750-552
Sig Sauer P320 Compact & Carry 9mm, .40 w/ITI M3, TLR-1, TLR-1HL Surefire X200/X300/X300U 4.7" BBL	SafariSeven Plain SafariSeven Plain SafariSeven Basket SafariSeven Hi-Gloss	Black FDE Brown Black Black	7360-7502-411 7360-7502-551 7360-7502-481 7360-7502-491	7360-7502-412 7360-7502-552 7360-7502-482 7360-7502-492	7362-7502-411 7362-7502-551 7362-7502-481 7362-7502-491	7362-7502-412 7362-7502-552 7362-7502-482 7362-7502-492	7365-7502-411 7365-7502-551 7365-7502-481 7365-7502-491	7365-7502-412 7365-7502-552 7365-7502-482 7365-7502-492



Duty Holsters

7360/7362/7365 7TS™ ALS®/SLS LEVEL III RETENTION™ HOLSTERS FOR: PISTOLS (continued)

GUN DESCRIPTION	FINISH	COLOR	7360 MID-RIDE		7362 HI-RIDE		7365 LOW-RIDE	
			RIGHT	LEFT	RIGHT	LEFT	RIGHT	LEFT
Sig Sauer P320 Full Size .45 3.9" BBL	SafariSeven Plain	Black	7360-451-411	7360-451-412	7362-451-411	7362-451-412	7365-451-411	7365-451-412
	SafariSeven Plain	FDE Brown	7360-451-551	7360-451-552	7362-451-551	7362-451-552	7365-451-551	7365-451-552
Sig Sauer P320 Full Size .45 w/ ITI M3, TLR-1, TLR-1HL Surefire X200/X300/ X300U, 3.9" BBL	SafariSeven Plain	Black	7360-4512-411	7360-4512-412	7362-4512-411	7362-4512-412	7365-4512-411	7365-4512-412
	SafariSeven Plain	FDE Brown	7360-4512-551	7360-4512-552	7362-4512-551	7362-4512-552	7365-4512-551	7365-4512-552
	SafariSeven Basket	Black	7360-4512-481	7360-4512-482	7362-4512-481	7362-4512-482	7365-4512-481	7365-4512-482
	SafariSeven Hi-Gloss	Black	7360-4512-491	7360-4512-492	7362-4512-491	7362-4512-492	7365-4512-491	7365-4512-492
Sig Sauer P320 Compact & Carry .45 3.9" BBL	SafariSeven Plain	Black	7360-751-411	7360-751-412	7362-751-411	7362-751-412	7365-751-411	7365-751-412
	SafariSeven Plain	FDE Brown	7360-751-551	7360-751-552	7362-751-551	7362-751-552	7365-751-551	7365-751-552
Sig Sauer P320 Compact & Carry .45 w/ ITI M3, TLR-1, TLR-1HL Surefire X200/X300/ X300U, 3.9" BBL	SafariSeven Plain	Black	7360-7512-411	7360-7512-412	7362-7512-411	7362-7512-412	7365-7512-411	7365-7512-412
	SafariSeven Plain	FDE Brown	7360-7512-551	7360-7512-552	7362-7512-551	7362-7512-552	7365-7512-551	7365-7512-552
	SafariSeven Basket	Black	7360-7512-481	7360-7512-482	7362-7512-481	7362-7512-482	7365-7512-481	7365-7512-482
	SafariSeven Hi-Gloss	Black	7360-7512-491	7360-7512-492	7362-7512-491	7362-7512-492	7365-7512-491	7365-7512-492
Smith & Wesson M&P 45 4.5" BBL	SafariSeven Plain	Black	7360-419-411	7360-419-412	7362-419-411	7362-419-412	7365-419-411	7365-419-412
	SafariSeven Plain	FDE Brown	7360-419-551	7360-419-552	7362-419-551	7362-419-552	7365-419-551	7365-419-552
	SafariSeven Basket	Black	7360-419-481	7360-419-482	7362-419-481	7362-419-482	7365-419-481	7365-419-482
Smith & Wesson M&P .45 w/ITI M3, TLR-1, TLR-1HL, Surefire X200, X300, X300U 3.9" BBL	SafariSeven Plain	Black	7360-4192-411	7360-4192-412	7362-4192-411	7362-4192-412	7365-4192-411	7365-4192-412
	SafariSeven Plain	FDE Brown	7360-4192-551	7360-4192-552	7362-4192-551	7362-4192-552	7365-4192-551	7365-4192-552
	SafariSeven Basket	Black	7360-4192-481	7360-4192-482	7362-4192-481	7362-4192-482	7365-4192-481	7365-4192-482
Smith & Wesson M&P 9L, .40L 5" BBL	SafariSeven Plain	Black	7360-819-411	7360-819-412	7362-819-411	7362-819-412	7365-819-411	7365-819-412
	SafariSeven Plain	FDE Brown	7360-819-551	7360-819-552	7362-819-551	7362-819-552	7365-819-551	7365-819-552
Smith & Wesson M&P 9L, .40L w/ ITI M3, TLR-1, TLR-1HL, Surefire X200, X300, X300U 5" BBL	SafariSeven Plain	Black	7360-8192-411	7360-8192-412	7362-8192-411	7362-8192-412	7365-8192-411	7365-8192-412
	SafariSeven Plain	FDE Brown	7360-8192-551	7360-8192-552	7362-8192-551	7362-8192-552	7365-8192-551	7365-8192-552
	SafariSeven Basket	Black	7360-8192-481	7360-8192-482	7362-8192-481	7362-8192-482	7365-8192-481	7365-8192-482
Smith & Wesson M&P 9mm, .40 4.25" BBL	SafariSeven Plain	Black	7360-219-411	7360-219-412	7362-219-411	7362-219-412	7365-219-411	7365-219-412
	SafariSeven Plain	FDE Brown	7360-219-551	7360-219-552	7362-219-551	7362-219-552	7365-219-551	7365-219-552
Smith & Wesson M&P 9mm, .40 w/ XC-1 Surefire Light 4.25" BBL	SafariSeven Plain	Black	7360-21922-411	7360-21922-412	7362-21922-411	7362-21922-412	7365-21922-411	7365-21922-412
	SafariSeven Plain	FDE Brown	7360-21922-551	7360-21922-552	7362-21922-551	7362-21922-552	7365-21922-551	7365-21922-552
	SafariSeven Basket	Black	7360-21922-481	7360-21922-482	7362-21922-481	7362-21922-482	7365-21922-481	7365-21922-482
	SafariSeven Hi-Gloss	Black	7360-21922-491	7360-21922-492	7362-21922-491	7362-21922-492	7365-21922-491	7365-21922-492
Smith & Wesson M&P 9/40 w/ ITI M3, TLR-1, TLR-1HL, SureFire X200/X300/X300U 4.25" BBL	SafariSeven Plain	Black	7360-2192-411	7360-2192-412	7362-2192-411	7362-2192-412	7365-2192-411	7365-2192-412
	SafariSeven Plain	FDE Brown	7360-2192-551	7360-2192-552	7362-2192-551	7362-2192-552	7365-2192-551	7365-2192-552
	SafariSeven Basket	Black	7360-2192-481	7360-2192-482	7362-2192-481	7362-2192-482	7365-2192-481	7365-2192-482
	SafariSeven Basket	Black	7360-2192-491	7360-2192-492	7362-2192-491	7362-2192-492	7365-2192-491	7365-2192-492
Smith & Wesson M&P 45C 4" BBL	SafariSeven Plain	Black	7360-919-411	7360-919-412	7362-919-411	7362-919-412	7365-919-411	7365-919-412
	SafariSeven Plain	FDE Brown	7360-919-551	7360-919-552	7362-919-551	7362-919-552	7365-919-551	7365-919-552
	SafariSeven Basket	Black	7360-919-481	7360-919-482	7362-919-481	7362-919-482	7365-919-481	7365-919-482
Walther P99Q 4" BBL	SafariSeven Plain	Black	7360-384-411	7360-384-412	7362-384-411	7362-384-412	7365-384-411	7365-384-412
	SafariSeven Plain	FDE Brown	7360-384-551	7360-384-552	7362-384-551	7362-384-552	7365-384-551	7365-384-552
Walther P99Q 5" BBL	SafariSeven Plain	Black	7360-385-411	7360-385-412	7362-385-411	7362-385-412	7365-385-411	7365-385-412
	SafariSeven Plain	FDE Brown	7360-385-551	7360-385-552	7362-385-551	7362-385-552	7365-385-551	7365-385-552

How to
Order
Duty
Holsters
Duty
Accessories
Tactical
Holsters
Tactical
Accessories
Duty
Bats
QAS
Speed
Loaders
Light
Systems
Concealment
Holsters
Concealment
Accessories
Competition
Apparel
Sales
Support
Index/
Price
List

How to Order
Duty Holsters
Duty Accessories
Tactical Holsters
Tactical Accessories
Duty Belts
OAS
Speed Loaders
Light Systems
Concealment Holsters
Concealment Accessories
Competition
Apparel
Sales Support
Index/Price List

Duty Holsters



7390/7392/7395 7TS™ALS® LEVEL I RETENTION™ DUTY HOLSTERS FOR: PISTOLS



PATENTED & PATENT PENDING

7390 MID-RIDE



PATENTED & PATENT PENDING

7392 HI-RIDE



PATENTED & PATENT PENDING

7395 LOW-RIDE

FEATURES

- ▶ Level I Retention™ Holster
- ▶ ALS® (Automatic Locking System) secures weapon once holstered, simple straight up draw once release is deactivated
- ▶ Open-top design without SLS for quick retrieval of weapon
- ▶ Optional ALS Guard available for increasing level of security by on to a Level II Retention™
- ▶ A proprietary nylon blend that is completely non-abrasive to a firearm's finish
- ▶ Very high heat and low cold tolerances structurally sound from 300° F to -50° F
- ▶ Raised stand-off surfaces in the interior of the holster to create air space around the weapon allowing dirt and moisture to quickly clear any contact with the firearm
- ▶ Can be submerged in water indefinitely and still maintain shape and function
- ▶ Matte finish designed to decrease reflection and can be maintained with a simple Scotch-Brite type pad
- ▶ Available in SafariSeven™ Plain Black and FDE Brown finishes

Models 7390/7392/7395 Duty Holsters include installed Hood Guard
 Sample Code with ALS Guard Only:
 7390-83-411-AG
 Sample Code with Hood Guard & ALS Guard:
 7390-83-411-AGH



ALS Guard – Unlocked

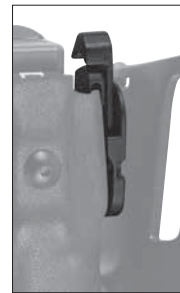

ALS Guard – Locked



Duty Holsters

7390/7392/7395 7TS™ALS® LEVEL I RETENTION™ DUTY HOLSTERS FOR: PISTOLS

GUN DESCRIPTION	FINISH	COLOR	7280 MID-RIDE		7282 HI-RIDE		7285 LOW-RIDE	
			RIGHT	LEFT	RIGHT	LEFT	RIGHT	LEFT
Beretta 92F, 92FS, 92G, 96, 96G 4.9" BBL	SafariSeven Plain	Black	7390-73-411	7390-73-412	7392-73-411	7392-73-412	7395-73-411	7395-73-412
	SafariSeven Plain	FDE Brown	7390-73-551	7390-73-552	7392-73-551	7392-73-552	7395-73-551	7395-73-552
Glock 17, 22 4.5" BBL	SafariSeven Plain	Black	7390-83-411	7390-83-412	7392-83-411	7392-83-412	7395-83-411	7395-83-412
	SafariSeven Plain	FDE Brown	7390-83-551	7390-83-552	7392-83-551	7392-83-552	7395-83-551	7395-83-552
	SafariSeven Basket	Basket	7390-83-481	7390-83-482	7392-83-481	7392-83-482	7395-83-481	7395-83-482
Glock 19, 23 4" BBL	SafariSeven Plain	Black	7390-283-411	7390-283-412	7392-283-411	7392-283-412	7395-283-411	7395-283-412
	SafariSeven Plain	FDE Brown	7390-283-551	7390-283-552	7392-283-551	7392-283-552	7395-283-551	7395-283-552
	SafariSeven Basket	Basket	7390-283-481	7390-283-482	7392-283-481	7392-283-482	7395-283-481	7395-283-482
Glock 26, 27 3.5" BBL	SafariSeven Plain	Black	7390-183-411	7390-183-412	7392-183-411	7392-183-412	7395-183-411	7395-183-412
	SafariSeven Plain	FDE Brown	7390-183-551	7390-183-552	7392-183-551	7392-183-552	7395-183-551	7395-183-552
Glock 17, 22 w/ ITI M3, TLR-1, TLR-1HL, SureFire X200/X300/X300U 4.5" BBL	SafariSeven Plain	Black	7390-832-411	7390-832-412	7392-832-411	7392-832-412	7395-832-411	7395-832-412
	SafariSeven Plain	FDE Brown	7390-832-551	7390-832-552	7392-832-551	7392-832-552	7395-832-551	7395-832-552
	SafariSeven Basket	Black	7390-832-481	7390-832-482	7392-832-481	7392-832-482	7395-832-481	7395-832-482
	SafariSeven Hi-Gloss	Black	7390-832-491	7390-832-492	7392-832-491	7392-832-492	7395-832-491	7395-832-492
Glock 17,22 w/ XC-1 Surefire Light 4.5" BBL	SafariSeven Plain	Black	7390-8322-411	7390-8322-412	7392-8322-411	7392-8322-412	7395-8322-411	7395-8322-412
	SafariSeven Plain	FDE Brown	7390-8322-551	7390-8322-552	7392-8322-551	7392-8322-552	7395-8322-551	7395-8322-552
	SafariSeven Basket	Black	7390-8322-481	7390-8322-482	7392-8322-481	7392-8322-482	7395-8322-481	7395-8322-482
	SafariSeven Hi-Gloss	Black	7390-8322-491	7390-8322-492	7392-8322-491	7392-8322-492	7395-8322-491	7395-8322-492
Glock 19, 23 w/ ITI M3, TLR-1, TLR-1HL, SureFire X200/X300/X300U 4" BBL	SafariSeven Plain	Black	7390-2832-411	7390-2832-412	7392-2832-411	7392-2832-412	7395-2832-411	7395-2832-412
	SafariSeven Plain	FDE Brown	7390-2832-551	7390-2832-552	7392-2832-551	7392-2832-552	7395-2832-551	7395-2832-552
	SafariSeven Basket	Black	7390-2832-481	7390-2832-482	7392-2832-481	7392-2832-482	7395-2832-481	7395-2832-482
	SafariSeven Hi-Gloss	Black	7390-2832-491	7390-2832-492	7392-2832-491	7392-2832-492	7395-2832-491	7395-2832-492
Glock 19,23 w/ XC-1 Surefire Light 4" BBL	SafariSeven Plain	Black	7390-28322-411	7390-28322-412	7392-28322-411	7392-28322-412	7395-28322-411	7395-28322-412
	SafariSeven Plain	FDE Brown	7390-28322-551	7390-28322-552	7392-28322-551	7392-28322-552	7395-28322-551	7395-28322-552
	SafariSeven Basket	Black	7390-28322-481	7390-28322-482	7392-28322-481	7392-28322-482	7395-28322-481	7395-28322-482
	SafariSeven Hi-Gloss	Black	7390-28322-491	7390-28322-492	7392-28322-491	7392-28322-492	7395-28322-491	7395-28322-492
Glock 20, 21 w/ITI M3, TLR-1, TLR-1HL, SureFire X200/X300/X300U 4.6" BBL	SafariSeven Plain	Black	7390-3832-411	7390-3832-412	7392-3832-411	7392-3832-412	7395-3832-411	7395-3832-412
	SafariSeven Plain	FDE Brown	7390-3832-551	7390-3832-552	7392-3832-551	7392-3832-552	7395-3832-551	7395-3832-552
	SafariSeven Basket	Black	7390-3832-481	7390-3832-482	7392-3832-481	7392-3832-482	7395-3832-481	7395-3832-482
	SafariSeven Hi-Gloss	Black	7390-3832-491	7390-3832-492	7392-3832-491	7392-3832-492	7395-3832-491	7395-3832-492
Glock 20,21 4.6" BBL	SafariSeven Plain	Black	7390-383-411	7390-383-412	7392-383-411	7392-383-412	7395-383-411	7395-383-412
	SafariSeven Plain	FDE Brown	7390-383-551	7390-383-552	7392-383-551	7392-383-552	7395-383-551	7395-383-552
	SafariSeven Basket	Black	7390-383-481	7390-383-482	7392-383-481	7392-383-482	7395-383-481	7395-383-482
	SafariSeven Hi-Gloss	Black	7390-383-491	7390-383-492	7392-383-491	7392-383-492	7395-383-491	7395-383-492
Glock 34, 35 w/ ITI M3, TLR-1 TLR-1HL, SureFire X200/X300/X300U 5.31" BBL	SafariSeven Plain	Black	7390-832-411	7390-832-412	7392-832-411	7392-832-412	7395-832-411	7395-832-412
	SafariSeven Plain	FDE Brown	7390-832-551	7390-832-552	7392-832-551	7392-832-552	7395-832-551	7395-832-552
	SafariSeven Basket	Black	7390-832-481	7390-832-482	7392-832-481	7392-832-482	7395-832-481	7395-832-482
	SafariSeven Hi-Gloss	Black	7390-832-491	7390-832-492	7392-832-491	7392-832-492	7395-832-491	7395-832-492
Glock 41 w/ ITI M3, TLR-1 TLR-1HL, SureFire X200/X300/X300U 5.31" BBL	SafariSeven Plain	Black	7390-832-411	7390-832-412	7392-832-411	7392-832-412	7395-832-411	7395-832-412
	SafariSeven Plain	FDE Brown	7390-832-551	7390-832-552	7392-832-551	7392-832-552	7395-832-551	7395-832-552
	SafariSeven Basket	Black	7390-832-481	7390-832-482	7392-832-481	7392-832-482	7395-832-481	7395-832-482
	SafariSeven Hi-Gloss	Black	7390-832-491	7390-832-492	7392-832-491	7392-832-492	7395-832-491	7395-832-492
Heckler & Koch P30 3.78" BBL	SafariSeven Plain	Black	7390-295-411	7390-295-412	7392-295-411	7392-295-412	7395-295-411	7395-295-412
	SafariSeven Plain	FDE Brown	7390-295-551	7390-295-552	7392-295-551	7392-295-552	7395-295-551	7395-295-552
Heckler & Koch P2000 DAO 3.5" BBL	SafariSeven Plain	Black	7390-197-411	7390-197-412	7392-197-411	7392-197-412	7395-197-411	7395-197-412
	SafariSeven Plain	FDE Brown	7390-197-551	7390-197-552	7392-197-551	7392-197-552	7395-197-551	7395-197-552
Heckler & Koch P2000 DA/SA 3.5" BBL	SafariSeven Plain	Black	7390-397-411	7390-397-412	7392-397-411	7392-397-412	7395-397-411	7395-397-412
	SafariSeven Plain	FDE Brown	7390-397-551	7390-397-552	7392-397-551	7392-397-552	7395-397-551	7395-397-552
Heckler & Koch USP 9C/40C DAO 4.25" BBL	SafariSeven Plain	Black	7390-291-411	7390-291-412	7392-291-411	7392-291-412	7395-291-411	7395-291-412
	SafariSeven Plain	FDE Brown	7390-291-551	7390-291-552	7392-291-551	7392-291-552	7395-291-551	7395-291-552

How to Order
Duty Holsters
Duty Accessories
Tactical Holsters
Tactical Accessories
Duty Bats
QAS
Speed Loaders
Light Systems
Concealment Holsters
Concealment Accessories
Competition
Apparel
Sales Support
Index/Price List

Duty Holsters

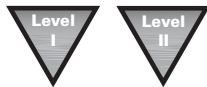

7390/7392/7395 7TS™ALS® LEVEL I RETENTION™ DUTY HOLSTERS FOR: PISTOLS

How to Order
Duty Holsters
Duty Accessories
Tactical Holsters
Tactical Accessories
Duty Belts
OAS
Speed Loaders
Light Systems
Concealment Holsters
Concealment Accessories
Competition
Apparel
Sales Support
Index/Price List

GUN DESCRIPTION	FINISH	COLOR	7390 MID-RIDE		7392 HI-RIDE		7395 LOW-RIDE	
			RIGHT	LEFT	RIGHT	LEFT	RIGHT	LEFT
Heckler & Koch USP 9C/40C DA/SA 4.25" BBL	SafariSeven Plain	Black	7390-391-411	7390-391-412	7392-391-411	7392-391-412	7395-391-411	7395-391-412
	SafariSeven Plain	FDE Brown	7390-391-551	7390-391-552	7392-391-551	7392-391-552	7395-391-551	7395-391-552
Heckler & Koch VP9 4.09" BBL	SafariSeven Plain	Black	7390-593-411	7390-593-412	7392-593-411	7392-593-412	7395-593-411	7395-593-412
	SafariSeven Plain	FDE Brown	7390-593-551	7390-593-552	7392-593-551	7392-593-552	7395-593-551	7395-593-552
Ruger American 9mm, .40, 4.5" BBL	SafariSeven Plain	Black	7390-167-411	7390-167-412	7392-167-411	7392-167-412	7395-167-411	7395-167-412
	SafariSeven Plain	FDE Brown	7390-167-551	7390-167-552	7392-167-551	7392-167-552	7395-167-551	7395-167-552
Ruger American .45 4.5" BBL	SafariSeven Plain	Black	7390-168-411	7390-168-412	7392-168-411	7392-168-412	7395-168-411	7395-168-412
	SafariSeven Plain	FDE Brown	7390-168-551	7390-168-552	7392-168-551	7392-168-552	7395-168-551	7395-168-552
Sig Sauer P226, P226R, P226R MK 9mm, .40 w/ITI M3, TLR-1, TLR-1HL, Surefire X200, X300, X300U, 4.41" BBL	SafariSeven Plain	Black	7390-4772-411	7390-4772-412	7392-4772-411	7392-4772-412	7395-4772-411	7395-4772-412
	SafariSeven Plain	FDE Brown	7390-4772-551	7390-4772-552	7392-4772-551	7392-4772-552	7395-4772-551	7395-4772-552
	SafariSeven Basket	Black	7390-4772-481	7390-4772-482	7392-4772-481	7392-4772-482	7395-4772-481	7395-4772-482
	SafariSeven Hi-Gloss	Black	7390-4772-491	7390-4772-492	7392-4772-491	7392-4772-492	7395-4772-491	7395-4772-492
Sig Sauer P220, P220R w/ Surefire X200, X300, X300U, 4.41" BBL	SafariSeven Plain	Black	7390-7702-411	7390-7702-412	7392-7702-411	7392-7702-412	7395-7702-411	7395-7702-412
	SafariSeven Plain	FDE Brown	7390-7702-551	7390-7702-552	7392-7702-551	7392-7702-552	7395-7702-551	7395-7702-552
	SafariSeven Basket	Black	7390-7702-481	7390-7702-482	7392-7702-481	7392-7702-482	7395-7702-481	7395-7702-482
	SafariSeven Hi-Gloss	Black	7390-7702-491	7390-7702-492	7392-7702-491	7392-7702-492	7395-7702-491	7395-7702-492
Sig Sauer P227, P227 R3 w/ ITI M3, TLR-1, TLR-1HL Surefire X200, X300, X300U, 3.9" BBL	SafariSeven Plain	Black	7390-6772-411	7390-6772-412	7392-6772-411	7392-6772-412	7395-6772-411	7395-6772-412
	SafariSeven Plain	FDE Brown	7390-6772-551	7390-6772-552	7392-6772-551	7392-6772-552	7395-6772-551	7395-6772-552
	SafariSeven Basket	Black	7390-6772-481	7390-6772-482	7392-6772-481	7392-6772-482	7395-6772-481	7395-6772-482
	SafariSeven Hi-Gloss	Black	7390-6772-491	7390-6772-492	7392-6772-491	7392-6772-492	7395-6772-491	7395-6772-492
Sig Sauer P229R DAK, P229R E2 9mm, 3.9" BBL	SafariSeven Plain	Black	7390-474-411	7390-474-412	7392-474-411	7392-474-412	7395-474-411	7395-474-412
	SafariSeven Plain	FDE Brown	7390-474-551	7390-474-552	7392-474-551	7392-474-552	7395-474-551	7395-474-552
Sig Sauer P229, P229DAK, P229R 9mm w/ITI M3, TLR-1, TLR-1HL, Surefire X200, X300, X300U 3.9" BBL	SafariSeven Plain	Black	7390-4742-411	7390-4742-412	7392-4742-411	7392-4742-412	7395-4742-411	7395-4742-412
	SafariSeven Plain	FDE Brown	7390-4742-551	7390-4742-552	7392-4742-551	7392-4742-552	7395-4742-551	7395-4742-552
	SafariSeven Basket	Black	7390-4742-481	7390-4742-482	7392-4742-481	7392-4742-482	7395-4742-481	7395-4742-482
	SafariSeven Hi-Gloss	Black	7390-4742-491	7390-4742-492	7392-4742-491	7392-4742-492	7395-4742-491	7395-4742-492
Sig Sauer P229, P229R, .40 3.9" BBL	SafariSeven Plain	Black	7390-447-411	7390-447-412	7392-447-411	7392-447-412	7395-447-411	7395-447-412
	SafariSeven Plain	FDE Brown	7390-447-551	7390-447-552	7392-447-551	7392-447-552	7395-447-551	7395-447-552
Sig Sauer P229, P229R .40 w/ ITI M3, TLR-1, TLR-1HL, Surefire X200, X300, X300U 3.9" BBL	SafariSeven Plain	Black	7390-4472-411	7390-4472-412	7392-4472-411	7392-4472-412	7395-4472-411	7395-4472-412
	SafariSeven Plain	FDE Brown	7390-4472-551	7390-4472-552	7392-4472-551	7392-4472-552	7395-4472-551	7395-4472-552
	SafariSeven Basket	Black	7390-4472-481	7390-4472-482	7392-4472-481	7392-4472-482	7395-4472-481	7395-4472-482
	SafariSeven Hi-Gloss	Black	7390-4472-491	7390-4472-492	7392-4472-491	7392-4472-492	7395-4472-491	7395-4472-492
Sig Sauer P220, P226, P220R, P226R, P226R MK25, 9mm, .40 4.41" BBL	SafariSeven Plain	Black	7390-477-411	7390-477-412	7392-477-411	7392-477-412	7395-477-411	7395-477-412
	SafariSeven Plain	FDE Brown	7390-477-551	7390-477-552	7392-477-551	7392-477-552	7395-477-551	7395-477-552
Sig Sauer P320 9mm, .40 4.7" BBL	SafariSeven Plain	Black	7390-450-411	7390-450-412	7392-450-411	7392-450-412	7395-450-411	7395-450-412
	SafariSeven Plain	FDE Brown	7390-450-551	7390-450-552	7392-450-551	7392-450-552	7395-450-551	7395-450-552
Sig Sauer P320 9mm, .40 w/ ITI M3, TLR-1, TLR-1HL Surefire X200/X300/ X300U, 4.7" BBL	SafariSeven Plain	Black	7390-4502-411	7390-4502-412	7392-4502-411	7392-4502-412	7395-4502-411	7395-4502-412
	SafariSeven Plain	FDE Brown	7390-4502-551	7390-4502-552	7392-4502-551	7392-4502-552	7395-4502-551	7395-4502-552
	SafariSeven Basket	Black	7390-4502-481	7390-4502-482	7392-4502-481	7392-4502-482	7395-4502-481	7395-4502-482
	SafariSeven Hi-Gloss	Black	7390-4502-491	7390-4502-492	7392-4502-491	7392-4502-492	7395-4502-491	7395-4502-492
Sig Sauer P320 Compact & Carry 9mm, .40 3.9" BBL	SafariSeven Plain	Black	7390-750-411	7390-750-412	7392-750-411	7392-750-412	7395-750-411	7395-750-412
	SafariSeven Plain	FDE Brown	7390-750-551	7390-750-552	7392-750-551	7392-750-552	7395-750-551	7395-750-552



Duty Holsters

7390/7392/7395 7TS™ALS® LEVEL I RETENTION™ DUTY HOLSTERS FOR: PISTOLS

GUN DESCRIPTION	FINISH	COLOR	7390 MID-RIDE		7392 HI-RIDE		7395 LOW-RIDE	
			RIGHT	LEFT	RIGHT	LEFT	RIGHT	LEFT
Sig Sauer P320 Compact & Carry 9mm, .40 w/ ITI M3, TLR-1, TLR-1HL Surefire X200/X300/X300U 4.7" BBL	SafariSeven Plain	Black	7390-7502-411	7390-7502-412	7392-7502-411	7392-7502-412	7395-7502-411	7395-7502-412
	SafariSeven Plain	FDE Brown	7390-7502-551	7390-7502-552	7392-7502-551	7392-7502-552	7395-7502-551	7395-7502-552
	SafariSeven Basket	Black	7390-7502-481	7390-7502-482	7392-7502-481	7392-7502-482	7395-7502-481	7395-7502-482
Sig Sauer P320 Full Size .45 3.9" BBL	SafariSeven Plain	Black	7390-451-411	7390-451-412	7392-451-411	7392-451-412	7395-451-411	7395-451-412
	SafariSeven Plain	FDE Brown	7390-451-551	7390-451-552	7392-451-551	7392-451-552	7395-451-551	7395-451-552
	SafariSeven Basket	Black	7390-451-481	7390-451-482	7392-451-481	7392-451-482	7395-451-481	7395-451-482
Sig Sauer P320 Full Size .45 w/ ITI M3, TLR-1, TLR-1HL Surefire X200/X300/ X300U, 3.9" BBL	SafariSeven Plain	Black	7390-4512-411	7390-4512-412	7392-4512-411	7392-4512-412	7395-4512-411	7395-4512-412
	SafariSeven Plain	FDE Brown	7390-4512-551	7390-4512-552	7392-4512-551	7392-4512-552	7395-4512-551	7395-4512-552
	SafariSeven Basket	Black	7390-4512-481	7390-4512-482	7392-4512-481	7392-4512-482	7395-4512-481	7395-4512-482
Sig Sauer P320 Compact & Carry .45, 3.9" BBL	SafariSeven Plain	Black	7390-751-411	7390-751-412	7392-751-411	7392-751-412	7395-751-411	7395-751-412
	SafariSeven Plain	FDE Brown	7390-751-551	7390-751-552	7392-751-551	7392-751-552	7395-751-551	7395-751-552
	SafariSeven Basket	Black	7390-751-481	7390-751-482	7392-751-481	7392-751-482	7395-751-481	7395-751-482
Sig Sauer P320 Compact & Carry .45 w/ ITI M3, TLR-1, TLR-1HL, Surefire X200/X300/X300U 3.9" BBL	SafariSeven Plain	Black	7390-7512-411	7390-7512-412	7392-7512-411	7392-7512-412	7395-7512-411	7395-7512-412
	SafariSeven Plain	FDE Brown	7390-7512-551	7390-7512-552	7392-7512-551	7392-7512-552	7395-7512-551	7395-7512-552
	SafariSeven Basket	Black	7390-7512-481	7390-7512-482	7392-7512-481	7392-7512-482	7395-7512-481	7395-7512-482
Smith & Wesson M&P 45 4.5" BBL	SafariSeven Plain	Black	7390-419-411	7390-419-412	7392-419-411	7392-419-412	7395-419-411	7395-419-412
	SafariSeven Plain	FDE Brown	7390-419-551	7390-419-552	7392-419-551	7392-419-552	7395-419-551	7395-419-552
	SafariSeven Basket	Black	7390-419-481	7390-419-482	7392-419-481	7392-419-482	7395-419-481	7395-419-482
Smith & Wesson M&P .45 w/ITI M3, TLR-1, TLR-1HL, Surefire X200, X300, X300U, 3.9" BBL	SafariSeven Plain	Black	7390-4192-411	7390-4192-412	7392-4192-411	7392-4192-412	7395-4192-411	7395-4192-412
	SafariSeven Plain	FDE Brown	7390-4192-551	7390-4192-552	7392-4192-551	7392-4192-552	7395-4192-551	7395-4192-552
	SafariSeven Basket	Black	7390-4192-481	7390-4192-482	7392-4192-481	7392-4192-482	7395-4192-481	7395-4192-482
Smith & Wesson M&P 9L, .40L 5" BBL	SafariSeven Plain	Black	7390-819-411	7390-819-412	7392-819-411	7392-819-412	7395-819-411	7395-819-412
	SafariSeven Plain	FDE Brown	7390-819-551	7390-819-552	7392-819-551	7392-819-552	7395-819-551	7395-819-552
	SafariSeven Basket	Black	7390-819-481	7390-819-482	7392-819-481	7392-819-482	7395-819-481	7395-819-482
Smith & Wesson M&P 9mm, .40 5" BBL	SafariSeven Plain	Black	7390-819-411	7390-819-412	7392-819-411	7392-819-412	7395-819-411	7395-819-412
	SafariSeven Plain	FDE Brown	7390-819-551	7390-819-552	7392-819-551	7392-819-552	7395-819-551	7395-819-552
	SafariSeven Basket	Black	7390-819-481	7390-819-482	7392-819-481	7392-819-482	7395-819-481	7395-819-482
Smith & Wesson M&P 9L, .40L w/ITI M3, TLR-1, TLR-1HL, Surefire X200, X300, X300U, 5" BBL	SafariSeven Plain	Black	7390-8192-411	7390-8192-412	7392-8192-411	7392-8192-412	7395-8192-411	7395-8192-412
	SafariSeven Plain	FDE Brown	7390-8192-551	7390-8192-552	7392-8192-551	7392-8192-552	7395-8192-551	7395-8192-552
	SafariSeven Basket	Black	7390-8192-481	7390-8192-482	7392-8192-481	7392-8192-482	7395-8192-481	7395-8192-482
Smith & Wesson M&P 9mm, .40 4" BBL	SafariSeven Plain	Black	7390-219-411	7390-219-412	7392-219-411	7392-219-412	7395-219-411	7395-219-412
	SafariSeven Plain	FDE Brown	7390-219-551	7390-219-552	7392-219-551	7392-219-552	7395-219-551	7395-219-552
	SafariSeven Basket	Black	7390-219-481	7390-219-482	7392-219-481	7392-219-482	7395-219-481	7395-219-482
Smith & Wesson M&P 9mm, .40 w/ XC-1 Surefire Light 4.25" BBL	SafariSeven Plain	Black	7390-21922-411	7390-21922-412	7392-21922-411	7392-21922-412	7395-21922-411	7395-21922-412
	SafariSeven Plain	FDE Brown	7390-21922-551	7390-21922-552	7392-21922-551	7392-21922-552	7395-21922-551	7395-21922-552
	SafariSeven Basket	Black	7390-21922-481	7390-21922-482	7392-21922-481	7392-21922-482	7395-21922-481	7395-21922-482
Smith & Wesson M&P 9/40 w/ ITI M3, TLR-1, TLR-1HL, SureFire X200/X300/X300U 4.25" BBL	SafariSeven Plain	Black	7390-2192-411	7390-2192-412	7392-2192-411	7392-2192-412	7395-2192-411	7395-2192-412
	SafariSeven Plain	FDE Brown	7390-2192-551	7390-2192-552	7392-2192-551	7392-2192-552	7395-2192-551	7395-2192-552
	SafariSeven Basket	Black	7390-2192-481	7390-2192-482	7392-2192-481	7392-2192-482	7395-2192-481	7395-2192-482
Smith & Wesson M&P 45C 4" BBL	SafariSeven Plain	Black	7390-919-411	7390-919-412	7392-919-411	7392-919-412	7395-919-411	7395-919-412
	SafariSeven Plain	FDE Brown	7390-919-551	7390-919-552	7392-919-551	7392-919-552	7395-919-551	7395-919-552
	SafariSeven Basket	Black	7390-919-481	7390-919-482	7392-919-481	7392-919-482	7395-919-481	7395-919-482
Walther P99Q 4" BBL	SafariSeven Plain	Black	7390-384-411	7390-384-412	7392-384-411	7392-384-412	7395-384-411	7395-384-412
	SafariSeven Plain	FDE Brown	7390-384-551	7390-384-552	7392-384-551	7392-384-552	7395-384-551	7395-384-552
Walther P99Q 5" BBL	SafariSeven Plain	Black	7390-385-411	7390-385-412	7392-385-411	7392-385-412	7395-385-411	7395-385-412
	SafariSeven Plain	FDE Brown	7390-385-551	7390-385-552	7392-385-551	7392-385-552	7395-385-551	7395-385-552

How to Order
Duty Holsters
Duty Accessories
Tactical Holsters
Tactical Accessories
Duty Belts
QAS
Speed Loaders
Light Systems
Concealment Holsters
Concealment Accessories
Competition
Apparel
Sales Support
Index/Price List

How to Order
Duty Holsters
Duty Accessories
Tactical Holsters
Tactical Accessories
Duty Belts
OAS
Speed Loaders
Light Systems
Concealment Holsters
Concealment Accessories
Competition
Apparel
Sales Support
Index/Price List

Duty Holsters



7520 EDW / 7TS™ SLS CLIP-ON STYLE LEVEL II RETENTION™ HOLSTERS: PISTOLS



PATENT PENDING

FEATURES

- ▶ Level II Retention™ holster
- ▶ SLS (Self Locking System) Rotating Hood
- ▶ Clip-on style belt loop with the ability to fit 1.5" (38mm), 1.75" (45mm), 2" (50mm) or 2.25" (58mm); belt loop is user-adjustable for cant angle
- ▶ Designed for cross draw carry
- ▶ Closed bottom with drain hole to protect cartridge and officer
- ▶ A proprietary nylon blend that is completely non-abrasive to a firearm's finish
- ▶ Very high heat and low cold tolerances structurally sound from 300 F to -50 F
- ▶ Available in SafariSeven™ finishes

GUN DESCRIPTION	FINISH	COLOR	RIGHT	LEFT
Taser® X26P	SafariSeven™	Plain	7520-364-411	7520-364-412
	SafariSeven™	Basket	7520-364-481	7520-364-482
	SafariSeven™	Hi-Gloss	7520-364-491	7520-364-492

Duty Holsters

7280/7360/7390 CAS™ - CAMERA ACTIVATION SYSTEM

FEATURES

Introducing the world's first holster and Camera Auto-activation System (CAS™). As an officer removes their firearm from the Safariland 7TS™ duty holster, the Camera Auto-activation System is triggered, activating a VIEVU® body worn camera. The camera begins recording, and includes the 30 seconds of footage prior to activation. The camera continues to record until stopped by the officer.

Available in Mid-Ride (7280, 7360, 7390) and Low-Ride versions (7285, 7365, 7395)

- ▶ 7360/7365 features ALS®/SLS retention; the ALS (Automatic Locking System) secures weapon once holstered; simple straight up draw once release is deactivated – Level III Retention™
- ▶ 7280/7285 includes SLS (Self Locking System) Rotating Hood retention – Level II Retention™
- ▶ 7390/7395 features ALS® retention; the ALS (Automatic Locking System) secures weapon once holstered; simple straight up draw once release is deactivated – Level I Retention™
- ▶ SafariSeven™ construction is a proprietary nylon blend that is completely non-abrasive to a firearm's finish
- ▶ Very high heat and low cold tolerances structurally sound from 300° F and -50° F



GUN DESCRIPTION	FINISH	COLOR	7280 MID-RIDE		7360 MID-RIDE		7390 MID-RIDE	
			RIGHT	LEFT	RIGHT	LEFT	RIGHT	LEFT
Glock 17/22 4.5" BBL	SafariSeven Plain	Black	7280CAS3-83-411	7280CAS3-83-412	7360CAS3-83-411	7360CAS3-83-412	7390CAS3-83-411	7390CAS3-83-412
	SafariSeven Basket	Black	7280CAS3-83-481	7280CAS3-83-482	7360CAS3-83-481	7360CAS3-83-482	7390CAS3-83-481	7390CAS3-83-482
Glock 17/22 Surefire X300U 4.5" BBL	SafariSeven Plain	Black	7280CAS3-832-411	7280CAS3-832-412	7360CAS3-832-411	7360CAS3-832-412	7390CAS3-832-411	7390CAS3-832-412
	SafariSeven Basket	Black	7280CAS3-832-481	7280CAS3-832-482	7360CAS3-832-481	7360CAS3-832-482	7390CAS3-832-481	7390CAS3-832-482
Glock 20/21 4.6" BBL	SafariSeven Plain	Black	7280CAS3-383-411	7280CAS3-383-412	7360CAS3-383-411	7360CAS3-383-412	7390CAS3-383-411	7390CAS3-383-412
	SafariSeven Basket	Black	7280CAS3-383-481	7280CAS3-383-482	7360CAS3-383-481	7360CAS3-383-482	7390CAS3-383-481	7390CAS3-383-482
Glock 20/21 Surefire X300U 4.6" BBL	SafariSeven Plain	Black	7280CAS3-3832-411	7280CAS3-3832-412	7360CAS3-3832-411	7360CAS3-3832-412	7390CAS3-3832-411	7390CAS3-3832-412
	SafariSeven Basket	Black	7280CAS3-3832-481	7280CAS3-3832-482	7360CAS3-3832-481	7360CAS3-3832-482	7390CAS3-3832-481	7390CAS3-3832-482
Smith & Wesson M&P 9mm, .40 4.25" BBL	SafariSeven Plain	Black	7280CAS3-219-411	7280CAS3-219-412	7360CAS3-219-411	7360CAS3-219-412	7390CAS3-219-411	7390CAS3-219-412
	SafariSeven Basket	Black	7280CAS3-219-481	7280CAS3-219-482	7360CAS3-219-481	7360CAS3-219-482	7390CAS3-219-481	7390CAS3-219-482
Smith & Wesson M&P 9mm, .40 Surefire X300U 4." BBL	SafariSeven Plain	Black	7280CAS3-2192-411	7280CAS3-2192-412	7360CAS3-2192-411	7360CAS3-2192-412	7390CAS3-2192-411	7390CAS3-2192-412
	SafariSeven Basket	Black	7280CAS3-2192-481	7280CAS3-2192-482	7360CAS3-2192-481	7360CAS3-2192-482	7390CAS3-2192-481	7390CAS3-2192-482
Sig Sauer P320 9mm, .40 4.7" BBL	SafariSeven Plain	Black	7280CAS3-450-411	7280CAS3-450-412	7360CAS3-450-411	7360CAS3-450-412	7390CAS3-450-411	7390CAS3-450-412
	SafariSeven Basket	Black	7280CAS3-450-481	7280CAS3-450-482	7360CAS3-450-481	7360CAS3-450-482	7390CAS3-450-481	7390CAS3-450-482
Sig Sauer P320 9mm, .40 Surefire X300U 4.7" BBL	SafariSeven Plain	Black	7280CAS3-4502-411	7280CAS3-4502-412	7360CAS3-4502-411	7360CAS3-4502-412	7390CAS3-4502-411	7390CAS3-4502-412
	SafariSeven Basket	Black	7280CAS3-4502-481	7280CAS3-4502-482	7360CAS3-4502-481	7360CAS3-4502-482	7390CAS3-4502-481	7390CAS3-4502-482
Sig Sauer P226R 9mm, .40 3.9" BBL	SafariSeven Plain	Black	7280CAS3-477-411	7280CAS3-477-412	7360CAS3-477-411	7360CAS3-477-412	7390CAS3-477-411	7390CAS3-477-412
	SafariSeven Basket	Black	7280CAS3-477-481	7280CAS3-477-482	7360CAS3-477-481	7360CAS3-477-482	7390CAS3-477-481	7390CAS3-477-482

***Note – To order Low-Ride Versions:**

Sample Part No.:
7285CAS3-XXX-XXX 7365CAS3-XXX-XXX 7395CAS-XXX-XXX

How to Order
Duty Holsters
Duty Accessories
Tactical Holsters
Tactical Accessories
Duty Belts
QAS
Speed Loaders
Light Systems
Concealment Holsters
Concealment Accessories
Competition
Apparel
Sales Support
Index/Price List

Duty Accessories

SLS/ALS® ACCESSORIES

How to Order
Duty Holsters
Duty Accessories
Tactical Holsters
Tactical Accessories
Duty Belts
OAS
Speed Loaders
Light Systems
Concealment Holsters
Concealment Accessories
Competition
Apparel
Sales Support
Index/Price List

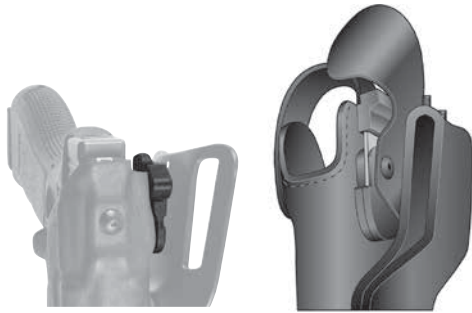

6006

6000

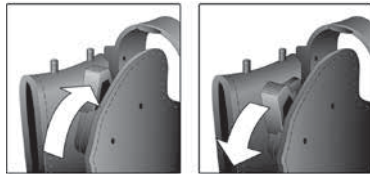

6001

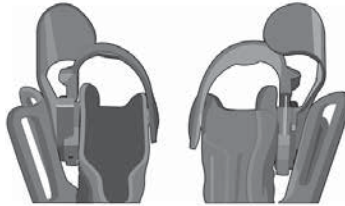

6002



ALS Guard – Unlocked

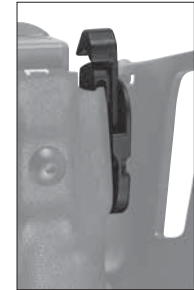

ALS Guard – Locked

MODEL	DESCRIPTION	RIGHT HAND	LEFT HAND
6000	Hood Guard	6000-1	6000-2
6001	Sentry	6001-1	6001-2
6002	Hood Guard & Sentry	6002-1	6002-2
6006	ALS Guard	6006-1-21	6006-1-22
6007	ALS Hood Guard	6007-21	6007-22
6008	Hood Guard & ALS Guard	6008-21	6008-22

BELT LOOP ACCESSORIES FOR 3-HOLE PATTERN

3 adjustable locations for strong side or crossdraw positions.



521-CAP



6281BL Shown w/ T-Spacer Kit



568BL Shown w/ T-Spacer Kit

MODEL	GUN DESCRIPTION
EDW ACCESSORY PLATES	
521-CAP-2	EDW Accessory Plate Plain Ambidextrous
521-CAP-26	EDW Accessory Plate Nylon Look Ambidextrous
521-CAP-8	EDW Accessory Plate Basket Ambidextrous
521-CAP-9	EDW Accessory Plate Hi Gloss Ambidextrous
REPLACEMENT BELT SLIDES	
295BL	Replacement Belt Loops Models 295/2955 Only
2955BL	Replacement Belt Loops Models 295/2955 Only
6281BL-261-150	Laminate Belt Loop Only, RH, 1.5" Belts
6281BL-262-150	Laminate Belt Loop Only, LH, 1.5" Belts
6281BL-261-175	Laminate Belt Loop Only, RH, 1.75" Belts
6281BL-262-175	Laminate Belt Loop Only, LH, 1.75" Belts
6281BL-261-225	Laminate Belt Loop Only, RH, 2.25" Belts
6281BL-262-225	Laminate Belt Loop Only, LH, 2.25" Belts
6280BL-2	Mid-Ride, Black Laminate Belt Loop Only
6280BL-13	Mid-Ride, STX Tactical Universal Belt Loop Only
6285BL-2	Low-Ride, Black Laminate Belt Loop Only, 1.5" Drop
6285BL-13	Low-Ride, STX Tactical Belt Loop Only, 1.5" Drop
5197BL	Mid-Ride Range Belt Loop, 1.5", 1.75" Belts
5195BL	Low-Ride Offset Range Belt Loop, 1.5", 1.75" Belts
REPLACEMENT PADDLES	
568BL-1-21	Injection Molded Paddle, RH
568BL-1-22	Injection Molded Paddle, LH
UNIVERSAL BELT LOOPS (UBL)	
6070UBL-2	Mid-Ride, Universal Belt Loop Only
6072UBL-2	Hi-Ride, Universal Belt Loop Only
6075UBL-2	Low-Ride, Universal Belt Loop 1.5" Drop
6070UBL-2-2	Mid-Ride, Universal Belt Loop w/ 2" Belt Width
6072UBL-2-2	Hi-Ride, Universal Belt Loop w/ 2" Belt Width
6075UBL-2-2	Low-Ride, Universal Belt Loop, 1.5" Drop w/ 2" Belt Width
6070UBL-PAD	Mid-Ride, UBL Pad
6075UBL-PAD	Low-Ride, UBL Pad
BELT LOOP INSERTS	
P-2200	Belt Loop Inserts for OBL
P-2201	Belt Loop Inserts for UBL
REPLACEMENT BELT LOOPS	
565BL	Injection Molded Hi-Ride Belt Loop, 1.5" or 1.75" Belt Widths
568BL	Hi-Ride Belt Loop (1" or 2" higher), 1.75" Belt Slots
567BL-1-2-150-175	Injection Molded Adjustable Belt Loop, 1.5" and 1.75" Belt Slots
567BL-1-2-150	Injection Molded Belt Loop, 1.5" Belt Slots
567BL-1-2-175	Injection Molded Belt Loop, 1.75" Belt Slots
567BL-1-2-50	Injection Molded Belt Loop, 2" Belt Slots
567BL-1-2-225	Injection Molded Belt Loop, 2.25" Belt Slots
567BL-2-150	Injection Molded Adjustable Belt Loop, 1.5", 1.75", 2" and 2.25" Belt Slots w/ 1" Drop
567BL-2-225	Injection Molded Adjustable Belt Loop, 2.25" Belt Slot w/ 1" Drop

Duty Accessories

BELT LOOP ACCESSORIES FOR 3-HOLE PATTERN

MODEL	GUN DESCRIPTION
HARDWARE KITS	
6281 HDA	HDA-2 Holster Drop Adapter (2" drop)
T-Spacer Pack	Two T-Spacers, Six Screws, Three Washers
HARDWARE KIT	Provides necessary materials: screws, rollers, washers, t-nuts, hook and Allen wrench to service a Safariland Holster.
HDA-KIT-RH	Spacer Kit with 6281HDA 2" Drop Adapter, Right Handed
HDA-KIT-LH	Spacer Kit with 6281HDA 2" Drop Adapter, Left Handed
CUSTOMIZE-KIT	Spacer Kit
Oval Spacer-Kit	Spacer Kit
REPLACEMENT BELT CLIPS	
744BL-2	Belt Clip for Accessories
745BL-2	Belt Clip for Holsters



6070UBL

HRA HIGH RIDE ADAPTER

- ▶ For use with Safariland 3-hole patterned holsters
- ▶ Lifts holster by 2"
- ▶ Available in Black

DESCRIPTION	COLOR	PART NO.
High Ride Adaptor	Black	HRA-1-2



35 BATON HOLDER

- ▶ Fits foam handle batons
- ▶ Three sizes for 16" (40.6cm), 21" (53.3cm) and 26" (66cm) batons

FINISH	COLOR	BATON LENGTH	PART NO.
Plain	Black	16" (41cm)	35-F16-2
Basket	Black	16" (41cm)	35-F16-4
Hi Gloss	Black	16" (41cm)	35-F16-9
STX Tactical	Black	16" (41cm)	35-F16-13
Plain	Black	21" (53cm)	35-F21-2
Basket	Black	21" (53cm)	35-F21-4
Hi Gloss	Black	21" (53cm)	35-F21-9
STX Tactical	Black	21" (53cm)	35-F21-13
Plain	Black	26" (66cm)	35-F26-2
Basket	Black	26" (66cm)	35-F26-4
Hi Gloss	Black	26" (66cm)	35-F26-9
STX Tactical	Black	26" (66cm)	35-F26-13

*Available in these additional colors:
 Sample Code 35-F26-41
 STX Plain 35-XX-41 Foliage Green 35-XX-54
 STX Basket 35-XX-48 Coyote Brown 35-XX-76
 STX Hi Gloss 35-XX-49 FDE Brown 35-XX-55
 Nylon Look 35-XX-22

Also available in tactical configuration, see page 139 for part information.



Duty Accessories

67 BATON RING, W/O SNAP/ 67S BATON RING W/SNAP



▶ Also fits C-cell flashlights

FINISH	COLOR	HARDWARE	PART NO. W/ SNAP	PART NO. W/O SNAP
Plain	Black	Chrome	67S-2	67-2
Plain	Black	Brass	67S-2B	67-2B
Plain	Black	Black	67S-2PBL	67-2PBL
Basket	Black	Chrome	67S-4	67-4
Basket	Black	Brass	67S-4B	67-4B
Basket	Black	Black	67S-4PBL	67-4PBL
Hi Gloss	Black	Chrome	67S-9	67-9
Hi Gloss	Black	Brass	67S-9B	67-9B
Hi Gloss	Black	Black	67S-9PBL	67-9PBL
Nylon Look	Black	Black	67S-22PBL	67-22PBL

135 BATON HOLDER



▶ Size F26 also fits the Streamlight® Stinger® flashlight

▶ Three sizes for 16" (40.6cm), 21" (53.3cm) and 26" (66cm) batons

FINISH*	COLOR	BATON LENGTH	RIGHT HAND	LEFT HAND
Plain	Black	16" (41cm)	135-F16-21**	135-F16-22**
Basket	Black	16" (41cm)	135-F16-41**	135-F16-42**
Hi Gloss	Black	16" (41cm)	135-F16-91**	135-F16-92**
STX Tactical	Black	16" (41cm)	135-F16-131 **	135-F16-132 **
Plain	Black	21" (53cm)	135-F21-21**	135-F21-22**
Basket	Black	21" (53cm)	135-F21-41**	135-F21-42**
Hi Gloss	Black	21" (53cm)	135-F21-91**	135-F21-92**
STX Tactical	Black	21" (53cm)	135-F21-131 **	135-F21-132 **
Plain	Black	26" (66cm)	135-F26-21**	135-F26-22**
Basket	Black	26" (66cm)	135-F26-41**	135-F26-42**
Hi Gloss	Black	26" (66cm)	135-F26-91**	135-F26-92**
STX Tactical	Black	26" (66cm)	135-F26-131**	135-F26-132**

** Available in 2 belt loop sizes. Add -150 for 1.5" (38mm), or -2 for 2.25" (58mm) belt loop to end of part numbers listed above.

*Available in these additional colors: Sample Code 135-F26-411

STX Plain 135-XX-411
 STX Basket 135-XX-481
 STX Hi Gloss 135-XX-491
 Nylon Look 135-XX-221
 FDE Brown 135-XX-551

692S BATON RING, W/SNAP



▶ Fits side-handle batons

FINISH	COLOR	HARDWARE	PART NO.
Plain	Black	Chrome	692S-2
Plain	Black	Brass	692S-2B
Plain	Black	Black	692S-2PBL
Basket	Black	Chrome	692S-4
Basket	Black	Brass	692S-4B
Basket	Black	Black	692S-4PBL
Hi Gloss	Black	Chrome	692S-9
Hi Gloss	Black	Brass	692S-9B
Hi Gloss	Black	Black	692S-9PBL
Nylon Look	Black	Black	692S-22PBL

Duty Accessories

62 BELT KEEPER, HIDDEN SNAP

- ▶ Available in a four pack, use part no. 62-4-X
- ▶ 1" (25mm) width

FINISH	COLOR	SNAP	PART NO.
Plain	Black	Hidden	62-2HS
Basket	Black	Hidden	62-4HS
Hi Gloss	Black	Hidden	62-9HS
Nylon Look	Black	Hidden	62-22HS



63 BELT KEEPER, SLOTTED

- ▶ Belt slot fits up to 1.75" (45mm) belt
- ▶ 2-snap
- ▶ 0.875" (22mm) width
- ▶ Available in 4-pack, use part no. 63-4-X

FINISH	COLOR	SNAP	PART NO. LAMINATED
Plain	Black	Chrome	63-2
Plain	Black	Brass	63-2B
Plain	Black	Hidden	63-2HS
Basket	Black	Chrome	63-4
Basket	Black	Brass	63-4B
Basket	Black	Hidden	63-4HS
Hi Gloss	Black	Chrome	63-9
Hi Gloss	Black	Brass	63-9B
Hi Gloss	Black	Hidden	63-9HS
Nylon Look	Black	Chrome	63-22
Nylon Look	Black	Brass	63-22PBL
Nylon Look	Black	Hidden	63-22HS

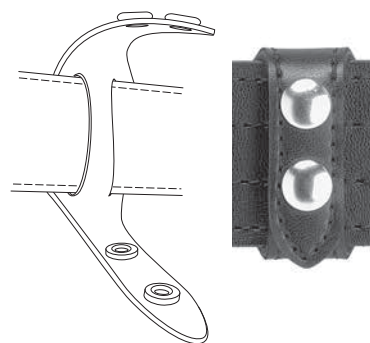

65 BELT KEEPER

- ▶ Available for 2" (50mm) belts: use part no. 65-X-50
- ▶ Available in 4-pack for 2" (50mm) belts: use part no. 65-4-X-50
- ▶ 2-snap
- ▶ 0.75" (19mm) width
- ▶ For STX Tactical use 65-2PBL

FINISH	COLOR	SNAP	PART NO.
Plain	Black	Chrome	65-2
Plain	Black	Chrome	65-4-2*
Plain	Black	Brass	65-2B
Plain	Black	Brass	65-4-2B*
Basket	Black	Chrome	65-4
Basket	Black	Chrome	65-4-4*
Basket	Black	Brass	65-4B
Basket	Black	Brass	65-4-4B*
Hi Gloss	Black	Chrome	65-9
Hi Gloss	Black	Chrome	65-4-9*
Hi Gloss	Black	Brass	65-9B
Hi Gloss	Black	Brass	65-4-9B*

*4-pack of keepers

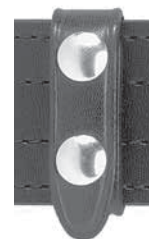

Duty Accessories

654 BELT KEEPER, SLOTTED, 4-SNAP



- ▶ Slots fit up to 1.75" (45mm) underbelts
- ▶ 2.125" (54mm) width

FINISH	COLOR	SNAP	PART NO.
Plain	Black	Chrome	654-2
Plain	Black	Brass	654-2B
Plain	Black	Black	654-2PBL
Basket	Black	Chrome	654-4
Basket	Black	Brass	654-4B
Basket	Black	Black	654-4PBL
Hi Gloss	Black	Chrome	654-9
Hi Gloss	Black	Brass	654-9B
Hi Gloss	Black	Black	654-9PBL
Nylon Look	Black	Chrome	654-22
Nylon Look	Black	Black	654-22PBL

655 BELT KEEPER, HEAVY DUTY



- ▶ 2-snap
- ▶ 1.25" (32mm) width

FINISH	COLOR	SNAP	PART NO.
Plain	Black	Chrome	655-2
Plain	Black	Brass	655-2B
Basket	Black	Chrome	655-4
Basket	Black	Brass	655-4B
Hi Gloss	Black	Chrome	655-9
Hi Gloss	Black	Brass	655-9B
Nylon Look	Black	Black	655-22PBL

Duty Accessories

HK-11 BELT KEEPER, HIDE-A-KEYPER™

► Belt keeper with hidden handcuff key

FINISH	COLOR	PART NO.
Plain	Black	HK-11-2
Basket	Black	HK-11-4
Hi Gloss	Black	HK-11-9



730 FLASHLIGHT RING, HEAVY DUTY, 2-SNAP

► 1 7/8" diameter ring

FINISH	COLOR	SNAP	PART NO.
Plain	Black	Chrome	730-2
Plain	Black	Brass	730-2B
Basket	Black	Chrome	730-4
Basket	Black	Brass	730-4B
Hi Gloss	Black	Chrome	730-9
Hi Gloss	Black	Brass	730-9B
Nylon Look	Black	Black	730-22PBL



168 KEY RING, 2-SNAP

► Flap-style

FINISH	COLOR	SNAP	PART NO.
Plain	Black	Chrome	168-2
Plain	Black	Brass	168-2B
Basket	Black	Chrome	168-4
Basket	Black	Brass	168-4B
Hi Gloss	Black	Chrome	168-9
Hi Gloss	Black	Brass	168-9B
Nylon Look	Black	Chrome	168-22
Nylon Look	Black	Black	168-22PBL



Does not include handcuff key

Duty Accessories

169S KEY RING, 1-SNAP



▶ Single snap attachment includes key ring

FINISH	COLOR	SNAP	PART NO.
Plain	Black	Chrome	169S-2
Plain	Black	Brass	169S-2B
Basket	Black	Chrome	169S-4
Basket	Black	Brass	169S-4B
Hi Gloss	Black	Chrome	169S-9
Hi Gloss	Black	Brass	169S-9B
Nylon Look	Black	Black	169S-22PBL

170 SILENT KEY HOLDER



▶ Hook & loop closure

FINISH	COLOR	SNAP	PART NO.
Plain	Black	Chrome	170-2
Plain	Black	Brass	170-2B
Basket	Black	Chrome	170-4
Basket	Black	Brass	170-4B
Hi Gloss	Black	Chrome	170-9
Hi Gloss	Black	Brass	170-9B
Nylon Look	Black	Black	170-22PBL

690 HANDCUFF STRAP, 1-SNAP



FINISH	COLOR	SNAP	PART NO.
Plain	Black	Chrome	690-2
Plain	Black	Brass	690-2B
Basket	Black	Chrome	690-4
Basket	Black	Brass	690-4B
Hi Gloss	Black	Chrome	690-9
Hi Gloss	Black	Brass	690-9B
Nylon Look	Black	Chrome	690-22
Nylon Look	Black	Brass	690-22B
Nylon Look	Black	Black	690-22PBL

HK-10 HANDCUFF KEY



FINISH	COLOR	PART NO.
Stainless Steel	1 Handcuff Key	HK-10
Stainless Steel	1 Dozen Handcuff Keys	HK-10-12
Stainless Steel	1 Gross Handcuff Keys	HK-10-144

Duty Accessories

306 OPEN TOP MINI-FLASHLIGHT HOLDER

FINISH	COLOR	PART NO.
Plain	Black	306-1-2*
Basket	Black	306-1-4*
Hi Gloss	Black	306-1-9*
STX Tactical	Black	306-1-13*
Plain	Black	306-2-2**
Basket	Black	306-2-4**
Hi Gloss	Black	306-2-9**
STX Tactical	Black	306-2-13**
Plain	Black	306-3-2***
Basket	Black	306-3-4***
Hi Gloss	Black	306-3-9***
STX Tactical	Black	306-3-13***
Plain	Black	306-6-2****
Basket	Black	306-6-4****
Hi Gloss	Black	306-6-9****
STX Tactical	Black	306-6-13****
Plain	Black	306-7-2#
Basket	Black	306-7-4#
Hi Gloss	Black	306-7-9#
STX Tactical	Black	306-7-13#
Plain	Black	306-11-2*****
Basket	Black	306-11-4*****
Hi Gloss	Black	306-11-9*****
STX Tactical	Black	306-11-13*****

- * Fits Streamlight® Stinger® flashlight
- ** Fits Streamlight® Scorpion™ flashlight
- *** Fits Laser SureFire 3 volt, 6P, 3R flashlights
- **** Fits Laser SureFire 6 volt, 9P, 6R, flashlights
- ***** Fits Streamlight® Stinger with Poly Grip, Stinger XT, Stinger LED
- # Fits Streamlight® Strion



*Available in these additional finishes:
 Sample Code 306-1-4I
 STX Plain 306-XX-4I
 STX Basket 306-XX-48
 STX Hi Gloss 306-XX-49
 Nylon Look 306-XX-22

DIMENSIONS:
 306-1: 1.12" Wide x 5.875" Length
 306-2: 1" Wide x 3.5625" Length
 306-3: 1" Wide x 3.9375" Length
 306-6: 1" Wide x 5.875" Length
 306-7: .95" Wide x 5" Length
 306-11: 1.25" Wide x 5.8125" Length

307 LIGHT/EDW CARTRIDGE HOLDER

FINISH	COLOR	PART NO.	PART NO. BRASS
Plain	Black	307-8-2*	307-8-2B*
Basket	Black	307-8-4*	307-8-4B*
Hi Gloss	Black	307-8-9*	307-8-9B*
STX Tactical	Black	307-8-13PBL*	N/A
Plain	Black	307-9-2**	307-9-2B**
Basket	Black	307-9-4**	307-9-4B**
Hi Gloss	Black	307-9-9**	307-9-9B**
STX Tactical	Black	307-9-13PBL**	N/A
Plain	Black	307-10-2***	307-10-2B***
Basket	Black	307-10-4***	307-10-4B***
Hi Gloss	Black	307-10-9***	307-10-9B***
STX Tactical	Black	307-10-13PBL***	N/A
Plain	Black	307-11-2****	307-11-2B****
Basket	Black	307-11-4****	307-11-4B****
Hi Gloss	Black	307-11-9****	307-11-9B****
STX Tactical	Black	307-11-13PBL****	N/A
Plain	Black	307-12-2*****	307-12-2B*****
Basket	Black	307-12-4*****	307-12-4B*****
Hi Gloss	Black	307-12-9*****	307-12-9B*****
STX Tactical	Black	307-12-13PBL*****	N/A
Plain	Black	307-13-2#	307-13-2B#
Basket	Black	307-13-4#	307-13-4B#
Hi Gloss	Black	307-13-9#	307-13-9B#
STX Tactical	Black	307-13-13PBL#	N/A

All STX Tactical Finishes are standard with a tone on tone snap

- * ITI M3, M5 and Streamlight TLR-1 light
- ** Taser® Cartridge
- *** Fits Glock Light System, Glock GTL 10 Light Only, Glock GTL 21 Light/Laser Combination, Glock GTL 22 Light/Laser Combination
- **** Insight Technology M6X
- ***** ITI M3X, M6 Illuminator Light or Streamlight TLR-2
- # SureFire X200/X300, LAS/TAC 2 Light Only N/A w/ Adapter



*Available in these additional finishes:
 Sample Code 307-8-4I
 STX Plain 307-XX-4I
 STX Basket 307-XX-48
 STX Hi Gloss 307-XX-49
 Nylon Look 307-XX-22PBL

DIMENSIONS:
 307-8: 1.625" Wide x 2.75" High x 1.5" Deep
 307-9: 1.875" Wide x 2" High x 1.25" Deep
 307-10: 2" Wide x 3" High x 1.25" Deep
 307-11: 3" Wide x 3" High x 1.5" Deep
 307-12: 1.625" Wide x 3" High x 1.625" Deep
 307-13: 1.5" Wide x 3.125" High x 1.375" Deep

How to Order
 Duty Holsters
 Duty Accessories
 Tactical Holsters
 Tactical Accessories
 Duty Belts
 QAS
 Speed Loaders
 Light Systems
 Concealment Holsters
 Concealment Accessories
 Competition
 Apparel
 Sales Support
 Index/Price List

Duty Accessories

308 TOP MINI-FLASHLIGHT HOLDER



- ▶ Fits selected hand-held lights
- ▶ Dimensions: 308-4: 1" Wide x 4.8125" Length

FINISH	COLOR	SNAP	PART NO.
Plain	Black	Chrome	308-4-2*
Plain	Black	Brass	308-4-2B*
Basket	Black	Chrome	308-4-4*
Basket	Black	Brass	308-4-4B*
Hi Gloss	Black	Chrome	308-4-9*
Hi Gloss	Black	Brass	308-4-9B*
STX Plain	Black	Chrome	308-4-41
STX Basket	Black	Chrome	308-4-48
STX Tactical	Black	Black	308-4-13PBL*
STX Hi Gloss	Black	Chrome	308-4-49

* Model 308 fits INOVAT3 flashlight.

Also available in tactical configuration, see page 165 for part information.

090/090H OPEN TOP HANDCUFF CASE



- ▶ Model 090H fits standard sized hinged handcuffs
- ▶ Model 090 fits standard sized chain handcuffs
- ▶ Hinged model has snap-on belt loop

FINISH	COLOR	PART NO. CHAIN	PART NO. HINGED
Plain	Black	090-16	090H-16
Basket	Black	090-18	090H-18
Hi Gloss	Black	090-9	090H-9
Nylon Look	Black	090-22	090H-22

090-1 OPEN TOP HANDCUFF CASE



- ▶ Fits standard or oversized handcuffs

FINISH	COLOR	PART NO.
Plain	Black	090-1-16
Basket	Black	090-1-18
Hi Gloss	Black	090-1-9
Nylon Look	Black	090-1-22

Duty Accessories

90/90H HANDCUFF CASE

- ▶ Model 90 also available in 1.75" (45mm) belt loop, use part no. 90-45
- ▶ Fits standard chain or hinge style handcuffs

FINISH	COLOR	SNAP	PART NO. CHAIN	PART NO. HINGED
Plain	Black	Chrome	90-2	90H-2
Plain	Black	Brass	90-2B	90H-2B
Plain	Black	Hidden Snap	90-2HS	90H-2HS
Basket	Black	Chrome	90-4	90H-4
Basket	Black	Brass	90-4B	90H-4B
Basket	Black	Hidden Snap	90-4HS	90H-4HS
Hi Gloss	Black	Chrome	90-9	90H-9
Hi Gloss	Black	Brass	90-9B	90H-9B
Hi Gloss	Black	Hidden Snap	90-9HS	90H-9HS
Nylon Look	Black	Chrome	90-22	90H-22
Nylon Look	Black	Brass	90-22B	90H-22B
Nylon Look	Black	Hidden Snap	90-22HS	90H-22HS
Plain	Black	Chrome	N/A	90H-1-2**
Basket	Black	Chrome	N/A	90H-1-4**
Hi Gloss	Black	Chrome	N/A	90H-1-9**

**Peerless 801 handcuffs



190/190H HANDCUFF CASE

- ▶ Fits standard chain or hinged handcuffs

FINISH	COLOR	SNAP	PART NO. CHAIN	PART NO. HINGED
Plain	Black	Chrome	190-2	190H-2
Plain	Black	Brass	190-2B	190H-2B
Plain	Black	Hidden Snap	190-2HS	190H-2HS
Basket	Black	Chrome	190-4	190H-4
Basket	Black	Brass	190-4B	190H-4B
Basket	Black	Hidden Snap	190-4HS	190H-4HS
Hi Gloss	Black	Chrome	190-9	190H-9
Hi Gloss	Black	Brass	190-9B	190H-9B
Hi Gloss	Black	Hidden Snap	190-9HS	190H-9HS
STX Tactical	Black	Black	190-13PBL	190H-13PBL
STX Tactical	Black	Hidden Snap	190-13HS	190H-13HS
Plain	Black	Chrome	190-2-2**	N/A
Plain	Black	Brass	190-2-2B**	N/A
Plain	Black	Hidden Snap	190-2-2HS**	N/A
Basket	Black	Chrome	190-2-4**	N/A
Basket	Black	Brass	190-2-4B**	N/A
Basket	Black	Hidden Snap	190-2-4HS**	N/A
Hi Gloss	Black	Chrome	190-2-9**	N/A
Hi Gloss	Black	Brass	190-2-9B**	N/A
Hi Gloss	Black	Hidden Snap	190-2-9HS**	N/A
STX Tactical	Black	Black	190-2-13-PBL**	N/A
STX Tactical	Black	Hidden Snap	190-2-13HS**	N/A

**ASP Model 100, Peerless Model 801 and Smith & Wesson Model 01 (chain or hinged style)

Available in a tactical configuration, see page 142 for part information.



*Available in these Additional Colors & Finishes:

STX Plain	Sample Code 190-41PBL
STX Basket	Sample Code 190-48PBL
STX Hi Gloss	Sample Code 190-49PBL
Foliage Green	Sample Code 190-54PBL
Coyote	Sample Code 190-76PBL
Nylon Look	Sample Code 190-22PBL

Duty Accessories

290 DOUBLE HANDCUFF CASE



- ▶ 1-snap
- ▶ Fits standard chain style handcuffs or 1 handcuff with surgical gloves

FINISH	COLOR	SNAP	PART NO. CHAIN
Plain	Black	Chrome	290-2
Plain	Black	Brass	290-2B
Plain	Black	Hidden Snap	290-2HS
Basket	Black	Chrome	290-4
Basket	Black	Brass	290-4B
Basket	Black	Hidden Snap	290-4HS
Hi Gloss	Black	Chrome	290-9
Hi Gloss	Black	Brass	290-9B
Hi Gloss	Black	Hidden Snap	290-9HS
Nylon Look	Black	Chrome	290-22
Nylon Look	Black	Black	290-22PBL
Nylon Look	Black	Hidden Snap	290-22HS

290H DOUBLE HANDCUFF CASE



FINISH	COLOR	SNAP	PART NO. HINGED
Plain	Black	Chrome	290H-1-2*
Plain	Black	Brass	290H-1-2B*
Basket	Black	Chrome	290H-1-4*
Basket	Black	Brass	290H-1-4B*
Hi Gloss	Black	Chrome	290H-1-9*
Hi Gloss	Black	Brass	290H-1-9B*
Nylon Look	Black	Black	290H-1-22PBL

*Fits Peerless Model 801 hinged handcuffs

33 SURGICAL GLOVE HOLDER

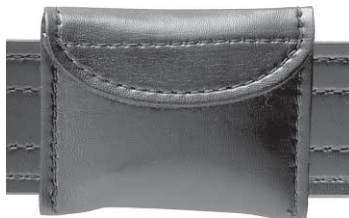

- ▶ Holds one pair latex gloves
- ▶ Dimensions: 3.25" (83mm) Long x 4" (102mm) Wide x 1" (25mm) High

FINISH	COLOR	CLOSURE	PART NO.
Plain	Black	Hook and Loop	33-2V
Plain	Black	Hook and Loop	33-3*-2V
Basket	Black	Hook and Loop	33-4V
Basket	Black	Hook and Loop	33-3*-4V
Hi Gloss	Black	Hook and Loop	33-9V
Hi Gloss	Black	Hook and Loop	33-3*-9V
Nylon Look	Black	Hook and Loop	33-22V
Nylon Look	Black	Hook and Loop	33-3-22V

*Part numbers beginning with 33-3- hold 3-pair latex gloves

Duty Accessories

761 ADJUSTABLE RADIO HOLDER

FINISH	COLOR	PART NO.
Plain	Black	761-X-2*
Basket	Black	761-X-4*
Hi Gloss	Black	761-X-9*
STX Tactical	Black	761-X-13*
STX Plain	Black	761-X-41*
STX Basket	Black	761-X-48*
STX Hi Gloss	Black	761-X-49*
Nylon Look	Black	761-X-22*

*Available in six pouch sizes. To order, replace the X with the proper size code (shown below)

- 1 - 1.75" (45mm) Deep x 2.875" (73mm) Wide x 4.75" (121mm) High
- 2 - 1.75" (45mm) Deep x 2.875" (73mm) Wide x 3.75" (95mm) High
- 3 - 1.5" (38mm) Deep x 3.00" (76mm) Wide x 4.75" (121mm) High
- 4 - 2" (50mm) Deep x 2.875" (73mm) Wide x 3.75" (95mm) High
- 5 - 1.625" (41mm) Deep x 2.25" (60mm) Wide x 3.5" (89mm) High
- 6 - 1.25" (32mm) Deep x 3.00" (76mm) Wide x 4.5" (118mm) High
- 8 - 1.65" (42mm) Deep x 2.25" (57mm) Wide x 4.5" (118mm) High



762 RADIO HOLDER W/SWIVEL

FINISH	COLOR	PART NO.
Plain	Black	762-X-2*
Basket	Black	762-X-4*
Hi Gloss	Black	762-X-9*
STX Tactical	Black	762-X-13*
STX Plain	Black	762-X-41*
STX Basket	Black	762-X-48*
STX Hi Gloss	Black	762-X-49*
Nylon Look	Black	762-X-22*

- ▶ Detachable swivel belt loop for easy retrieval
- ▶ Adjustable bungie cord tie-down cord with a snap closure
- ▶ Durable SafariLaminate™ construction

*Available in five pouch sizes. To order, replace the X with the proper size code (shown below).

- 3 - 1.5" (38mm) Deep x 3.00" (76mm) Wide x 4.75" (121mm) High
- 5 - 1.625" (41mm) Deep x 2.25" (60mm) Wide x 3.5" (89mm) High
- 6 - 1.25" (32mm) Deep x 3.00" (75mm) Wide x 4.5" (118mm) High
- 7 - 3.125" (79mm) Deep x 3.375" (86mm) Wide x 6.375" (162mm) High
- 8 - 1.65" (41mm) Deep x 2.25" (60mm) Wide x 6.25" (159mm) High



763 UNIVERSAL RADIO HOLDER

- ▶ The universal-fit rugged SafariLaminate™ radio case features an adjustable band to fit almost any standard portable police
- ▶ Bottom lip retains the radio from falling through

FINISH	COLOR	PART NO.
Plain	Black	763-2
Basket	Black	763-4
Hi Gloss	Black	763-9
Nylon Look	Black	763-22



How to Order
Duty Holsters
Duty Accessories
Tactical Holsters
Tactical Accessories
Duty Belts
OAS
Speed Loaders
Light Systems
Concealment Holsters
Concealment Accessories
Competition
Apparel
Sales Support
Index/Price List

Duty Accessories

764 ADJUSTABLE TAPE RECORDER HOLDER



FINISH	COLOR	PART NO.
Plain	Black	764-1-2
Basket	Black	764-1-4
Hi Gloss	Black	764-1-9
STX Plain	Black	764-1-41
STX Hi Gloss	Black	764-1-49
STX Tactical	Black	764-1-13
STX Basket	Black	764-1-48

Dimensions: 1.125" (29mm) Deep x 2.25" (58mm) Wide x 5.5" (139mm) High

766 RADIO HOLDER



- ▶ Protective pouch and adjustable bungee cord tie-down with snap closure
- ▶ Utilizes 745BL Belt Attachment, giving users the ability to clip on or off of the belt without removing other accessories
- ▶ Fits belt widths from 1.5" (38mm) to 2.25" (58mm)

FINISH	COLOR	PART NO.
STX Tactical	Black	766-X-13*
STX Plain	Black	766-X-41*
STX Basket	Black	766-X-48*
STX Hi Gloss	Black	766-X-49*

*To order, replace the X with the proper size code (shown below)

Dimensions: 8 - 1.75" (45mm) Deep x 2.875" (73mm) Wide x 4.75" (121mm) High

34 OPEN TOP OC HOLDER



- ▶ Made specifically to hold the Defense Technology® OC Instantaneous Blast Grenade
- ▶ Open-top design for quick retrieval yet sturdy product retention
- ▶ Features the 745BL belt clip, fits belt widths from 1.5" (38mm) to 2.25" (58mm); belt clip is user adjustable for cant angle
- ▶ Available in a tactical configuration

FINISH	COLOR	PART NO.
STX Tactical	Black	34-4-13
STX Plain	Black	34-4-41
STX Basket	Black	34-4-48
STX Hi Gloss	Black	34-4-49
STX Tactical	Foliage Green	34-4-54
STX Tactical	Coyote	34-4-76
STX Tactical	OD Green	34-4-56
STX Tactical	FDE Brown	34-4-55

Duty Accessories

36 OPEN TOP OC HOLDER

- ▶ Made specifically to hold the Defense Technology® MK-9 series of aerosols
- ▶ Open-top design for quick retrieval yet sturdy product retention
- ▶ Features the 745BL belt clip, fits belt widths from 1.5" (38mm) to 2.25" (58mm); belt clip is user adjustable for cant angle
- ▶ Available in a tactical configuration

FINISH	COLOR	RIGHT HAND	LEFT HAND
STX Tactical	Black	36-8-131	36-8-132
STX Plain	Black	36-8-411	36-8-412
STX Basket	Black	36-8-481	36-8-482
STX Hi Gloss	Black	36-8-491	36-8-492
STX Tactical	Foliage Green	36-8-541	36-8-542
STX Tactical	Coyote	36-8-761	36-8-762
STX Tactical	OD Green	36-8-561	36-8-562
STX Tactical	FDE Brown	36-8-551	36-8-552



37 OPEN TOP MACE®/OC SPRAY HOLDER

FINISH	COLOR	PART NO.
Plain	Black	37-2
Basket	Black	37-4
Hi Gloss	Black	37-9
STX Plain	Black	37-41
STX Basket	Black	37-48
STX Hi Gloss	Black	37-49
STX Tactical	Black	37-13
Nylon Look	Black	37-22

Dimensions: 1.5" (38mm) (diameter) x 5.5" - 6.5" (13.9cm - 16.51cm) (high).
Fits: Fits: Guardian 4 oz., Defense Technology® MK-4 3 oz., Freeze 4 oz., and Punch II M-4 4 oz. canisters.

Plain	Black	37-3-2
Basket	Black	37-3-4
Hi Gloss	Black	37-3-9
STX Plain	Black	37-3-41
STX Basket	Black	37-3-48
STX Hi Gloss	Black	37-3-49
STX Tactical	Black	37-3-13
Nylon Look	Black	37-3-22

Dimensions: 1.375" (34.9mm) (diameter) x 5" (12.7cm) (high).
Fits: Guardian 2 oz. & 3 oz., Defense Technology® MK-6 .68 oz., Freeze 2 oz., and Punch II M-3 2 oz. canisters.

Plain	Black	37-4-2
Basket	Black	37-4-4
Hi Gloss	Black	37-4-9
STX Plain	Black	37-4-41
STX Basket	Black	37-4-48
STX Hi Gloss	Black	37-4-49
STX Tactical	Black	37-4-13
Nylon Look	Black	37-4-22

Dimensions: 1.5" (38mm) (diameter) x 4" - 4.5" (10.16cm - 11.43cm) (high).
Fits: Defense Technology® MK-3 1.47 oz., and 2 oz. canisters. MSI MKIII OC/CS 2 oz. and Pepper Mace MK-3 5.5% 2 oz. canisters.

Plain	Black	37-8-2
Basket	Black	37-8-4
Hi Gloss	Black	37-8-9
STX Plain	Black	37-8-41
STX Basket	Black	37-8-48
STX Hi Gloss	Black	37-8-49
STX Tactical	Black	37-8-13
Nylon Look	Black	37-8-22

Dimensions: 2.5" (64mm) (diameter) x 3.5" (8.9cm) (high)
Fits: eXact iMpack™ 1006 40mm. Direct Impact® OC 40mm.
Can be ordered for 2.25" (58mm) belt slide, or as a mount on leg and vest accessory.



Available in a tactical configuration, see page 139 for part information.

Duty Accessories

38, 38HS TOP MACE®/OC SPRAY HOLDER



FINISH*	COLOR	CLOSURE	PART NO.
Plain	Black	Snap	38-2
Plain	Black	Hidden Snap	38-2HS
Basketweave	Black	Snap	38-4
Basketweave	Black	Hidden Snap	38-4HS
Hi Gloss	Black	Snap	38-9
Hi Gloss	Black	Hidden Snap	38-9HS
STX Tactical	Black	Snap	38-13PBL

Dimensions: 1.5" (38mm) x 6.5" (165.1mm)

Fits: MK-2 Defense Technology®, Guardian 4 oz., Freeze 4 oz., Punch II M-4 4oz., 43423-BGLE Fogger 4.0 oz., 42423-BG Fogger 4.0 oz., 43435-BGLE10 CT Stream 4.0 oz., 43434 BGLE10 CT Cone 4.0 oz., 43432-BGLE10 CT Foam 4.0 oz., 42434-BG CT Cone 4.0 oz., 43445-BGLE10 QT Stream 4.0 oz., 43444-BGLE10 QT Cone 4.0 oz., 43442-BGLE10 QT Foam 4.0 oz., 42444-BG QT Cone 4.0 oz., 45444 Hi Power QT Cone 4.0 oz.

Plain	Black	Snap	38-2-2
Plain	Black	Hidden Snap	38-2-2HS
Basketweave	Black	Snap	38-2-4
Basketweave	Black	Hidden Snap	38-2-4HS
Hi Gloss	Black	Snap	38-2-9
Hi Gloss	Black	Hidden Snap	38-2-9HS
STX Tactical	Black	Snap	38-2-13PBL

Dimensions: 1.375" (34.9mm) x 4" (101.6mm)

Fits: MK-4, Guardian 2 oz., Freeze 2 oz., and Punch II M-3 2 oz. canisters

Plain	Black	Snap	38-3-2
Plain	Black	Hidden Snap	38-3-2HS
Basketweave	Black	Snap	38-3-4
Basketweave	Black	Hidden Snap	38-3-4HS
Hi Gloss	Black	Snap	38-3-9
Hi Gloss	Black	Hidden Snap	38-3-9HS
STX Tactical	Black	Snap	38-3-13PBL

Dimensions: 1.375" (34.9mm) x 5" (127mm)

Fits: Defense Technology® MK-6 .68 oz., Guardian 2 oz. & 3 oz., Freeze 2 oz., canisters, 43223-BGLE 10 Fogger 3.0 oz., 42223-BG Fogger 3.0 oz., 43245-BGLE 10 QT Stream 3.0 oz., 43244-BGLE 10 QT Cone 3.0 oz., 43242-BGLE 10 QT Foam 3.0 oz., 42244-BG QT Cone 3.0 oz., 45244-Hi Power QT Cone 3.0 oz., 43235-BGLE 10 CT Stream 3.0 oz., 43234-BGLE 10 CT Cone 3.0 oz., 43232-BGLE 10 CT Foam 3.0 oz., 42234-BG Home Cone 3.0 oz., 46235-911 CT Stream 3.0 oz.

Plain	Black	Snap	38-4-2
Plain	Black	Hidden Snap	38-4-2HS
Basketweave	Black	Snap	38-4-4
Basketweave	Black	Hidden Snap	38-4-4HS
Hi Gloss	Black	Snap	38-4-9
Hi Gloss	Black	Hidden Snap	38-4-9HS
STX Tactical	Black	Snap	38-4-13PBL

Dimensions: 1.5" (38mm) x 4.5" (101.6mm)

Fits: MK-3 Defense Technology®,

Plain	Black	Snap	38-5-2
Plain	Black	Hidden Snap	38-5-2HS
Basketweave	Black	Snap	38-5-4
Basketweave	Black	Hidden Snap	38-5-4HS
Hi Gloss	Black	Snap	38-5-9
Hi Gloss	Black	Hidden Snap	38-5-9HS
STX Tactical	Black	Snap	38-5-13PBL

Dimensions: 2.38" (60.45mm) x 8.5" (215.9mm)

Fits: Capstrum Z-305

Plain	Black	Snap	38-6-2
Plain	Black	Hidden Snap	38-6-2HS
Basketweave	Black	Snap	38-6-4
Basketweave	Black	Hidden Snap	38-6-4HS
Hi Gloss	Black	Snap	38-6-9
Hi Gloss	Black	Hidden Snap	38-6-9HS
STX Tactical	Black	Snap	38-6-13PBL

Dimensions: 5" (127mm) x 5.5" (139.7mm)

Fits: Defense Technology® First Defense® MK-9 Magnum

Duty Accessories

38, 38HS OPEN TOP MACE®/OC SPRAY HOLDER (continued)

FINISH *	COLOR	CLOSURE	PART NO.
Plain	Black	Snap	38-7-2
Plain	Black	Hidden Snap	38-7-2HS
Basketweave	Black	Snap	38-7-4
Basketweave	Black	Hidden Snap	38-7-4HS
Hi Gloss	Black	Snap	38-7-9
Hi Gloss	Black	Hidden Snap	38-7-9HS
STX Tactical	Black	Snap	38-7-13PBL

Dimensions: 0.625" (15.88mm) x 5.5" (139.7mm)
Fits: ASP Key Defender

Plain	Black	Snap	38-8-2
Plain	Black	Hidden Snap	38-8-2HS
Basketweave	Black	Snap	38-8-4
Basketweave	Black	Hidden Snap	38-8-4HS
Hi Gloss	Black	Snap	38-8-9
Hi Gloss	Black	Hidden Snap	38-8-9HS
STX Tactical	Black	Snap	38-8-13PBL

Dimensions: 2.5" (63.5mm) x 10" (254mm)
Fits: eXact iImpact™ 1006 40mm, Direct Impact® OC 40mm

Plain	Black	Snap	38-9-2
Plain	Black	Hidden Snap	38-9-2HS
Basketweave	Black	Snap	38-9-4
Basketweave	Black	Hidden Snap	38-9-4HS
Hi Gloss	Black	Snap	38-9-9
Hi Gloss	Black	Hidden Snap	38-9-9HS
STX Tactical	Black	Snap	38-9-13PBL

Fits: Saber MK-9

Available in a tactical configuration, see page 139 for part information.

- ▶ Model 38 is available with a chrome, brass, or hidden snap. Use the above snap part numbers for chrome snap or hidden snap. For brass snap, add a B at the end of the part number, e.g. 38-3-2B.

*Available in these Additional Colors & Finishes:
Sample Code 38-3-41PBL

Nylon Look	38-X-22PBL	STX Basket	38-X-48PBL
Foliage Green	38-X-54PBL	STX Hi Gloss	38-X-49PBL
Coyote Brown	38-X-76PBL	FDE Brown	38-X-55PBL
STX Plain	38-X-41PBL		

How to Order
Duty Holsters
Duty Accessories
Tactical Holsters
Tactical Accessories
Duty Bats
QAS
Speed Loaders
Light Systems
Concealment Holsters
Concealment Accessories
Competition
Apparel
Sales Support
Index/Price List

Duty Accessories

72 DOUBLE MAGAZINE AND CUFF POUCH



FEATURES

- ▶ Adjustable angle positions designed into belt loop for both vertical and horizontal carry
- ▶ Designed to carry two handgun magazines and one pair of handcuffs
- ▶ Adjustable tension device to help retain magazines in pouch
- ▶ SafariLaminate™ construction

GUN DESCRIPTION	FINISH	COLOR	PART NO.
Beretta 8000, 8040, 92 Brigadier, 92D, 92DS, 92F, 92FC, 92FCDA, 92FS, 92FS Centurion, 92G, 96, 96 Brigadier, 96D, 96DC, 96DS, 96G, 96 Centurion	Plain Basket Hi Gloss	Black Black Black	72-76-2 72-76-4 72-76-9
Browning BDM 9mm			
Heckler & Koch P7M13			
Ruger KP-89, KP-89 DAO, KP-89 DAOW, KP-89 DC, KP-89 DW, KP-89 W, KP-91 DC, KP-91 DAO, KP-95 D, KP-95 DAO, KP-944, KP-944 DAO, KP-944 DAOW, KP-944 DC, KP-944 DW, KP-944 W, P-85, P-89, P-89 DC, P-89 DW, P-89 W, P-91 DC, P-91 DAO, P-93, P-94, P-95 D, P-95 DAO			
Sig Sauer P226, P228, P229, P226R MK25			
Smith & Wesson 59, 459, 469, 659, 669, 910, 915, 4006, 4013TSW, 4026, 4053TSW, 5903, 5904, 5906, 5923, 5924, 5926, 5946, 6904, 6906, 6924, 6926, 6946, M&P 9mm, .40			
Springfield Armory XD 9mm, .40			
Taurus PT-92, PT-92C, PT-99, PT-99C, PT-101			
Glock 17, 22, 31, 34, 35	Plain Basket Hi Gloss	Black Black Black	72-83-2 72-83-4 72-83-9
Heckler & Koch USP 9C, 40C			
Sig Sauer SP2340			
Smith & Wesson Sigma 9C, 40C, 9E, 9mm, 40F, SW9V, SW40V, SW99			
Smith & Wesson M&P 9mm, .40			
Glock 20, 21	Plain Basket Hi Gloss	Black Black Black	72-383-2 72-383-4 72-383-9

Duty Accessories

73 DOUBLE DUTY OPEN TOP MAGAZINE POUCH

How to Order
Duty Holsters
Duty Accessories
Tactical Holsters
Tactical Accessories
Duty Belts
OAS
Speed Loaders
Light Systems
Concealment Holsters
Concealment Accessories
Competition
Apparel
Sales Support
Index/Price List

FEATURES

- ▶ Features adjustable angle positions for both vertical and horizontal carry
- ▶ Low cut design and space between pouches for quick magazine retrieval
- ▶ Tension screw allows retention adjustment
- ▶ SafariLaminate™ construction



GUN DESCRIPTION	FINISH	COLOR	PART NO.
Beretta 8000, 8040, 92 Brigadier, 92D, 92DS, 92F, 92FC, 92FCDA, 92FS, 92FS Centurion, 92G, 96, 96 Brigadier, 96D, 96DC, 96DS, 96G, 96 Centurion, 90-Two	Plain Basket Hi Gloss STX Plain STX Basket STX Hi Gloss STX Tactical	Black Black Black Black Black Black Black	73-76-2 73-76-4 73-76-9 73-76-41 73-76-48 73-76-49 73-76-13
Browning BDM 9mm			
Heckler & Koch P7M13, P2000			
Ruger KP-89, KP-89 DAO, KP-89 DC, KP-89 DW, KP-89 W, KP-91 DC, KP-95 DAO, P-91 DAO, P-85, P-89, P-93, P-94, P-95 D			
Sig Sauer* P226, P228, P229, P250C 9mm, .40, P226R MK25			
Smith & Wesson* 59, 459, 469, 659, 669, 910, 915, 4006, 4013TSW, 4026, 4053TSW, 5903, 5904, 5906, 5923, 5924, 5926, 5946, 6904, 6906, 6924, 6926, 6946			
Springfield Armory XD 9mm, .40			
Taurus PT-92, PT-92C, PT-99, PT-99C, PT-101			
Beretta 8045F	Plain Basket Hi Gloss	Black Black Black	73-83-2 73-83-4 73-83-9
Glock 17, 19, 22, 23, 34, 35	STX Plain STX Basket STX Hi Gloss STX Tactical	Black Black Black Black	73-83-41 73-83-48 73-83-49 73-83-13
Heckler & Koch USP 9mm, 9C, 40, 40C			
Sig Sauer SP2340			
Smith & Wesson M&P 9mm, .40			
Smith & Wesson Sigma 9C, Sigma 40C, Sigma 9F, Sigma 40F, SW9V, SW40V, SW99			
Smith & Wesson 39, 439, 639, 909, 3904, 3906, 3953, 3913, 3914, 3954, 3913LS, 3913NL, 3914LS, 3913TSW, 3953TSW	Plain Basket Hi Gloss STX Plain STX Basket STX Hi Gloss STX Tactical	Black Black Black Black Black Black Black	73-118-2 73-118-4 73-118-9 73-118-41 73-118-48 73-118-49 73-118-13
Sig Sauer P225, P239			
Walther P5, P-7, P38			

*For Smith & Wesson and Sig Sauer 20-round magazines, use center code #276. i.e. 73-276-2

Duty Accessories

73 DOUBLE DUTY OPEN TOP MAGAZINE POUCH (continued)

How to Order
Duty Holsters
Duty Accessories
Tactical Holsters
Tactical Accessories
Duty Belts
OAS
Speed Loaders
Light Systems
Concealment Holsters
Concealment Accessories
Competition
Apparel
Sales Support
Index/Price List

GUN DESCRIPTION	FINISH	COLOR	PART NO.
Glock 20, 21	Plain Basket	Black Black	73-383-2 73-383-4
Heckler & Koch USP 9mm, .40, USP 45C, USP .45	Hi Gloss STX Plain STX Basket STX Hi Gloss STX Tactical	Black Black Black Black Black	73-383-9 73-383-41 73-383-48 73-383-49 73-383-13
Para-Ordinance P14, P16			
Springfield Armory XD .45			
Strayer-Voigt Infinity STI/SVI			
AMT Hardballer	Plain Basket Hi Gloss	Black Black Black	73-53-2 73-53-4 73-53-9
Beretta 92FCM, 92FM, 92DM	STX Plain STX Basket STX Hi Gloss STX Tactical	Black Black Black Black	73-53-41 73-53-48 73-53-49 73-53-13
Colt Combat Elite, Commander, Delta Elite, Delta Gold Cup Nat'l Match, Government 1911, Officers' ACP .45			
Heckler & Koch P7, P7M8			
Kimber KIP45CUS			
Ruger P-90			
Sig Sauer P220			
Smith & Wesson 4013, 4053, 645, 1006, 1026, 1046, 1066, 1076, 1086, 4506, 4506-1, 4513TSW, 4516-1, 4516-2, 4526, 4536, 4546, 4556, 457, 4576, 4586			

Duty Accessories

74 MAGAZINE AND RIFLE POUCH

FEATURES

- ▶ Designed to carry two handgun magazines and one rifle magazine
- ▶ Adjustable tension device to help retain magazine in pouch
- ▶ Optimal for duty officers with carbine or rifle within vehicle

GUN DESCRIPTION	FINISH*	COLOR	PART NO.
Beretta 8000, 8040, 92Brigadier, 92D, 92DS, 92F, 92FC 92FCDA, 92FS, 92FS Centurion, 92G, 96, 96 Brigadier, 96D, 96DC, 96DS, 96G, 96 Centurion	Plain Basket Hi Gloss STX Tactical	Black Black Black Black	74-76-2 74-76-4 74-76-9 74-76-13PBL
Browning BDM 9mm			
Heckler & Koch P7M13			
Ruger KP-89, KP-89DAO, KP-89DAOW, KP-89DC, KP-89 DW, KP-89W, KP-91DC, KP-91DAO, KP-95D, KP-95DAO, KP-944, KP-944DAO, KP-944DAOW, KP-944DC, KP-944DW, KP-944W, P-85, P-89, P-89DC, P-89DW, P-89W, P-91DC, P-91DAO, P-93, P-94, P-95, P-95D, P-95DAO			
Sig Sauer P226, P228, P229, P226R MK25			
Smith & Wesson 59, 459, 469, 659, 669, 910, 915, 4006, 4013TSW, 4026, 4053TSW, 5903, 5904, 5906, 5923, 5924, 5926, 5946, 6904, 6906, 6924, 6926, 6946, M&P 9mm, .40			
Springfield Armory XD 9mm, .40			
Taurus PT-92, PT-92C, PT-99, PT-99C, PT-101			
Glock 17, 22, 31, 34, 35	Plain Basket Hi Gloss	Black Black Black	74-83-2 74-83-4 74-83-9
Heckler & Koch USP 9C, 40C	STX Tactical	Black	74-83-13PBL
Sig Sauer SP2340			
Smith & Wesson M&P 9mm, .40			
Smith & Wesson Sigma 9C, 40C, 9E, 9mm, 40F SW9V, SW49V, SW99			
Glock 20, 21	Plain Basket Hi Gloss STX Tactical	Black Black Black Black	74-383-2 74-383-4 74-383-9 74-383-13PBL

*Available in these Additional Colors & Finishes:
Sample Code 74-X-41PBL

Nylon Look	74-X-22PBL	STX Plain	74-X-41PBL
Foliage Green	74-X-54PBL	STX Basket	74-X-48PBL
Coyote Brown	74-X-76PBL	STX Hi Gloss	74-X-49PBL
FDE Brown	74-X-55PBL		



How to Order
Duty Holsters
Duty Accessories
Tactical Holsters
Tactical Accessories
Duty Belts
QAS
Speed Loaders
Light Systems
Concealment Holsters
Concealment Accessories
Competition
Apparel
Sales Support
Index/Price List

Duty Accessories

75 OPEN TOP DOUBLE MAGAZINE POUCH



FEATURES

- ▶ Open-top design
- ▶ Low cut and span between pouches for quick retrieval
- ▶ Tension screw allows retention adjustment

GUN DESCRIPTION	FINISH	COLOR	PART NO.
Beretta 8000,8040, 92 Brigadier 92D, 92DS, 92F, 92FC, 92FCDA, 92FS, 92FS Centurion, 92G, 96, 96 Brigadier, 96D, 96DC, 96DS, 96G, 96 Centurion, 90-Two	Plain Basket Hi Gloss STX Plain STX Basket STX Hi Gloss STX Tactical	Black Black Black Black Black Black Black	75-76-2 75-76-4 75-76-9 75-76-41 75-76-48 75-76-49 75-76-13
Browning BDM 9mm			
Heckler & Koch P7M13			
Heckler & Koch P2000			
Ruger KP-89, KP-89 DAO, KP-89 DC, DP-89 DW, KP-89 W, KP-91 DC, KP-95 D, KP-95 DAO, P-91 DAO, P-85, P-89, P-93, P-94, P-95 D			
Sig Sauer P226, P228, P226R MK25, P229			
Smith & Wesson 59, 459, 469, 659, 669, 910, 915, 4006, 4013TSW, 4026, 4053TSW, 5903, 5904, 5906, 5923, 5924, 5926, 5946, 6904, 6906, 6924, 6926, 6946			
Springfield Armory XD 9mm, .40			
Taurus PT-92, PT-92C, PT-99, PT-99C, PT-101			
Beretta 8045F	Plain Basket Hi Gloss	Black Black Black	75-83-2 75-83-4 75-83-9
Glock 17, 19, 22, 23, 34, 35	STX Plain STX Basket STX Hi Gloss	Black Black Black	75-83-41 75-83-48 75-83-49
Heckler & Koch USP 9mm, 9C, .40, 40C	STX Tactical	Black	75-83-13
Sig Sauer SP2340			
Smith & Wesson M&P 9mm, .40			
Smith & Wesson Sigma 9C, Sigma 40C, Sigma 9F, Sigma 40F, SW9V, SW40V, SW99			
Smith & Wesson 39, 439, 639, 909, 3904, 3906, 3953, 3913,3914, 3953, 3954, 3913LS, 3913NL, 3914LS, 3913TSW, 3953TSW	Plain Basket Hi Gloss STX Plain STX Basket STX Hi Gloss STX Tactical	Black Black Black Black Black Black Black	75-118-2 75-118-4 75-118-9 75-118-41 75-118-48 75-118-49 75-118-13
Sig Sauer P225, P239			
Walther P5, P-7, P38			

All guns listed in this section utilize the above listed part numbers. The next section starts on the next page.

Duty Accessories

75 OPEN TOP DOUBLE MAGAZINE POUCH (continued)

GUN DESCRIPTION	FINISH	COLOR	PART NO.
Glock 20, 21	Plain	Black	75-383-2
	Basket	Black	75-383-4
	Hi Gloss	Black	75-383-9
Heckler & Koch USP 9mm, .40, .45 USP 45C	STX Plain	Black	75-383-41
	STX Basket	Black	75-383-48
	STX Hi Gloss	Black	75-383-49
	STX Tactical	Black	75-383-13
Para-Ordnance P14, P16			
Strayer-Voigt Infinity STI/SVI			
<hr/>			
AMT Hardballer	Plain	Black	75-53-2
	Basket	Black	75-53-4
	Hi Gloss	Black	75-53-9
Beretta 92FCM, 92FM, 92DM	STX Plain	Black	75-53-41
	STX Basket	Black	75-53-48
	STX Hi Gloss	Black	75-53-49
	STX Tactical	Black	75-53-13
Colt Combat Elite Commander Delta Elite Delta Gold Cup, Gold Cup Nat'l Match Government 1911 Officers' ACP .45			
Heckler & Koch P7, P7M8			
Kimber KIP45CUS			
Ruger P-90			
Sig Sauer P220			
Smith & Wesson 4013, 4053, 645, 1006, 1026, 1046, 1066, 1076, 1086, 4506, 4506-1, 4513TSW, 4516-1, 4516-2, 4526, 4536, 4546, 4553TSW, 4556, 4566, 457, 4576, 4586			

How to Order
Duty Holsters
Duty Accessories
Tactical Holsters
Tactical Accessories
Duty Belts
QAS
Speed Loaders
Light Systems
Concealment Holsters
Concealment Accessories
Competition
Apparel
Sales Support
Index/Price List

Duty Accessories

76 SINGLE MAGAZINE POUCH



FEATURES

- ▶ Several sizes to fit most popular magazines
- ▶ Vertical carry
- ▶ Constructed of SafariLaminate™ construction

GUN DESCRIPTION	FINISH*	COLOR	SNAP	PART NO.
AMT	Plain	Black	Chrome	76-53-2
Hardballer	Plain	Black	Brass	76-53-2B
	Plain	Black	Hidden	76-53-2HS
Beretta	Basket	Black	Chrome	76-53-4
92FCM	Basket	Black	Brass	76-53-4B
	Basket	Black	Hidden	76-53-4HS
Colt	Hi Gloss	Black	Chrome	76-53-9
Combat Elite	Hi Gloss	Black	Brass	76-53-9B
Commander	Hi Gloss	Black	Hidden	76-53-9HS
Delta Elite	STX Tactical	Black	Black	76-53-13PBL
Delta Gold Cup				
Gold Cup Nat'l Match				
Government 1911				
Officers' ACP .45				
Kimber				
KIP45CUS				
Sig Sauer				
P220, P225, P220R Compact				
Smith & Wesson				
39, 439, 639, 909, 3904,				
3906, 3913, 3913 LS,				
3913TSW, 3914, 3914 LS,				
3953, 3953TSW, 3954, 4053,				
CS9				
Beretta	Plain	Black	Chrome	76-76-2
8000, 8040, 92 Brigadier,	Plain	Black	Brass	76-76-2B
92D, 92DS, 92F, 92FC,	Plain	Black	Hidden	76-76-2HS
92FCDA, 92FDA,	Basket	Black	Chrome	76-76-4
92FS, 92FS Centurion,	Basket	Black	Brass	76-76-4B
92G, 96 Brigadier,	Basket	Black	Hidden	76-76-4HS
96DA, 96DC, 96DS, 96F,	Hi Gloss	Black	Chrome	76-76-9
96FS, 96G, 96 Centurion	Hi Gloss	Black	Brass	76-76-9B
	Hi Gloss	Black	Hidden	76-76-9HS
Browning	STX Tactical	Black	Black	76-76-13PBL
BDM 9mm				
Heckler & Koch				
P7M13				
Ruger				
KP-89, KP-89 DAO,				
KP-89 DAOW, KP-89 DC,				
KP-89 DW, KP-89 W, KP-91 DC,				
KP-91 DAO, KP-95D, KP-95 DAO,				
KP-944, KP-944 DAO, KP-944 DAOW,				
KP-944 DC, KP-944 DW, KP-944 W, P-85, P-89,				
P-89 DC, P-89 DW, P-89 W, P-91 DAO,				
P-91 DC, P-93, P-94, P-95 D, P-95 DAO				
Sig Sauer*				
P226, P228, P250, P226R MK25, P229				
Smith & Wesson*				
59, 459, 469, 659, 669,				
910, 915, 4006, 4013TSW				
4026, 4053TSW, 5903,				
5904, 5924, 5906, 5923,				
5926, 5946, 6904, 6906,				
6924, 6926, 6946,				
4046				
Springfield Armory				
XD 9mm, .40				
Taurus				
PT-92, PT-92C, PT-99, PT-99C, PT-101				

*Available in these additional finishes:

Sample Codes

Nylon Look	76-XX-22PBL
Foliage Green	76-XX-54PBL
Coyote Brown	76-XX-76PBL
FDE Brown	76-XX-55PBL
STX Plain	76-XX-41PBL
STX Basket	76-XX-48PBL
STX Hi Gloss	76-XX-49PBL

Available in a tactical configuration, see page 162 for part information.

*For Smith & Wesson and Sig Sauer 20 round magazines, use center code #276. i.e. 76-276-2

Duty Accessories

76 SINGLE MAGAZINE POUCH (continued)

GUN DESCRIPTION	FINISH*	COLOR	SNAP	PART NO.
Glock 17, 19, 22, 23, 34, 35	Plain	Black	Chrome	76-83-2
	Plain	Black	Brass	76-83-2B
	Plain	Black	Hidden	76-83-2HS
Glock* 17 + 2	Basket	Black	Chrome	76-83-4
	Basket	Black	Brass	76-83-4B
	Basket	Black	Hidden	76-83-4HS
Heckler & Koch USP 9C, 40C, P2000, US Version 12 Round	Hi Gloss	Black	Chrome	76-83-9
	Hi Gloss	Black	Brass	76-83-9B
	Hi Gloss	Black	Hidden	76-83-9HS
	STX Tactical	Black	Black	76-83-13PBL
Sig Sauer SP2340	*For Glock 17 + 2 or Springfield XD(M) .40, use center code 083. i.e. 76-083-2			
Smith & Wesson M&P 9mm, .40				
Smith & Wesson Sigma 9C, Sigma 40C, Sigma 9F, Sigma 40F, SW9V, SW40V, SW99				
Springfield Armory* XD(M) .40				
Glock 20, 21	Plain	Black	Chrome	76-383-2
	Plain	Black	Brass	76-383-2B
	Plain	Black	Hidden	76-383-2HS
Heckler & Koch USP 45C	Basket	Black	Chrome	76-383-4
	Basket	Black	Brass	76-383-4B
	Basket	Black	Hidden	76-383-4HS
Para-Ordnance P14	Hi Gloss	Black	Chrome	76-383-9
	Hi Gloss	Black	Brass	76-383-9B
	Hi Gloss	Black	Hidden	76-383-9HS
	STX Tactical	Black	Black	76-383-13PBL
Ruger P-90	Plain	Black	Chrome	76-210-2
	Plain	Black	Brass	76-210-2B
	Plain	Black	Hidden	76-210-2HS
Smith & Wesson 645, 1006, 1026, 1046, 1066, 1076, 1086, 4506, 4506-1, 4513TSW, 4516-1, 4516-2, 4526, 4536, 4546, 4553TSW, 4556, 4566, 457, 4576, 4586	Basket	Black	Chrome	76-210-4
	Basket	Black	Brass	76-210-4B
	Basket	Black	Hidden	76-210-4HS
	Hi Gloss	Black	Chrome	76-210-9
	Hi Gloss	Black	Brass	76-210-9B
	Hi Gloss	Black	Hidden	76-210-9HS
	STX Tactical	Black	Black	76-210-13PBL
Heckler & Koch P7, P7M8	Plain	Black	Chrome	76-118-2
	Plain	Black	Brass	76-118-2B
	Plain	Black	Hidden	76-118-2HS
Smith & Wesson 3953, 3913, 3914, 3953, 3954, 3913LS, 3913NL, 3914LS, 3913TSW, 3953TSW	Basket	Black	Chrome	76-118-4
	Basket	Black	Brass	76-118-4B
	Basket	Black	Hidden	76-118-4HS
	Hi Gloss	Black	Chrome	76-118-9
	Hi Gloss	Black	Brass	76-118-9B
Sig Sauer P225, P239	Hi Gloss	Black	Hidden	76-118-9HS
	STX Tactical	Black	Black	76-118-13PBL
Walther P5, P-7, P38				
Heckler & Koch P2000 16-Round	Plain	Black	Chrome	76-97-2
	Plain	Black	Brass	76-97-2B
	Basket	Black	Chrome	76-97-4
	Basket	Black	Brass	76-97-4B
	Hi Gloss	Black	Chrome	76-97-9
	Hi Gloss	Black	Brass	76-97-9B
	STX Tactical	Black	Black	76-97-13PBL

How to Order
Duty Holsters
Duty Accessories
Tactical Holsters
Tactical Accessories
Duty Belts
QAS
Speed Loaders
Light Systems
Concealment Holsters
Concealment Accessories
Competition
Apparel
Sales Support
Index/Price List

Duty Accessories

76 SINGLE MAGAZINE POUCH (continued)

How to Order
Duty Holsters
Duty Accessories
Tactical Holsters
Tactical Accessories
Duty Belts
OAS
Speed Loaders
Light Systems
Concealment Holsters
Concealment Accessories
Competition
Apparel
Sales Support
Index/Price List

GUN DESCRIPTION	FINISH*	COLOR	SNAP	PART NO.
FN FN Five-Seven	Plain	Black	Chrome	76-61-2
	Plain	Black	Brass	76-61-2B
	Plain	Black	Hidden	76-61-2HS
	Basket	Black	Chrome	76-61-4
	Hi Gloss	Black	Chrome	76-61-9
	Hi Gloss	Black	Brass	76-61-9B
	Hi Gloss	Black	Hidden	76-61-9HS
	STX Tactical	Black	Black	76-61-13PBL
Heckler & Koch P30	Plain	Black	Chrome	76-295-2
	Plain	Black	Brass	76-295-2B
	Plain	Black	Hidden	76-295-2HS
	Basket	Black	Chrome	76-295-4
	Basket	Black	Brass	76-295-4B
	Basket	Black	Hidden	76-295-4HS
	Hi Gloss	Black	Chrome	76-295-9
	Hi Gloss	Black	Brass	76-295-9B
	Hi Gloss	Black	Hidden	76-295-9HS
	STX Tactical	Black	Black	76-295-13PBL
Smith & Wesson M&P .45	Plain	Black	Chrome	76-419-2
	Plain	Black	Brass	76-419-2B
	Plain	Black	Hidden	76-419-2HS
	Basket	Black	Chrome	76-419-4
	Basket	Black	Brass	76-419-4B
	Basket	Black	Hidden	76-419-4HS
	Hi Gloss	Black	Chrome	76-419-9
	Hi Gloss	Black	Brass	76-419-9B
	Hi Gloss	Black	Hidden	76-419-9HS
	STX Tactical	Black	Black	76-419-13PBL

Duty Accessories

77 DOUBLE MAGAZINE POUCH

FEATURES

- ▶ Vertical/horizontal belt slots for regular/low-profile position
- ▶ Tension screw allows you to adjust magazine retention
- ▶ Span between pouches plus low cut allow quick, easy drawing

GUN DESCRIPTION	FINISH*	COLOR	SNAP	PART NO.
AMT	Plain	Black	Chrome	77-53-2
Hardballer	Plain	Black	Brass	77-53-2B
	Plain	Black	Hidden	77-53-2HS
Beretta	Basket	Black	Chrome	77-53-4
92Fcm, 92 FM, 92 DM	Basket	Black	Brass	77-53-4B
	Basket	Black	Hidden	77-53-4HS
Colt	Hi Gloss	Black	Chrome	77-53-9
Combat Elite	Hi Gloss	Black	Brass	77-53-9B
Commander, Delta Elite	Hi Gloss	Black	Hidden	77-53-9HS
Delta Gold Cup	STX Tactical	Black	Black	77-53-13PBL
Gold Cup Nat'l Match				
Government 1911				
Officers' ACP .45				
Kimber				
KIP45CUS				
Sig Sauer				
P220, P220R Compact				
Smith & Wesson				
39, 439, 639, 909, 3904, 3906, 4013, 4053 CS9				
Beretta	Plain	Black	Chrome	77-76-2
8000, 8040, 92 Brigadier,	Plain	Black	Brass	77-76-2B
92D, 92DS, 92F, 92FC,	Plain	Black	Hidden	77-76-2HS
92FCDA, 92FS,	Basket	Black	Chrome	77-76-4
92FS Centurion, 92G,	Basket	Black	Brass	77-76-4B
96, 96 Brigadier,	Basket	Black	Hidden	77-76-4HS
96D, 96DC, 96DS,	Hi Gloss	Black	Chrome	77-76-9
96G, 96 Centurion	Hi Gloss	Black	Brass	77-76-9B
	Hi Gloss	Black	Hidden	77-76-9HS
Browning	STX Tactical	Black	Black	77-76-13PBL
BDM 9mm				
Heckler & Koch				
P7M13				
Ruger				
KP-89, KP-89 DAO,				
KP-89 DAOW, KP-89 DC,				
KP-89 DW, KP-89 W, KP-91 DC,				
KP-91 DAO, KP-95 D, KP-95 DAO,				
KP-944, KP-944 DAO, KP-944 DAOW,				
KP-944 DC, KP-944 DW, KP-944 W, P-85,				
P-89, P-89 DC, P-89 DW, P-89 W, P-91 DC,				
P-91 DAO, P-93, P-94, P-95 D, P-95 DAO				
Sig Sauer*				
P226, P228, P226 MK25, P229				
Smith & Wesson*				
59, 459, 469, 659, 669, 910, 915, 4006, 4013TSW, 4026, 4053TSW, 5903, 5904, 5906, 5923, 5924, 5926, 5946, 6904, 6906, 6924, 6926, 6946				
Springfield Armory				
XD 9mm, .40				
Taurus				
PT-92, PT-92C, PT-99, PT-99C, PT-101				
Beretta	Plain	Black	Chrome	77-83-2
8045F	Plain	Black	Brass	77-83-2B
	Plain	Black	Hidden	77-83-2HS
Glock	Basket	Black	Chrome	77-83-4
17, 22, 34, 35	Basket	Black	Brass	77-83-4B
	Basket	Black	Hidden	77-83-4HS
Glock*	Hi Gloss	Black	Chrome	77-83-9
17 + 2	Hi Gloss	Black	Brass	77-83-9B
	Hi Gloss	Black	Hidden	77-83-9HS
Heckler & Koch	STX Tactical	Black	Black	77-83-13PBL
USP 9C, 40C, USP 9,40 P2000 US Version 12-Round				
Sig Sauer				
SP2340, P250				
Smith & Wesson				
M&P 9mm, .40				

*For Smith & Wesson and Sig Sauer 20-round magazines, use center code #276. I.e. 77-276-2

*For Glock 17 + 2 or Springfield XD(M). 40, use center code 083. I.e. 77-083-2



*Available in these additional finishes:

Sample Codes	
Nylon Look	77-XX-22PBL
Foliage Green	77-XX-54PBL
Coyote Brown	77-XX-76PBL
FDE Brown	77-XX-55PBL
STX Plain	77-XX-41PBL
STX Basket	77-XX-48PBL
STX Hi Gloss	77-XX-49PBL

Available in a tactical configuration, see page 163 for part information.

Duty Accessories

77 DOUBLE MAGAZINE POUCH (continued)

How to Order
Duty Holsters
Duty Accessories
Tactical Holsters
Tactical Accessories
Duty Belts
OAS
Speed Loaders
Light Systems
Concealment Holsters
Concealment Accessories
Competition
Apparel
Sales Support
Index/Price List

GUN DESCRIPTION	FINISH*	COLOR	SNAP	PART NO.
Smith & Wesson Sigma 9C, Sigma 40C, Sigma 9F, Sigma 40F, SW9V, SW40V, SW99	Plain	Black	Chrome	77-83-2
	Plain	Black	Brass	77-83-2B
	Plain	Black	Hidden	77-83-2HS
	Basket	Black	Chrome	77-83-4
	Basket	Black	Brass	77-83-4B
	Basket	Black	Hidden	77-83-4HS
Springfield Armory* XD(M) .40	Hi Gloss	Black	Chrome	77-83-9
	Hi Gloss	Black	Brass	77-83-9B
	Hi Gloss	Black	Hidden	77-83-9HS
	STX Tactical	Black	Black	77-83-13PBL
Glock 20, 21	Plain	Black	Chrome	77-383-2
	Plain	Black	Brass	77-383-2B
Para-Ordnnance P14	Plain	Black	Hidden	77-383-2HS
	Basket	Black	Chrome	77-383-4
	Basket	Black	Brass	77-383-4B
	Basket	Black	Hidden	77-383-4HS
	Hi Gloss	Black	Chrome	77-383-9
	Hi Gloss	Black	Brass	77-383-9B
	Hi Gloss	Black	Hidden	77-383-9HS
STX Tactical	Black	Black	77-383-13PBL	
Ruger P-90	Plain	Black	Chrome	77-210-2
	Plain	Black	Brass	77-210-2B
	Plain	Black	Hidden	77-210-2HS
Smith & Wesson 645, 1006, 1026, 1046, 1066, 1076, 1086, 4506, 4506-1, 4513TSW, 4516-1, 4516-2, 4526, 4536, 4546, 4553TSW, 4556, 4566, 457, 4576, 4586	Basket	Black	Chrome	77-210-4
	Basket	Black	Brass	77-210-4B
	Basket	Black	Hidden	77-210-4HS
	Hi Gloss	Black	Chrome	77-210-9
	Hi Gloss	Black	Brass	77-210-9B
	Hi Gloss	Black	Hidden	77-210-9HS
	STX Tactical	Black	Black	77-210-13PBL
Heckler & Koch P7, P7M8	Plain	Black	Chrome	77-118-2
	Plain	Black	Brass	77-118-2B
	Plain	Black	Hidden	77-118-2HS
	Basket	Black	Chrome	77-118-4
	Basket	Black	Brass	77-118-4B
Smith & Wesson 3953, 3913, 3914, 3953, 3954, 3913LS, 3913NL, 3914LS, 3913TSW, 3953TSW	Basket	Black	Hidden	77-118-4HS
	Hi Gloss	Black	Chrome	77-118-9
	Hi Gloss	Black	Brass	77-118-9B
	Hi Gloss	Black	Hidden	77-118-9HS
Sig Sauer P225, P239	STX Tactical	Black	Black	77-118-13PBL
Walther P5, P-7, P38				
Glock 19, 23	Plain	Black	Chrome	77-283-2
	Plain	Black	Brass	77-283-2B
	Plain	Black	Hidden	77-283-2HS
	Plain	Black	Chrome	77-283-4
	Plain	Black	Brass	77-283-2B
	Plain	Black	Hidden	77-283-2HS
	Basket	Black	Chrome	77-283-4
	Basket	Black	Brass	77-283-4B
	Basket	Black	Hidden	77-283-4HS
	Hi Gloss	Black	Chrome	77-283-9
	Hi Gloss	Black	Brass	77-283-9B
	Hi Gloss	Black	Hidden	77-283-9HS
	STX Tactical	Black	Black	77-283-13PBL
Heckler & Koch .45 16-Round MK 23	Plain	Black	Chrome	77-94-2
	Plain	Black	Brass	77-94-2B
	Plain	Black	Hidden	77-94-2HS
	Basket	Black	Chrome	77-94-4
	Basket	Black	Brass	77-94-4B
	Basket	Black	Hidden	77-94-4HS
	Hi Gloss	Black	Chrome	77-94-9
	Hi Gloss	Black	Brass	77-94-9B
	Hi Gloss	Black	Hidden	77-94-9HS
	STX Tactical	Black	Black	77-94-13PBL
Heckler & Koch P2000 16-Round	Plain	Black	Chrome	77-97-2
	Plain	Black	Brass	77-97-2B
	Basket	Black	Chrome	77-97-4
	Basket	Black	Brass	77-97-4B
	Hi Gloss	Black	Chrome	77-97-9
	Hi Gloss	Black	Brass	77-97-9B
	STX Tactical	Black	Black	77-97-13PBL
Smith & Wesson M&P .45	Basket	Black	Chrome	77-419-4
	Basket	Black	Brass	77-419-4B
	Basket	Black	Hidden	77-419-4HS
	Hi Gloss	Black	Chrome	77-419-9
	Hi Gloss	Black	Brass	77-419-9B
	Hi Gloss	Black	Hidden	77-419-9HS
STX Tactical	Black	Black	77-419-13PBL	

Duty Accessories

78 SLIMLINE DOUBLE MAGAZINE POUCH

FEATURES

- ▶ Magazines are oriented "bullets out" to save space on belt
- ▶ Durable SafariLaminate™ construction
- ▶ Optimal for use on tactical rigs due to minimal width
- ▶ Vertical and horizontal belt slots
- ▶ Fits 2.25" (58mm) belt widths



GUN DESCRIPTION	FINISH*	COLOR	SNAP	PART NO
AMT Hardballer	Plain	Black	Chrome	78-53-2*
Beretta 92FCM, 92 FM, 92DM	Plain	Black	Brass	78-53-2B*
Colt Combat Elite, Commander, Delta Elite, Delta Gold Cup Gold Cup Nat'l Match, Government 1911, Officers' ACP .45	Hi Gloss	Black	Chrome	78-53-9*
	Basket	Black	Brass	78-53-9B*
Kimber KIP45CUS	STX Tactical	Black	Chrome	78-53-4*
			Black	78-53-13BL*
Sig Sauer P220, P220R Compact				
Smith & Wesson 39, 439, 639, 909, 3904, 3906, 4013, 4053, CS9				
				*This fit available in vertical carry only.
Beretta 8000, 8040, 92 Brigadier, 92D, 92DS, 92F, 92FC, 92FCDA, 92FS, 92FS Centurion, 92G, 96, 96 Brigadier, 96D, 96DC, 96DS, 96G, 96 Centurion	Plain	Black	Chrome	78-76-2
Browning BDM 9mm	Plain	Black	Brass	78-76-2B
	Hi Gloss	Black	Chrome	78-76-9
Heckler & Koch P7M13	Hi Gloss	Black	Brass	78-76-9B
	Basket	Black	Chrome	78-76-4
Ruger KP-89, KP-89 DAO, KP-89 DAOW, KP-89 DC, KP-89 DW, KP-89 W, KP-91 DC, KP-91 DAO, KP-95 D, KP-95 DAO, KP-944, KP-944 DAO, KP-944 DAOW, KP-944 DC, KP-944 DW, KP-944 W, P-85, P-89, P-89 DC, P-89 DW, P-89 W, P-91 DC, P-91 DAO, P-93, P-94, P-95 D, P-95 DAO	STX Tactical	Black	Black	78-76-13PBL
Sig Sauer P226, P228, P226 MK25, P229				
Smith & Wesson 59, 459, 469, 659, 669, 910, 915, 4006, 4013TSW, 4026, 4053TSW, 5903, 5904, 5906, 5923, 5924, 5926, 5946, 6904, 6906, 6924, 6926, 6946				
Springfield Armory XD 9mm, .40				
Taurus PT-92, PT-92C, PT-99, PT-99C, PT-101				
Beretta 8045F	Plain	Black	Brass	78-83-2B
Glock 17, 22, 34, 35	Basket	Black	Chrome	78-83-4
	Hi Gloss	Black	Chrome	78-83-9
Heckler & Koch USP 9C, 40C, P2000 12-Round	Hi Gloss	Black	Brass	78-83-9B
	Basket	Black	Chrome	78-83-4
Sig Sauer SP2340	Basket	Black	Brass	78-83-4B
	STX Tactical	Black	Black	78-83-13PBL
Smith & Wesson Sigma 9C, Sigma 40C, Sigma 9F, Sigma 40F, SW9V, SW40V, SW99, M&P 9mm, .40				
Glock 20, 21	Plain	Black	Chrome	78-383-2
	Plain	Black	Brass	78-383-2B
Heckler & Koch USP 9mm, .40, USP 45C	Hi Gloss	Black	Chrome	78-383-9
	Hi Gloss	Black	Brass	78-383-9B
Para-Ordnance P14	Basket	Black	Chrome	78-383-4
	STX Tactical	Black	Brass	78-383-4B
Sig Sauer P250C 9mm, .40	Basket	Black	Black	78-383-13PBL
	Plain	Black	Chrome	78-119-2
Smith & Wesson M&P 45C	Plain	Black	Brass	78-119-2B
	Hi Gloss	Black	Chrome	78-119-9
Smith & Wesson M&P 45C	Hi Gloss	Black	Brass	78-119-9B
	Basket	Black	Chrome	78-119-4
	Basket	Black	Brass	78-119-4B
	STX Tactical	Black	Black	78-119-13PBL

*Available in these additional finishes:

Sample Codes	
Nylon Look	78-XX-22PBL
Foliage Green	78-XX-54PBL
Coyote Brown	78-XX-76PBL
FDE Brown	78-XX-55PBL
STX Plain	78-XX-41PBL
STX Basket	78-XX-48PBL
STX Hi Gloss	78-XX-49PBL

Available in a tactical configuration, see page 141 for part information.

Duty Accessories

79 SLIMLINE OPEN TOP DOUBLE MAGAZINE POUCH



FEATURES

- ▶ Magazines are oriented "bullets out" to save space on duty belt
- ▶ Durable SafariLaminate™ construction
- ▶ Optimal use on tactical rigs due to minimal width
- ▶ Vertical belt slots
- ▶ Fits 2.25" (58mm) belt width

GUN DESCRIPTION	FINISH*	COLOR	PART NO.
AMT Hardballer	Plain	Black	79-53-2
	Basket	Black	79-53-4
Beretta 92FCM, 92FM, 92DM	Hi Gloss	Black	79-53-9
	STX Tactical	Black	79-53-13
Colt Combat Elite, Commander, Delta Elite, Delta Gold Cup, Gold Cup Nat'l Match, Government 1911, Officers' ACP .45			
Kimber KIP45CUS			
Sig Sauer P220, P220R Compact			
Smith & Wesson 39, 439, 639, 909, 3904, 3906, 4013, 4053, CS9			
Beretta 8000, 8040, 92 Brigadier, 92D, 92DS, 92F, 92FC, 92FCDA, 92FS, 92FS Centurion, 92G, 96, 96 Brigadier, 96D, 96DC, 96DS, 96G, 96 Centurion	Plain	Black	79-76-2
	Basket	Black	79-76-4
	Hi Gloss	Black	79-76-9
	STX Tactical	Black	79-76-13
Browning BDM 9mm			
Heckler & Koch P7M13			
Ruger KP-89, KP-89 DAO, KP-89 DAOW, KP-89 DC, KP-89 DW, KP-89 W, KP-91 DC, KP-91 DAO, KP-95 D, KP-95 DAO, KP-944, KP-944 DAO, KP-944 DAOW, KP-944 DC, KP-944 DW, KP-944 W, P-85, P-89, P-89 DC, P-89 DW, P-89 W, P-91 DC, P-91 DAO, P-93, P-94, P-95 D, P-95 DAO			
Sig Sauer P226, P228, P226R MK25, P229			
Smith & Wesson 59, 459, 469, 659, 669, 910, 915, 4006, 4013TSW, 4026, 4053TSW, 5903, 5904, 5906, 5923, 5924, 5926, 5946, 6904, 6906, 6924, 6926, 6946			
Springfield Armory XD 9mm, .40			
Taurus PT-92, PT-92C, PT-99, PT-99C, PT-101			
Beretta 8045F	Plain	Black	79-83-2
	Basket	Black	79-83-4
	Hi Gloss	Black	79-83-9
Glock 17, 22, 34, 35	STX Tactical	Black	79-83-13
Heckler & Koch USP 9C, 40C, P2000 12-Round			
Sig Sauer SP2340			
Sig Sauer P250C 9mm, .40			
Smith & Wesson M&P 9mm, .40			
Smith & Wesson Sigma 9C, Sigma 40C, Sigma 9F, Sigma 40F, SW9V, SW40V, SW99			
Glock 20, 21	Plain	Black	79-383-2
	Basket	Black	79-383-4
Para-Ordnance P14	Hi Gloss	Black	79-383-9
	STX Tactical	Black	79-383-13
Heckler & Koch USP 9mm, .40, USP 45C			
Smith & Wesson M&P .45, 45C	Plain	Black	79-419-2
	Basket	Black	79-419-4
	Hi Gloss	Black	79-419-9
	STX Tactical	Black	79-419-13

*Available in these additional finishes:

Sample Codes	
Nylon Look	79-XX-22
Foliage Green	79-XX-54
Coyote	79-XX-76
FDE Brown	79-XX-55
STX Plain	79-XX-41
STX Basket	79-XX-48
STX Hi Gloss	79-XX-49

Available in a tactical configuration, see page 142 for part information.

Duty Accessories

277 QUAD MAGAZINE POUCH



FEATURES

- ▶ Designed with space for up to four 1911-style magazines; also offered in 10-round versions
- ▶ Center divider retains extra magazine while fixed magazine is in use
- ▶ Vertical or horizontal belt slots for standard or low profile positions
- ▶ Ideal for agencies that require a certain amount of ammunition yet allow 1911-style weapons

*Available in these additional finishes:
 Sample Codes
 Nylon Look 277-XX-22PBL

GUN DESCRIPTION	FINISH*	COLOR	SNAP	PART NO.
Standard 1911 Single Stack Magazines	Plain	Black	Chrome	277-53-2
	Plain	Black	Brass	277-53-2B
	Plain	Black	Hidden	277-53-2HS
	Basket	Black	Chrome	277-53-4
	Basket	Black	Brass	277-53-4B
	Basket	Black	Hidden	277-53-4HS
	Hi Gloss	Black	Chrome	277-53-9
	Hi Gloss	Black	Brass	277-53-9B
	Hi Gloss	Black	Hidden	277-53-9HS
	STX Tactical	Black	Black	277-53-13PBL
10-Round 1911 Single Stack Magazines	Plain	Black	Chrome	277-1053-2
	Plain	Black	Brass	277-1053-2B
	Plain	Black	Hidden	277-1053-2HS
	Basket	Black	Chrome	277-1053-4
	Basket	Black	Brass	277-1053-4B
	Basket	Black	Hidden	277-1053-4HS
	Hi Gloss	Black	Chrome	277-1053-9
	Hi Gloss	Black	Brass	277-1053-9B
	Hi Gloss	Black	Hidden	277-1053-9HS
	STX Tactical	Black	Black	277-1053-13PBL

How to Order
Duty Holsters
Duty Accessories
Tactical Holsters
Tactical Accessories
Duty Belts
QAS
Speed Loaders
Light Systems
Concealment Holsters
Concealment Accessories
Competition
Apparel
Sales Support
Index/Price List

Duty Accessories

775 SLIMLINE OPEN TOP TRIPLE MAGAZINE POUCH



FEATURES

- ▶ Provides triple magazine retention without flap in an area comparable to standard dual magazine pouches
- ▶ Vertical and horizontal belt slots
- ▶ Durable SafariLaminate™ construction
- ▶ Magazines are oriented "bullets out" to save space
- ▶ Fits 2.25" (58mm) belt widths

GUN DESCRIPTION	FINISH*	COLOR	PART NO.
AMT Hardballer	Plain Basket	Black Black	775-53-2* 775-53-4*
Beretta 92FCM, 92FM, 92DM	Hi Gloss STX Tactical	Black Black	775-53-9* 775-53-13*
Colt Combat Elite, Commander, Delta Elite, Delta Gold Cup, Gold Cup Nat'l Match, Government 1911, Officers' ACP .45			
Kimber KIP45CUS			
Sig Sauer P220, P220R Compact			
Smith & Wesson 39, 439, 639, 909, 3904, 3906, 4013, 4053, CS9			*This fit available in vertical carry only.
Beretta 8000, 8040, 92 Brigadier, 92D 92DS, 92F, 92FC, 92FCDA, 92FS, 92FS Centurion, 92G, 96, 96 Brigadier, 96D, 96DC, 96DS, 96G, 96 Centurion	Plain Basket Hi Gloss STX Tactical	Black Black Black Black	775-76-2 775-76-4 775-76-9 775-76-13
Browning BDM 9mm			
Heckler & Koch P7M13			
Ruger KP-89, KP-89 DAO, KP-89 DAOW, KP-89 DC, KP-89 DW, KP-89 W, KP-91 DC, KP-91 DAO, KP-95 D, KP-95 DAO, KP-944, KP-944 DAO, KP-944 DAOW, KP-944 DC, KP-944 DW, KP-944 W, P-85, P-89, P-89 DC, P-89 DW, P-89 W, P-91 DC, P-91 DAO, P-93, P-94, P-95 D, P-95 DAO			
Sig Sauer P226, P228, P226R MK25, P229			
Smith & Wesson 59, 459, 469, 659, 669, 910, 915, 4006, 4013TSW, 4026, 4053TSW, 5903, 5904, 5906, 5923, 5924, 5926, 5946, 6904, 6906, 6924, 6926, 6946			
Springfield Armory XD 9mm, .40			
Taurus PT-92, PT-92C, PT-99, PT-99C, PT-101			
Beretta 8045F	Plain Basket Hi Gloss	Black Black Black	775-83-2 775-83-4 775-83-9
Glock 17, 22, 34, 35	STX Tactical	Black	775-83-13
Heckler & Koch USP 9C, USP 40C, P2000 12-Round			
Sig Sauer SP2340			
Smith & Wesson M&P 9mm, .40			
Smith & Wesson Sigma 9C, Sigma 40C, Sigma 9F, Sigma 40F, SW9V, SW40V, SW99			
Glock 20, 21	Plain Basket Hi Gloss	Black Black Black	775-383-2 775-383-4 775-383-9
Heckler & Koch USP 9mm, .40, USP 45C	STX Tactical	Black	775-383-13
Para-Ordnance P14			
Smith & Wesson M&P .45, 45C	Plain Basket Hi Gloss STX Tactical	Black Black Black Black	775-419-2 775-419-4 775-419-9 775-419-13

*Available in these additional finishes:

Sample Codes

Nylon Look 775-XX-22

Foliage Green 775-XX-54

Coyote 775-XX-76

FDE Brown 775-XX-55

STX Plain 775-XX-41

STX Basket 775-XX-48

STX Hi Gloss 775-XX-49

Available in a tactical configuration, see page 142 for part information.

Duty Accessories

777 SLIMLINE TRIPLE MAGAZINE POUCH

FEATURES

- ▶ Magazines are oriented "bullets out" to save space on duty belt
- ▶ Vertical and horizontal belt slots
- ▶ Durable SafariLaminate™ construction
- ▶ Fits 2.25" (58mm) belt widths



GUN DESCRIPTION	FINISH*	COLOR	SNAP	PART NO.
AMT Hardballer	Plain	Black	Chrome	777-53-2
	Plain	Black	Brass	777-53-2B
	Hi Gloss	Black	Chrome	777-53-9
Beretta 92FCM, 92FM, 92DM	Hi Gloss	Black	Brass	777-53-9B
	Basket	Black	Chrome	777-53-4
	Basket	Black	Brass	777-53-4B
Colt Combat Elite, Commander, Delta Elite, Delta Gold Cup, Gold Cup Nat'l Match, Government 1911, Officers' ACP .45	STX Tactical	Black	Black	777-53-13PBL
Kimber KIP45CUS				
Sig Sauer P220, P220R Compact				
Smith & Wesson 39, 439, 639, 909, 3904, 3906, 4013, 4053, CS9				
Beretta 8000, 8040, 92 Brigadier, 92D, 92DS, 92F, 92FC, 92FCDA, 92FS, 92FS Centurion, 92G, 96, 96 Brigadier, 96D, 96DC, 96DS, 96G, 96 Centurion	Plain	Black	Chrome	777-76-2
	Plain	Black	Brass	777-76-2B
	Hi Gloss	Black	Chrome	777-76-9
	Hi Gloss	Black	Brass	777-76-9B
	Basket	Black	Chrome	777-76-4
	Basket	Black	Brass	777-76-4B
	STX Tactical	Black	Black	777-76-13PBL
Browning BDM 9mm				
Heckler & Koch P7M13				
Ruger KP-89, KP-89 DAO, KP-89 DAOW, KP-89 DC, KP-89 DW, KP-89 W, KP-91 DC, KP-91 DAO, KP-95 D, KP-95 DAO, KP-944, KP-944 DAO, KP-944 DAOW, KP-944 DC, KP-944 DW, KP-944 W, P-85, P-89, P-89 DC, P-89 DW, P-89 W, P-91 DC, P-91 DAO, P-93, P-94, P-95 D, P-95 DAO				
Sig Sauer P226, P228, P226R MK25, P229				
Smith & Wesson 59, 459, 469, 659, 669, 910, 915, 4006, 4013TSW, 4026, 4053TSW, 5903, 5904, 5906, 5923, 5924, 5926, 5946, 6904, 6906, 6924, 6926, 6946				
Springfield Armory XD 9mm, .40				
Taurus PT-92, PT-92C, PT-99, PT-99C, PT-101				
Beretta 8045F	Plain	Black	Chrome	777-83-2
	Plain	Black	Brass	777-83-2B
	Hi Gloss	Black	Chrome	777-83-9
Glock 17, 22, 34, 35	Hi Gloss	Black	Brass	777-83-9B
	Basket	Black	Chrome	777-83-4
	Basket	Black	Brass	777-83-4B
Heckler & Koch USP 9mm, .40	STX Tactical	Black	Black	777-83-13PBL
Para-Ordnance P14				
Smith & Wesson M&P 9mm, .40				
Smith & Wesson Sigma 9C, Sigma 40C, Sigma 9F, Sigma 40F, SW9V, SW40V, SW99				

*Available in these additional finishes:

Sample Codes	
Nylon Look	777-XX-22PBL
Foliage Green	777-XX-54PBL
Coyote	777-XX-76PBL
FDE Brown	777-XX-55PBL
STX Plain	777-XX-41PBL
STX Basket	777-XX-48PBL
STX Hi Gloss	777-XX-49PBL

Available in a tactical configuration, see page 142 for part information.

Duty Accessories

777 SLIMLINE TRIPLE MAGAZINE POUCH (continued)

GUN DESCRIPTION	FINISH*	COLOR	SNAP	PART NO.
Glock 20, 21	Plain	Black	Chrome	777-383-2
	Plain	Black	Brass	777-383-2B
	Hi Gloss	Black	Chrome	777-383-9
Heckler & Koch USP 9mm, .40, USP 45C	Hi Gloss	Black	Brass	777-383-9B
	Basket	Black	Chrome	777-383-4
	Basket	Black	Brass	777-383-4B
Para-Ordnance P14	STX Tactical	Black	Black	777-383-13PBL
	<hr/>			
Smith & Wesson M&P 45C	Plain	Black	Chrome	777-119-2
	Plain	Black	Brass	777-119-2B
	Hi Gloss	Black	Chrome	777-119-9
	Hi Gloss	Black	Brass	777-119-9B
	Basket	Black	Chrome	777-119-4
	Basket	Black	Brass	777-119-4B
	STX Tactical	Black	Black	777-119-13PBL

7350-01 BADGE HOLDER, CLIP-ON



COLOR	PART NO.
Black	7350-01-2

FEATURES

- ▶ Round for badge
- ▶ Metal clip
- ▶ Diameter: 3" (76mm)

7350-03 BADGE HOLDER, CLIP-ON



COLOR	PART NO.
Black	7350-03-2

FEATURES

- ▶ Oval shield badge
- ▶ Metal clip
- ▶ Diameter: 3" (76mm)

Duty Accessories

7350-04 BADGE HOLDER, CLIP-ON

COLOR	PART NO.
Black	7350-04-2

FEATURES

- ▶ Oval shield badge
- ▶ Metal clip
- ▶ Diameter: 3" (76mm)



7352 BADGE HOLDER W/NECK CHAIN

COLOR	PART NO.
Black	7352-2

FEATURES

- ▶ Shaped for shield-style badges
- ▶ 2.5" x 3.5" (64mm x 89mm)



How to Order
Duty Holsters
Duty Accessories
Tactical Holsters
Tactical Accessories
Duty Belts
QAS
Speed Loaders
Light Systems
Concealment Holsters
Concealment Accessories
Competition
Apparel
Sales Support
Index/Price List

Tactical Holsters

TACTICAL HOLSTERS CAN BE CONFIGURED WITH ANY OF THESE ATTACHMENT SYSTEMS

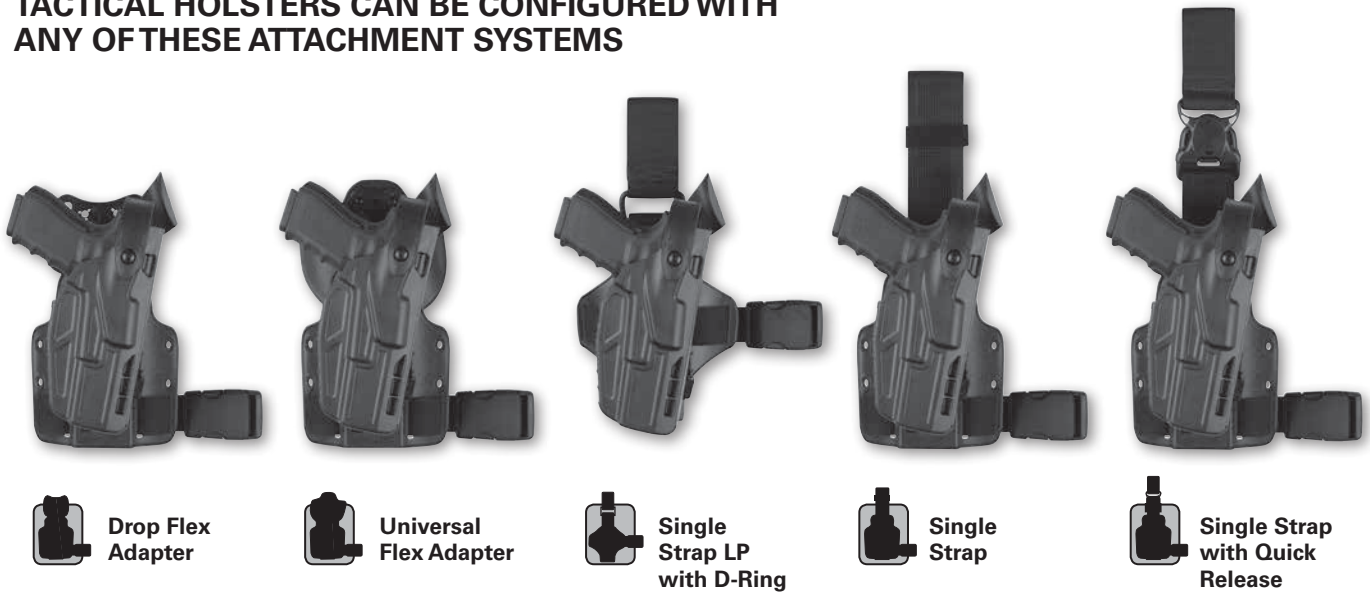

Safariland® tactical gear is a breed apart. Safariland products are battle-proven worldwide and offer an unmatched combination of quality, functionality and versatility in every product that carries our name. From leg-drop holsters and MOLLE-compatible attachment systems, to munitions carriers and more, Safariland gives you the tactical advantage you need – day in and day out.

All tactical holster models feature a double strap leg shroud with mounting holster for optional accessories

A complete list of mounting options and how to order, begins on page 168.

All holsters available in STX Tactical® finishes (all colors) unless noted

COLORS AVAILABLE

STX TACTICAL®

- COYOTE BROWN
- FDE BROWN
- FOLIAGE GREEN
- OD GREEN
- BLACK

7TS™

- FDE BROWN
- BLACK

Tactical Holsters

6004/6005 SLS TACTICAL HOLSTERS FOR: PISTOLS



6004



6005 W/QUICK RELEASE

FEATURES

- ▶ SLS allows for a smoother, single-motion draw and greater protection against attempted weapon takeaways
- ▶ Features the SLS (Self Locking System) rotating hood system
- ▶ Hood Guard is standard; optional Sentry available
- ▶ Thermal-molded SafariLaminate™ construction
- ▶ Standard double strap leg shroud with mounting holes for optional accessories
- ▶ Offered for weapons with and without rail mounted lights
- ▶ Suede lined to protect handgun's finish
- ▶ Leg strap features silicone strips for nonslip traction
- ▶ Available in STX Tactical® Black, Foliage Green, OD Green, Coyote Brown and FDE Brown finishes

A complete list of tactical accessories begins on page 161.

*Available In These Additional Finishes:	
Sample Code	6004-83-541
Foliage Green	6004-XX-54X
OD Green	6004-XX-56X
FDE Brown	6004-XX-55X
Coyote Brown	6004-XX-76X

How to Order
Duty Holsters
Duty Accessories
Tactical Holsters
Tactical Accessories
Duty Belts
QAS
Speed Loaders
Light Systems
Concealment Holsters
Concealment Accessories
Competition
Apparel
Sales Support
Index/Price List

Tactical Holsters

6004/6005 SLS TACTICAL HOLSTERS FOR: PISTOLS (continued)

	GUN DESCRIPTION	FINISH*	COLOR	6004		6005 W/QUICK RELEASE	
				RIGHT	LEFT	RIGHT	LEFT
How to Order							
Duty Holsters	AMT Hardballer 5" BBL	STX Tactical	Black	6004-53-121	6004-53-122	6005-53-121	6005-53-122
Duty Accessories	AMT Hardballer w/ SureFire 3V Light #310 5" BBL	STX Tactical	Black	6004-533-121	6004-533-122	6005-533-121	6005-533-122
Tactical Holsters	AMT Hardballer w/ SureFire 6V Light #610R 5" BBL	STX Tactical	Black	6004-536-121	6004-536-122	6005-536-121	6005-536-122
Tactical Accessories	Beretta 92F, 92FS, 92G, 96, 96G 4.9" BBL	STX Tactical	Black	6004-1373-121	6004-1373-122	6005-1373-121	6005-1373-122
	Beretta Px4 Storm 9mm, .40 4" BBL	STX Tactical	Black	6004-180-121	6004-180-122	6005-180-121	6005-180-122
Duty Belts	Beretta Px4 Storm 9mm, .40 w/ ITI M3/M6, TLR-1/TLR-2, Insight XT1 Procyon, SureFire X200/X300 Lights 4" BBL	STX Tactical	Black	6004-18021-121	6004-18021-122	6005-18021-121	6005-18021-122
OAS	Beretta 8000, 8040 Cougar G, F, 8045F 3.6" BBL	STX Tactical	Black	6004-71-121	6004-71-122	6005-71-121	6005-71-122
Speed Loaders	Beretta 84FS Cheetah 3.8" BBL	STX Tactical	Black	6004-62-121	6004-62-122	6005-62-121	6005-62-122
Light Systems	Beretta 92 Brigadier FS, 96 Brigadier, 96 Brigadier G, 92F, 92FS, 92G, 96, 96G 4.9" BBL 92FC, 92FCM, 92FS Centurion, 96 CenturionN/A for DA only 4.3" BBL	STX Tactical	Black	6004-73-121	6004-73-122	6005-73-121	6005-73-122
Concealment Holsters	Beretta 92D, 92DS, 92DM, 96D, 96DS, Brigadier D 4.9" BBL 96DC, 92FCDA Double Action only-Spurless Hammer 4.25" BBL	STX Tactical	Black	6004-173-121	6004-173-122	6005-173-121	6005-173-122
Concealment Accessories	Beretta 92 Brigadier FS, 96 Brigadier, 96 Brigadier G, 92F, 92FS, 92G, 96, 96G 4.9" BBL 92FC, 92FCM, 92FS Centurion, 96 Centurion w/ SureFire 3V LIGHT, Classic #333 N/A for DA only 4.3" BBL	STX Tactical	Black	6004-733-121	6004-733-122	6005-733-121	6005-733-122
Competition	Beretta 92F, 92 Brigadier, w/ SureFire Polymer Light, P116C, P116D, P116 4.9" BBL	STX Tactical	Black	6004-736-121	6004-736-122	6005-736-121	6005-736-122
Apparel	Beretta 92D, 92DS, 92DM, 96D, 96DS, Brigadier D, w/ SureFire 6V Light, #633R DAO 4.9" BBL	STX Tactical	Black	6004-1731-121	6004-1731-122	6005-1731-121	6005-1731-122
Sales Support	Beretta 92 Brigadier FS, 96 Brigadier, 96 Brigadier G, 92F, 92FS, 92G, 96, 96G, 4.9" BBL 92FC, 92FCM, 92FS Centurion; 96 Centurion w/ SureFire 6V Light, #633RN/A for DA only 4.3" BBL	STX Tactical	Black	6004-731-121	6004-731-122	6005-731-121	6005-731-122
Index/ Price List							

Tactical Holsters

6004/6005 SLS TACTICAL HOLSTERS FOR: PISTOLS (continued)

GUN DESCRIPTION	FINISH*	COLOR	6004		6005 W/QUICK RELEASE	
			RIGHT	LEFT	RIGHT	LEFT
Beretta 92, 96 Vertec w/ ITI M3/M6 4.7" BBL	STX Tactical	Black	6004-73421-121	6004-73421-122	6005-73421-121	6005-73421-122
Beretta 92, 96 Vertec w/ SureFire Nitrolon P001 Light N/A For DA w/ Bobbed Hammer 4.7" BBL	STX Tactical	Black	6004-7346-121	6004-7346-122	6005-7346-121	6005-7346-122
Beretta 92F, w/ ITI M3X 4.9" BBL	STX Tactical	Black	6004-7311-121	6004-7311-122	6005-7311-121	6005-7311-122
Beretta 92, 96 Vertec w/ ITI M3/M6 4.7" BBL	STX Tactical	Black	6004-73421-121	6004-73421-122	6005-73421-121	6005-73421-122
Beretta 92F, w/ ITI Mount M3/M6 4.9" BBL	STX Tactical	Black	6004-7321-121	6004-7321-122	6005-7321-121	6005-7321-122
Beretta 92F, w/ ITI Mount ILWLP Module 4.9" BBL	STX Tactical	Black	6004-7355-121	6004-7355-122	6005-7355-121	6005-7355-122
Browning Hi-Power 9mm 4.625" BBL	STX Tactical	Black	6004-76-121	6004-76-122	6005-76-121	6005-76-122
Browning Hi-Power Canadian Version 4" BBL	STX Tactical	Black	6004-376-121	6004-376-122	6005-376-121	6005-376-122
Browning Hi-Power 9mm Note: To be carried w/ the Hammer Down 4.625" BBL	STX Tactical	Black	6004-1376-121	6004-1376-122	6005-1376-121	6005-1376-122
Caspian 1911 w/ M6X,TLI and Military Mount 5" BBL	STX Tactical	Black	6004-5322-121	6004-5322-122	6005-5322-121	6005-5322-122
Caspian 1911 w/ SureFire 6V Light System, DP037 w/ Dawson Light Adapter 5" BBL	STX Tactical	Black	6004-538-121	6004-538-122	6005-538-121	6005-538-122
Colt Combat Elite, Combat Target Delta Elite, Delta Gold Cup, Gold Cup Nat'l Match, Government 1911, 1991-A1 5" BBL	STX Tactical	Black	6004-53-121	6004-53-122	6005-53-121	6005-53-122
Colt 1911-A1 Non Rail, w/ SureFire Mount MR07, w/ SureFire X200/X300/X300U X300/X300U 5" BBL	STX Tactical	Black	6004-530-121	6004-530-122	6005-530-121	6005-530-122
Colt Combat Elite, Combat Target, Delta Elite, Delta Gold Cup, Gold Cup Nat'l Match, 1911 w/ SureFire 3V Light, #310 5" BBL	STX Tactical	Black	6004-533-121	6004-533-122	6005-533-121	6005-533-122
Colt Combat Elite, Delta Elite, Delta Gold Cup, Gold Cup Nat'l Match, Government 1911 w/ SureFire 6V Light, #610R 5" BBL	STX Tactical	Black	6004-536-121	6004-536-122	6005-536-121	6005-536-122
Colt M45A1 CQBP 5" BBL	STX Tactical	Black	6004-056-121	6004-056-122	6005-056-121	6005-056-122
CZ 75B 4.5" BBL	STX Tactical	Black	6004-90-121	6004-90-122	6005-90-121	6005-90-122
CZ P07 w/ ITI M3, TLR-1, SureFire X200/X300 3.8" BBL	STX Tactical	Black	6004-7832-121	6004-7832-122	6005-7832-121	6005-7832-122

How to Order
Duty Holsters
Duty Accessories
Tactical Holsters
Tactical Accessories
Duty Belts
QAS
Speed Loaders
Light Systems
Concealment Holsters
Concealment Accessories
Competition
Apparel
Sales Support
Index/ Price List

Tactical Holsters

6004/6005 SLS TACTICAL HOLSTERS FOR: PISTOLS (continued)

How to Order	Duty Holsters	GUN DESCRIPTION	FINISH*	COLOR	6004		6005 W/QUICK RELEASE	
					RIGHT	LEFT	RIGHT	LEFT
		FN FNP 9mm 4" BBL	STX Tactical	Black	6004-260-121	6004-260-122	6005-260-121	6005-260-122
		FN FNP, .45 4.5" BBL	STX Tactical	Black	6004-261-121	6004-261-122	6005-261-121	6005-261-122
		FN FNS 9mm, .40 4" BBL	STX Tactical	Black	6004-266-121	6004-266-122	6005-266-121	6005-266-122
		FN FNX 9mm, .40 4" BBL	STX Tactical	Black	6004-265-121	6004-265-122	6005-265-121	6005-265-122
		FN Five-Seven 4.8" BBL	STX Tactical	Black	6004-61-121	6004-61-122	6005-61-121	6005-61-122
		FN Five-Seven w/ ITI Light M3/M6 (N/A for M3X/M6X) 4.8" BBL	STX Tactical	Black	6004-6121-121	6004-6121-122	6005-6121-121	6005-6121-122
		Glock 17, 22 4.5" BBL	STX Tactical	Black	6004-83-121	6004-83-122	6005-83-121	6005-83-122
		Glock 17, 22, w/ Dual Magazine Release 4.5" BBL	STX Tactical	Black	6004-983-121	6004-983-122	6005-983-121	6005-983-122
		Glock 17, 22, w/ ITI LAM Unit 4.5" BBL	STX Tactical	Black	6004-835-121	6004-835-122	6005-835-121	6005-835-122
		Glock 17, 22, w/ SureFire X200/X300/X300U 4.5" BBL	STX Tactical	Black	6004-836-121	6004-836-122	6005-836-121	6005-836-122
		Glock 17, 22 w/ SureFire P111, P111C, P111D, w/ Trigger Guard Rail Mount 4.5" BBL	STX Tactical	Black	6004-830-121	6004-830-122	6005-830-121	6005-830-122
		Glock 17, 22 4.5" BBL 19, 23, w/ SureFire 6V Light, #644AR 4" BBL	STX Tactical	Black	6004-831-121	6004-831-122	6005-831-121	6005-831-122
		Glock 17, 22 w/ Öerlikon Lam LLM-01 Module 4.5" BBL	STX Tactical	Black	6004-834-121	6004-834-122	6005-834-121	6005-834-122
		Glock 17, 22, w/ GTL 10 Light Only GTL 21/22 Light/Laser Combination GTL 51/52 Light/Laser Combination 4.5" BBL	STX Tactical	Black	6004-8310-121	6004-8310-122	6005-8310-121	6005-8310-122
		Glock 17, 22, 31 w/ ITI M3/M6, TLR-1, TLR-1HL, TLR-2, TLR-2HL 4.5" BBL	STX Tactical	Black	6004-8312-121	6004-8312-122	6005-8312-121	6005-8312-122
		Glock 17, 22, w/ ITI M3 4.5" BBL	STX Tactical	Black	6004-832-121	6004-832-122	6005-832-121	6005-832-122
		Glock 17, 22, w/ ITI M3/M6, TLR-1, TLR-2 4.5" BBL	STX Tactical	Black	6004-8321-121	6004-8321-122	6005-8321-121	6005-8321-122
		Glock 17, 22, w/ Dual Magazine Release w/ ITI M3 Light, TLR-1 4.5" BBL	STX Tactical	Black	6004-9832-121	6004-9832-122	6005-9832-121	6005-9832-122
		Glock 17, 22, w/ Dual Magazine Release GTL10 Light Only GTL 21/22 Light/Laser Combination GTL 51/52 Light/Laser Combination 4.5" BBL	STX Tactical	Black	6004-98310-121	6004-98310-122	6005-98310-121	6005-98310-122

Tactical Holsters

6004/6005 SLS TACTICAL HOLSTERS FOR: PISTOLS (continued)

GUN DESCRIPTION	FINISH*	COLOR	6004		6005 W/QUICK RELEASE	
			RIGHT	LEFT	RIGHT	LEFT
Glock 17, 22, w/ SureFire X400/X400U 4.5" BBL	STX Tactical	Black	6004-8314-121	6004-8314-122	6005-8314-121	6005-8314-122
Glock 19, 23 4" BBL 26, 27 3.5" BBL 36 3.75" BBL	STX Tactical	Black	6004-283-121	6004-283-122	6005-283-121	6005-283-122
Glock 19 23 w/ Dual Magazine Release 4" BBL	STX Tactical	Black	6004-9283-121	6004-9283-122	6005-9283-121	6005-9283-122
Glock 19,19C, 23, 23C, 25, 32 w/ ITI M3 4" BBL	STX Tactical	Black	6004-2832-121	6004-2832-122	6005-2832-121	6005-2832-122
Glock 19, 23 w/ SureFire X400 4" BBL	STX Tactical	Black	6004-8314-121	6004-8314-122	6005-8314-121	6005-8314-122
Glock 20, 21 4.6" BBL	STX Tactical	Black	6004-383-121	6004-383-122	6005-383-121	6005-383-122
Glock 20, 21 w/ SureFire X200/X300 4.6" BBL	STX Tactical	Black	6004-3830-121	6004-3830-122	6005-3830-121	6005-3830-122
Glock 20, 21 w/ SureFire 6V Light, #645AR 4.6" BBL	STX Tactical	Black	6004-3831-121	6004-3831-122	6005-3831-121	6005-3831-122
Glock 20, 21 w/ SureFire 9V Light, M111, M111C, M111D 4.6" BBL	STX Tactical	Black	6004-3839-121	6004-3839-122	6005-3839-121	6005-3839-122
Glock 20, 21 w/ ITI M3/M6 4.5" BBL	STX Tactical	Black	6004-38321-121	6004-38321-122	6005-38321-121	6005-38321-122
Glock 20, 21 w/ ITI M3 4.5" BBL	STX Tactical	Black	6004-3832-121	6004-3832-122	6005-3832-121	6005-3832-122
Glock 20 & 21SF w/ Dual Magazine Release w/ ITI M3/M6, TLR-1/TLR-2, Insight XTI Procyon, SureFire X200/X300/X300U 4.6" BBL	STX Tactical	Black	6004-938321-121	6004-938321-122	6005-938321-121	6005-938321-122
Glock 34, 35 5.3" BBL	STX Tactical	Black	6004-683-121	6004-683-122	6005-683-121	6005-683-122
Glock 34, 35 w/ ITI M3 5.3" BBL	STX Tactical	Black	6004-6832-121	6004-6832-122	6005-6832-121	6005-6832-122
Glock 34, 35 w/ ITI M3/M6 (N/A for M3X/M6X) 5.3" BBL	STX Tactical	Black	6004-68321-121	6004-68321-122	6005-68321-121	6005-68321-122
Glock 37 4.5" BBL 38 4" BBL	STX Tactical	Black	6004-783-121	6004-783-122	6005-783-121	6005-783-122
Glock 37 w/ ITI M3, TLR-1, TLR-1HL, Insight XTI Procyon, SureFire X200/X300 4.5" BBL	STX Tactical	Black	6004-7832-121	6004-7832-122	6005-7832-121	6005-7832-122

How to Order
Duty Holsters
Duty Accessories
Tactical Holsters
Tactical Accessories
Duty Belts
QAS
Speed Loaders
Light Systems
Concealment Holsters
Concealment Accessories
Competition
Apparel
Sales Support
Index/ Price List

Tactical Holsters

6004/6005 SLS TACTICAL HOLSTERS FOR: PISTOLS (continued)

	GUN DESCRIPTION	FINISH*	COLOR	6004		6005 W/QUICK RELEASE	
				RIGHT	LEFT	RIGHT	LEFT
Duty Holsters	Heckler & Koch P30 3.875" BBL	STX Tactical	Black	6004-295-121	6004-295-122	6005-295-121	6005-295-122
Duty Accessories	Heckler & Koch P30L, w/ ITI M3X/M6X 4.44" BBL	STX Tactical	Black	6004-39512-121	6004-39512-122	6005-39512-121	6005-39512-122
Tactical Holsters	Heckler & Koch P7, P7 M8, M13 4.1" BBL	STX Tactical	Black	6004-82-121	6004-82-122	6005-82-121	6005-82-122
Tactical Accessories	Heckler & Koch USP 9C Cocked & Locked w/ SureFire Mount and SureFire X200/X300/X300U 3.58" BBL	STX Tactical	Black	6004-2910-121	6004-2910-122	6005-2910-121	6005-2910-122
Duty Belts	Heckler & Koch USP 9C, 40C, (w/Bobbed Hammer) US version only 4.25" BBL	STX Tactical	Black	6004-291-121	6004-291-122	6005-291-121	6005-291-122
OAS	Heckler & Koch USP 9mm, .40 4.13" BBL USP .45 Cocked & Locked Only 4.41" BBL	STX Tactical	Black	6004-92-121	6004-92-122	6005-92-121	6005-92-122
Speed Loaders	Heckler & Koch USP 9mm, .40 4.13" BBL USP .45, (w/ Bobbed Hammer) 4.41" BBL	STX Tactical	Black	6004-193-121	6004-193-122	6005-193-121	6005-193-122
Light Systems	Heckler & Koch USP 9mm, .40 DAO w/ SureFire Mount w/ ITI M3X/M6X Light 4.13" BBL	STX Tactical	Black	6004-19312-121	6004-19312-122	6005-19312-121	6005-19312-122
Concealment Holsters	Heckler & Koch USP 9mm DAO w/ SureFire Mount P105, P115 SureFire Bobbed Hammer 4.13" BBL	STX Tactical	Black	6004-1936-121	6004-1936-122	6005-1936-121	6005-1936-122
Concealment Accessories	Heckler & Koch USP 9mm, .40 Hammer Down or Cocked & Locked w/ B&T Adapter ITI Tactical Light M3, M6 and M3 LED 4.13" BBL	STX Tactical	Black	6004-9221-121	6004-9221-122	6005-9221-121	6005-9221-122
Competition	Heckler & Koch USP 9mm, .40 w/ LAS/TAC 6V 4.13" BBL	STX Tactical	Black	6004-917-121	6004-917-122	6005-917-121	6005-917-122
Apparel	Heckler & Koch USP 9mm, .40 4.13" BBL USP .45 w/ H&K USP Light Cocked and Locked Only 4.41" BBL	STX Tactical	Black	6004-918-121	6004-918-122	6005-918-121	6005-918-122
Sales Support	Heckler & Koch USP 9mm, .40 w/ LAS/TAC 6V 4.13" BBL USP .45 Variant 1, 2, 3, 4, 5, 6, 7, 8, 9, 10 w/ SureFire 6V Light Classic #609R 4.41" BBL	STX Tactical	Black	6004-922-121	6004-922-122	6005-922-121	6005-922-122
Index/Price List	Heckler & Koch USP 9mm, .40 4.13" BBL USP .45, w/ H&K USP Light Hammer Down, N/A For DA only 4.41" BBL	STX Tactical	Black	6004-931-121	6004-931-122	6005-931-121	6005-931-122
	Heckler & Koch USP 9mm, .40 4.13" BBL USP .45, w/ H&K USP Light Hammer Down, N/A For DA only 4.41" BBL	STX Tactical	Black	6004-932-121	6004-932-122	6005-932-121	6005-932-122

Tactical Holsters

6004/6005 SLS TACTICAL HOLSTERS FOR: PISTOLS (continued)

GUN DESCRIPTION	FINISH*	COLOR	6004		6005 W/QUICK RELEASE	
			RIGHT	LEFT	RIGHT	LEFT
Heckler & Koch USP 9mm, .40 4.13" BBL USP .45, w/ H&K USP Light w/ Bobbed Hammer 4.41" BBL	STX Tactical	Black	6004-1932-121	6004-1932-122	6005-1932-121	6005-1932-122
Heckler & Koch USP 9mm, .40 Cocked & Locked w/ LAM Unit 4.13" BBL	STX Tactical	Black	6004-191-121	6004-191-122	6005-191-121	6005-191-122
Heckler & Koch USP 9mm, .40 Hammer Down 4.13" BBL USP .45 Hammer Down N/A for DA Only 4.41" BBL	STX Tactical	Black	6004-93-121	6004-93-122	6005-93-121	6005-93-122
Heckler & Koch USP 9mm, .40 Hammer Down w/ SureFire X200/ X300/X300U, Streamlight M3, M6, TLR-1, TLR-2 Insight XTI Procyon 4.13" BBL USP .45 Hammer Down w/ SureFire X200/ X300/X300U, Streamlight M3/M6, TLR-1, TLR-2 Insight XTI Procyon 4.41" BBL	STX Tactical	Black	6004-9321-121	6004-9321-122	6005-9321-121	6005-9321-122
Heckler & Koch USP .40 Expert 5.2" BBL	STX Tactical	Black	6004-96-121	6004-96-122	6005-96-121	6005-96-122
Heckler & Koch USP 40C w/ Light Adapter, ITI M3/M6, M3X (N/A for M6X) 4.25" BBL	STX Tactical	Black	6004-29111-121	6004-29111-122	6005-29111-121	6005-29111-122
Heckler & Koch USP 45C w/ Bobbed Hammer, USP 9C, 40C w/ Spurred Hammer 3.8" BBL	STX Tactical	Black	6004-293-121	6004-293-122	6005-293-121	6005-293-122
Heckler & Koch HK .45 Cocked & Locked TLR-1, SureFire X200/X300/X300U 4.53" BBL	STX Tactical	Black	6004-3930-121	6004-3930-122	6005-3930-121	6005-3930-122
Heckler & Koch USP .45, LEM (DAO) w/ Bobbed Hammer w/ Spurred Hammer, SureFire MR09 Light Adapter and SureFire X200/X300/X300U 4.41" BBL	STX Tactical	Black	6004-930-121	6004-930-122	6005-930-121	6005-930-122
Heckler & Koch HK .45 4.53" BBL	STX Tactical	Black	6004-393-121	6004-393-122	6005-393-121	6005-393-122
Heckler & Koch P30L9/40 w/ ITI M3, TLR-1, SureFire X200/X300/X300U 4.45" BBL	STX Tactical	Black	6004-3952-121	6004-3952-122	6005-3952-121	6005-3952-122
Heckler & Koch P2000 3.5" BBL	STX Tactical	Black	6004-97-121	6004-97-122	6005-97-121	6005-97-122
Heckler & Koch P2000, DAO Bobbed Hammer w/ B&T Adapter and Glock Light Systems GTL 10 Light Only GTL 21/22 Light/Laser Combination GTL 51/52 Light/Laser Combination 3.5" BBL	STX Tactical	Black	6004-9710-121	6004-9710-122	6005-9710-121	6005-9710-122
Heckler & Koch P2000, DAO USA Version, w/ M3X Light, Bobbed Hammer 3.66" BBL	STX Tactical	Black	6004-9711-121	6004-9711-122	6005-9711-121	6005-9711-122

How to Order
Duty Holsters
Duty Accessories
Tactical Holsters
Tactical Accessories
Duty Belts
QAS
Speed Loaders
Light Systems
Concealment Holsters
Concealment Accessories
Competition
Apparel
Sales Support
Index/ Price List

Tactical Holsters

6004/6005 SLS TACTICAL HOLSTERS FOR: PISTOLS (continued)

How to Order	Duty Holsters	GUN DESCRIPTION	FINISH*	COLOR	6004		6005 W/QUICK RELEASE	
					RIGHT	LEFT	RIGHT	LEFT
		Heckler & Koch P2000 European Version w/ B&T Adapter (TL P2000) w/ ITI M3/M6 Holster will not retain weapon w/o light attached, 3.5" BBL	STX Tactical	Black	6004-9721-121	6004-9721-122	6005-9721-121	6005-9721-122
		Heckler & Koch P2000 US Version, w/ ITI M3/M6 3.5" BBL	STX Tactical	Black	6004-19721-121	6004-19721-122	6005-19721-121	6005-19721-122
		Heckler & Koch MK-23, .45 ACP 5.87" BBL	STX Tactical	Black	6004-94-121	6004-94-122	6005-94-121	6005-94-122
		Kimber Classic Custom, KIP45CUS 5" BBL	STX Tactical	Black	6004-53-121	6004-53-122	6005-53-121	6005-53-122
		Kimber Classic Custom, Custom Royal, Gold Match w/ SureFire 3V Light #310 5" BBL	STX Tactical	Black	6004-533-121	6004-533-122	6005-533-121	6005-533-122
		Kimber Gold Combat RL Custom TLE/RL w/ SureFire X200 5" BBL	STX Tactical	Black	6004-5340-121	6004-5340-122	6005-5340-121	6005-5340-122
		Para-Ordnance P14, P16 5" BBL	STX Tactical	Black	6004-53-121	6004-53-122	6005-53-121	6005-53-122
		Para-Ordnance P14, w/ SureFire 3V Light #310 5" BBL	STX Tactical	Black	6004-533-121	6004-533-122	6005-533-121	6005-533-122
		Para-Ordnance P14 w/ SureFire 6V Light #610 5" BBL	STX Tactical	Black	6004-536-121	6004-536-122	6005-536-121	6005-536-122
		Sig Sauer P220, P226, P226R MK25 4.41" BBL	STX Tactical	Black	6004-77-121	6004-77-122	6005-77-121	6005-77-122
		Sig Sauer P220R DAK, P226R DAK (w/ Bobbed Hammer) 4.41" BBL	STX Tactical	Black	6004-277-121	6004-277-122	6005-277-121	6005-277-122
		Sig Sauer P220, P226 w/ ITI Mount and M3X/M6X 4.41" BBL	STX Tactical	Black	6004-7712-121	6004-7712-122	6005-7712-121	6005-7712-122
		Sig Sauer P220R DAK, P226R DAK w/ Bobbed Hammer w/ ITI M3/M6 Light 4.41" BBL	STX Tactical	Black	6004-27721-121	6004-27721-122	6005-27721-121	6005-27721-122
		Sig Sauer P220, P226 w/ LASER Light by LASER DEVICES 6V, 3V LAS/TAC Light Laser Housing 3A Pistol Laser 4.41" BBL	STX Tactical	Black	6004-772-121	6004-772-122	6005-772-121	6005-772-122
		Sig Sauer P220R DAK, P226R DAK Bobbed Hammer w/ SureFire X200 4.41" BBL	STX Tactical	Black	6004-2770-121	6004-2770-122	6005-2770-121	6005-2770-122
		Sig Sauer P220, P226 Full Size Hammer w/ ITI Light Mount, ITI M3/M6 4.41" BBL	STX Tactical	Black	6004-7721-121	6004-7721-122	6005-7721-121	6005-7721-122

Tactical Holsters

6004/6005 SLS TACTICAL HOLSTERS FOR: PISTOLS (continued)

GUN DESCRIPTION	FINISH*	COLOR	6004		6005 W/QUICK RELEASE	
			RIGHT	LEFT	RIGHT	LEFT
Sig Sauer P220R, P226R w/ SureFire X400/X400U 4.41" BBL	STX Tactical	Black	6004-77414-131	6004-77414-132	6005-77414-131	6005-77414-132
Sig Sauer P220R, P220S, P226S, P226SO, P226R w/ ITI M3/M6 w/ Accessory Rails 4.41" BBL	STX Tactical	Black	6004-77421-121	6004-77421-122	6005-77421-121	6005-77421-122
Sig Sauer P220R, P226R w/ ITI M3X/M6X 4.41" BBL	STX Tactical	Black	6004-77412-121	6004-77412-122	6005-77412-121	6005-77412-122
Sig Sauer P220, P226 w/ SureFire 3V Light Classic System #314, #332 4.41" BBL	STX Tactical	Black	6004-773-121	6004-773-122	6005-773-121	6005-773-122
Sig Sauer P220SO, P220ST, P220R, P226R w/ SureFire X200 4.41" BBL	STX Tactical	Black	6004-7740-121	6004-7740-122	6005-7740-121	6005-7740-122
Sig Sauer P220R, P220S, P226S, P226SO, P226R w/ SureFire Nitrulon Polymer Light Model: P004 w/ Accessory Rails 4.41" BBL	STX Tactical	Black	6004-7746-121	6004-7746-122	6005-7746-121	6005-7746-122
Sig Sauer P220, P226 w/ SureFire Nitrulon Polymer Light P114C, P114D, P113, P113C, P113D 4.41" BBL	STX Tactical	Black	6004-776-121	6004-776-122	6005-776-121	6005-776-122
Sig Sauer P220, P226 w/ SureFire Military Light W113C, W113D, W113, W114C, W114D, W114 4.41" BBL	STX Tactical	Black	6004-778-121	6004-778-122	6005-778-121	6005-778-122
Sig Sauer P220, P226 w/ SureFire 6V Light Classic System #614R, #632R 4.41" BBL	STX Tactical	Black	6004-771-121	6004-771-122	6005-771-121	6005-771-122
Sig Sauer P220R, P226R w/ MOLAD Light Laser 4.41" BBL	STX Tactical	Black	6004-77413-121	6004-77413-122	6005-77413-121	6005-77413-122
Sig Sauer P226 w/ SureFire MR14 Rail & SureFire X200/X300 4.41" BBL	STX Tactical	Black	6004-7700-121	6004-7700-122	6005-7700-121	6005-7700-122
Sig Sauer P226 w/ ITI Lam Unit 4.41" BBL	STX Tactical	Black	6004-775-121	6004-775-122	6005-775-121	6005-775-122
Sig Sauer P226 w/ SureFire Millennium Light M114C, M114D, M114 4.41" BBL	STX Tactical	Black	6004-779-121	6004-779-122	6005-779-121	6005-779-122
Sig Sauer P226R, X-Five w/ SureFire X200/X300 5" BBL	STX Tactical	Black	6004-3770-121	6004-3770-122	6005-3770-121	6005-3770-122
Sig Sauer P227 4.4" BBL	STX Tactical	Black	6004-77-121	6004-77-122	6005-77-121	6005-77-122

How to Order
Duty Holsters
Duty Accessories
Tactical Holsters
Tactical Accessories
Duty Belts
QAS
Speed Loaders
Light Systems
Concealment Holsters
Concealment Accessories
Competition
Apparel
Sales Support
Index/ Price List

Tactical Holsters

6004/6005 SLS TACTICAL HOLSTERS FOR: PISTOLS (continued)

How to Order	Duty Holsters	GUN DESCRIPTION	FINISH*	COLOR	6004		6005 W/QUICK RELEASE	
					RIGHT	LEFT	RIGHT	LEFT
Duty Accessories		Sig Sauer P225, P228, P229, P229R 3.9" BBL P220R Compact 3.75" BBL	STX Tactical	Black	6004-74-121	6004-74-122	6005-74-121	6005-74-122
Tactical Holsters		Sig Sauer P225, P228, P229 w/ SureFire 6V Light Classic System #640R 3.86" BBL	STX Tactical	Black	6004-741-121	6004-741-122	6005-741-121	6005-741-122
Tactical Accessories		Sig Sauer P229R DAK w/ Bobbed Hammer w/ SureFire X200/X300 3.9" BBL	STX Tactical	Black	6004-1740-121	6004-1740-122	6005-1740-121	6005-1740-122
Duty Belts		Sig Sauer P229R DAK DAO w/ Bobbed Hammer 3.9" BBL	STX Tactical	Black	6004-174-121	6004-174-122	6005-174-121	6005-174-122
OAS		Sig Sauer P229 w/ ITI Mount and ITI M3X Light 3.86" BBL	STX Tactical	Black	6004-7411-121	6004-7411-122	6005-7411-121	6005-7411-122
Speed Loaders		Sig Sauer P229R DAK w/ Light Rails Bobbed Hammer w/ ITI M3/M6 and M3 LED 3.9" BBL	STX Tactical	Black	6004-17421-121	6004-17421-122	6005-17421-121	6005-17421-122
Light Systems		Sig Sauer P229R DAK Bobbed Hammer w/ ITI M3X/M6X Light Holster will not retain handgun w/o light attached 3.9" BBL	STX Tactical	Black	6004-17412-121	6004-17412-122	6005-17412-121	6005-17412-122
Concealment Holsters		Sig Sauer P229R w/ Accessory Rail, DA/SA (Spurred Hammer) w/ ITI Light M3/M6 (N/A for M3X/M6X) 3.9" BBL	STX Tactical	Black	6004-74421-121	6004-74421-122	6005-74421-121	6005-74421-122
Concealment Accessories		Sig Sauer P228, P229 w/ ITI Mount and ITI M3/M6 3.86" BBL	STX Tactical	Black	6004-7421-121	6004-7421-122	6005-7421-121	6005-7421-122
Competition		Sig Sauer P250 9mm, .40 4.7" BBL	STX Tactical	Black	6004-450-121	6004-450-122	6005-450-121	6005-450-122
Apparel		Sig Sauer P250 Compact, 9mm, .40, .45 3.9" BBL	STX Tactical	Black	6004-750-121	6004-750-122	6005-750-121	6005-750-122
Sales Support		Sig Sauer 1911 GSR Revolution w/ & w/o Light Rails 5" BBL	STX Tactical	Black	6004-256-121	6004-256-122	6005-256-121	6005-256-122
Index/Price List		Sig Sauer 1911 GSR, w/ ITI M3/M6, Streamlight TLR-1/TLR-2 & SureFire X200/X300, SSL-1 5" BBL	STX Tactical	Black	6004-25621-121	6004-25621-122	6005-25621-121	6005-25621-122
		Sig Sauer Sig Pro P2022 w/ ITI M3/M6 3.5" BBL	STX Tactical	Black	6004-27821-121	6004-27821-122	6005-27821-121	6005-27821-122
		Sig Sauer Sig Pro SP2340 3.875" BBL	STX Tactical	Black	6004-78-121	6004-78-122	6005-78-121	6005-78-122
		Sig Sauer Sig Pro SP2340 LDI LASER 20871 or LDI LASER 20872 3.875" BBL	STX Tactical	Black	6004-782-121	6004-782-122	6005-782-121	6005-782-122

Tactical Holsters

6004/6005 SLS TACTICAL HOLSTERS FOR: PISTOLS (continued)

GUN DESCRIPTION	FINISH*	COLOR	6004		6005 W/QUICK RELEASE	
			RIGHT	LEFT	RIGHT	LEFT
Sig Sauer Sig Pro SPC2009 w/ Light Mount Rail 3.5" BBL	STX Tactical	Black	6004-278-121	6004-278-122	6005-278-121	6005-278-122
Smith & Wesson Sigma 9C, Sigma 40C 4" BBL	STX Tactical	Black	6004-39-121	6004-39-122	6005-39-121	6005-39-122
Smith & Wesson Sigma 9F, Sigma 40F 4.5" BBL	STX Tactical	Black	6004-40-121	6004-40-122	6005-40-121	6005-40-122
Smith & Wesson M&P 9L 5" BBL	STX Tactical	Black	6004-819-121	6004-819-122	6005-819-121	6005-819-122
Smith & Wesson M&P 9mm, .40 w/ SureFire X200/X300/X300U 4.25" BBL	STX Tactical	Black	6004-2190-121	6004-2190-122	6005-2190-121	6005-2190-122
Smith & Wesson 4006, 4043 4046, 5903, 5904, 5906, 5946, 4006TSW, 4046TSW, 5906TSW, 5946TSW All w/ full size serrated hammer short round trigger guard w/ Light Rails 4" BBL	STX Tactical	Black	6004-140-121	6004-140-122	6005-140-121	6005-140-122
Smith & Wesson 4006TSW, w/ Bolt on S & W Light Rail 4006TSW, w/ Picatinny Light Rail Bobbed Hammer 4" BBL	STX Tactical	Black	6004-141-121	6004-141-122	6005-141-121	6005-141-122
Smith & Wesson 5906TSW, 5946TSW, 4006TSW, 4046TSW w/ Rails w/ ITI M5 All w/ full size serrated hammer short round trigger guard 4" BBL	STX Tactical	Black	6004-1402-121	6004-1402-122	6005-1402-121	6005-1402-122
Smith & Wesson 5906 w/ Bobbed Hammer 4" BBL	STX Tactical	Black	6004-418-121	6004-418-122	6005-418-121	6005-418-122
Smith & Wesson 6904, 6906, 6924, 6926 4013TSW 3.5" BBL	STX Tactical	Black	6004-20-121	6004-20-122	6005-20-121	6005-20-122
Smith & Wesson 645, 1006, 4506-1, 4506, 4566, 4563TSW, 4566TSW 4.25" BBL	STX Tactical	Black	6004-210-121	6004-210-122	6005-210-121	6005-210-122
Smith & Wesson M&P 9C, 40C w/ Thumb Safety 3.375" BBL	STX Tactical	Black	6004-719-121	6004-719-122	6005-719-121	6005-719-122
Smith & Wesson M&P 9mm, .40 w/o Thumb Safety 4.25" BBL	STX Tactical	Black	6004-219-121	6004-219-122	6005-219-121	6005-219-122
Smith & Wesson M&P 9mm, .40 w/ Thumb Safety 4.25" BBL	STX Tactical	Black	6004-619-121	6004-619-122	6005-619-121	6005-619-122
Smith & Wesson M&P 9mm, .40 w/ ITI M3/M6 TLR-1/TLR-2 4.25" BBL	STX Tactical	Black	6004-21921-121	6004-21921-122	6005-21921-121	6005-21921-122
Smith & Wesson M&P .45, w/ & w/o Safety 4.5" BBL	STX Tactical	Black	6004-519-121	6004-519-122	6005-519-121	6005-519-122

How to Order
Duty Holsters
Duty Accessories
Tactical Holsters
Tactical Accessories
Duty Belts
QAS
Speed Loaders
Light Systems
Concealment Holsters
Concealment Accessories
Competition
Apparel
Sales Support
Index/ Price List

Tactical Holsters

6004/6005 SLS TACTICAL HOLSTERS FOR: PISTOLS (continued)

How to Order	Duty Holsters	GUN DESCRIPTION	FINISH*	COLOR	6004		6005 W/QUICK RELEASE	
					RIGHT	LEFT	RIGHT	LEFT
Duty Accessories		Smith & Wesson M&P .45, w/ & w/o Safety w/ ITI M3/M6, TLR-1/TLR-2 SureFire X200/X300 4.5" BBL	STX Tactical	Black	6004-51921-121	6004-51921-122	6005-51921-121	6005-51921-122
Tactical Holsters		Smith & Wesson 1006 w/ SureFire 6V Light 4.25" BBL	STX Tactical	Black	6004-2101-121	6004-2101-122	6005-2101-121	6005-2101-122
Tactical Accessories		Smith & Wesson 4566TSW, w/ Light Rails & ITI M5 4.125" BBL	STX Tactical	Black	6004-4302-121	6004-4302-122	6005-4302-121	6005-4302-122
Duty Belts		Smith & Wesson SW99 4" BBL	STX Tactical	Black	6004-84-121	6004-84-122	6005-84-121	6005-84-122
OAS		Smith & Wesson SW99 .45ACP 4.25" BBL	STX Tactical	Black	6004-86-121	6004-86-122	6005-86-121	6005-86-122
Speed Loaders		Smith & Wesson SW99 w/ ITI M5 4" BBL	STX Tactical	Black	6004-842-121	6004-842-122	6005-842-121	6005-842-122
Light Systems		Sphinx Model 3000 Cocked & Locked or Hammer Down 3.75" BBL, 4.5" BBL	STX Tactical	Black	6004-182-121	6004-182-122	6005-182-121	6005-182-122
Concealment Holsters		Sphinx Model 3000 Hammer Down or Cocked & Locked w/ IT M3X/MX6 Light 3.75" BBL, 4.5" BBL	STX Tactical	Black	6004-18212-121	6004-18212-122	6005-18212-121	6005-18212-122
Concealment Accessories		Sphinx Model 3000 Cocked & Locked w/ ITI LAM Light 4.5" BBL, 3.75" BBL	STX Tactical	Black	6004-1825-121	6004-1825-122	6005-1825-121	6005-1825-122
Competition		Sphinx SDP w/ SureFire X400U 4.5" BBL	STX Tactical	Black	6004-28114-121	6004-28114-122	6005-28114-121	6005-28114-122
Apparel		Springfield Armory XD(M) 9mm 3.8" BBL	STX Tactical	Black	6004-148-121	6004-148-122	6005-148-121	6005-148-122
Sales Support		Springfield Armory XD, 9mm, .40, .357, .45 5" BBL	STX Tactical	Black	6004-149-121	6004-149-122	6005-149-121	6005-149-122
Index/ Price List		Springfield Armory XD, 9mm, .40, .45, w/ ITI M3/M6, TLR-1/TLR-2, SureFire X200/X300 4" BBL	STX Tactical	Black	6004-14821-121	6004-14821-122	6005-14821-121	6005-14821-122
		Springfield Armory XD(M), 9mm, .40, .45 4.1" BBL	STX Tactical	Black	6004-149-121	6004-149-122	6005-149-121	6005-149-122
		Springfield Armory XD 9mm, .40, .45, .357 w/ ITI M3/M6, TLR-1/TLR-2, Insight XTI Procyon, SureFire X200/ X300/X300U 5" BBL	STX Tactical	Black	6004-14921-121	6004-14921-122	6005-14921-121	6005-14921-122
		Springfield Armory Operator 1911-A1 5" BBL	STX Tactical	Black	6004-53-121	6004-53-122	6005-53-121	6005-53-122
		Springfield Armory Operator 1911-A1 w/ SureFire 3V Light Classic System #310 5" BBL	STX Tactical	Black	6004-533-121	6004-533-122	6005-533-121	6005-533-122

Tactical Holsters

6004/6005 SLS TACTICAL HOLSTERS FOR: PISTOLS (continued)

GUN DESCRIPTION	FINISH*	COLOR	6004		6005 W/QUICK RELEASE	
			RIGHT	LEFT	RIGHT	LEFT
Springfield Armory Operator 1911-A1 w/ SureFire 6V Light Classic System #610R 5" BBL	STX Tactical	Black	6004-536-121	6004-536-122	6005-536-121	6005-536-122
Springfield Armory Operator 1911-A1 Model PX9105L w/ Picatinny Light Rail 5" BBL	STX Tactical	Black	6004-56-121	6004-56-122	6005-56-121	6005-56-122
Springfield Armory Operator 1911-A1 w/ ITI M3X/M6X Light 5" BBL	STX Tactical	Black	6004-5612-121	6004-5612-122	6005-5612-121	6005-5612-122
Springfield Armory Operator 1911-A1 Model PX9105L w/ Picatinny Light Rail w/ ITI M6/M3 5" BBL	STX Tactical	Black	6004-5621-121	6004-5621-122	6005-5621-121	6005-5621-122
Stinger S-200	STX Tactical	Black	6004-164-121	6004-164-122	6005-164-121	6005-164-122
Tangfolio Force 4.4" BBL	STX Tactical	Black	6004-262-121	6004-262-122	6005-262-121	6005-262-122
Taser® Advanced Taser M26	STX Tactical	Black	6004-63-121	6004-63-122	6005-63-121	6005-63-122
Taser® X3	STX Tactical	Black	6004-163-121	6004-163-122	6005-163-121	6005-163-122
Taser® X26	STX Tactical	Black	6004-64-121	6004-64-122	6005-64-121	6005-64-122
Walther P99 BA-5 Laser w/ Optional Accessory Rail 4" BBL	STX Tactical	Black	6004-848-121	6004-848-122	6005-848-121	6005-848-122
Walther P99C QA 3.375" BBL	STX Tactical	Black	6004-84-121	6004-84-122	6005-84-121	6005-84-122
Walther PPQ 4" BBL	STX Tactical	Black	6004-384-121	6004-384-122	6005-384-121	6005-384-122
Wilson Combat 1911 3.375" BBL	STX Tactical	Black	6004-53-121	6004-53-122	6005-53-121	6005-53-122

SLS Hood Guard	Black	6000-1	6000-2
	Foliage Green	6000-541	6000-542
	Coyote Brown	6000-761	6000-762
	OD Green	6000-561	6000-562
	FDE Brown	6000-551	6000-552
SLS Sentry	Black	6001-1	6001-2
SLS Hood Guard/Sentry	Black	6002-1	6002-2
	Foliage Green	6002-541	6002-542
	Coyote Brown	6002-761	6002-762
	OD Green	6002-561	6002-562
	FDE Brown	6002-551	6002-552

How to Order
Duty Holsters
Duty Accessories
Tactical Holsters
Tactical Accessories
Duty Belts
QAS
Speed Loaders
Light Systems
Concealment Holsters
Concealment Accessories
Competition
Apparel
Sales Support
Index/Price List

Tactical Holsters

6004/6005 RDS SLS TACTICAL HOLSTERS FOR: PISTOLS



6004



6005 W/QUICK RELEASE



FEATURES

- ▶ SLS (Self Locking System) Rotating Hood, allows for a smoother, single-motion draw and greater protection against attempted weapon takeaways
- ▶ For use with red dot optic-equipped weapons
- ▶ Leg strap features silicone strips for nonslip traction
- ▶ SafariLaminate™ thermal-molded construction protects handgun and sights
- ▶ Suede lined to protect handgun's finish
- ▶ Available in Cordura®/Nylon, MultiCam®, Ranger Green, Coyote, Khaki, or Black finishes.
- ▶ Optic Hood Guard (optional)

A complete list of tactical accessories begins on page 161.

GUN DESCRIPTION	FINISH*	COLOR	6004RDS		6005RDS W/QUICK RELEASE	
			RIGHT	LEFT	RIGHT	LEFT
Glock 17/22 w/ ITI M3 Light, TLR-1, TLR-1HL, SureFire X200/X300/ X300U 4.5" BBL	Cordura® Cordura® Cordura® Cordura® Tactical	MultiCam® Ranger Green Coyote Khaki Black Black	6004RDS-832-701	6004RDS-832-702	6005RDS-832-701	6005RDS-832-702
			6004RDS-832-731	6004RDS-832-732	6005RDS-832-731	6005RDS-832-732
			6004RDS-832-741	6004RDS-832-742	6005RDS-832-741	6005RDS-832-742
			6004RDS-832-751	6004RDS-832-752	6005RDS-832-751	6005RDS-832-752
			6004RDS-832-781	6004RDS-832-782	6005RDS-832-781	6005RDS-832-782
6004RDS-832-131	6004RDS-832-132	6005RDS-832-131	6005RDS-832-132			
Glock 19/23 w/ITI M3 Light, TLR-1, TLR-1HL, SureFire X200/X300/ X300U 4" BBL	Cordura® Cordura® Cordura® Cordura® Tactical	MultiCam® Ranger Green Coyote Khaki Black Black	6004RDS-2832-701	6004RDS-2832-702	6005RDS-2832-701	6005RDS-2832-702
			6004RDS-2832-731	6004RDS-2832-732	6005RDS-2832-731	6005RDS-2832-732
			6004RDS-2832-741	6004RDS-2832-742	6005RDS-2832-741	6005RDS-2832-742
			6004RDS-2832-751	6004RDS-2832-752	6005RDS-2832-751	6005RDS-2832-752
			6004RDS-2832-781	6004RDS-2832-782	6005RDS-2832-781	6005RDS-2832-782
6004RDS-2832-131	6004RDS-2832-132	6005RDS-2832-131	6005RDS-2832-132			
Glock 34/35 w/ITI M3 Light, TLR-1, TLR-1HL, SureFire X200/X300/ X300U 5.32" BBL	Cordura® Cordura® Cordura® Cordura® Tactical	MultiCam® Ranger Green Coyote Khaki Black Black	6004RDS-6832-701	6004RDS-6832-702	6005RDS-6832-701	6005RDS-6832-702
			6004RDS-6832-731	6004RDS-6832-732	6005RDS-6832-731	6005RDS-6832-732
			6004RDS-6832-741	6004RDS-6832-742	6005RDS-6832-741	6005RDS-6832-742
			6004RDS-6832-751	6004RDS-6832-752	6005RDS-6832-751	6005RDS-6832-752
			6004RDS-6832-781	6004RDS-6832-782	6005RDS-6832-781	6005RDS-6832-782
6004RDS-6832-131	6004RDS-6832-132	6005RDS-6832-131	6005RDS-6832-132			
Smith & Wesson M&P 9mm, .40 w/ITI M3 Light, TLR-1, TLR-1HL, SureFire X200/X300/ X300U 4.25" BBL	Cordura® Cordura® Cordura® Cordura® Tactical	MultiCam® Ranger Green Coyote Khaki Black Black	6004RDS-2192-701	6004RDS-2192-702	6005RDS-2192-701	6005RDS-2192-702
			6004RDS-2192-731	6004RDS-2192-732	6005RDS-2192-731	6005RDS-2192-732
			6004RDS-2192-741	6004RDS-2192-742	6005RDS-2192-741	6005RDS-2192-742
			6004RDS-2192-751	6004RDS-2192-752	6005RDS-2192-751	6005RDS-2192-752
			6004RDS-2192-781	6004RDS-2192-782	6005RDS-2192-781	6005RDS-2192-782
6004RDS-2192-131	6004RDS-2192-132	6005RDS-2192-131	6005RDS-2192-132			
Smith & Wesson M&P C.O.R.E w/ ITI M3 Light TLR-1, TLR-1HL, SureFire X200/X300/X300U 5" BBL	Cordura® Cordura® Cordura® Cordura® Tactical	MultiCam® Ranger Green Coyote Khaki Black Black	6004RDS-8192-701	6004RDS-8192-702	6005RDS-8192-701	6005RDS-8192-702
			6004RDS-8192-731	6004RDS-8192-732	6005RDS-8192-731	6005RDS-8192-732
			6004RDS-8192-741	6004RDS-8192-742	6005RDS-8192-741	6005RDS-8192-742
			6004RDS-8192-751	6004RDS-8192-752	6005RDS-8192-751	6005RDS-8192-752
			6004RDS-8192-781	6004RDS-8192-782	6005RDS-8192-781	6005RDS-8192-782
6004RDS-8192-131	6004RDS-8192-132	6005RDS-8192-131	6005RDS-8192-132			

Tactical Holsters

6004/6005 SLS TACTICAL HOLSTER FOR: REVOLVERS



6004



6005 W/QUICK RELEASE

FEATURES

- ▶ SLS allows for a smoother, single-motion draw and greater protection against attempted weapon takeaways
- ▶ Features the SLS (Self Locking System) rotating hood system
- ▶ Hood Guard is standard; optional Sentry available
- ▶ Thermal-molded SafariLaminate™ construction protects handgun and sights
- ▶ Standard double strap leg shroud with mounting holes for optional accessories
- ▶ Offered for weapons with and without rail mounted lights
- ▶ Suede lined to protect handgun's finish
- ▶ Leg strap features silicone strips for nonslip traction
- ▶ Available in STX Tactical® Black, Foliage Green, OD Green, Coyote Brown and FDE Brown finishes

A complete list of tactical accessories begins on page 161.

*Available In These Additional Finishes:

Sample Code	6004-83-541
Foliage Green	6004-XX-54X
OD Green	6004-XX-56X
FDE Brown	6004-XX-55X
Coyote Brown	6004-XX-76X

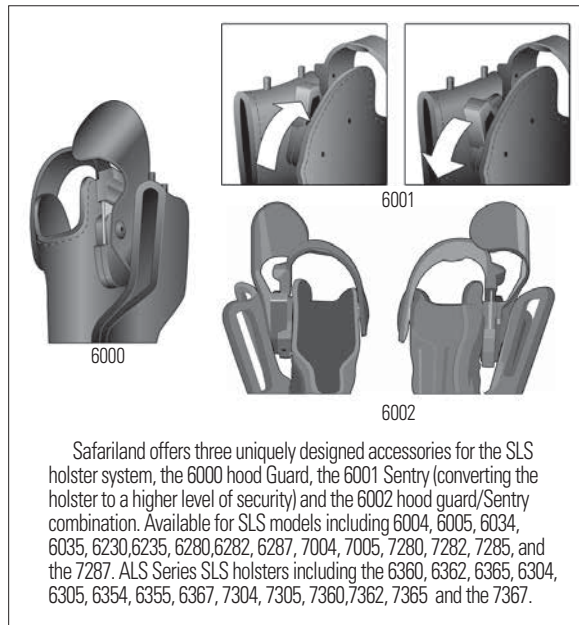

Models 6004/6005 may be used in conjunction with the Drop Flex Adapter and can also be used with the QLS Systems.

The Drop Flex Adapter allows a user to wear a rig below the hip without shifting weight further down the leg and it will also keep the rig from sliding on belt. It can only be used with the single leg strap. (see page 147)

Description

Sample Part No.

DFA on Single Leg Strap 6004-XX-121-MS25
w/ Model 6004

DFA on Single Leg Strap 6004-XX-121-MS19-MS27
w/ QLS w/ Model 6004

Model 6005 uses the same part numbers as model 6004

How to Order
Duty Holsters
Duty Accessories
Tactical Holsters
Tactical Accessories
Duty Belts
QAS
Speed Loaders
Light Systems
Concealment Holsters
Concealment Accessories
Competition
Apparel
Sales Support
Index/Price List

Tactical Holsters

6004/6005 SLS TACTICAL HOLSTERS FOR: REVOLVERS (continued)

GUN DESCRIPTION	FINISH*	COLOR	6004		6005 W/QUICK RELEASE	
			RIGHT	LEFT	RIGHT	LEFT
Ruger Security Six, Service Six, Speed Six 4" BBL	STX Tactical	Black	6004-09-121	6004-09-122	6005-09-121	6005-09-122
	STX Tactical	Foliage Green	6004-09-541	6004-09-542	6005-09-541	6005-09-542
	STX Tactical	Coyote Brown	6004-09-761	6004-09-762	6005-09-761	6005-09-762
	STX Tactical	OD Green	6004-09-561	6004-09-562	6005-09-561	6005-09-562
Smith & Wesson 10, 12, 13, 15, 19, 64, 65, 66, 67, 617, 648 K Medium Frame 4" BBL	STX Tactical	Black	6004-09-121	6004-09-122	6005-09-121	6005-09-122
	STX Tactical	Foliage Green	6004-09-541	6004-09-542	6005-09-541	6005-09-542
	STX Tactical	Coyote Brown	6004-09-761	6004-09-762	6005-09-761	6005-09-762
	STX Tactical	OD Green	6004-09-561	6004-09-562	6005-09-561	6005-09-562
Smith & Wesson 581, 586, 681, 686 L Medium Frame 4" BBL	STX Tactical	Black	6004-21-121	6004-21-122	6005-21-121	6005-21-122
	STX Tactical	Foliage Green	6004-21-541	6004-21-542	6005-21-541	6005-21-542
	STX Tactical	Coyote Brown	6004-21-761	6004-21-762	6005-21-761	6005-21-762
	STX Tactical	OD Green	6004-21-561	6004-21-562	6005-21-561	6005-21-562

SLS Hood Guard	Black	6000-1	6000-2
	Foliage Green	6000-541	6000-542
	Coyote Brown	6000-761	6000-762
	OD Green	6000-561	6000-562
SLS Sentry	Black	6001-1	6001-2
SLS Hood Guard/Sentry	Black	6002-1	6002-2
	Foliage Green	6002-541	6002-542
	Coyote Brown	6002-761	6002-762
	OD Green	6002-1-561	6002-1-562
	FDE Brown	6002-1-551	6002-1-552

Tactical Holsters

6034/6035 SLS MILITARY TACTICAL HOLSTERS FOR: PISTOLS



6034



6035 W/QUICK RELEASE

FEATURES

- ▶ Designed to accommodate the Beretta M9/92F or Sig P226 pistol with or without a light or LAM unit
- ▶ Ambidextrous body design
- ▶ Hood Guard is standard; optional Sentry available
- ▶ Features the SLS (Self Locking System) rotating hood system
- ▶ SLS allows for a smoother, single-motion draw and greater protection against attempted weapon takeaways
- ▶ Thermal-molded SafariLaminate™ construction protects handgun and sights
- ▶ Standard double strap leg shroud with mounting holes for optional accessories

- ▶ Adjustable vertical leg strap with quick-release buckle
- ▶ Available in STX Tactical® Black, Foliage Green, OD Green, Coyote Brown and FDE Brown finishes

A complete list of tactical accessories begins on page 161.

Models 6034/6035 may be used in conjunction with the Drop Flex Adapter and can also be used with the QLS Systems.

The Drop Flex Adapter allows a user to wear a rig below the hip without shifting weight further down the leg and it will also keep the rig from sliding on belt. It can only be used with the single leg strap. (see page 147)

Description	Sample Part No.
DFA on Single Leg Strap w/ Model 6034	6034-XX-131-MS25
DFA on Single Leg Strap w/ QLS w/ Model 6034	6034-XX-131-MS19-MS27
Model 6035 will use the Model 6034 Part No.	

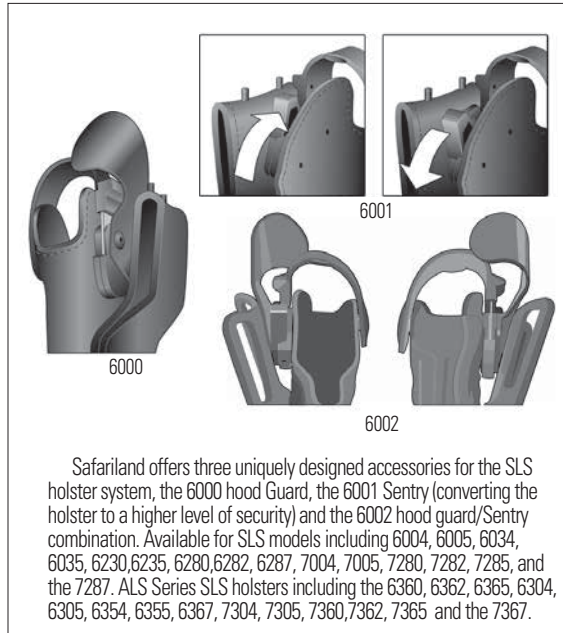

Safariland offers three uniquely designed accessories for the SLS holster system, the 6000 hood Guard, the 6001 Sentry (converting the holster to a higher level of security) and the 6002 hood guard/Sentry combination. Available for SLS models including the 6004, 6005, 6034, 6035, 6230, 6235, 6280, 6282, 6287, 7004, 7005, 7280, 7282, 7285, and the 7287. ALS Series SLS holsters including the 6360, 6362, 6365, 6304, 6305, 6354, 6355, 6367, 7304, 7305, 7360, 7362, 7365 and the 7367.

GUN DESCRIPTION	FINISH	COLOR	6034		6035 W/QUICK RELEASE	
			RIGHT	LEFT	RIGHT	LEFT
Beretta 92F w/ ITI Mount w/ ITI M3X/M6X M3/M6 SureFire X200/X300 4.9" BBL	STX Tactical	Black	6034-7312-131	6034-7312-132	6035-7312-131	6035-7312-132
	STX Foliage Green	Foliage Green	6034-7312-541	6034-7312-542	6035-7312-541	6035-7312-542
	STX Coyote Brown	Coyote Brown	6034-7312-761	6034-7312-762	6035-7312-761	6035-7312-762
	STX OD Green	OD Green	6034-7312-561	6034-7312-562	6035-7312-561	6035-7312-562
	STX FDE Brown	FDE Brown	6034-7312-551	6034-7312-552	6035-7312-551	6035-7312-552
Sig Sauer P220, P226 w/ ITI Mount w/ ITI M3X/M6X, M3/M6 SureFire X200/X300 4.41" BBL	STX Tactical	Black	6034-7712-131	6034-7712-132	6035-7712-131	6035-7712-132
	STX Foliage Green	Foliage Green	6034-7712-541	6034-7712-542	6035-7712-541	6035-7712-542
	STX Coyote Brown	Coyote Brown	6034-7712-761	6034-7712-762	6035-7712-761	6035-7712-762
	STX OD Green	OD Green	6034-7712-561	6034-7712-562	6035-7712-561	6035-7712-562
	STX FDE Brown	FDE Brown	6034-7712-551	6034-7712-552	6035-7712-551	6035-7712-552

Tactical Holsters

6230/6235 SLS MID-RIDE MILITARY HOLSTERS FOR: PISTOLS



6230 MID-RIDE



6235 LOW-RIDE

FEATURES

- ▶ Designed to accommodate the Beretta M9/ 92F or Sig P226 pistol with or without a light or LAM unit
- ▶ Ambidextrous body design
- ▶ Hood Guard is standard; optional Sentry available
- ▶ Features the SLS (Self Locking System) rotating hood system
- ▶ SLS allows for a smoother, single motion draw and greater protection against attempted weapon takeaways
- ▶ Thermal-molded SafariLaminate™ construction protects handgun and sights
- ▶ Available in STX Tactical® Black, Foliage Green, OD Green, Coyote Brown and FDE Brown finishes

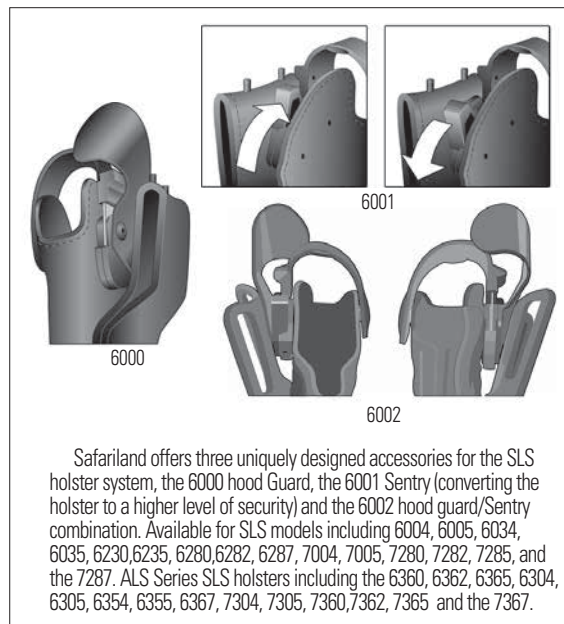

GUN DESCRIPTION	FINISH	COLOR	6230 MID-RIDE		6235 LOW-RIDE	
			RIGHT	LEFT	RIGHT	LEFT
Beretta 92F w/ ITI Mount w/ ITI M3X/M6X M3/M6, SureFire X200/X300 4.9" BBL	STX Tactical	Black	6230-7312-131	6230-7312-132	6235-7312-131	6230-7312-132
	STX Foliage Green	Foliage Green	6230-7312-541	6230-7312-542	6235-7312-541	6230-7312-542
	STX Coyote Brown	Coyote Brown	6230-7312-761	6230-7312-762	6235-7312-761	6230-7312-762
	STX OD Green	OD Green	6230-7312-561	6230-7312-562	6235-7312-561	6230-7312-562
	STX FDE Brown	FDE Brown	6030-7312-551	6030-7312-552	6035-7312-551	6030-7312-552
Sig Sauer P220, P226 w/ ITI Mount w/ ITI M3X/M6X, M3/M6 SureFire X200/X300 4.41" BBL	STX Tactical	Black	6230-7712-131	6230-7712-132	6235-7712-131	6230-7712-132
	STX Foliage Green	Foliage Green	6230-7712-541	6230-7712-542	6235-7712-541	6230-7712-542
	STX Coyote Brown	Coyote Brown	6230-7712-761	6230-7712-762	6235-7712-761	6230-7712-762
	STX OD Green	OD Green	6230-7712-561	6230-7712-562	6235-7712-561	6230-7712-562
	STX FDE Brown	FDE Brown	6230-7712-551	6230-7712-552	6235-7712-551	6230-7712-552

Tactical Holsters

6304/6305 ALS®/SLS TACTICAL HOLSTERS FOR: PISTOLS



PATENTED

6304



PATENTED

6305 W/QUICK RELEASE

FEATURES

- ▶ ALS® (Automatic Locking System) secures weapon once holstered
- ▶ SLS allows for a smoother, single motion draw and greater protection against attempted weapon takeaways
- ▶ Hood Guard is standard
- ▶ Simple straight up draw once all releases are deactivated
- ▶ Thermal-molded SafariLaminate™ construction protects handgun and sights
- ▶ Standard double strap leg shroud with mounting holes for optional accessories
- ▶ Adjustable vertical leg strap
- ▶ Offered for weapons with and without rail mounted lights
- ▶ Suede lined to protect handgun's finish
- ▶ Leg straps features silicone strips for non-slip traction
- ▶ Available in STX Tactical® Black, Foliage Green, OD Green, Coyote Brown and FDE Brown finishes

A complete list of tactical accessories begins on page 161.

*Available In These Additional Finishes:
 Sample Code 6304-83-54I
 Foliage Green 6304-XX-54X
 Coyote Brown 6304-XX-76X
 OD Green 6304-XX-56X
 FDE Brown 6304-XX-55X

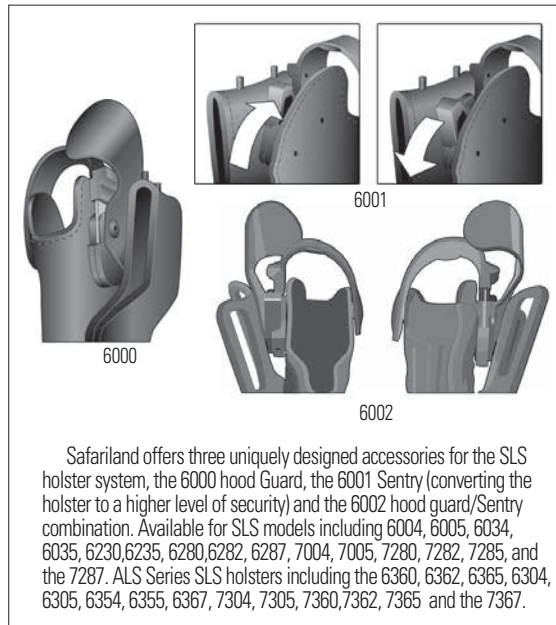

Safariland offers three uniquely designed accessories for the SLS holster system, the 6000 hood Guard, the 6001 Sentry (converting the holster to a higher level of security) and the 6002 hood guard/Sentry combination. Available for SLS models including 6004, 6005, 6034, 6035, 6230, 6235, 6280, 6282, 6287, 7004, 7005, 7280, 7282, 7285, and the 7287. ALS Series SLS holsters including the 6360, 6362, 6365, 6304, 6305, 6354, 6355, 6367, 7304, 7305, 7360, 7362, 7365 and the 7367.

Models 6304/6305 may be used in conjunction with the Drop Flex Adapter and can also be used with the QLS Systems.

The Drop Flex Adapter allows a user to wear a rig below the hip without shifting weight further down the leg and it will also keep the rig from sliding on belt. It can only be used with the single leg strap. (see page 147)

Description	Sample Part No.
DFA on Single Leg Strap w/ Model 6304	6304-XX-131-MS25
DFA on Single Leg Strap w/ QLS w/ Model 6304	6304-XX-131-MS19-MS27

Model 6305 uses the same part numbers as model 6304.

Models 6304/6305 Tactical Holsters include installed Hood Guard
 Sample Code with Sentry installed:
 6304-83-131-S
 Sample Code with Hood Guard Sentry:
 6304-83-131-SH

How to Order
Duty Holsters
Duty Accessories
Tactical Holsters
Tactical Accessories
Duty Belts
QAS
Speed Loaders
Light Systems
Concealment Holsters
Concealment Accessories
Competition
Apparel
Sales Support
Index/Price List

Tactical Holsters

6304/6305 ALS®/SLS TACTICAL HOLSTERS FOR: PISTOLS (continued)

	GUN DESCRIPTION	FINISH*	COLOR	6304		6305 W/QUICK RELEASE	
				RIGHT	LEFT	RIGHT	LEFT
How to Order	Beretta APX 9mm, .40 S&W 4.25" BBL	STX Tactical	Black	6304-677-131	6304-677-132	6305-677-131	6305-677-132
Duty Holsters	Beretta Px4 Storm 9mm, .40 4" BBL	STX Tactical	Black	6304-180-131	6304-180-132	6305-180-131	6305-180-132
Duty Accessories	Beretta Px4 Storm .45ACP 4.1" BBL	STX Tactical	Black	6304-185-131	6304-185-132	6305-185-131	6305-185-132
Tactical Holsters	Beretta 92F, 92FS, 92G, 96, 96G 4.9" BBL	STX Tactical	Black	6304-73-131	6304-73-132	6305-73-131	6305-73-132
Tactical Accessories	Colt Government 1911 5" BBL	STX Tactical	Black	6304-53-131	6304-53-132	6305-53-131	6305-53-132
Duty Belts	CZ P-07 3.8" BBL	STX Tactical	Black	6304-292-131	6304-292-132	6305-292-131	6305-292-132
OAS	FN FNS, 9mm, .40 4" BBL	STX Tactical	Black	6304-266-131	6304-266-132	6305-266-131	6305-266-132
Speed Loaders	Glock 17, 22 4.5" BBL	STX Tactical	Black	6304-83-131	6304-83-132	6305-83-131	6305-83-132
Light Systems	Glock 17, 22 w/ Dual Magazine Release 4.5" BBL	STX Tactical	Black	6304-983-131	6304-983-132	6305-983-131	6305-983-132
Concealment Holsters	Glock 17, 22 w/ ITI M3 Light TLR-1, TLR-1HL, SureFire X200/X300/X300U 4.5" BBL	STX Tactical	Black	6304-832-131	6304-832-132	6305-832-131	6305-832-132
Concealment Accessories	Glock 17, 22 w/ ITI M3X or TLR-1 4.5" BBL	STX Tactical	Black	6304-8311-131	6304-8311-132	6305-8311-131	6305-8311-132
Competition	Glock 17, 22 w/ GTL 10 Light Only GTL 21/22 Light/Laser Combination GTL 51/52 Light/Laser Combination 4.5" BBL	STX Tactical	Black	6304-8310-131	6304-8310-132	6305-8310-131	6305-8310-132
Apparel	Glock 19, 23 4" BBL 26, 27 3.5" BBL	STX Tactical	Black	6304-283-131	6304-283-132	6305-283-131	6305-283-132
Sales Support	Glock 19, 23 w/ ITI M3, TLR-1, TLR-1HL, Insight XTI Procyon, SureFire X200/X300/X300U 4" BBL	STX Tactical	Black	6304-2832-131	6304-2832-132	6305-2832-131	6305-2832-132
Index/Price List	Glock 20, 21 4.6" BBL	STX Tactical	Black	6304-383-131	6304-383-132	6305-383-131	6305-383-132
	Glock 20, 21 w/ ITI M3, TLR-1, TLR-1HL, SureFire X200/X300/X300U 4.6" BBL	STX Tactical	Black	6304-3832-131	6304-3832-132	6305-3832-131	6305-3832-132
	Glock 30S 3.77" BBL	STX Tactical	Black	6304-485-131	6304-485-132	6305-485-131	6305-485-132
	Glock 34, 35 5.32" BBL	STX Tactical	Black	6304-683-131	6304-683-132	6305-683-131	6305-683-132
	Glock 34, 35 w/ ITI M3, TLR-1, TLR-1HL, SureFire X200/X300/X300U 5.32" BBL	STX Tactical	Black	6304-6832-131	6304-6832-132	6305-6832-131	6305-6832-132

Tactical Holsters

6304/6305 ALS®/SLS TACTICAL HOLSTERS FOR: PISTOLS (continued)

GUN DESCRIPTION	FINISH*	COLOR	6304		6305 W/QUICK RELEASE	
			RIGHT	LEFT	RIGHT	LEFT
Glock 37 4.5" BBL	STX Tactical	Black	6304-783-131	6304-783-132	6305-783-131	6305-783-132
Glock 37 w/ ITI M3, TLR-1, TLR-1HL, SureFire X200/X300/X300U 4.5" BBL	STX Tactical	Black	6304-7832-131	6304-7832-132	6305-7832-131	6305-7832-132
Glock 29, 30 3.78" BBL	STX Tactical	Black	6304-483-131	6304-483-132	6305-483-131	6305-483-132
Glock 41 5.31" BBL	STX Tactical	Black	6304-893-131	6304-893-132	6305-893-131	6305-893-132
Glock 41 w/ ITI M3, TLR-1, TLR-1HL, SureFire X200/X300/X300U 5.31" BBL	STX Tactical	Black	6304-8932-131	6304-8932-132	6305-8932-131	6305-8932-132
Heckler & Koch P30 DAO 3.875" BBL	STX Tactical	Black	6304-295-131	6304-295-132	6305-295-131	6305-295-132
Heckler & Koch P30 w/ ITI M3, TLR-1, TLR-1HL, SureFire X200/X300/X300U 3.78" BBL	STX Tactical	Black	6304-2952-131	6304-2952-132	6305-2952-131	6305-2952-132
Heckler & Koch P30L w/ ITI M3, TLR-1, SureFire X200/X300/X300U 4.45" BBL	STX Tactical	Black	6304-3952-131	6304-3952-132	6305-3952-131	6305-3952-132
Heckler & Koch USP 9/40 w/ TRL-3 4.25" BBL	STX Tactical	Black	6304-29116-131	6304-29116-132	6305-29116-131	6305-29116-132
Heckler & Koch USP 9C 4.25" BBL	STX Tactical	Black	6304-291-131	6304-291-132	6305-291-131	6305-291-132
Heckler & Koch USP 9mm, .40 4.13" BBL	STX Tactical	Black	6304-91-131	6304-91-132	6305-91-131	6305-91-132
Heckler & Koch P2000 3.5" BBL	STX Tactical	Black	6304-97-131	6304-97-132	6305-97-131	6305-97-132
Heckler & Koch P2000 US Version w/ ITI M3, TLR-1, TLR-1HL, SureFire X200/X300/X300U 3.5" BBL	STX Tactical	Black	6304-1972-131	6304-1972-132	6305-1972-131	6305-1972-132
Heckler & Koch VP9 4.09" BBL	STX Tactical	Black	6304-593-131	6304-593-132	6305-593-131	6305-593-132
Heckler & Koch VP9 w/ ITI M3, TLR-1, TLR-1HL, SureFire X200/X300/X300U 4.09" BBL	STX Tactical	Black	6304-5932-131	6304-5932-132	6305-5932-131	6305-5932-132
Sig Sauer P220, P226 4.41" BBL	STX Tactical	Black	6304-77-131	6304-77-132	6305-77-131	6305-77-132
Sig Sauer P220R DAK, P226R DAK .40 w/ Bobbed Hammer; P220R DA/SA, P226R DA/SA .40 w/ Full Size Hammer 4.41" BBL	STX Tactical	Black	6304-477-131	6304-477-132	6305-477-131	6305-477-132
Sig Sauer P220R, P226R w/ ITI M3 Light TLR-1, TLR-1HL, SureFire X200/X300/X300U, w/ Accessory Rails 4.41" BBL	STX Tactical	Black	6304-7742-131	6304-7742-132	6305-7742-131	6305-7742-132
Sig Sauer P225 3.86" BBL	STX Tactical	Black	6304-79-131	6304-79-132	6305-79-131	6305-79-132

How to Order
Duty Holsters
Duty Accessories
Tactical Holsters
Tactical Accessories
Duty Belts
QAS
Speed Loaders
Light Systems
Concealment Holsters
Concealment Accessories
Competition
Apparel
Sales Support
Index/Price List

Tactical Holsters

6304/6305 ALS®/SLS TACTICAL HOLSTERS FOR: PISTOLS (continued)

	GUN DESCRIPTION	FINISH*	COLOR	6304		6305 W/QUICK RELEASE	
				RIGHT	LEFT	RIGHT	LEFT
How to Order	Sig Sauer P228, P229 3.9" BBL	STX Tactical	Black	6304-74-131	6304-74-132	6305-74-131	6305-74-132
Duty Holsters	Sig Sauer P229R DAK .40 P229R DA/SA .40 w/ Full Size Hammer 3.9" BBL	STX Tactical	Black	6304-447-131	6304-447-132	6305-447-131	6305-447-132
Duty Accessories	Sig Sauer P229R, w/ ITI M3, TLR-1, TLR-1HL, SureFire X200/X300/X300U 3.9" BBL	STX Tactical	Black	6304-7442-131	6304-7442-132	6305-7442-131	6305-7442-132
Tactical Holsters	Sig Sauer P239 3.625" BBL	STX Tactical	Black	6304-754-131	6304-754-132	6305-754-131	6305-754-132
Tactical Accessories	Sig Sauer P250 Compact 9mm, .40, .45 3.9" BBL	STX Tactical	Black	6304-750-131	6304-750-132	6305-750-131	6305-750-132
Duty Belts	Sig Sauer P250 9mm, .40, .45 4.7" BBL	STX Tactical	Black	6304-450-131	6304-450-132	6305-450-131	6305-450-132
OAS	Sig Sauer P320 9/40 w/ ITI M3, TLR-1, TLR-1HL SureFire X200/X300/X300U 4.7" BBL	STX Tactical	Black	6304-4502-131	6304-4502-132	6305-4502-131	6305-4502-132
Speed Loaders	Sig Sauer SP2022 3.5" BBL	STX Tactical	Black	6304-278-131	6304-278-132	6305-278-131	6305-278-132
Light Systems	Sig Sauer P320 4.7" BBL	STX Tactical	Black	6304-450-131	6304-450-132	6305-450-131	6305-450-132
Light Systems	Sig Sauer P320C 3.9" BBL	STX Tactical	Black	6304-750-131	6304-750-132	6305-750-131	6305-750-132
Concealment Holsters	Smith & Wesson M&P 9mm, .40, .22LR 4.25" BBL M&P 9C 3.375" BBL	STX Tactical	Black	6304-219-131	6304-219-132	6305-219-131	6305-219-132
Concealment Holsters	Smith & Wesson M&P 9mm, .40, w/ ITI M3, TLR-1HL, TLR-1, SureFire X200/X300/X300U 4.25" BBL	STX Tactical	Black	6304-2192-131	6304-2192-132	6305-2192-131	6305-2192-132
Concealment Accessories	Smith & Wesson M&P 9L 5" BBL	STX Tactical	Black	6304-819-131	6304-819-132	6305-819-131	6305-819-132
Concealment Accessories	Smith & Wesson M&P 9L w/ Thumb Safety 5" BBL	STX Tactical	Black	6304-820-131	6304-820-132	6305-820-131	6305-820-132
Competition	Smith & Wesson 4566TSW, w/ Picatinny Rails and ITI M3, TLR-1, SureFire X200/X300/X300U 4.25" BBL	STX Tactical	Black	6304-4302-131	6304-4302-132	6305-4302-131	6305-4302-132
Apparel	Smith & Wesson M&P .45, w/o Thumb Safety 4.5" BBL	STX Tactical	Black	6304-419-131	6304-419-132	6305-419-131	6305-419-132
Apparel	Smith & Wesson M&P 45C, w/o Thumb Safety 4" BBL	STX Tactical	Black	6304-919-131	6304-919-132	6305-919-131	6305-919-132
Sales Support	Smith & Wesson M&P 45C, w/ Thumb Safety 4" BBL	STX Tactical	Black	6304-920-131	6304-920-132	6305-920-131	6305-920-132
Index/Price List	Smith & Wesson M&P 45C, w/o Thumb Safety, w/ ITI M3, TLR-1, TLR-1HL, SureFire X200/X300/X300U 4" BBL	STX Tactical	Black	6304-9192-131	6304-9192-132	6305-9192-131	6305-9192-132

Tactical Holsters

6304/6305 ALS®/SLS TACTICAL HOLSTERS FOR: PISTOLS (continued)

GUN DESCRIPTION	FINISH*	COLOR	6304		6305 W/QUICK RELEASE	
			RIGHT	LEFT	RIGHT	LEFT
Smith & Wesson M&P 45C, w/ Thumb Safety, w/ ITI M3, TLR-1, TLR-1HL SureFire X200/X300/X300U 4" BBL	STX Tactical	Black	6304-9202-131	6304-9202-132	6305-9202-131	6305-9202-132
Smith & Wesson M&P .45 w/o Thumb Safety, w/ ITI M3, TLR-1, TLR-1HL, SureFire X200/X300/X300U 4.5" BBL	STX Tactical	Black	6304-4192-131	6304-4192-132	6305-4192-131	6305-4192-132
Smith & Wesson M&P .45, w/ Thumb Safety 4.5" BBL	STX Tactical	Black	6304-519-131	6304-519-132	6305-519-131	6305-519-132
Smith & Wesson M&P .45, w/ Thumb Safety, w/ ITI M3, TLR-1, TLR-1HL, SureFire X200/X300/X300U 4.5" BBL	STX Tactical	Black	6304-5192-131	6304-5192-132	6305-5192-131	6305-5192-132
Smith & Wesson SW99 4" BBL	STX Tactical	Black	6304-84-131	6304-84-132	6305-84-131	6305-84-132
Smith & Wesson 5946 & 5943 DAO, w/o Rails 4" BBL	STX Tactical	Black	6304-320-131	6304-320-132	6305-320-131	6305-320-132
Sphinx SPD-S 4.5" BBL	STX Tactical	Black	6304-281-131	6304-281-132	6305-281-131	6305-281-132
Sphinx SPD-S w/ WLI-AA ITI M3, TLR-1 4.5" BBL	STX Tactical	Black	6304-28115-131	6304-28115-132	6305-28115-131	6305-28115-132
Springfield Armory XD 9mm, .40, .357, .45 4" BBL	STX Tactical	Black	6304-148-131	6304-148-132	6305-148-131	6305-148-132
Springfield Armory XD 9mm, .40, .357, .45 5" BBL	STX Tactical	Black	6304-149-131	6304-149-132	6305-149-131	6305-149-132
Springfield Armory XD(M) 9mm 4.5" BBL	STX Tactical	Black	6304-145-131	6304-145-132	6305-145-131	6305-145-132
Springfield Armory XD(M) 9mm w/ ITI M3, TLR-1, TLR-1HL, SureFire X200/X300/X300U 4.5" BBL	STX Tactical	Black	6304-1452-131	6304-1452-132	6305-1452-131	6305-1452-132
Springfield Armory XD 9mm w/ ITI M3, TLR-1, TLR-1HL, SureFire X200/X300/X300U 4" BBL	STX Tactical	Black	6304-462-131	6304-462-132	6305-462-131	6305-462-132
Springfield Armory XD .40, .45 w/ ITI M3, TLR-1, TLR-1HL, SureFire X200/X300/X300U 4" BBL	STX Tactical	Black	6304-1482-131	6304-1482-132	6305-1482-131	6305-1482-132
Springfield Armory XD(M) .40, .45 4.5" BBL	STX Tactical	Black	6304-146-131	6304-146-132	6305-146-131	6305-146-132
Springfield Armory XD 45 9mm, .40, .45 w/ ITI M3, TLR-1, TLR-1HL, SureFire X200/X300/X300U 5" BBL	STX Tactical	Black	6304-1492-131	6304-1492-132	6305-1492-131	6305-1492-132
Springfield Armory Operator 1911A-1, TLR-1HL, w/ Surefire X200/X300/X300U 5" BBL	STX Tactical	Black	6304-560-131	6304-560-132	6305-560-131	6305-560-132
Springfield Armory Operator 1911-A1 w/ Picatinny Light Rail 4" BBL	STX Tactical	Black	6304-56-131	6304-56-132	6305-56-131	6305-56-132

How to Order
Duty Holsters
Duty Accessories
Tactical Holsters
Tactical Accessories
Duty Belts
QAS
Speed Loaders
Light Systems
Concealment Holsters
Concealment Accessories
Competition
Apparel
Sales Support
Index/Price List

Tactical Holsters

6304/6305 ALS®/SLS TACTICAL HOLSTERS FOR: PISTOLS (continued)

GUN DESCRIPTION	FINISH*	COLOR	6304		6305 W/QUICK RELEASE	
			RIGHT	LEFT	RIGHT	LEFT
Taurus PT840, PT809 4" BBL	STX Tactical	Black	6304-268-131	6304-268-132	6305-268-131	6305-268-132
Walther P99C QA 3.4" BBL	STX Tactical	Black	6304-84-131	6304-84-132	6305-84-131	6305-84-132
Walther PPO 4" BBL	STX Tactical	Black	6304-384-131	6304-384-132	6305-384-131	6305-384-132
Walther P99C 4.5" BBL	STX Tactical	Black	6304-284-131	6304-284-132	6305-284-131	6305-284-132

SLS Hood Guard	Black	6000-1	6000-2
	Foliage Green	6000-541	6000-542
	Coyote Brown	6000-761	6000-762
	OD Green	6000-561	6000-562
	FDE Brown	6000-551	6000-552
SLS Sentry	Black	6001-1	6001-2
SLS Hood Guard/Sentry	Black	6002-1	6002-2
	Foliage Green	6002-541	6002-542
	Coyote Brown	6002-761	6002-762
	OD Green	6002-561	6002-562
	FDE Brown	6002-551	6002-552

Tactical Holsters

6304/6305 RDS ALS®/SLS TACTICAL HOLSTERS FOR: PISTOLS

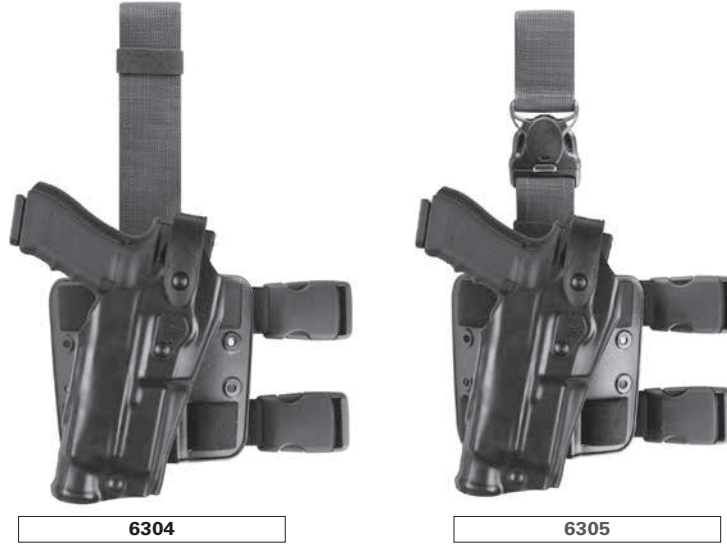

FEATURES

- ▶ ALS® (Automatic Locking System) secures weapon once holstered
- ▶ SLS (Self Locking System) Rotating Hood
- ▶ Hood Guard is standard
- ▶ For use with red dot optic-equipped weapons
- ▶ Adjustable vertical leg strap
- ▶ Leg strap features silicone strips for nonslip traction
- ▶ SafariLaminate™ thermal-molded construction protects handgun and sights
- ▶ Suede lined to protect handgun's finish
- ▶ Available in Cordura® Nylon, MultiCam®, Ranger Green, Coyote, Khaki, or Black finishes

A complete list of tactical accessories begins on page 161

GUN DESCRIPTION	FINISH*	COLOR	6354RDS		6355RDS W/QUICK RELEASE	
			RIGHT	LEFT	RIGHT	LEFT
Glock 17/22 w/ ITI M3 Light, TLR-1, SureFire X200/X300/X300U 4.5" BBL	Cordura®	MultiCam®	6304RDS-832-701	6304RDS-832-702	6305RDS-832-701	6305RDS-832-702
	Cordura®	Ranger Green	6304RDS-832-731	6304RDS-832-732	6305RDS-832-731	6305RDS-832-732
	Cordura®	Coyote	6304RDS-832-741	6304RDS-832-742	6305RDS-832-741	6305RDS-832-742
	Cordura®	Khaki	6304RDS-832-751	6304RDS-832-752	6305RDS-832-751	6305RDS-832-752
	Cordura®	Black	6304RDS-832-781	6304RDS-832-782	6305RDS-832-781	6305RDS-832-782
	Tactical	Black	6304RDS-832-131	6304RDS-832-132	6305RDS-832-131	6305RDS-832-132
Glock 19/23 w/ITI M3 Light, TLR-1, SureFire X200/X300/X300U 4" BBL	Cordura®	MultiCam®	6304RDS-2832-701	6304RDS-2832-702	6305RDS-2832-701	6305RDS-2832-702
	Cordura®	Ranger Green	6304RDS-2832-731	6304RDS-2832-732	6305RDS-2832-731	6305RDS-2832-732
	Cordura®	Coyote	6304RDS-2832-741	6304RDS-2832-742	6305RDS-2832-741	6305RDS-2832-742
	Cordura®	Khaki	6304RDS-2832-751	6304RDS-2832-752	6305RDS-2832-751	6305RDS-2832-752
	Cordura®	Black	6304RDS-2832-781	6304RDS-2832-782	6305RDS-2832-781	6305RDS-2832-782
	Tactical	Black	6304RDS-2832-131	6304RDS-2832-132	6305RDS-2832-131	6305RDS-2832-132
Glock 34/35 w/ITI M3 Light, TLR-1, SureFire X200/X300/X300U 5.32" BBL	Cordura®	MultiCam®	6304RDS-6832-701	6304RDS-6832-702	6305RDS-6832-701	6305RDS-6832-702
	Cordura®	Ranger Green	6304RDS-6832-731	6304RDS-6832-732	6305RDS-6832-731	6305RDS-6832-732
	Cordura®	Coyote	6304RDS-6832-741	6304RDS-6832-742	6305RDS-6832-741	6305RDS-6832-742
	Cordura®	Khaki	6304RDS-6832-751	6304RDS-6832-752	6305RDS-6832-751	6305RDS-6832-752
	Cordura®	Black	6304RDS-6832-781	6304RDS-6832-782	6305RDS-6832-781	6305RDS-6832-782
	Tactical	Black	6304RDS-6832-131	6304RDS-6832-132	6305RDS-6832-131	6305RDS-6832-132
Smith & Wesson M&P 9mm, .40 w/ITI, M3 Light, TLR-1, TLR-1HL, Surefire X200/X300/X300U X300U 4.25" BBL	Cordura®	MultiCam®	6304RDS-2192-701	6304RDS-2192-702	6305RDS-2192-701	6305RDS-2192-702
	Cordura®	Ranger Green	6304RDS-2192-731	6304RDS-2192-732	6305RDS-2192-731	6305RDS-2192-732
	Cordura®	Coyote	6304RDS-2192-741	6304RDS-2192-742	6305RDS-2192-741	6305RDS-2192-742
	Cordura®	Khaki	6304RDS-2192-751	6304RDS-2192-752	6305RDS-2192-751	6305RDS-2192-752
	Cordura®	Black	6304RDS-2192-781	6304RDS-2192-782	6305RDS-2192-781	6305RDS-2192-782
	Tactical	Black	6304RDS-2192-131	6304RDS-2192-132	6305RDS-2192-131	6305RDS-2192-132
Smith & Wesson M&P C.O.R.E w/ITI M3 Light, TLR-1 SureFire X200/X300/X300U 5" BBL	Cordura®	MultiCam®	6304RDS-8192-701	6304RDS-8192-702	6305RDS-8192-701	6305RDS-8192-702
	Cordura®	Ranger Green	6304RDS-8192-731	6304RDS-8192-732	6305RDS-8192-731	6305RDS-8192-732
	Cordura®	Coyote	6304RDS-8192-741	6304RDS-8192-742	6305RDS-8192-741	6305RDS-8192-742
	Cordura®	Khaki	6304RDS-8192-751	6304RDS-8192-752	6305RDS-8192-751	6305RDS-8192-752
	Cordura®	Black	6304RDS-8192-781	6304RDS-8192-782	6305RDS-8192-781	6305RDS-8192-782
	Tactical	Black	6304RDS-8192-131	6304RDS-8192-132	6305RDS-8192-131	6305RDS-8192-132

Tactical Holsters

6354/6355 ALS® TACTICAL HOLSTERS FOR: PISTOLS (continued)

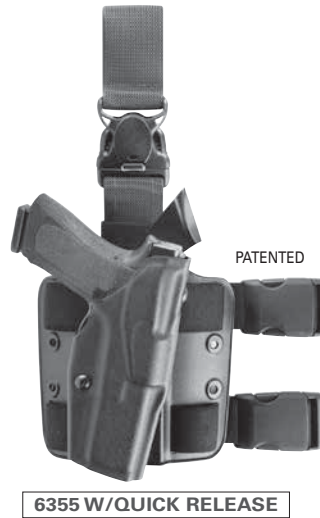

FEATURES

- ▶ ALS® (Automatic Locking System) secures weapon once holstered; simple straight up draw once release is deactivated
- ▶ Suede lined to protect handgun's finish
- ▶ Open-top design without SLS for quick retrieval of weapon
- ▶ Leg straps features silicone strips for non-slip traction
- ▶ Hood Guard is standard; optional ALS Guard available
- ▶ Available in STX Tactical® Black, Foliage Green, OD Green, Coyote Brown and FDE Brown finishes
- ▶ SafariLaminate™ thermal-molded construction protects handgun and sights
- ▶ Standard double strap leg shroud with mounting holes for optional accessories

A complete list of tactical accessories begins on page 161



ALS Guard – Unlocked



ALS Guard – Locked

Models 6354/6355 Tactical Holsters include installed Hood Guard
 Sample Code with ALS Guard Only:
 6354-83-131-AG
 Sample Code with Hood Guard & ALS Guard:
 6354-83-131-AGH

Models 6354/6355 may be used in conjunction with the Drop Flex Adapter and can also be used with either the MLS or QLS Systems. The Drop Flex Adapter allows a user to wear a rig below the hip without shifting weight further down the leg and it will also keep the rig from sliding on belt. It can only be used with the single leg strap. (see page 147)

Description	Sample Part No.
DFA on Single Leg Strap w/ Model 6354	6354-XX-131-MS25
DFA on Single Leg Strap w/ QLS w/ Model 6354	6354-XX-131-MS19-MS27
Model 6355 uses the same part numbers as model 6354	

*Available In These Additional Finishes:
 Sample Code 6304-83-54I
 Foliage Green 6354-XX-54X
 Coyote Brown 6354-XX-76X
 OD Green 6354-XX-56X
 FDE Brown 6354-XX-55X

GUN DESCRIPTION	FINISH*	COLOR	6354		6355 W/QUICK RELEASE	
			RIGHT	LEFT	RIGHT	LEFT
Beretta APX 9mm, .40 S&W 4.25" BBL	STX Tactical	Black	6354-677-131	6354-677-132	6355-677-131	6355-677-132
Beretta Px4 Storm 9mm, .40 4" BBL	STX Tactical	Black	6354-180-131	6354-180-132	6355-180-131	6355-180-132
Beretta Px4 Storm .45ACP 4.1" BBL	STX Tactical	Black	6354-185-131	6354-185-132	6355-185-131	6355-185-132
Beretta 92F, 92FS, 92G, 96, 96G 4.9" BBL	STX Tactical	Black	6354-73-131	6354-73-132	6355-73-131	6355-73-132

Tactical Holsters

6354/6355 ALS® TACTICAL HOLSTERS FOR: PISTOLS

GUN DESCRIPTION	FINISH*	COLOR	6354		6355 W/QUICK RELEASE	
			RIGHT	LEFT	RIGHT	LEFT
Colt Government 1911 5" BBL	STX Tactical	Black	6354-53-131	6354-53-132	6355-53-131	6355-53-132
Colt 1911 w/SureFire X200/X300/X300U 5" BBL	STX Tactical	Black	6354-560-131	6354-560-132	6355-560-131	6355-560-132
CZ P-07 3.8" BBL	STX Tactical	Black	6354-292-131	6354-292-132	6355-292-131	6355-292-132
FN FNS 9mm, .40 4" BBL	STX Tactical	Black	6354-266-131	6354-266-132	6355-266-131	6355-266-132
Glock 17, 22 4.5" BBL	STX Tactical	Black	6354-83-131	6354-83-132	6355-83-131	6355-83-132
Glock 17, 22 w/ Dual Magazine Release 4.5" BBL	STX Tactical	Black	6354-983-131	6354-983-132	6355-983-131	6355-983-132
Glock 17, 22 w/ ITI M3 Light, TLR-1, TLR-1HL, SureFire X200/X300/X300U 4.5" BBL	STX Tactical	Black	6354-832-131	6354-832-132	6355-832-131	6355-832-132
Glock 17, 22 W /GTL 10 Light Only GTL 21/22 Light/Laser Combination GTL 51/52 Light/Laser Combination 4.5" BBL	STX Tactical	Black	6354-8310-131	6354-8310-132	6355-8310-131	6355-8310-132
Glock 19, 23 4" BBL 26, 27 3.5" BBL	STX Tactical	Black	6354-283-131	6354-283-132	6355-283-131	6355-283-132
Glock 19, 23 w/ ITI M3, TLR-1, TLR-1HL, SureFire X200/X300/X300U 4" BBL	STX Tactical	Black	6354-2832-131	6354-2832-132	6355-2832-131	6355-2832-132
Glock 20, 21 4.6" BBL	STX Tactical	Black	6354-383-131	6354-383-132	6355-383-131	6355-383-132
Glock 20, 21 w/ ITI M3, TLR-1, TLR-1HL SureFire X200/X300/X300U 4.6" BBL	STX Tactical	Black	6354-3832-131	6354-3832-132	6355-3832-131	6355-3832-132
Glock 34, 35 5.32" BBL	STX Tactical	Black	6354-683-131	6354-683-132	6355-683-131	6355-683-132
Glock 34, 35 w/ ITI M3, TLR-1, TLR-1HL, SureFire X200/X300/X300U 5.32" BBL	STX Tactical	Black	6354-6832-131	6354-6832-132	6355-6832-131	6355-6832-132
Glock 37 4.5" BBL	STX Tactical	Black	6354-783-131	6354-783-132	6355-783-131	6355-783-132
Glock 37 w/ ITI M3, TLR-1, TLR-1HL, SureFire X200/X300/X300U 4.5" BBL	STX Tactical	Black	6354-7832-131	6354-7832-132	6355-7832-131	6355-7832-132
Glock 41 5.31" BBL	STX Tactical	Black	6354-893-131	6354-893-132	6355-893-131	6355-893-132
Glock 41 w/ ITI M3, TLR-1, TLR-1HL, SureFire X200/X300/X300U 5.31" BBL	STX Tactical	Black	6354-8932-131	6354-8932-132	6355-8932-131	6355-8932-132
Heckler & Koch P30 3.875" BBL	STX Tactical	Black	6354-295-131	6354-295-132	6355-295-131	6355-295-132

How to Order
Duty Holsters
Duty Accessories
Tactical Holsters
Tactical Accessories
Duty Belts
QAS
Speed Loaders
Light Systems
Concealment Holsters
Concealment Accessories
Competition
Apparel
Sales Support
Index/ Price List

Tactical Holsters

6354/6355 ALS® TACTICAL HOLSTERS FOR: PISTOLS (continued)

	GUN DESCRIPTION	FINISH*	COLOR	6354		6355 W/QUICK RELEASE	
				RIGHT	LEFT	RIGHT	LEFT
Duty Holsters	Heckler & Koch P30 w/ ITI M3, TLR-1, TLR-1HL, SureFire X200/X300/X300U 3.78" BBL	STX Tactical	Black	6354-2952-131	6354-2952-132	6355-2952-131	6355-2952-132
Duty Accessories	Heckler & Koch P30L w/ ITI M3, TLR-1, TLR-1HL, SureFire X200/X300/X300U 4.45" BBL	STX Tactical	Black	6354-3952-131	6354-3952-132	6355-3952-131	6355-3952-132
Tactical Holsters	Heckler & Koch USP 9/40 w/ TRL-3 4.25" BBL	STX Tactical	Black	6354-29116-131	6354-29116-132	6355-29116-131	6355-29116-132
Tactical Accessories	Heckler & Koch USP 9C 4.25" BBL	STX Tactical	Black	6354-291-131	6354-291-132	6355-291-131	6355-291-132
Duty Belts	Heckler & Koch USP 9mm, .40 4.13" BBL	STX Tactical	Black	6354-91-131	6354-91-132	6355-91-131	6355-91-132
OAS	Heckler & Koch P2000 3.5" BBL	STX Tactical	Black	6354-97-131	6354-97-132	6355-97-131	6355-97-132
Speed Loaders	Heckler & Koch P2000 US Version w/ ITI M3, TLR-1, TLR-1HL, SureFire X200/X300/X300U 3.5" BBL	STX Tactical	Black	6354-1972-131	6354-1972-132	6355-1972-131	6355-1972-132
Light Systems	Heckler & Koch VP9 4.09" BBL	STX Tactical	Black	6354-593-131	6354-593-132	6355-593-131	6355-593-132
Concealment Holsters	Heckler & Koch VP9 w/ ITI M3, TLR-1, TLR-1HL, SureFire X200/X300/X300U 4.09" BBL	STX Tactical	Black	6354-5932-131	6354-5932-132	6355-5932-131	6355-5932-132
Concealment Accessories	Sig Sauer P220, P226 4.41" BBL	STX Tactical	Black	6354-77-131	6354-77-132	6355-77-131	6355-77-132
Competition	Sig Sauer P220R DAK, P226R DAK w/ Bobbed Hammer; P220R DA/SA, P226R DA/SA w/ Full Size Hammer 4.41" BBL	STX Tactical	Black	6354-447-131	6354-447-132	6355-447-131	6355-447-132
Apparel	Sig Sauer P220R, P226R w/ ITI M3 Light TLR-1, TLR-1HL, SureFire X200/X300/X300U w/ Accessory Rails 4.41" BBL	STX Tactical	Black	6354-7742-131	6354-7742-132	6355-7742-131	6355-7742-132
Sales Support	Sig Sauer P225 3.86" BBL	STX Tactical	Black	6354-79-131	6354-79-132	6355-79-131	6355-79-132
Index/Price List	Sig Sauer P226R Elite 4.41" BBL	STX Tactical	Black	6354-477-131	6354-477-132	6355-477-131	6355-477-132
	Sig Sauer P228, P229 3.9" BBL	STX Tactical	Black	6354-74-131	6354-74-132	6355-74-131	6355-74-132
	Sig Sauer P229R w/ ITI M3 Light, TLR-1, TLR-1HL, SureFire X200/X300 3.9" BBL	STX Tactical	Black	6354-7442-131	6354-7442-132	6355-7442-131	6355-7442-132
	Sig Sauer P250 Compact 9mm, .40, .45 3.9" BBL	STX Tactical	Black	6354-750-131	6354-750-132	6355-750-131	6355-750-132
	Sig Sauer P250 9mm, .40, .45 4.7" BBL	STX Tactical	Black	6354-450-131	6354-450-132	6355-450-131	6355-450-132
	Sig Sauer SP2022 3.87" BBL	STX Tactical	Black	6354-278-131	6354-278-132	6355-278-131	6355-278-132

Tactical Holsters

6354/6355 ALS® TACTICAL HOLSTERS FOR: PISTOLS (continued)

GUN DESCRIPTION	FINISH*	COLOR	6354		6355 W/QUICK RELEASE	
			RIGHT	LEFT	RIGHT	LEFT
Sig Sauer P320 4.7" BBL	STX Tactical	Black	6354-450-131	6354-450-132	6355-450-131	6355-450-132
Sig Sauer P320 9/40 w/ ITI M3, TLR-1, TLR-1HL, SureFire X200/X300/X300U 4.7" BBL	STX Tactical	Black	6354-4502-131	6354-4502-132	6355-4502-131	6355-4502-132
Sig Sauer P320C 3.9" BBL	STX Tactical	Black	6354-750-131	6354-750-132	6355-750-131	6355-750-132
Smith & Wesson M&P 9mm, .40, .22LR 4.25" BBL	STX Tactical	Black	6354-219-131	6354-219-132	6355-219-131	6355-219-132
Smith & Wesson M&P 9mm, .40, w/ ITI M3, TLR-1, TLR-1HL, SureFire X200/X300/X300U 4.25" BBL	STX Tactical	Black	6354-2192-131	6354-2192-132	6355-2192-131	6355-2192-132
Smith & Wesson M&P 9L 5" BBL	STX Tactical	Black	6354-819-131	6354-819-132	6355-819-131	6355-819-132
Smith & Wesson M&P 9L w/ Thumb Safety 5" BBL	STX Tactical	Black	6354-820-131	6354-820-132	6355-820-131	6355-820-132
Smith & Wesson M&P 45C w/o Thumb Safety 4" BBL	STX Tactical	Black	6354-919-131	6354-919-132	6355-919-131	6355-919-132
Smith & Wesson M&P 45C w/ Thumb Safety 4" BBL	STX Tactical	Black	6354-920-131	6354-920-132	6355-920-131	6355-920-132
Smith & Wesson M&P 45C w/o Thumb Safety w/ ITI M3, TLR-1, TLR-1HL, SureFire X200/X300/X300U 4" BBL	STX Tactical	Black	6354-9192-131	6354-9192-132	6355-9192-131	6355-9192-132
Smith & Wesson M&P 45C w/ Thumb Safety w/ ITI M3, TLR-1, TLR-1HL, SureFire X200/X300/X300U 4" BBL	STX Tactical	Black	6354-9202-131	6354-9202-132	6355-9202-131	6355-9202-132
Smith & Wesson M&P .45 w/o Thumb Safety 4.5" BBL	STX Tactical	Black	6354-419-131	6354-419-132	6355-419-131	6355-419-132
Smith & Wesson M&P .45 w/o Thumb Safety w/ ITI M3, TLR-1, TLR-1HL, SureFire X200/X300/X300U 4.5" BBL	STX Tactical	Black	6354-4192-131	6354-4192-132	6355-4192-131	6355-4192-132
Smith & Wesson M&P .45 w/ & w/o Thumb Safety 4.5" BBL	STX Tactical	Black	6354-519-131	6354-519-132	6355-519-131	6355-519-132
Smith & Wesson M&P .45 w/ & w/o Thumb Safety w/ ITI M3, TLR-1, TLR-1HL, SureFire X200/X300/X300U 4.5" BBL	STX Tactical	Black	6354-5192-131	6354-5192-132	6355-5192-131	6355-5192-132
Smith & Wesson SW99 4" BBL	STX Tactical	Black	6354-84-131	6354-84-132	6355-84-131	6355-84-132
Smith & Wesson 4566TSW, w/ Picatinny Rails & ITI M3, TLR-1, TLR-1HL, SureFire X200/X300/X300U 4.25" BBL	STX Tactical	Black	6354-4302-131	6354-4302-132	6355-4302-131	6355-4302-132
Smith & Wesson 5946, 5943 DAO w/o Rails 4" BBL	STX Tactical	Black	6354-320-131	6354-320-132	6355-320-131	6355-320-132

How to Order
Duty Holsters
Duty Accessories
Tactical Holsters
Tactical Accessories
Duty Bats
QAS
Speed Loaders
Light Systems
Concealment Holsters
Concealment Accessories
Competition
Apparel
Sales Support
Index/ Price List

Tactical Holsters

6354/6355 ALS® TACTICAL HOLSTERS FOR: PISTOLS (continued)

	GUN DESCRIPTION	FINISH*	COLOR	6354		6355 W/QUICK RELEASE	
				RIGHT	LEFT	RIGHT	LEFT
Duty Holsters	Sphinx SDP-S 4.5" BBL	STX Tactical	Black	6354-281-131	6354-281-132	6355-281-131	6355-281-132
Duty Accessories	Sphinx SDP-S w/ WL1-AA, ITI M3, TLR-1 4.5" BBL	STX Tactical	Black	6354-28115-131	6354-28115-132	6355-28115-131	6355-28115-132
Tactical Holsters	Springfield Armory Operator 1911-A1 w/ Picatinny Light Rail 5" BBL	STX Tactical	Black	6354-56-131	6354-56-132	6355-56-131	6355-56-132
Tactical Accessories	Springfield Armory XD 9mm, .40, .45 3.8" BBL	STX Tactical	Black	6354-148-131	6354-148-132	6355-148-131	6355-148-132
Duty Belts	Springfield Armory XD 9mm, .40, .357, .45 5" BBL	STX Tactical	Black	6354-149-131	6354-149-132	6355-149-131	6355-149-132
OAS	Springfield Armory XD(M) 9mm 4.5" BBL	STX Tactical	Black	6354-145-131	6354-145-132	6355-145-131	6355-145-132
Speed Loaders	Springfield Armory XD(M) 9mm w/ ITI M3, TLR-1, TLR-1HL, SureFire X200/X300/X300U 4.5" BBL	STX Tactical	Black	6354-1452-131	6354-1452-132	6355-1452-131	6355-1452-132
Light Systems	Springfield Armory XD 9mm w/ ITI M3, TLR-1, TLR-1HL, SureFire X200/X300/X300U 4" BBL	STX Tactical	Black	6354-462-131	6354-462-132	6355-462-131	6355-462-132
Concealment Holsters	Springfield Armory XD .40, .45 w/ ITI M3, TLR-1, TLR-1HL, SureFire X200/X300/X300U 4" BBL	STX Tactical	Black	6354-1482-131	6354-1482-132	6355-1482-131	6355-1482-132
Concealment Accessories	Springfield Armory XD(M) .40, .45 4.5" BBL	STX Tactical	Black	6354-146-131	6354-146-132	6355-146-131	6355-146-132
Competition	Springfield Armory XD .45, 9mm, .40 w/ ITI M3, TLR-1HL, TLR-1, SureFire X200/X300/X300U 5" BBL	STX Tactical	Black	6354-1492-131	6354-1492-132	6355-1492-131	6355-1492-132
Apparel	Springfield Armory Operator 1911A-1 TLR-1HL, w/ SureFire X200/X300/X300U 5" BBL	STX Tactical	Black	6354-560-131	6354-560-132	6355-560-131	6355-560-132
Sales Support	Taurus PT840, PT809 4" BBL	STX Tactical	Black	6354-268-131	6354-268-132	6355-268-131	6355-268-132
Index/Price List	Walther P99 4" BBL	STX Tactical	Black	6354-84-131	6354-84-132	6355-84-131	6355-84-132
	Walther PPQ 4" BBL	STX Tactical	Black	6354-384-131	6354-384-132	6355-384-131	6355-384-132
	Walther P99C 4.5" BBL	STX Tactical	Black	6354-284-131	6354-284-132	6355-284-131	6355-284-132
	6006 ALS Guard*		Black	6006-1-21	6006-1-22		
	6007 ALS Hood Guard		Black	6007-21	6007-22		
	6007 ALS Hood Guard		Foliage Green	6007-541	6007-542		
	6007 ALS Hood Guard		Coyote Brown	6007-761	6007-762		
	6007 ALS Hood Guard		OD Green	6007-561	6007-562		
	6007 ALS Hood Guard		FDE Brown	6007-551	6007-552		
	6008* Hood Guard & ALS Guard		Black	6008-21	6008-22		
	6008* Hood Guard & ALS Guard		Foliage Green	6008-541	6008-542		
	6008* Hood Guard & ALS Guard		Coyote Brown	6008-761	6008-762		
	6008* Hood Guard & ALS Guard		OD Green	6008-561	6008-562		
	6007 ALS Hood Guard		FDE Brown	6008-551	6008-552		

*ALS Guard is Black Only

Tactical Holsters

6354/6355 RDS ALS® TACTICAL HOLSTERS FOR: PISTOLS



6354



6355

FEATURES

- ▶ ALS® (Automatic Locking System) secures holster once holstered
- ▶ Open-top design without SLS for quick retrieval of weapon
- ▶ For use with red dot optic-equipped weapons
- ▶ SafariLaminate™ thermal-molded construction protects handgun and sights
- ▶ Suede lined to protect handgun's finish
- ▶ Available in Cordura®, MultiCam®, Ranger Green, Coyote, Khaki, or Black finishes.
- ▶ Optic Hood Cover (optional)
- ▶ Standard double strap leg shroud with mounting holes for optional accessories
- ▶ Leg straps features silicone strips for non-slip traction

A complete list of tactical accessories begins on page 161

GUN DESCRIPTION	FINISH*	COLOR	6354RDS		6355RDS W/QUICK RELEASE	
			RIGHT	LEFT	RIGHT	LEFT
Glock 17/22 w/ ITI M3 Light, TLR-1, TLR-1HL SureFire X200/X300/ X300U, 4.5" BBL	Cordura® Cordura® Cordura® Cordura® Cordura® Tactical	MultiCam® Ranger Green Coyote Khaki Black Black	6354RDS-832-701	6354RDS-832-702	6355RDS-832-701	6355RDS-832-702
			6354RDS-832-731	6354RDS-832-732	6355RDS-832-731	6355RDS-832-732
			6354RDS-832-741	6354RDS-832-742	6355RDS-832-741	6355RDS-832-742
			6354RDS-832-751	6354RDS-832-752	6355RDS-832-751	6355RDS-832-752
			6354RDS-832-781	6354RDS-832-782	6355RDS-832-781	6355RDS-832-782
6354RDS-832-131	6354RDS-832-132	6355RDS-832-131	6355RDS-832-132			
Glock 19/23 w/ ITI M3 Light, TLR-1, TLR-1HL, SureFire X200/X300/ X300U, 4" BBL	Cordura® Cordura® Cordura® Cordura® Cordura® Tactical	MultiCam® Ranger Green Coyote Khaki Black Black	6354RDS-2832-701	6354RDS-2832-702	6355RDS-2832-701	6355RDS-2832-702
			6354RDS-2832-731	6354RDS-2832-732	6355RDS-2832-731	6355RDS-2832-732
			6354RDS-2832-741	6354RDS-2832-742	6355RDS-2832-741	6355RDS-2832-742
			6354RDS-2832-751	6354RDS-2832-752	6355RDS-2832-751	6355RDS-2832-752
			6354RDS-2832-781	6354RDS-2832-782	6355RDS-2832-781	6355RDS-2832-782
6354RDS-2832-131	6354RDS-2832-132	6355RDS-2832-131	6355RDS-2832-132			
Glock 34/35 w/ ITI M3 Light, TLR-1, TLR-1HL, SureFire X200/X300/ X300U, 5.32" BBL	Cordura® Cordura® Cordura® Cordura® Cordura® Tactical	MultiCam® Ranger Green Coyote Khaki Black Black	6354RDS-6832-701	6354RDS-6832-702	6355RDS-6832-701	6355RDS-6832-702
			6354RDS-6832-731	6354RDS-6832-732	6355RDS-6832-731	6355RDS-6832-732
			6354RDS-6832-741	6354RDS-6832-742	6355RDS-6832-741	6355RDS-6832-742
			6354RDS-6832-751	6354RDS-6832-752	6355RDS-6832-751	6355RDS-6832-752
			6354RDS-6832-781	6354RDS-6832-782	6355RDS-6832-781	6355RDS-6832-782
6354RDS-6832-131	6354RDS-6832-132	6355RDS-6832-131	6355RDS-6832-132			
Smith & Wesson M&P 9mm, .40 w/ITI M3 Light, TLR-1, TLR-1HL, SureFire X200/X300/ X300U, 4.25" BBL	Cordura® Cordura® Cordura® Cordura® Cordura® Tactical	MultiCam® Ranger Green Coyote Khaki Black Black	6354RDS-2192-701	6354RDS-2192-702	6355RDS-2192-701	6355RDS-2192-702
			6354RDS-2192-731	6354RDS-2192-732	6355RDS-2192-731	6355RDS-2192-732
			6354RDS-2192-741	6354RDS-2192-742	6355RDS-2192-741	6355RDS-2192-742
			6354RDS-2192-751	6354RDS-2192-752	6355RDS-2192-751	6355RDS-2192-752
			6354RDS-2192-781	6354RDS-2192-782	6355RDS-2192-781	6355RDS-2192-782
6354RDS-2192-131	6354RDS-2192-132	6355RDS-2192-131	6355RDS-2192-132			
Smith & Wesson M&P C.O.R.E w/ITI M3 Light, TLR-1, TLR-1HL, SureFire X200/X300/ X300U, 5" BBL	Cordura® Cordura® Cordura® Cordura® Cordura® Tactical	MultiCam® Ranger Green Coyote Khaki Black Black	6354RDS-8192-701	6354RDS-8192-702	6355RDS-8192-701	6355RDS-8192-702
			6354RDS-8192-731	6354RDS-8192-732	6355RDS-8192-731	6355RDS-8192-732
			6354RDS-8192-741	6354RDS-8192-742	6355RDS-8192-741	6355RDS-8192-742
			6354RDS-8192-751	6354RDS-8192-752	6355RDS-8192-751	6355RDS-8192-752
			6354RDS-8192-781	6354RDS-8192-782	6355RDS-8192-781	6355RDS-8192-782
6354RDS-8192-131	6354RDS-8192-132	6355RDS-8192-131	6355RDS-8192-132			

How to Order
Duty Holsters
Duty Accessories
Tactical Holsters
Tactical Accessories
Duty Belts
DAS
Speed Loaders
Light Systems
Concealment Holsters
Concealment Accessories
Competition
Apparel
Sales Support
Index/Price List

Tactical Holsters

6354DO ALS® OPTIC TACTICAL HOLSTER FOR: PISTOLS



FEATURES

- ▶ ALS® (Automatic Locking System) secures weapon once holstered; simple straight up draw once release is deactivated
- ▶ Open-top design without SLS for quick retrieval of weapon
- ▶ For use with red dot optic-equipped weapons
- ▶ Cordura® nylon wrap finish reduces Infrared (IR) Signature
- ▶ SafariLaminate™ thermal-molded construction protects handgun and sights
- ▶ Suede lined to protect handgun's finish
- ▶ Available in Cordura® Nylon, MultiCam®, Ranger Green, Coyote, Khaki, or Black finishes

GUN DESCRIPTION	FINISH	COLOR	RIGHT	LEFT
Glock 17, 22 4.5" BBL	Cordura®	MultiCam®	6354DO-83-701	6354DO-83-702
	Cordura®	Ranger Green	6354DO-83-731	6354DO-83-732
	Cordura®	Coyote	6354DO-83-741	6354DO-83-742
	Cordura®	Khaki	6354DO-83-751	6354DO-83-752
	Cordura®	Black	6354DO-83-781	6354DO-83-782
Glock 17, 22 with M3, TLR-1, or SureFire X200/X300, X300U, X300V, TLR-1HL, 4.5" BBL	Cordura®	MultiCam®	6354DO-832-701	6354DO-832-702
	Cordura®	Ranger Green	6354DO-832-731	6354DO-832-732
	Cordura®	Coyote	6354DO-832-741	6354DO-832-742
	Cordura®	Khaki	6354DO-832-751	6354DO-832-752
	Cordura®	Black	6354DO-832-781	6354DO-832-782
Glock 19, 23 4" BBL	Cordura®	MultiCam®	6354DO-283-701	6354DO-283-702
	Cordura®	Ranger Green	6354DO-283-731	6354DO-283-732
	Cordura®	Coyote	6354DO-283-741	6354DO-283-742
	Cordura®	Khaki	6354DO-283-751	6354DO-283-752
	Cordura®	Black	6354DO-283-781	6354DO-283-782
Glock 19, 23 with M3, TLR-1, or SureFire X200/X300, X300U, X300V, TLR-1HL, 4" BBL	Cordura®	MultiCam®	6354DO-2832-701	6354DO-2832-702
	Cordura®	Ranger Green	6354DO-2832-731	6354DO-2832-732
	Cordura®	Coyote	6354DO-2832-741	6354DO-2832-742
	Cordura®	Khaki	6354DO-2832-751	6354DO-2832-752
	Cordura®	Black	6354DO-2832-781	6354DO-2832-782
Glock 34, 35 5.32" BBL	Cordura®	MultiCam®	6354DO-683-701	6354DO-683-702
	Cordura®	Ranger Green	6354DO-683-731	6354DO-683-732
	Cordura®	Coyote	6354DO-683-741	6354DO-683-742
	Cordura®	Khaki	6354DO-683-751	6354DO-683-752
	Cordura®	Black	6354DO-683-781	6354DO-683-782
Glock 34, 35 with M3, TLR-1, or SureFire X200/X300, X300U, X300V, TLR-1HL, 5.32" BBL	Cordura®	MultiCam®	6354DO-6832-701	6354DO-6832-702
	Cordura®	Ranger Green	6354DO-6832-731	6354DO-6832-732
	Cordura®	Coyote	6354DO-6832-741	6354DO-6832-742
	Cordura®	Khaki	6354DO-6832-751	6354DO-6832-752
	Cordura®	Black	6354DO-6832-781	6354DO-6832-782

Tactical Holsters

6378USN ALS® LOW SIGNATURE HOLSTER FOR: PISTOLS

FEATURES

- ▶ Cordura® nylon-wrap reduces Infrared (IR) Signature
- ▶ ALS® (Automatic Locking System) secures weapon once holstered, simple straight up draw once release is deactivated
- ▶ Compact profile for minimal interference with other equipment
- ▶ ALS® retention is an open-top design that is drawn with a natural thumb only operation; no fingers in trigger guard area
- ▶ Optional ALS® Guard (Model 6006) available for increased security
- ▶ Genuine SafariLaminate™ construction with suede lining to help protect the weapon's finish
- ▶ Injection-molded paddle design is highly concealable and rides close to the body
- ▶ Injection-molded belt loop is user adjustable for cant angle and can be worn cross draw
- ▶ Adjustable injection-molded belt loop fits 1.5" (38mm), 1.75" (45mm), 2" (50mm), and 2.25" (58mm); please specify
- ▶ Available in MultiCam®, Ranger Green, Tan, and Kahki, and Black



PATENTED

GUN DESCRIPTION	FINISH*	COLOR	RIGHT	LEFT
Beretta M9, M9A1, 92F 4.9" BBL	Cordura®	MultiCam®	6378USN-73-701	6378USN-73-702
	Cordura®	Ranger Green	6378USN-73-731	6378USN-73-732
	Cordura®	Coyote	6378USN-73-741	6378USN-73-742
	Cordura®	Khaki	6378USN-73-751	6378USN-73-752
	Cordura®	Black	6378USN-73-781	6378USN-73-782
Glock 19, 23 4" BBL	Cordura®	MultiCam®	6378USN-283-701	6378USN-283-702
	Cordura®	Ranger Green	6378USN-283-731	6378USN-283-732
	Cordura®	Coyote	6378USN-283-741	6378USN-283-742
	Cordura®	Khaki	6378USN-283-751	6378USN-283-752
	Cordura®	Black	6378USN-283-781	6378USN-283-782
Glock 19, 23 with M3, TLR-1, TLR-1HL or SureFire X200/X300/X300U 4" BBL	Cordura®	MultiCam®	6378USN-2832-701	6378USN-2832-702
	Cordura®	Ranger Green	6378USN-2832-731	6378USN-2832-732
	Cordura®	Coyote	6378USN-2832-741	6378USN-2832-742
	Cordura®	Khaki	6378USN-2832-751	6378USN-2832-752
	Cordura®	Black	6378USN-2832-781	6378USN-2832-782
Sig Sauer P220, P226 4.41" BBL	Cordura®	MultiCam®	6378USN-77-701	6378USN-77-702
	Cordura®	Ranger Green	6378USN-77-731	6378USN-77-732
	Cordura®	Coyote	6378USN-77-741	6378USN-77-742
	Cordura®	Khaki	6378USN-77-751	6378USN-77-752
	Cordura®	Black	6378USN-77-781	6378USN-77-782

How to Order
Duty Holsters
Duty Accessories
Tactical Holsters
Tactical Accessories
Duty Bats
OAS
Speed Loaders
Light Systems
Concealment Holsters
Concealment Accessories
Competition
Apparel
Sales Support
Index/Price List

Tactical Holsters

6384/6385 ALS® OMV TACTICAL HOLSTERS FOR: PISTOLS



PATENTED

6384



PATENTED

6385 W/QUICK RELEASE

FEATURES

- ▶ ALS® (Automatic Locking System) secures weapon once holstered, simple straight up draw once release is deactivated
- ▶ Holster is optimized for use also on a MOLLE vest, with lower center of gravity than most other Safariland duty and tactical holsters for less pulling on vest
- ▶ Open-top design without SLS for quick retrieval of weapon
- ▶ Hood Guard is standard; optional ALS Guard available
- ▶ SafariLaminate™ thermal-molded construction protects handgun and sights
- ▶ Standard double strap leg shroud with mounting holes for optional accessories
- ▶ Suede lined to protect handgun's finish
- ▶ Available in STX Tactical® Black, Foliage Green, OD Green, Coyote Brown and FDE Brown finishes

A complete list of tactical accessories begins on page 161

*Available In These Additional Finishes:

Sample Code	6384-83-541
Foliage Green	6384-XX-54X
Coyote Brown	6384-XX-76X
OD Green	6384-XX-56X
FDE Brown	6384-XX-55X



ALS Guard – Unlocked



ALS Guard – Locked

Models 6384/6385 may be used in conjunction with the Drop Flex Adapter and can also be used with the QLS Systems.

The Drop Flex Adapter allows a user to wear a rig below the hip without shifting weight further down the leg and it will also keep the rig from sliding on belt. It can only be used with the single leg strap. (see page 147)

Description	Sample Part No.
DFA on Single Leg Strap w/ Model 6384	6384-XX-131-MS25
DFA on Single Leg Strap w/ QLS w/ Model 6384	6384-XX-131-MS19-MS27

Model 6385 uses the same part numbers as model 6384.

Model 6384/6385 Tactical Holsters include installed Hood Guard

Sample Code with ALS Guard Only:
6384-83-411-AG

Sample Code with Hood Guard & ALS Guard:
6384-83-411-AGH

Tactical Holsters

6384/6385 ALS® OMV TACTICAL HOLSTERS FOR: PISTOLS (continued)

GUN DESCRIPTION	FINISH*	COLOR	6384		6385 W/QUICK RELEASE	
			RIGHT	LEFT	RIGHT	LEFT
Beretta APX 9mm, .40 S&W 4.25" BBL	STX Tactical	Black	6384-677-131	6384-677-132	6385-677-131	6385-677-132
Beretta Px4 Storm 9mm, .40 4" BBL	STX Tactical	Black	6384-180-131	6384-180-132	6385-180-131	6385-180-132
Beretta 92F, 92FS, 92G, 96, 96G 4.9" BBL	STX Tactical	Black	6384-73-131	6384-73-132	6385-73-131	6385-73-132
Colt Government 1911 5" BBL	STX Tactical	Black	6384-53-131	6384-53-132	6385-53-131	6385-53-132
CZ P-07 3.8" BBL	STX Tactical	Black	6384-292-131	6384-292-132	6385-292-131	6385-292-132
FN FNS .40 4" BBL	STX Tactical	Black	6384-266-131	6384-266-132	6385-266-131	6385-266-132
Glock 17, 22 4.5" BBL	STX Tactical	Black	6384-83-131	6384-83-132	6385-83-131	6385-83-132
Glock 17, 22 w/ Dual Magazine Releases 4.5" BBL	STX Tactical	Black	6384-983-131	6384-983-132	6385-983-131	6385-983-132
Glock 17, 22 w/ ITI M3 Light, TLR-1, TLR-1HL, SureFire X200/X300/X300U 4.5" BBL	STX Tactical	Black	6384-832-131	6384-832-132	6385-832-131	6385-832-132
Glock 17, 22 w/ ITI M3X or TLR-1 4.5" BBL	STX Tactical	Black	6384-8311-131	6384-8311-132	6385-8311-131	6385-8311-132
Glock 17, 22 w/ GTL-10 Light Only GTL 21/22 Light/ Laser Combination GTL 51/52 Light/ Laser Combintion 4.5" BBL	STX Tactical	Black	6384-8310-131	6384-8310-132	6385-8310-131	6385-8310-132
Glock 19, 23 4" BBL 26, 27 3.5" BBL	STX Tactical	Black	6384-283-131	6384-283-132	6385-283-131	6385-283-132
Glock 19, 23 w/ ITI M3, TLR-1, TLR-1HL, SureFire X200/X300/X300U 4" BBL	STX Tactical	Black	6384-2832-131	6384-2832-132	6385-2832-131	6385-2832-132
Glock 20, 21 4.6" BBL	STX Tactical	Black	6384-383-131	6384-383-132	6385-383-131	6385-383-132
Glock 20, 21 w/ ITI M3, TLR-1, TLR-1HL, SureFire X200/X300/X300U 4.6" BBL	STX Tactical	Black	6384-3832-131	6384-3832-132	6385-3832-131	6385-3832-132
Glock 34, 35 5.32" BBL	STX Tactical	Black	6384-683-131	6384-683-132	6385-683-131	6385-683-132
Glock 34, 35 w/ ITI M3, TLR-1, TLR-1HL, SureFire X200/X300/X300U 5.32" BBL	STX Tactical	Black	6384-6832-131	6384-6832-132	6385-6832-131	6385-6832-132

How to Order
Duty Holsters
Duty Accessories
Tactical Holsters
Tactical Accessories
Duty Belts
QAS
Speed Loaders
Light Systems
Concealment Holsters
Concealment Accessories
Competition
Apparel
Sales Support
Index/ Price List

Tactical Holsters

6384/6385 ALS® OMV TACTICAL HOLSTERS FOR: PISTOLS (continued)

How to Order	Duty Holsters	GUN DESCRIPTION	FINISH*	COLOR	6384		6385 W/QUICK RELEASE	
					RIGHT	LEFT	RIGHT	LEFT
Duty Accessories		Glock 37 w/ ITI M3, TLR-1 SureFire X200/X300 4.5" BBL	STX Tactical	Black	6384-7832-131	6384-7832-132	6385-7832-131	6385-7832-132
Tactical Holsters		Glock 37 4.5" BBL	STX Tactical	Black	6384-783-131	6384-783-132	6385-783-131	6385-783-132
Tactical Accessories		Glock 41 5.31" BBL	STX Tactical	Black	6384-893-131	6384-893-132	6385-893-131	6385-893-132
Duty Belts		Glock 41 w/ ITI M3, TLR-1, TLR-1HL, SureFire X200/X300/X300U 5.31" BBL	STX Tactical	Black	6384-8932-131	6384-8932-132	6385-8932-131	6385-8932-132
OAS		Heckler & Koch P30 3.875" BBL	STX Tactical	Black	6384-295-131	6384-295-132	6385-295-131	6385-295-132
Speed Loaders		Heckler & Koch P30 w/ ITI M3, TLR-1, TLR-1HL, SureFire X200/X300/X300U 3.78" BBL	STX Tactical	Black	6384-2952-131	6384-2952-132	6385-2952-131	6385-2952-132
Light Systems		Heckler & Koch P30L w/ ITI M3, TLR-1, TLR-1HL, SureFire X200/X300/X300U 4.45" BBL	STX Tactical	Black	6384-3952-131	6384-3952-132	6385-3952-131	6385-3952-132
Concealment Holsters		Heckler & Koch USP 9/40 w/ TRL-3 4.25" BBL	STX Tactical	Black	6384-29116-131	6384-29116-132	6385-29116-131	6385-29116-132
Concealment Accessories		Heckler & Koch USP 9C 3.58" BBL	STX Tactical	Black	6384-291-131	6384-291-132	6385-291-131	6385-291-132
Competition		Heckler & Koch USP 9mm, .40 4.25" BBL	STX Tactical	Black	6384-91-131	6384-91-132	6385-91-131	6385-91-132
Apparel		Heckler & Koch P2000 3.5" BBL	STX Tactical	Black	6384-97-131	6384-97-132	6385-97-131	6385-97-132
Sales Support		Heckler & Koch P2000 US Version w/ ITI M3, TLR-1, TLR-1HL, SureFire X200/X300/X300U 3.5" BBL	STX Tactical	Black	6384-1972-131	6384-1972-132	6385-1972-131	6385-1972-132
Index/Price List		Heckler & Koch VP9 4.09" BBL	STX Tactical	Black	6384-593-131	6384-593-132	6385-593-131	6385-593-132
		Heckler & Koch VP9 w/ ITI M3, TLR-1, TLR-1HL, SureFire X200/X300/X300U 4.09" BBL	STX Tactical	Black	6384-5932-131	6384-5932-132	6385-5932-131	6385-5932-132
		Sig Sauer P220R, P226R 4.41" BBL	STX Tactical	Black	6384-77-131	6384-77-132	6385-77-131	6385-77-132
		Sig Sauer P220, P226 w/ ITI M3, TLR-1, TLR-1HL, SureFire X200/X300/X300U 4.41" BBL	STX Tactical	Black	6384-7742-131	6384-7742-132	6385-7742-131	6385-7742-132
		Sig Sauer P220R DAK, P226R DAK w/ Bobbed Hammer P220R DA/SA, P226R DA/SA w/ Full Size Hammer 4.41" BBL	STX Tactical	Black	6384-477-131	6384-477-132	6385-477-131	6385-477-132
		Sig Sauer P226R Elite 4.41" BBL	STX Tactical	Black	6384-477-131	6384-477-132	6385-477-131	6385-477-132

Tactical Holsters

6384/6385 ALS® OMV TACTICAL HOLSTERS FOR: PISTOLS (continued)

GUN DESCRIPTION	FINISH*	COLOR	6384		6385 W/QUICK RELEASE	
			RIGHT	LEFT	RIGHT	LEFT
Sig Sauer P228, P229 3.9" BBL	STX Tactical	Black	6384-74-131	6384-74-132	6385-74-131	6385-74-132
Sig Sauer P229R w/ ITI M3, TLR-1, TLR-1HL, SureFire X200/X300/X300U 3.9" BBL	STX Tactical	Black	6384-7442-131	6384-7442-132	6385-7442-131	6385-7442-132
Sig Sauer P229R DAK .40 w/ Bobbed Hammer P229R DA/SA .40 w/ Full Size Hammer 3.9" BBL	STX Tactical	Black	6384-447-131	6384-447-132	6385-447-131	6385-447-132
Sig Sauer P320 4.7" BBL	STX Tactical	Black	6384-450-131	6384-450-132	6385-450-131	6385-450-132
Sig Sauer P320 9/40 w/ ITI M3, TLR-1, TLR-1HL, SureFire X200/X300/X300U 4.7" BBL	STX Tactical	Black	6384-4502-131	6384-4502-132	6385-4502-131	6385-4502-132
Sig Sauer P320C 3.9" BBL	STX Tactical	Black	6384-750-131	6384-750-132	6385-750-131	6385-750-132
Sig Sauer SP2022 3.87" BBL	STX Tactical	Black	6384-278-131	6384-278-132	6385-278-131	6385-278-132
Smith & Wesson M&P 9mm, .40 4.25" BBL	STX Tactical	Black	6384-219-131	6384-219-132	6385-219-131	6385-219-132
Smith & Wesson M&P 9mm, .40 w/ ITI M3, TLR-1, TLR-1HL, SureFire X200/X300/X300U 4.25" BBL	STX Tactical	Black	6384-2192-131	6384-2192-132	6385-2192-131	6385-2192-132
Smith & Wesson M&P 9L 5" BBL	STX Tactical	Black	6384-819-131	6384-819-132	6385-819-131	6385-819-132
Smith & Wesson M&P 45C w/o Manual Thumb Safety 4" BBL	STX Tactical	Black	6384-919-131	6384-919-132	6385-919-131	6385-919-132
Smith & Wesson M&P 45C w/o Manual Thumb Safety w/ ITI M3, TLR-1, TLR-1HL, SureFire X200/X300/X300U 4" BBL	STX Tactical	Black	6384-9192-131	6384-9192-132	6385-9192-131	6385-9192-132
Smith & Wesson M&P .45 w/o Manual Thumb Safety 4.5" BBL	STX Tactical	Black	6384-419-131	6384-419-132	6385-419-131	6385-419-132
Smith & Wesson M&P .45 w/o Manual Thumb Safety w/ ITI M3, TLR-1, TLR-1HL, SureFire X200/X300/X300U 4.5" BBL	STX Tactical	Black	6384-4192-131	6384-4192-132	6385-4192-131	6385-4192-132
Smith & Wesson 4566TSW w/ Picatinny Rails w/ ITI M3, TLR-1, TLR-1HL, SureFire X200/X300/X300U 4.25" BBL	STX Tactical	Black	6384-4302-131	6384-4302-132	6385-4302-131	6385-4302-132
Smith & Wesson SW99 4" BBL	STX Tactical	Black	6384-84-131	6384-84-132	6385-84-131	6385-84-132

How to Order
Duty Holsters
Duty Accessories
Tactical Holsters
Tactical Accessories
Duty Bats
QAS
Speed Loaders
Light Systems
Concealment Holsters
Concealment Accessories
Competition
Apparel
Sales Support
Index/ Price List

Tactical Holsters

6384/6385 ALS® OMV TACTICAL HOLSTERS FOR: PISTOLS (continued)

How to Order	Duty Holsters	GUN DESCRIPTION	FINISH*	COLOR	6384		6385 W/QUICK RELEASE	
					RIGHT	LEFT	RIGHT	LEFT
Duty Accessories		Smith & Wesson 5946, 5943 DAO w/o Rails 4" BBL	STX Tactical	Black	6384-320-131	6384-320-132	6385-320-131	6385-320-132
Duty Accessories		Sphinx SDP-S 4.5" BBL	STX Tactical	Black	6384-281-131	6384-281-132	6385-281-131	6385-281-132
Tactical Holsters		Sphinx SDP-S w/ WL1-AA ITI M3, TLR-1 4.5" BBL	STX Tactical	Black	6384-28115-131	6384-28115-132	6385-28115-131	6385-28115-132
Tactical Accessories		Springfield Armory XD(M) 9mm 4.5" BBL	STX Tactical	Black	6384-145-131	6384-145-132	6385-145-131	6385-145-132
Tactical Accessories		Springfield Armory XD(M) .40 4.5" BBL	STX Tactical	Black	6384-146-131	6384-146-132	6385-146-131	6385-146-132
Duty Belts		Springfield Armory XD(M) 9mm w/ ITI M3, TLR-1, TLR-1HL, SureFire X200/X300/X300U 4.5" BBL	STX Tactical	Black	6384-1452-131	6384-1452-132	6385-1452-131	6385-1452-132
OAS		Springfield Armory XD(M) .40 w/ ITI M3, TLR-1, TLR-1HL, SureFire X200/X300/X300U 4.5" BBL	STX Tactical	Black	6384-1462-131	6384-1462-132	6385-1462-131	6385-1462-132
Speed Loaders		Springfield Armory 1911-A1 w/ Picatinny Light Rail 5" BBL	STX Tactical	Black	6384-56-131	6384-56-132	6385-56-131	6385-56-132
Light Systems		Springfield Armory Operator 1911-A1 w/ Picatinny Light Rail w/ SureFire X200/X300/X300U 5" BBL	STX Tactical	Black	6384-560-131	6384-560-132	6385-560-131	6385-560-132
Concealment Holsters		Taurus PT840, PT809 4" BBL	STX Tactical	Black	6384-268-131	6384-268-132	6385-268-131	6385-268-132
Concealment Accessories		Walther P99 4" BBL	STX Tactical	Black	6384-84-131	6384-84-132	6385-84-131	6385-84-132
Concealment Accessories		Walther P99C 3.3" BBL	STX Tactical	Black	6384-284-131	6384-284-132	6385-284-131	6385-284-132
Concealment Accessories		Walther PPO 4" BBL	STX Tactical	Black	6384-384-131	6384-384-132	6385-384-131	6385-384-132
Competition		6006 ALS Guard		Black	6006-1-21	6006-1-22		
Competition		6007 ALS Hood Guard		Black	6007-21	6007-22		
Competition		6007 ALS Hood Guard		Foliage Green	6007-541	6007-542		
Competition		6007 ALS Hood Guard		Coyote Brown	6007-761	6007-762		
Competition		6007 ALS Hood Guard		OD Green	6007-561	6007-562		
Competition		6007 ALS Hood Guard		FDE Brown	6007-551	6007-552		
Apparel		6008* Hood Guard & ALS Guard		Black	6008-21	6008-22		
Apparel		6008* Hood Guard & ALS Guard		Foliage Green	6008-541	6008-542		
Apparel		6008* Hood Guard & ALS Guard		Coyote Brown	6008-761	6008-762		
Apparel		6008* Hood Guard & ALS Guard		OD Green	6008-561	6008-562		
Apparel		6008* Hood Guard & ALS Guard		FDE Brown	6008-551	6008-552		
Sales Support		*ALS Guard is Black Only						
Index/Price List								

Tactical Holsters

6384/6385 RDS ALS® OMV TACTICAL HOLSTERS FOR: PISTOLS



PATENTED

6384



PATENTED

6385 W/QUICK RELEASE

FEATURES

- ▶ ALS® (Automatic Locking System) secures holster once holstered
- ▶ For use with red dot optic-equipped weapons
- ▶ "Holster is optimized for use also on a MOLLE vest, with lower center of gravity than most other Safariland duty and tactical holsters for less pulling on vest"
- ▶ Open-top design without SLS for quick retrieval of weapon
- ▶ SafariLaminate™ thermal-molded construction protects handgun and sights
- ▶ Suede lined to protect handgun's finish
- ▶ Available in Cordura® Nylon, MultiCam®, Ranger Green, Coyote, Khaki, or Black finishes.

A complete list of tactical accessories begins on page 161

Models 6384/6385RDS may be used in conjunction with the Drop Flex Adapter and can also be used with the QLS Systems.

The Drop Flex Adapter allows a user to wear a rig below the hip without shifting weight further down the leg and it will also keep the rig from sliding on belt. It can only be used with the single leg strap. (see page 147)

Description	Sample Part No.
DFA on Single Leg Strap w/ Model 6384	6384RDS-XX-131-MS25
DFA on Single Leg Strap w/ QLS w/ Model 6384RDS	6384RDS-XX-131-MS19-MS27

Model 6385RDS uses the same part numbers as model 6384RDS.

Model 6384/6385RDS Tactical Holsters include installed Hood Guard

Sample Code with ALS Guard Only:
6384RDS-83-411-AG

Sample Code with Hood Guard & ALS Guard:
6384RDS-83-411-AGH

How to Order
Duty Holsters
Duty Accessories
Tactical Holsters
Tactical Accessories
Duty Belts
QAS
Speed Loaders
Light Systems
Concealment Holsters
Concealment Accessories
Competition
Apparel
Sales Support
Index/Price List

Tactical Holsters

6384/6385 RDS ALS® OMV TACTICAL HOLSTERS FOR: PISTOLS (continued)

GUN DESCRIPTION	FINISH*	COLOR	6384RDS MID-RIDE		6385RDS HI-RIDE	
			RIGHT	LEFT	RIGHT	LEFT
Glock 17/22 w/ ITI M3 Light, TLR-1, TLR-1HL, SureFire X200/X300/X300U 4.5" BBL	Cordura® Cordura® Cordura® Cordura® Tactical	MultiCam® Ranger Green Coyote Khaki Black Black	6384RDS-832-701	6384RDS-832-702	6385RDS-832-701	6385RDS-832-702
			6384RDS-832-731	6384RDS-832-732	6385RDS-832-731	6385RDS-832-732
			6384RDS-832-741	6384RDS-832-742	6385RDS-832-741	6385RDS-832-742
			6384RDS-832-751	6384RDS-832-752	6385RDS-832-751	6385RDS-832-752
			6384RDS-832-781	6384RDS-832-782	6385RDS-832-781	6385RDS-832-782
6384RDS-832-131	6384RDS-832-132	6385RDS-832-131	6385RDS-832-132			
Glock 19/23 w/ITI M3 Light, TLR-1, TLR-1HL, SureFire X200/X300/X300U 4" BBL	Cordura® Cordura® Cordura® Cordura® Tactical	MultiCam® Ranger Green Coyote Khaki Black Black	6384RDS-2832-701	6384RDS-2832-702	6385RDS-2832-701	6385RDS-2832-702
			6384RDS-2832-731	6384RDS-2832-732	6385RDS-2832-731	6385RDS-2832-732
			6384RDS-2832-741	6384RDS-2832-742	6385RDS-2832-741	6385RDS-2832-742
			6384RDS-2832-751	6384RDS-2832-752	6385RDS-2832-751	6385RDS-2832-752
			6384RDS-2832-781	6384RDS-2832-782	6385RDS-2832-781	6385RDS-2832-782
6384RDS-2832-131	6384RDS-2832-132	6385RDS-2832-131	6385RDS-2832-132			
Glock 34/35 w/ITI M3 Light, TLR-1, TLR-1HL, SureFire X200/X300/X300U 5.32" BBL	Cordura® Cordura® Cordura® Cordura® Tactical	MultiCam® Ranger Green Coyote Khaki Black Black	6384RDS-6832-701	6384RDS-6832-702	6385RDS-6832-701	6385RDS-6832-702
			6384RDS-6832-731	6384RDS-6832-732	6385RDS-6832-731	6385RDS-6832-732
			6384RDS-6832-741	6384RDS-6832-742	6385RDS-6832-741	6385RDS-6832-742
			6384RDS-6832-751	6384RDS-6832-752	6385RDS-6832-751	6385RDS-6832-752
			6384RDS-6832-781	6384RDS-6832-782	6385RDS-6832-781	6385RDS-6832-782
6384RDS-6832-131	6384RDS-6832-132	6385RDS-6832-131	6385RDS-6832-132			
Smith & Wesson M&P 9mm, .40 w/ITI M3 Light, TLR-1, TLR-1HL, SureFire X200/X300/X300U, 4.25" BBL	Cordura® Cordura® Cordura® Cordura® Tactical	MultiCam® Ranger Green Coyote Khaki Black Black	6384RDS-2192-701	6384RDS-2192-702	6385RDS-2192-701	6385RDS-2192-702
			6384RDS-2192-731	6384RDS-2192-732	6385RDS-2192-731	6385RDS-2192-732
			6384RDS-2192-741	6384RDS-2192-742	6385RDS-2192-741	6385RDS-2192-742
			6384RDS-2192-751	6384RDS-2192-752	6385RDS-2192-751	6385RDS-2192-752
			6384RDS-2192-781	6384RDS-2192-782	6385RDS-2192-781	6385RDS-2192-782
6384RDS-2192-131	6384RDS-2192-132	6385RDS-2192-131	6385RDS-2192-132			
Smith & Wesson M&P C.O.R.E w/ITI M3 Light, TLR-1, TLR-1HL, SureFire X200/X300/X300U, 5" BBL	Cordura® Cordura® Cordura® Cordura® Tactical	MultiCam® Ranger Green Coyote Khaki Black Black	6384RDS-8192-701	6384RDS-8192-702	6385RDS-8192-701	6385RDS-8192-702
			6384RDS-8192-731	6384RDS-8192-732	6385RDS-8192-731	6385RDS-8192-732
			6384RDS-8192-741	6384RDS-8192-742	6385RDS-8192-741	6385RDS-8192-742
			6384RDS-8192-751	6384RDS-8192-752	6385RDS-8192-751	6385RDS-8192-752
			6384RDS-8192-781	6384RDS-8192-782	6385RDS-8192-781	6385RDS-8192-782
6384RDS-8192-131	6384RDS-8192-132	6385RDS-8192-131	6385RDS-8192-132			

Tactical Holsters

7004/7005 7TS™ SLS TACTICAL HOLSTERS FOR: PISTOLS



PATENT PENDING

7004

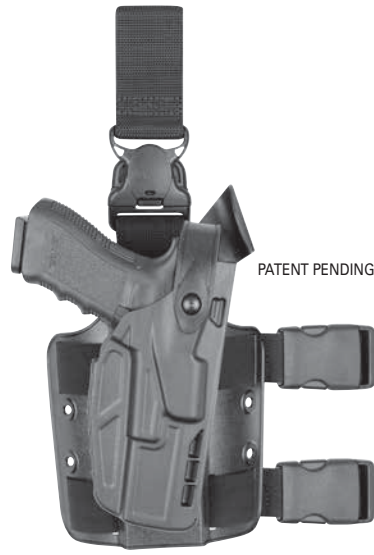

PATENT PENDING

7005 W/QUICK RELEASE

FEATURES

- ▶ SLS (Self Locking System) Rotating Hood
- ▶ Optional Sentry
- ▶ A proprietary nylon blend that is completely non-abrasive to a firearm's finish
- ▶ Raised stand-off surfaces in the interior of the holster to create air space around the weapon allowing dirt and moisture to quickly clear any contact with the firearms
- ▶ Very high heat and low cold tolerances structurally sound from 300° F to -50° F
- ▶ Can be submerged in water indefinitely and still maintain shape and function
- ▶ Standard double strap leg shroud with mounting holes for optional accessories
- ▶ Matte finish design to decrease reflection and can be maintained with a simple scouring pad
- ▶ Available in SafariSeven™ Plain Black and FDE Brown finishes

A complete list of tactical accessories begins on page 161

Models 7004/7005 Tactical Holsters include installed Hood Guard
 Sample Code with Sentry installed:
 7004-XX-411-S
 Sample Code with Hood Guard/Sentry installed:
 7004-XX-411-SH

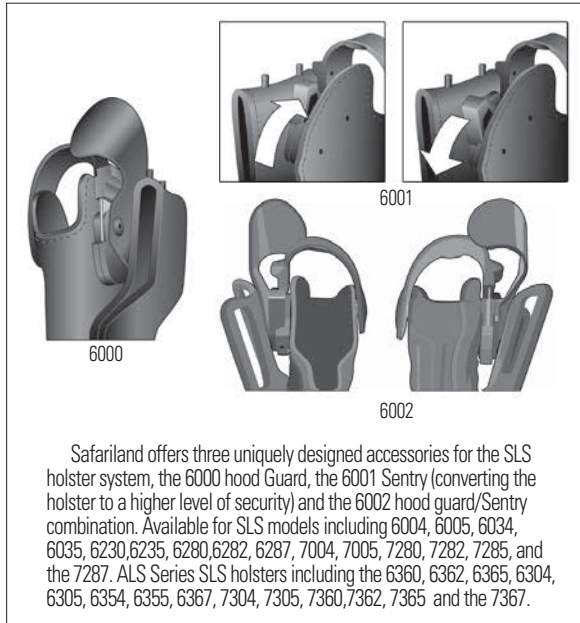

Safariland offers three uniquely designed accessories for the SLS holster system, the 6000 hood Guard, the 6001 Sentry (converting the holster to a higher level of security) and the 6002 hood guard/Sentry combination. Available for SLS models including 6004, 6005, 6034, 6035, 6230, 6235, 6280, 6282, 6287, 7004, 7005, 7280, 7282, 7285, and the 7287. ALS Series SLS holsters including the 6360, 6362, 6365, 6304, 6305, 6354, 6355, 6367, 7304, 7305, 7360, 7362, 7365 and the 7367.

Models 7004/7005 may be used in conjunction with the Drop Flex Adapter and can also be used with the QLS Systems.

The Drop Flex Adapter allows a user to wear a rig below the hip without shifting weight further down the leg and it will also keep the rig from sliding on belt. It can only be used with the single leg strap. (see page 147)

Description	Sample Part No.
DFA on Single Leg Strap w/ Model 7004	7004-XX-411-MS25
DFA on Single Leg Strap w/ QLS w/ Model 7004	7004-XX-411-MS19-MS27
Model 7005 uses the same part numbers as model 7004.	

How to Order
Duty Holsters
Duty Accessories
Tactical Holsters
Tactical Accessories
Duty Belts
QAS
Speed Loaders
Light Systems
Concealment Holsters
Concealment Accessories
Competition
Apparel
Sales Support
Index/Price List

Tactical Holsters

7004/7005 7TS™ SLS TACTICAL HOLSTERS FOR: PISTOLS (continued)

How to Order	Duty Holsters	GUN DESCRIPTION	FINISH	COLOR	7004		7005 W/QUICK RELEASE	
					RIGHT	LEFT	RIGHT	LEFT
Duty Accessories		Beretta 92F, 92FS, 92G, 96, 96G 4.9" BBL	SafariSeven Plain	Black	7004-73-411	7004-73-412	7005-73-411	7005-73-412
			SafariSeven Plain	FDE Brown	7004-73-551	7004-73-552	7005-73-551	7005-73-552
Duty Accessories		Glock 17, 22 4.5" BBL	SafariSeven Plain	Black	7004-83-411	7004-83-412	7005-83-411	7005-83-412
			SafariSeven Plain	FDE Brown	7004-83-551	7004-83-552	7005-83-551	7005-83-552
			SafariSeven Basket	Black	7004-83-481	7004-83-482	7005-83-481	7005-83-482
Tactical Holsters		Glock 17, 22 w/ ITI M3, TLR-1, TLR-1HL, SureFire X200/X300/X300U 4.5" BBL	SafariSeven Plain	Black	7004-832-411	7004-832-412	7005-832-411	7005-832-412
			SafariSeven Plain	FDE Brown	7004-832-551	7004-832-552	7005-832-551	7005-832-552
			SafariSeven Basket	Black	7004-832-481	7004-832-482	7005-832-481	7005-832-482
			SafariSeven Hi-Gloss	Black	7004-832-491	7004-832-492	7005-832-491	7005-832-492
Tactical Accessories		Glock 17,22 w/ XC-1 Surefire Light 4.5" BBL	SafariSeven Plain	Black	7004-8322-411	7004-8322-412	7005-8322-411	7005-8322-412
			SafariSeven Plain	FDE Brown	7004-8322-551	7004-8322-552	7005-8322-551	7005-8322-552
			SafariSeven Basket	Black	7004-8322-481	7004-8322-482	7005-8322-481	7005-8322-482
			SafariSeven Hi-Gloss	Black	7004-8322-491	7004-8322-492	7005-8322-491	7005-8322-492
Duty Belts		Glock 19, 23 4" BBL	SafariSeven Plain	Black	7004-283-411	7004-283-412	7005-283-411	7005-283-412
			SafariSeven Plain	FDE Brown	7004-283-551	7004-283-552	7005-283-551	7005-283-552
			SafariSeven Basket	Black	7004-283-481	7004-283-482	7005-283-481	7005-283-482
QAS		Glock 19, 23 w/ ITI M3, TLR-1, TLR-1HL, SureFire X200/X300/X300U 4" BBL	SafariSeven Plain	Black	7004-2832-411	7004-2832-412	7005-2832-411	7005-2832-412
			SafariSeven Plain	FDE Brown	7004-2832-551	7004-2832-552	7005-2832-551	7005-2832-552
			SafariSeven Basket	Black	7004-2832-481	7004-2832-482	7005-2832-481	7005-2832-482
			SafariSeven Hi-Gloss	Black	7004-2832-491	7004-2832-492	7005-2832-491	7005-2832-492
Speed Loaders		Glock 19,23 w/ XC-1 Surefire Light 4" BBL	SafariSeven Plain	Black	7004-28322-411	7004-28322-412	7005-28322-411	7005-28322-412
			SafariSeven Plain	FDE Brown	7004-28322-551	7004-28322-552	7005-28322-551	7005-28322-552
			SafariSeven Basket	Black	7004-28322-481	7004-28322-482	7005-28322-481	7005-28322-482
			SafariSeven Hi-Gloss	Black	7004-28322-491	7004-28322-492	7005-28322-491	7005-28322-492
Light Systems		Glock 20, 21 4.6" BBL	SafariSeven Plain	Black	7004-383-411	7004-383-412	7005-383-411	7005-383-412
			SafariSeven Plain	FDE Brown	7004-383-551	7004-383-552	7005-383-551	7005-383-552
			SafariSeven Basket	Black	7004-383-481	7004-383-482	7005-383-481	7005-383-482
			SafariSeven Hi-Gloss	Black	7004-383-491	7004-383-492	7005-383-491	7005-383-492
Light Systems		Glock 20, 21 w/ ITI M3, TLR-1, TLR-1HL, SureFire X200/X300/X300U 4.5" BBL	SafariSeven Plain	Black	7004-3832-411	7004-3832-412	7005-3832-411	7005-3832-412
			SafariSeven Plain	FDE Brown	7004-3832-551	7004-3832-552	7005-3832-551	7005-3832-552
			SafariSeven Basket	Black	7004-3832-481	7004-3832-482	7005-3832-481	7005-3832-482
			SafariSeven Hi-Gloss	Black	7004-3832-491	7004-3832-492	7005-3832-491	7005-3832-492
Concealment Holsters		Heckler & Koch P30 3.78" BBL	SafariSeven Plain	Black	7004-295-411	7004-295-412	7005-295-411	7005-295-412
			SafariSeven Plain	FDE Brown	7004-295-551	7004-295-552	7005-295-551	7005-295-552
Concealment Accessories		Heckler & Koch P2000 DAO 3.5" BBL	SafariSeven Plain	Black	7004-197-411	7004-197-412	7005-197-411	7005-197-412
			SafariSeven Plain	FDE Brown	7004-197-551	7004-197-552	7005-197-551	7005-197-552
Concealment Accessories		Heckler & Koch P2000 DA/SA 3.5" BBL	SafariSeven Plain	Black	7004-397-411	7004-397-412	7005-397-411	7005-397-412
			SafariSeven Plain	FDE Brown	7004-397-551	7004-397-552	7005-397-551	7005-397-552
Concealment Accessories		Heckler & Koch USP 9C/40C Bobbed Hammer 4.25" BBL	SafariSeven Plain	Black	7004-291-411	7004-291-412	7005-291-411	7005-291-412
			SafariSeven Plain	FDE Brown	7004-291-551	7004-291-552	7005-291-551	7005-291-552
Competition		Heckler & Koch USP 9C/40C Spurred Hammer 4.25" BBL	SafariSeven Plain	Black	7004-391-411	7004-391-412	7005-391-411	7005-391-412
			SafariSeven Plain	FDE Brown	7004-391-551	7004-391-552	7005-391-551	7005-391-552
Apparel		Heckler & Koch VP9 4.09" BBL	SafariSeven Plain	Black	7004-593-411	7004-593-412	7005-593-411	7005-593-412
			SafariSeven Plain	FDE Brown	7004-593-551	7004-593-552	7005-593-551	7005-593-552
Apparel		Ruger American 9mm, .40, 4.5" BBL	SafariSeven Plain	Black	7004-167-411	7004-167-412	7005-167-411	7005-167-412
			SafariSeven Plain	FDE Brown	7004-167-551	7004-167-552	7005-167-551	7005-167-552
Apparel		Ruger .45 ASP 4.5" BBL,	SafariSeven Plain	Black	7004-168-411	7004-168-412	7005-168-411	7005-168-412
			SafariSeven Plain	FDE Brown	7004-168-551	7004-168-552	7005-168-551	7005-168-552
Sales Support		Sig Sauer P220, P220R w/ITI M3, TLR-1, TLR-1HL, Surefire X200, X300, X300U 4.41" BBL	SafariSeven Plain	Black	7004-7702-411	7004-7702-412	7005-7702-411	7005-7702-412
			SafariSeven Plain	FDE Brown	7004-7702-551	7004-7702-552	7005-7702-551	7005-7702-552
			SafariSeven Basket	Black	7004-7702-481	7004-7702-482	7005-7702-481	7005-7702-482
			SafariSeven Hi-Gloss	Black	7004-7702-491	7004-7702-492	7005-7702-491	7005-7702-492

Tactical Holsters

7004/7005 7TS™ SLS TACTICAL HOLSTERS FOR: PISTOLS (continued)

GUN DESCRIPTION	FINISH	COLOR	7004		7005 W/QUICK RELEASE	
			RIGHT	LEFT	RIGHT	LEFT
Sig Sauer P220, P226, P220R, P226R, P226R MK25 9mm, .40 4.41" BBL P227 R3 .45 3.9" BBL	SafariSeven Plain	Black	7004-477-411	7004-477-412	7005-477-411	7005-477-412
	SafariSeven Plain	FDE Brown	7004-477-551	7004-477-552	7005-477-551	7005-477-552
Sig Sauer P226, P226R, P226R MK 9mm, .40 w/ITI M3, TLR-1, TLR-1HL, Surefire X200, X300, X300U 4.41" BBL	SafariSeven Plain	Black	7004-4772-411	7004-4772-412	7005-4772-411	7005-4772-412
	SafariSeven Plain	FDE Brown	7004-4772-551	7004-4772-552	7005-4772-551	7005-4772-552
	SafariSeven Basket	Black	7004-4772-481	7004-4772-482	7005-4772-481	7005-4772-482
	SafariSeven Hi-Gloss	Black	7004-4772-491	7004-4772-492	7005-4772-491	7005-4772-492
Sig Sauer P227, P227 R3 w/ITI M3, TLR-1, TLR-1HL, Surefire X200, X300, X300U 3.9" BBL	SafariSeven Plain	Black	7004-6772-411	7004-6772-412	7005-6772-411	7005-6772-412
	SafariSeven Plain	FDE Brown	7004-6772-551	7004-6772-552	7005-6772-551	7005-6772-552
	SafariSeven Basket	Black	7004-6772-481	7004-6772-482	7005-6772-481	7005-6772-482
	SafariSeven Hi-Gloss	Black	7004-6772-491	7004-6772-492	7005-6772-491	7005-6772-492
Sig Sauer P229R DAK, P229R E2 9mm, 3.9" BBL	SafariSeven Plain	Black	7004-474-411	7004-474-412	7005-474-411	7005-474-412
	SafariSeven Plain	FDE Brown	7004-474-551	7004-474-552	7005-474-551	7005-474-552
Sig Sauer P229, P229DAK, P229R 9mm w/ITI M3, TLR-1, TLR-1HL, Surefire X200, X300, X300U 3.9" BBL	SafariSeven Plain	Black	7004-4742-411	7004-4742-412	7005-4742-411	7005-4742-412
	SafariSeven Plain	FDE Brown	7004-4742-551	7004-4742-552	7005-4742-551	7005-4742-552
	SafariSeven Basket	Black	7004-4742-481	7004-4742-482	7005-4742-481	7005-4742-482
	SafariSeven Hi-Gloss	Black	7004-4742-491	7004-4742-492	7005-4742-491	7005-4742-492
Sig Sauer P229, P229R, .40 3.9" BBL	SafariSeven Plain	Black	7004-447-411	7004-447-412	7005-447-411	7005-447-412
	SafariSeven Plain	FDE Brown	7004-447-551	7004-447-552	7005-447-551	7005-447-552
Sig Sauer P229, P229R .40 w/ITI M3, TLR-1, TLR-1HL, Surefire X200, X300, X300U 3.9" BBL	SafariSeven Plain	Black	7004-4472-411	7004-4472-412	7005-4472-411	7005-4472-412
	SafariSeven Plain	FDE Brown	7004-4472-551	7004-4472-552	7005-4472-551	7005-4472-552
	SafariSeven Basket	Black	7004-4472-481	7004-4472-482	7005-4472-481	7005-4472-482
	SafariSeven Hi-Gloss	Black	7004-4472-491	7004-4472-492	7005-4472-491	7005-4472-492
Sig Sauer P320 Full Size 9mm, .40 4.7" BBL	SafariSeven Plain	Black	7004-450-411	7004-450-412	7005-450-411	7005-450-412
	SafariSeven Plain	FDE Brown	7004-450-551	7004-450-552	7005-450-551	7005-450-552
Sig Sauer P320 Full Size 9mm, .40 w/ITI M3, TLR-1, TLR-1HL Surefire X200/X300/X300U 4.7" BBL	SafariSeven Plain	Black	7004-4502-411	7004-4502-412	7005-4502-411	7005-4502-412
	SafariSeven Plain	FDE Brown	7004-4502-551	7004-4502-552	7005-4502-551	7005-4502-552
	SafariSeven Basket	Black	7004-4502-481	7004-4502-482	7005-4502-481	7005-4502-482
	SafariSeven Hi-Gloss	Black	7004-4502-491	7004-4502-492	7005-4502-491	7005-4502-492
Sig Sauer P320 Compact & Carry 9mm, .40 3.9" BBL	SafariSeven Plain	Black	7004-750-411	7004-750-412	7005-750-411	7005-750-412
	SafariSeven Plain	FDE Brown	7004-750-551	7004-750-552	7005-750-551	7005-750-552
Sig Sauer P320 Compact & Carry 9mm, .40 w/ITI M3, TLR-1, TLR-1HL, Surefire X200/X300/X300U 4.7" BBL	SafariSeven Plain	Black	7004-7502-411	7004-7502-412	7005-7502-411	7005-7502-412
	SafariSeven Plain	FDE Brown	7004-7502-551	7004-7502-552	7005-7502-551	7005-7502-552
	SafariSeven Basket	Black	7004-7502-481	7004-7502-482	7005-7502-481	7005-7502-482
	SafariSeven Hi-Gloss	Black	7004-7502-491	7004-7502-492	7005-7502-491	7005-7502-492
Sig Sauer P320 Full Size .45 3.9" BBL	SafariSeven Plain	Black	7004-451-411	7004-451-412	7005-451-411	7005-451-412
	SafariSeven Plain	FDE Brown	7004-451-551	7004-451-552	7005-451-551	7005-451-552
Sig Sauer P320 Full Size .45 w/ITI M3, TLR-1, TLR-1HL, Surefire X200/X300/X300U 3.9" BBL	SafariSeven Plain	Black	7004-4512-411	7004-4512-412	7005-4512-411	7005-4512-412
	SafariSeven Plain	FDE Brown	7004-4512-551	7004-4512-552	7005-4512-551	7005-4512-552
	SafariSeven Basket	Black	7004-4512-481	7004-4512-482	7005-4512-481	7005-4512-482
	SafariSeven Hi-Gloss	Black	7004-4512-491	7004-4512-492	7005-4512-491	7005-4512-492
Sig Sauer P320 Compact & Carry .45 3.9" BBL	SafariSeven Plain	Black	7004-751-411	7004-751-412	7005-751-411	7005-751-412
	SafariSeven Plain	FDE Brown	7004-751-551	7004-751-552	7005-751-551	7005-751-552
Sig Sauer P320 Compact & Carry .45 w/ITI M3, TLR-1, TLR-1HL, Surefire X200/X300/X300U 3.9" BBL	SafariSeven Plain	Black	7004-7512-411	7004-7512-412	7005-7512-411	7005-7512-412
	SafariSeven Plain	FDE Brown	7004-7512-551	7004-7512-552	7005-7512-551	7005-7512-552
	SafariSeven Basket	Black	7004-7512-481	7004-7512-482	7005-7512-481	7005-7512-482
	SafariSeven Hi-Gloss	Black	7004-7512-491	7004-7512-492	7005-7512-491	7005-7512-492

How to
Order
Duty
Holsters
Duty
Accessories
Tactical
Holsters
Tactical
Accessories
Duty
Bats
QAS
Speed
Loaders
Light
Systems
Concealment
Holsters
Concealment
Accessories
Competition
Apparel
Sales
Support
Index/
Price
List

Tactical Holsters

7004/7005 7TS™ SLS TACTICAL HOLSTERS FOR: PISTOLS (continued)

	GUN DESCRIPTION	FINISH	COLOR	7004		7005 W/QUICK RELEASE	
				RIGHT	LEFT	RIGHT	LEFT
Duty Holsters	Smith & Wesson M&P 9L, .40L 5" BBL	SafariSeven Plain	Black	7004-819-411	7004-819-412	7005-819-411	7005-819-412
Duty Accessories		SafariSeven Plain	FDE Brown	7004-819-551	7004-819-552	7005-819-551	7005-819-552
Duty Accessories	Smith & Wesson M&P 9L, .40L w/ITI M3, TLR-1, TLR-1HL, Surefire X200, X300, X300U 5" BBL	SafariSeven Plain	Black	7004-8192-411	7004-8192-412	7005-8192-411	7005-8192-412
Tactical Holsters		SafariSeven Plain	FDE Brown	7004-8192-551	7004-8192-552	7005-8192-551	7005-8192-552
Tactical Accessories		SafariSeven Basket	Black	7004-8192-481	7004-8192-482	7005-8192-481	7005-8192-482
Tactical Accessories	Smith & Wesson M&P 45 4.5" BBL	SafariSeven Plain	Black	7004-419-411	7004-419-412	7005-419-411	7005-419-412
Duty Belts		SafariSeven Plain	FDE Brown	7004-419-551	7004-419-552	7005-419-551	7005-419-552
OAS		SafariSeven Basket	Black	7004-419-481	7004-419-482	7005-419-481	7005-419-482
Speed Loaders	Smith & Wesson M&P 45C 4" BBL	SafariSeven Plain	Black	7004-919-411	7004-919-412	7005-919-411	7005-919-412
Light Systems		SafariSeven Plain	FDE Brown	7004-919-551	7004-919-552	7005-919-551	7005-919-552
Concealment Holsters		SafariSeven Basket	Black	7004-919-481	7004-919-482	7005-919-481	7005-919-482
Concealment Accessories	Smith & Wesson M&P .45 w/ITI M3, TLR-1, TLR-1HL, Surefire X200, X300, X300U 3.9" BBL	SafariSeven Plain	Black	7004-4192-411	7004-4192-412	7005-4192-411	7005-4192-412
Competition		SafariSeven Plain	FDE Brown	7004-4192-551	7004-4192-552	7005-4192-551	7005-4192-552
Apparel		SafariSeven Basket	Black	7004-4192-481	7004-4192-482	7005-4192-481	7005-4192-482
Sales Support	Smith & Wesson M&P 9mm, .40 w/ XC-1 Surefire Light 4.25" BBL	SafariSeven Plain	Black	7004-2192-411	7004-2192-412	7005-2192-411	7005-2192-412
Index/Price List		SafariSeven Plain	FDE Brown	7004-2192-551	7004-2192-552	7005-2192-551	7005-2192-552
		SafariSeven Basket	Black	7004-2192-481	7004-2192-482	7005-2192-481	7005-2192-482
	Smith & Wesson M&P 9/40 w/ ITI M3, TLR-1, TLR-1HL, SureFire X200/X300/X300U 4.25" BBL	SafariSeven Plain	Black	7004-2192-411	7004-2192-412	7005-2192-411	7005-2192-412
		SafariSeven Plain	FDE Brown	7004-2192-551	7004-2192-552	7005-2192-551	7005-2192-552
		SafariSeven Basket	Black	7004-2192-481	7004-2192-482	7005-2192-481	7005-2192-482
	Walther P99Q 4" BBL	SafariSeven Plain	Black	7004-384-411	7004-384-412	7005-384-411	7005-384-412
		SafariSeven Plain	FDE Brown	7004-384-551	7004-384-552	7005-384-551	7005-384-552
	Walther PP9Q 5" BBL	SafariSeven Plain	Black	7004-385-411	7004-385-412	7005-385-411	7005-385-412
		SafariSeven FDE	Brown	7004-385-551	7004-385-552	7005-385-551	7005-385-552

Tactical Holsters

7304/7305 7TS™ ALS®/SLS TACTICAL HOLSTERS FOR: PISTOLS



7304

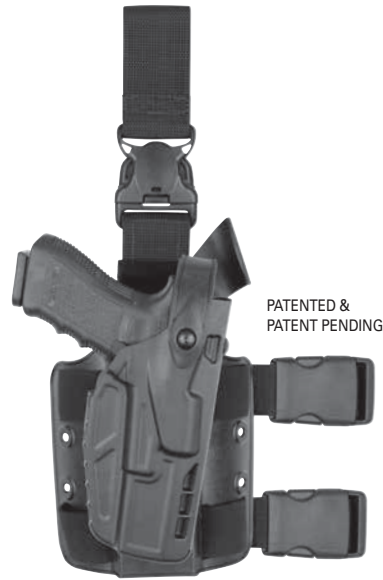

7305 W/QUICK RELEASE

FEATURES

- ▶ ALS® (Automatic Locking System) secures weapon once holstered, simple straight up draw once release is deactivated
- ▶ SLS (Self Locking System) Rotating Hood
- ▶ Optional Sentry
- ▶ A proprietary nylon blend that is completely non-abrasive to a firearm's finish
- ▶ Raised stand-off surfaces in the interior of the holster to create air space around the weapon allowing dirt and moisture to quickly clear any contact with the firearm
- ▶ Very high heat and low cold tolerances structurally sound from 300° F to -50° F
- ▶ Can be submerged in water indefinitely and still maintain shape and function
- ▶ Standard double strap leg shroud with mounting holes for optional accessories
- ▶ Matte finish designed to decrease reflection and can be maintained with a simple scouring pad
- ▶ Available in SafariSeven™ Plain Black and FDE Brown finishes

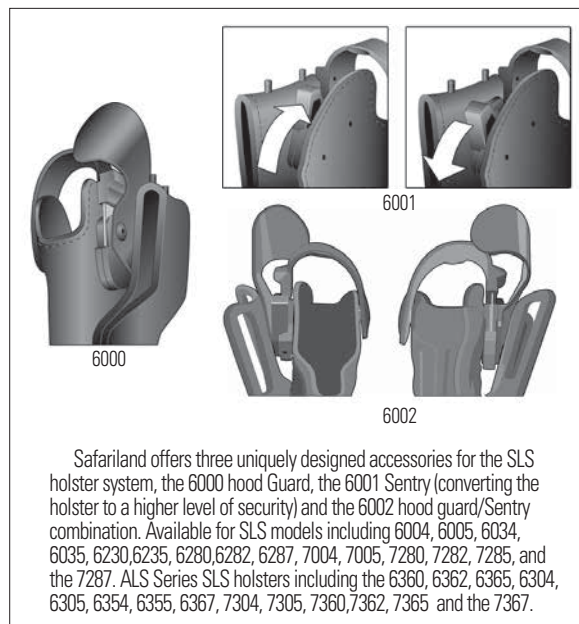

Safariland offers three uniquely designed accessories for the SLS holster system, the 6000 hood Guard, the 6001 Sentry (converting the holster to a higher level of security) and the 6002 hood guard/Sentry combination. Available for SLS models including 6004, 6005, 6034, 6035, 6230, 6235, 6280, 6282, 6287, 7004, 7005, 7280, 7282, 7285, and the 7287. ALS Series SLS holsters including the 6360, 6362, 6365, 6304, 6305, 6354, 6355, 6367, 7304, 7305, 7360, 7362, 7365 and the 7367.

A complete list of tactical accessories begins on page 161

Models 7304/7305 Tactical Holsters include installed Hood Guard
 Sample Code with Sentry installed:
 7304-83-411-S
 Sample Code with Sentry/Hood Guard installed:
 7304-83-411-SH

The Model 7304 may be used in conjunction with the Drop Flex Adapter and can also be used with the QLS Systems.

The Drop Flex Adapter allows a user to wear a rig below the hip without shifting weight further down the leg and it will also keep the rig from sliding on belt. It can only be used with the single leg strap. (see page 147)

Description	Sample Part No.
DFA on Single Leg Strap w/ Model 7304	7304-XX-411-MS25
DFA on Single Leg Strap w/ QLS w/ Model 7304	7304-XX-411-MS19-MS27

Model 7305 uses the same part numbers as model 7304.

How to Order
Duty Holsters
Duty Accessories
Tactical Holsters
Tactical Accessories
Duty Belts
QAS
Speed Loaders
Light Systems
Concealment Holsters
Concealment Accessories
Competition
Apparel
Sales Support
Index/Price List

Tactical Holsters

7304/7305 7TS™ ALS®/SLS TACTICAL HOLSTERS FOR: PISTOLS (continued)

	GUN DESCRIPTION	FINISH	COLOR	7304		7305 W/QUICK RELEASE	
				RIGHT	LEFT	RIGHT	LEFT
Duty Holsters	Glock 17, 22 4.5" BBL	SafariSeven Plain SafariSeven Plain SafariSeven Basket	Black FDE Brown Black	7304-83-411 7304-83-551 7304-83-481	7304-83-412 7304-83-552 7304-83-482	7305-83-411 7305-83-551 7305-83-481	7305-83-412 7305-83-552 7305-83-482
Duty Accessories	Glock 19, 23 4" BBL	SafariSeven Plain SafariSeven Plain SafariSeven Basket	Black FDE Brown Black	7304-283-411 7304-283-551 7304-283-481	7304-283-412 7304-283-552 7304-283-482	7305-283-411 7305-283-551 7305-283-481	7305-283-412 7305-283-552 7305-283-482
Tactical Holsters	Glock 17, 22 w/ ITI M3, TLR-1, TLR-1HL, SureFire X200/X300/X300U 4.5" BBL	SafariSeven Plain SafariSeven Plain SafariSeven Basket SafariSeven Hi-Gloss	Black FDE Brown Black Black	7304-832-411 7304-832-551 7304-832-481 7304-832-491	7304-832-412 7304-832-552 7304-832-482 7304-832-492	7305-832-411 7305-832-551 7305-832-481 7305-832-491	7305-832-412 7305-832-552 7305-832-482 7305-832-492
Tactical Accessories	Glock 17,22 w/ XC-1 Surefire Light 4.5" BBL	SafariSeven Plain SafariSeven Plain SafariSeven Basket SafariSeven Hi-Gloss	Black FDE Brown Black Black	7304-8322-411 7304-8322-551 7304-8322-481 7304-8322-491	7304-8322-412 7304-8322-552 7304-8322-482 7304-8322-492	7305-8322-411 7305-8322-551 7305-8322-481 7305-8322-491	7305-8322-412 7305-8322-552 7305-8322-482 7305-8322-492
Duty Belts	Glock 19, 23 w/ ITI M3, TLR-1, TLR-1HL, SureFire X200/X300/X300U 4" BBL	SafariSeven Plain SafariSeven Plain SafariSeven Basket SafariSeven Hi-Gloss	Black FDE Brown Black Black	7304-2832-411 7304-2832-551 7304-2832-481 7304-2832-491	7304-2832-412 7304-2832-552 7304-2832-482 7304-2832-492	7305-2832-411 7305-2832-551 7305-2832-481 7305-2832-491	7305-2832-412 7305-2832-552 7305-2832-482 7305-2832-492
OAS	Glock 19,23 w/ XC-1 Surefire Light 4" BBL	SafariSeven Plain SafariSeven Plain SafariSeven Basket SafariSeven Hi-Gloss	Black FDE Brown Black Black	7304-28322-411 7304-28322-551 7304-28322-481 7304-28322-491	7304-28322-412 7304-28322-552 7304-28322-482 7304-28322-492	7305-28322-411 7305-28322-551 7305-28322-481 7305-28322-491	7305-28322-412 7305-28322-552 7305-28322-482 7305-28322-492
Speed Loaders	Glock 20/21 4.6" BBL	SafariSeven Plain SafariSeven Plain SafariSeven Basket SafariSeven Hi-Gloss	Black FDE Brown Black Black	7304-383-411 7304-383-551 7304-383-481 7304-383-491	7304-383-412 7304-383-552 7304-383-482 7304-383-492	7305-383-411 7305-383-551 7305-383-481 7305-383-491	7305-383-412 7305-383-552 7305-383-482 7305-383-492
Light Systems	Glock 20, 21 w/ ITI M3, TLR-1, TLR-1HL, SureFire X200/X300/X300U 4.5" BBL	SafariSeven Plain SafariSeven Plain SafariSeven Basket SafariSeven Hi-Gloss	Black FDE Brown Black Black	7304-3832-411 7304-3832-551 7304-3832-481 7304-3832-491	7304-3832-412 7304-3832-552 7304-3832-482 7304-3832-492	7305-3832-411 7305-3832-551 7305-3832-481 7305-3832-491	7305-3832-412 7305-3832-552 7305-3832-482 7305-3832-492
Concealment Holsters	Heckler & Koch P30 3.78" BBL	SafariSeven Plain SafariSeven Plain	Black FDE Brown	7304-295-411 7304-295-551	7304-295-412 7304-295-552	7305-295-411 7305-295-551	7305-295-412 7305-295-552
Concealment Accessories	Heckler & Koch P2000 DAO 3.5" BBL	SafariSeven Plain SafariSeven Plain	Black FDE Brown	7304-197-411 7304-197-551	7304-197-412 7304-197-552	7305-197-411 7305-197-551	7305-197-412 7305-197-552
Competition	Heckler & Koch P2000 DA/SA 3.5" BBL	SafariSeven Plain SafariSeven Plain	Black FDE Brown	7304-397-411 7304-397-551	7304-397-412 7304-397-552	7305-397-411 7305-397-551	7305-397-412 7305-397-552
Apparel	Heckler & Koch USP 9C/40C DAO 4.25" BBL	SafariSeven Plain SafariSeven Plain	Black FDE Brown	7304-291-411 7304-291-551	7304-291-412 7304-291-552	7305-291-411 7305-291-551	7305-291-412 7305-291-552
Sales Support	Heckler & Koch USP 9C/40C DA/SA 4.25" BBL	SafariSeven Plain SafariSeven Plain	Black FDE Brown	7304-391-411 7304-391-551	7304-391-412 7304-391-552	7305-391-411 7305-391-551	7305-391-412 7305-391-552
Index/ Price List	Heckler & Koch VP9 4.09" BBL	SafariSeven Plain SafariSeven Plain	Black FDE Brown	7304-593-411 7304-593-551	7304-593-412 7304-593-552	7305-593-411 7305-593-551	7305-593-412 7305-593-552
	Ruger American 9mm, .40, 4.5" BBL	SafariSeven Plain SafariSeven Plain	Black FDE Brown	7304-167-411 7304-167-551	7304-167-412 7304-167-552	7305-167-411 7305-167-551	7305-167-412 7305-167-552
	Ruger .45 ASP 4.5" BBL	SafariSeven Plain SafariSeven Plain	Black FDE Brown	7304-168-411 7304-168-551	7304-168-412 7304-168-552	7305-168-411 7305-168-551	7305-168-412 7305-168-552
	Sig Sauer P220, P226, P220R, P226R, P226R MK25 9mm, .40 4.41" P227 R3 .45 3.9" BBL	SafariSeven Plain SafariSeven Plain	Black FDE Brown	7304-477-411 7304-477-551	7304-477-412 7304-477-552	7305-477-411 7305-477-551	7305-477-412 7305-477-552
	Sig Sauer P220, P220R w/ITI M3, TLR-1, TLR-1HL, Surefire X200, X300, X300U 4.41" BBL	SafariSeven Plain SafariSeven Plain SafariSeven Basket SafariSeven Hi-Gloss	Black FDE Brown Black Black	7304-7702-411 7304-7702-551 7304-7702-481 7304-7702-491	7304-7702-412 7304-7702-552 7304-7702-482 7304-7702-492	7305-7702-411 7305-7702-551 7305-7702-481 7305-7702-491	7305-7702-412 7305-7702-552 7305-7702-482 7305-7702-492

Tactical Holsters

7304/7305 7TS™ ALS®/SLS TACTICAL HOLSTERS FOR: PISTOLS (continued)

GUN DESCRIPTION	FINISH	COLOR	7304		7305 W/QUICK RELEASE	
			RIGHT	LEFT	RIGHT	LEFT
Sig Sauer P226, P226R, P226R MK 9mm, .40 w/ITI M3, TLR-1, TLR-1HL, Surefire X200, X300, X300U 4.41" BBL	SafariSeven Plain	Black	7304-4772-411	7304-4772-412	7305-4772-411	7305-4772-412
	SafariSeven Plain	FDE Brown	7304-4772-551	7304-4772-552	7305-4772-551	7305-4772-552
	SafariSeven Basket	Black	7304-4772-481	7304-4772-482	7305-4772-481	7305-4772-482
	SafariSeven Hi-Gloss	Black	7304-4772-491	7304-4772-492	7305-4772-491	7305-4772-492
Sig Sauer P227, P227 R3 w/ITI M3, TLR-1, TLR-1HL, Surefire X200, X300, X300U 3.9" BBL	SafariSeven Plain	Black	7304-6772-411	7304-6772-412	7305-6772-411	7305-6772-412
	SafariSeven Plain	FDE Brown	7304-6772-551	7304-6772-552	7305-6772-551	7305-6772-552
	SafariSeven Basket	Black	7304-6772-481	7304-6772-482	7305-6772-481	7305-6772-482
	SafariSeven Hi-Gloss	Black	7304-6772-491	7304-6772-492	7305-6772-491	7305-6772-492
Sig Sauer P229R DAK, P229R E2 9mm, 3.9" BBL	SafariSeven Plain	Black	7304-474-411	7304-474-412	7305-474-411	7305-474-412
	SafariSeven Plain	FDE Brown	7304-474-551	7304-474-552	7305-474-551	7305-474-552
Sig Sauer P229, P229DAK, P229R 9mm w/ITI M3, TLR-1, TLR-1HL, Surefire X200, X300, X300U 3.9" BBL	SafariSeven Plain	Black	7304-4742-411	7304-4742-412	7305-4742-411	7305-4742-412
	SafariSeven Plain	FDE Brown	7304-4742-551	7304-4742-552	7305-4742-551	7305-4742-552
	SafariSeven Basket	Black	7304-4742-481	7304-4742-482	7305-4742-481	7305-4742-482
	SafariSeven Hi-Gloss	Black	7304-4742-491	7304-4742-492	7305-4742-491	7305-4742-492
Sig Sauer P229, P229R, .40 3.9" BBL	SafariSeven Plain	Black	7304-447-411	7304-447-412	7305-447-411	7305-447-412
	SafariSeven Plain	FDE Brown	7304-447-551	7304-447-552	7305-447-551	7305-447-552
Sig Sauer P229, P229R .40 w/ITI M3, TLR-1, TLR-1HL, Surefire X200, X300, X300U 3.9" BBL	SafariSeven Plain	Black	7304-4472-411	7304-4472-412	7305-4472-411	7305-4472-412
	SafariSeven Plain	FDE Brown	7304-4472-551	7304-4472-552	7305-4472-551	7305-4472-552
	SafariSeven Basket	Black	7304-4472-481	7304-4472-482	7305-4472-481	7305-4472-482
	SafariSeven Hi-Gloss	Black	7304-4472-491	7304-4472-492	7305-4472-491	7305-4472-492
Sig Sauer P320 Full Size 9mm, .40 4.7" BBL	SafariSeven Plain	Black	7304-450-411	7304-450-412	7305-450-411	7305-450-412
	SafariSeven Plain	FDE Brown	7304-450-551	7304-450-552	7305-450-551	7305-450-552
Sig Sauer P320 Full Size 9mm, .40 w/ ITI M3, TLR-1, TLR-1HL Surefire X200/X300/X300U 4.7" BBL	SafariSeven Plain	Black	7304-4502-411	7304-4502-412	7305-4502-411	7305-4502-412
	SafariSeven Plain	FDE Brown	7304-4502-551	7304-4502-552	7305-4502-551	7305-4502-552
	SafariSeven Basket	Black	7304-4502-481	7304-4502-482	7305-4502-481	7305-4502-482
	SafariSeven Hi-Gloss	Black	7304-4502-491	7304-4502-492	7305-4502-491	7305-4502-492
Sig Sauer P320 Compact & Carry 9mm, .40 3.9" BBL	SafariSeven Plain	Black	7304-750-411	7304-750-412	7305-750-411	7305-750-412
	SafariSeven Plain	FDE Brown	7304-750-551	7304-750-552	7305-750-551	7305-750-552
Sig Sauer P320 Compact & Carry 9mm, .40 w/ ITI M3, TLR-1, TLR-1HL Surefire X200/X300/X300U 4.7" BBL	SafariSeven Plain	Black	7304-7502-411	7304-7502-412	7305-7502-411	7305-7502-412
	SafariSeven Plain	FDE Brown	7304-7502-551	7304-7502-552	7305-7502-551	7305-7502-552
	SafariSeven Basket	Black	7304-7502-481	7304-7502-482	7305-7502-481	7305-7502-482
	SafariSeven Hi-Gloss	Black	7304-7502-491	7304-7502-492	7305-7502-491	7305-7502-492
Sig Sauer P320 Full Size .45 3.9" BBL	SafariSeven Plain	Black	7304-451-411	7304-451-412	7305-451-411	7305-451-412
	SafariSeven Plain	FDE Brown	7304-451-551	7304-451-552	7305-451-551	7305-451-552
Sig Sauer P320 Full Size .45 w/ ITI M3, TLR-1, TLR-1HL Surefire X200/X300/X300U 3.9" BBL	SafariSeven Plain	Black	7304-4512-411	7304-4512-412	7305-4512-411	7305-4512-412
	SafariSeven Plain	FDE Brown	7304-4512-551	7304-4512-552	7305-4512-551	7305-4512-552
	SafariSeven Basket	Black	7304-4512-481	7304-4512-482	7305-4512-481	7305-4512-482
	SafariSeven Hi-Gloss	Black	7304-4512-491	7304-4512-492	7305-4512-491	7305-4512-492
Sig Sauer P320 Compact & Carry .45 3.9" BBL	SafariSeven Plain	Black	7304-751-411	7304-751-412	7305-751-411	7305-751-412
	SafariSeven Plain	FDE Brown	7304-751-551	7304-751-552	7305-751-551	7305-751-552
Sig Sauer P320 Compact & Carry .45 w/ ITI M3, TLR-1, TLR-1HL, Surefire X200/X300/X300U 3.9" BBL	SafariSeven Plain	Black	7304-7512-411	7304-7512-412	7305-7512-411	7305-7512-412
	SafariSeven Plain	FDE Brown	7304-7512-551	7304-7512-552	7305-7512-551	7305-7512-552
	SafariSeven Basket	Black	7304-7512-481	7304-7512-482	7305-7512-481	7305-7512-482
	SafariSeven Hi-Gloss	Black	7304-7512-491	7304-7512-492	7305-7512-491	7305-7512-492
Smith & Wesson M&P 45 4.5" BBL	SafariSeven Plain	Black	7304-419-411	7304-419-412	7305-419-411	7305-419-412
	SafariSeven Plain	FDE Brown	7304-419-551	7304-419-552	7305-419-551	7305-419-552
	SafariSeven Basket	Black	7304-419-481	7304-419-482	7305-419-481	7305-419-482
Smith & Wesson M&P .45 w/ITI M3, TLR-1, TLR-1HL, Surefire X200, X300, X300U 3.9" BBL	SafariSeven Plain	Black	7304-4192-411	7304-4192-412	7305-4192-411	7305-4192-412
	SafariSeven Plain	FDE Brown	7304-4192-551	7304-4192-552	7305-4192-551	7305-4192-552
	SafariSeven Basket	Black	7304-4192-481	7304-4192-482	7305-4192-481	7305-4192-482

How to Order
Duty Holsters
Duty Accessories
Tactical Holsters
Tactical Accessories
Duty Bats
QAS
Speed Loaders
Light Systems
Concealment Holsters
Concealment Accessories
Competition
Apparel
Sales Support
Index/Price List

Tactical Holsters

7304/7305 7TS™ ALS®/SLS TACTICAL HOLSTERS FOR: PISTOLS (continued)

GUN DESCRIPTION	FINISH	COLOR	7304		7305 W/QUICK RELEASE	
			RIGHT	LEFT	RIGHT	LEFT
Smith & Wesson M&P 9L, .40L 5" BBL	SafariSeven Plain	Black	7304-819-411	7304-819-412	7305-819-411	7305-819-412
	SafariSeven Plain	FDE Brown	7304-819-551	7304-819-552	7305-819-551	7305-819-552
Smith & Wesson M&P 9L, .40L w/ITI M3, TLR-1, TLR-1HL, Surefire X200, X300, X300U 5" BBL	SafariSeven Plain	Black	7304-8192-411	7304-8192-412	7305-8192-411	7305-8192-412
	SafariSeven Plain	FDE Brown	7304-8192-551	7304-8192-552	7305-8192-551	7305-8192-552
	SafariSeven Basket	Black	7304-8192-481	7304-8192-482	7305-8192-481	7305-8192-482
Smith & Wesson M&P 9mm, .40 4.25" BBL	SafariSeven Plain	Black	7304-219-411	7304-219-412	7305-219-411	7305-219-412
	SafariSeven Plain	FDE Brown	7304-219-551	7304-219-552	7305-219-551	7305-219-552
Smith & Wesson M&P 9mm, .40 w/ XC-1 Surefire Light 4.25" BBL	SafariSeven Plain	Black	7304-21922-411	7304-21922-412	7305-21922-411	7305-21922-412
	SafariSeven Plain	FDE Brown	7304-21922-551	7304-21922-552	7305-21922-551	7305-21922-552
	SafariSeven Basket	Black	7304-21922-481	7304-21922-482	7305-21922-481	7305-21922-482
	SafariSeven Hi-Gloss	Black	7304-21922-491	7304-21922-492	7305-21922-491	7305-21922-492
Smith & Wesson M&P 9/40 w/ ITI M3, TLR-1, SureFire X200/X300/X300U 4.25" BBL	SafariSeven Plain	Black	7304-2192-411	7304-2192-412	7305-2192-411	7305-2192-412
	SafariSeven Plain	FDE Brown	7304-2192-551	7304-2192-552	7305-2192-551	7305-2192-552
	SafariSeven Basket	Black	7304-2192-481	7304-2192-482	7305-2192-481	7305-2192-482
Smith & Wesson M&P 45C 4" BBL	SafariSeven Plain	Black	7304-919-411	7304-919-412	7305-919-411	7305-919-412
	SafariSeven Plain	FDE Brown	7304-919-551	7304-919-552	7305-919-551	7305-919-552
	SafariSeven Basket	Black	7304-919-481	7304-919-482	7305-919-481	7305-919-482
Walther P99Q 4" BBL	SafariSeven Plain	Black	7304-384-411	7304-384-412	7305-384-411	7305-384-412
	SafariSeven Plain	FDE Brown	7304-384-551	7304-384-552	7305-384-551	7305-384-552
Walther PP9Q 5" BBL	SafariSeven Plain	Black	7304-385-411	7304-385-412	7305-385-411	7305-385-412
	SafariSeven FDE	Brown	7304-385-551	7304-385-552	7305-385-551	7305-385-552

Tactical Holsters

7354/7355 7TS™ ALS® TACTICAL HOLSTER FOR: PISTOLS



7354



7355 W/QUICK RELEASE

FEATURES

- ▶ ALS® (Automatic Locking System) secures weapon once holstered, simple straight up draw once release is deactivated
- ▶ Open-top design without SLS for quick retrieval of weapon
- ▶ Constructed of SafariSeven™, a proprietary nylon blend that is completely non-abrasive to a firearm's finish
- ▶ Raised stand-off surfaces in the interior of the holster to create air space around the weapon allowing dirt and moisture to quickly clear any contact with the firearm
- ▶ Very high heat and low cold tolerances structurally sound from 300° F to -50° F
- ▶ Can be submerged in water indefinitely and still maintain shape and function
- ▶ Standard double strap leg shroud with mounting holes for optional accessories
- ▶ Matte finish designed to decrease reflection and can be maintained with a simple scouring pad
- ▶ Available in SafariSeven™ Plain Black and FDE Brown finishes

A complete list of tactical accessories begins on page 161

Models 7354/7355 Tactical Holsters include installed Hood Guard
 Sample Code with ALS Guard Only:
 7354-83-411-AG
 Sample Code with Hood Guard & ALS Guard:
 7354-83-411-AGH



ALS Guard – Unlocked

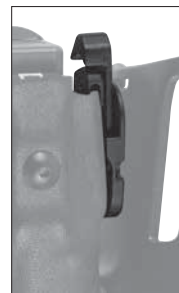

ALS Guard – Locked

Models 7354/7355 may be used in conjunction with the Drop Flex Adapter and can also be used with the QLS Systems.
 The Drop Flex Adapter allows a user to wear a rig below the hip without shifting weight further down the leg and it will also keep the rig from sliding on belt. It can only be used with the single leg strap.
 (see page 147)

Description	Sample Part No.
DFA on Single Leg Strap w/ Model 7354	7354-XX-411-MS25
DFA on Single Leg Strap w/ QLS w/ Model 7354	7354-XX-411-MS19-MS27

Model 7355 uses the same part numbers as model 7354.

How to Order
Duty Holsters
Duty Accessories
Tactical Holsters
Tactical Accessories
Duty Belts
QAS
Speed Loaders
Light Systems
Concealment Holsters
Concealment Accessories
Competition
Apparel
Sales Support
Index/Price List

Tactical Holsters

7354/7355 7TS™ ALS TACTICAL HOLSTERS FOR: PISTOLS (continued)

	GUN DESCRIPTION	FINISH	COLOR	7354		7355 W/QUICK RELEASE	
				RIGHT	LEFT	RIGHT	LEFT
Duty Holsters	Beretta 92F, 92FS, 92G, 96, 96G 4.9" BBL	SafariSeven Plain	Black	7354-73-411	7354-73-412	7355-73-411	7355-73-412
		SafariSeven Plain	FDE Brown	7354-73-551	7354-73-552	7355-73-551	7355-73-552
Duty Accessories	Glock 17, 22 4.5" BBL	SafariSeven Plain	Black	7354-83-411	7354-83-412	7355-83-411	7355-83-412
		SafariSeven Plain	FDE Brown	7354-83-551	7354-83-552	7355-83-551	7355-83-552
		SafariSeven Basket	Black	7354-83-481	7354-83-482	7355-83-481	7355-83-482
Tactical Holsters	Glock 17, 22 w/ ITI M3, TLR-1, TLR-1HL, SureFire X200/X300/X300U 4.5" BBL	SafariSeven Plain	Black	7354-832-411	7354-832-412	7355-832-411	7355-832-412
		SafariSeven Plain	FDE Brown	7354-832-551	7354-832-552	7355-832-551	7355-832-552
		SafariSeven Basket	Black	7354-832-481	7354-832-482	7355-832-481	7355-832-482
		SafariSeven Hi-Gloss	Black	7354-832-491	7354-832-492	7355-832-491	7355-832-492
Tactical Accessories	Glock 17,22 w/ XC-1 Surefire Light 4.5" BBL	SafariSeven Plain	Black	7354-8322-411	7354-8322-412	7355-8322-411	7355-8322-412
		SafariSeven Plain	FDE Brown	7354-8322-551	7354-8322-552	7355-8322-551	7355-8322-552
		SafariSeven Basket	Black	7354-8322-481	7354-8322-482	7355-8322-481	7355-8322-482
		SafariSeven Hi-Gloss	Black	7354-8322-491	7354-8322-492	7355-8322-491	7355-8322-492
Duty Belts	Glock 19, 23 4" BBL	SafariSeven Plain	Black	7354-283-411	7354-283-412	7355-283-411	7355-283-412
		SafariSeven Plain	FDE Brown	7354-283-551	7354-283-552	7355-283-551	7355-283-552
		SafariSeven Basket	Black	7354-283-481	7354-283-482	7355-283-481	7355-283-482
OAS	Glock 19, 23 w/ ITI M3, TLR-1, TLR-1HL, SureFire X200/X300/X300U 4" BBL	SafariSeven Plain	Black	7354-2832-411	7354-2832-412	7355-2832-411	7355-2832-412
		SafariSeven Plain	FDE Brown	7354-2832-551	7354-2832-552	7355-2832-551	7355-2832-552
		SafariSeven Basket	Black	7354-2832-481	7354-2832-482	7355-2832-481	7355-2832-482
		SafariSeven Hi-Gloss	Black	7354-2832-491	7354-2832-492	7355-2832-491	7355-2832-492
Speed Loaders	Glock 20, 21 4.6" BBL	SafariSeven Plain	Black	7354-383-411	7354-383-412	7355-383-411	7355-383-412
		SafariSeven Plain	FDE Brown	7354-383-551	7354-383-552	7355-383-551	7355-383-552
		SafariSeven Basket	Black	7354-383-481	7354-383-482	7355-383-481	7355-383-482
		SafariSeven Hi-Gloss	Black	7354-383-491	7354-383-492	7355-383-491	7355-383-492
Light Systems	Glock 20, 21 w/ ITI M3, TLR-1, TLR-1HL, SureFire X200/X300/X300U 4.5" BBL	SafariSeven Plain	Black	7354-3832-411	7354-3832-412	7355-3832-411	7355-3832-412
		SafariSeven Plain	FDE Brown	7354-3832-551	7354-3832-552	7355-3832-551	7355-3832-552
		SafariSeven Basket	Black	7354-3832-481	7354-3832-482	7355-3832-481	7355-3832-482
		SafariSeven Hi-Gloss	Black	7354-3832-491	7354-3832-492	7355-3832-491	7355-3832-492
Concealment Holsters	Heckler & Koch P30 3.78" BBL	SafariSeven Plain	Black	7354-295-411	7354-295-412	7355-295-411	7355-295-412
		SafariSeven Plain	FDE Brown	7354-295-551	7354-295-552	7355-295-551	7355-295-552
Concealment Accessories	Heckler & Koch P2000 DAO 3.5" BBL	SafariSeven Plain	Black	7354-197-411	7354-197-412	7355-197-411	7355-197-412
		SafariSeven Plain	FDE Brown	7354-197-551	7354-197-552	7355-197-551	7355-197-552
Competition	Heckler & Koch P2000 DA/SA 3.5" BBL	SafariSeven Plain	Black	7354-397-411	7354-397-412	7355-397-411	7355-397-412
		SafariSeven Plain	FDE Brown	7354-397-551	7354-397-552	7355-397-551	7355-397-552
Apparel	Heckler & Koch USP 9C/40C DAO 4.25" BBL	SafariSeven Plain	Black	7354-291-411	7354-291-412	7355-291-411	7355-291-412
		SafariSeven Plain	FDE Brown	7354-291-551	7354-291-552	7355-291-551	7355-291-552
Sales Support	Heckler & Koch USP 9C/40C DA/SA 4.25" BBL	SafariSeven Plain	Black	7354-391-411	7354-391-412	7355-391-411	7355-391-412
		SafariSeven Plain	FDE Brown	7354-391-551	7354-391-552	7355-391-551	7355-391-552
Index/Price List	Heckler & Koch VP9 4.09" BBL	SafariSeven Plain	Black	7354-593-411	7354-593-412	7355-593-411	7355-593-412
		SafariSeven Plain	FDE Brown	7354-593-551	7354-593-552	7355-593-551	7355-593-552
Sales Support	Ruger American 9mm, .40, 4.5" BBL	SafariSeven Plain	Black	7354-167-411	7354-167-412	7355-167-411	7355-167-412
		SafariSeven Plain	FDE Brown	7354-167-551	7354-167-552	7355-167-551	7355-167-552
Sales Support	Ruger .45 ASP 4.5" BBL	SafariSeven Plain	Black	7354-168-411	7354-168-412	7355-168-411	7355-168-412
		SafariSeven Plain	FDE Brown	7354-168-551	7354-168-552	7355-168-551	7355-168-552
Sales Support	Sig Sauer P220, P226, P220R, P226R, P226R MK25 9mm, .40 4.41" BBL P227 R3 .45 3.9" BBL	SafariSeven Plain	Black	7354-477-411	7354-477-412	7355-477-411	7355-477-412
		SafariSeven Plain	FDE Brown	7354-477-551	7354-477-552	7355-477-551	7355-477-552
Sales Support	Sig Sauer P220, P220R w/ITI M3, TLR-1, TLR-1HL, Surefire X200, X300, 4.41" BBL	SafariSeven Plain	Black	7354-7702-411	7354-7702-412	7355-7702-411	7355-7702-412
		SafariSeven Plain	FDE Brown	7354-7702-551	7354-7702-552	7355-7702-551	7355-7702-552
		SafariSeven Basket	Black	7354-7702-481	7354-7702-482	7355-7702-481	7355-7702-482
		SafariSeven Hi-Gloss	Black	7354-7702-491	7354-7702-492	7355-7702-491	7355-7702-492

Tactical Holsters

7354/7355 7TS™ ALS TACTICAL HOLSTERS FOR: PISTOLS (continued)

GUN DESCRIPTION	FINISH	COLOR	7354		7355 W/QUICK RELEASE	
			RIGHT	LEFT	RIGHT	LEFT
Sig Sauer P226, P226R, P226R MK 9mm, .40 w/ITI M3, TLR-1, TLR-1HL, Surefire X200, X300, X300U 4.41" BBL	SafariSeven Plain	Black	7354-4772-411	7354-4772-412	7355-4772-411	7355-4772-412
	SafariSeven Plain	FDE Brown	7354-4772-551	7354-4772-552	7355-4772-551	7355-4772-552
	SafariSeven Basket	Black	7354-4772-481	7354-4772-482	7355-4772-481	7355-4772-482
	SafariSeven Hi-Gloss	Black	7354-4772-491	7354-4772-492	7355-4772-491	7355-4772-492
Sig Sauer P227, P227 R3 w/ITI M3, TLR-1, TLR-1HL, Surefire X200, X300, X300U 3.9" BBL	SafariSeven Plain	Black	7354-6772-411	7354-6772-412	7355-6772-411	7355-6772-412
	SafariSeven Plain	FDE Brown	7354-6772-551	7354-6772-552	7355-6772-551	7355-6772-552
	SafariSeven Basket	Black	7354-6772-481	7354-6772-482	7355-6772-481	7355-6772-482
	SafariSeven Hi-Gloss	Black	7354-6772-491	7354-6772-492	7355-6772-491	7355-6772-492
Sig Sauer P229R DAK, P229R E2 9mm, 3.9" BBL	SafariSeven Plain	Black	7354-474-411	7354-474-412	7355-474-411	7355-474-412
	SafariSeven Plain	FDE Brown	7354-474-551	7354-474-552	7355-474-551	7355-474-552
Sig Sauer P229DAK, P229R 9mm w/ITI M3, TLR-1, TLR-1HL, Surefire X200, X300, X300U 3.9" BBL	SafariSeven Plain	Black	7354-4742-411	7354-4742-412	7355-4742-411	7355-4742-412
	SafariSeven Plain	FDE Brown	7354-4742-551	7354-4742-552	7355-4742-551	7355-4742-552
	SafariSeven Basket	Black	7354-4742-481	7354-4742-482	7355-4742-481	7355-4742-482
	SafariSeven Hi-Gloss	Black	7354-4742-491	7354-4742-492	7355-4742-491	7355-4742-492
Sig Sauer P229, P229R, .40 3.9" BBL	SafariSeven Plain	Black	7354-447-411	7354-447-412	7355-447-411	7355-447-412
	SafariSeven Plain	FDE Brown	7354-447-551	7354-447-552	7355-447-551	7355-447-552
Sig Sauer P229, P229R .40 w/ITI M3, TLR-1, TLR-1HL, Surefire X200, X300, X300U 3.9" BBL	SafariSeven Plain	Black	7354-4472-411	7354-4472-412	7355-4472-411	7355-4472-412
	SafariSeven Plain	FDE Brown	7354-4472-551	7354-4472-552	7355-4472-551	7355-4472-552
	SafariSeven Basket	Black	7354-4472-481	7354-4472-482	7355-4472-481	7355-4472-482
	SafariSeven Hi-Gloss	Black	7354-4472-491	7354-4472-492	7355-4472-491	7355-4472-492
Sig Sauer P320 Full Size 9mm, .40 4.7" BBL	SafariSeven Plain	Black	7354-450-411	7354-450-412	7355-450-411	7355-450-412
	SafariSeven Plain	FDE Brown	7354-450-551	7354-450-552	7355-450-551	7355-450-552
Sig Sauer P320 Full Size 9mm, .40 w/ITI M3, TLR-1, TLR-1HL, Surefire X200/X300/X300U 4.7" BBL	SafariSeven Plain	Black	7354-4502-411	7354-4502-412	7355-4502-411	7355-4502-412
	SafariSeven Plain	FDE Brown	7354-4502-551	7354-4502-552	7355-4502-551	7355-4502-552
	SafariSeven Basket	Black	7354-4502-481	7354-4502-482	7355-4502-481	7355-4502-482
	SafariSeven Hi-Gloss	Black	7354-4502-491	7354-4502-492	7355-4502-491	7355-4502-492
Sig Sauer P320 Compact & Carry 9mm, .40 3.9" BBL	SafariSeven Plain	Black	7354-750-411	7354-750-412	7355-750-411	7355-750-412
	SafariSeven Plain	FDE Brown	7354-750-551	7354-750-552	7355-750-551	7355-750-552
Sig Sauer P320 Compact & Carry 9mm, .40 w/ITI M3, TLR-1, TLR-1HL, Surefire X200/X300/X300U 4.7" BBL	SafariSeven Plain	Black	7354-7502-411	7354-7502-412	7355-7502-411	7355-7502-412
	SafariSeven Plain	FDE Brown	7354-7502-551	7354-7502-552	7355-7502-551	7355-7502-552
	SafariSeven Basket	Black	7354-7502-481	7354-7502-482	7355-7502-481	7355-7502-482
	SafariSeven Hi-Gloss	Black	7354-7502-491	7354-7502-492	7355-7502-491	7355-7502-492
Sig Sauer P320 Full Size .45 3.9" BBL	SafariSeven Plain	Black	7354-451-411	7354-451-412	7355-451-411	7355-451-412
	SafariSeven Plain	FDE Brown	7354-451-551	7354-451-552	7355-451-551	7355-451-552
Sig Sauer P320 Full Size .45 w/ITI M3, TLR-1, TLR-1HL, Surefire X200/X300/X300U 3.9" BBL	SafariSeven Plain	Black	7354-4512-411	7354-4512-412	7355-4512-411	7355-4512-412
	SafariSeven Plain	FDE Brown	7354-4512-551	7354-4512-552	7355-4512-551	7355-4512-552
	SafariSeven Basket	Black	7354-4512-481	7354-4512-482	7355-4512-481	7355-4512-482
	SafariSeven Hi-Gloss	Black	7354-4512-491	7354-4512-492	7355-4512-491	7355-4512-492
Sig Sauer P320 Compact & Carry .45 3.9" BBL	SafariSeven Plain	Black	7354-751-411	7354-751-412	7355-751-411	7355-751-412
	SafariSeven Plain	FDE Brown	7354-751-551	7354-751-552	7355-751-551	7355-751-552
Sig Sauer P320 Compact & Carry .45 w/ITI M3, TLR-1, TLR-1HL, Surefire X200/X300/X300U 3.9" BBL	SafariSeven Plain	Black	7354-7512-411	7354-7512-412	7355-7512-411	7355-7512-412
	SafariSeven Plain	FDE Brown	7354-7512-551	7354-7512-552	7355-7512-551	7355-7512-552
	SafariSeven Basket	Black	7354-7512-481	7354-7512-482	7355-7512-481	7355-7512-482
	SafariSeven Hi-Gloss	Black	7354-7512-491	7354-7512-492	7355-7512-491	7355-7512-492
Smith & Wesson M&P 45 4.5" BBL	SafariSeven Plain	Black	7354-419-411	7354-419-412	7355-419-411	7355-419-412
	SafariSeven Plain	FDE Brown	7354-419-551	7354-419-552	7355-419-551	7355-419-552
	SafariSeven Basket	Black	7354-419-481	7354-419-482	7355-419-481	7355-419-482
Smith & Wesson M&P .45 w/ITI M3, TLR-1, TLR-1HL, Surefire X200, X300, X300U 3.9" BBL	SafariSeven Plain	Black	7354-4192-411	7354-4192-412	7355-4192-411	7355-4192-412
	SafariSeven Plain	FDE Brown	7354-4192-551	7354-4192-552	7355-4192-551	7355-4192-552
	SafariSeven Basket	Black	7354-4192-481	7354-4192-482	7355-4192-481	7355-4192-482

How to Order
Duty Holsters
Duty Accessories
Tactical Holsters
Tactical Accessories
Duty Bats
QAS
Speed Loaders
Light Systems
Concealment Holsters
Concealment Accessories
Competition
Apparel
Sales Support
Index/Price List

Tactical Holsters

7354/7355 7TS™ ALS TACTICAL HOLSTERS FOR: PISTOLS (continued)

GUN DESCRIPTION	FINISH	COLOR	7354		7355 W/QUICK RELEASE	
			RIGHT	LEFT	RIGHT	LEFT
Smith & Wesson M&P 9L, .40L 5" BBL	SafariSeven Plain	Black	7354-819-411	7354-819-412	7355-819-411	7355-819-412
	SafariSeven Plain	FDE Brown	7354-819-551	7354-819-552	7355-819-551	7355-819-552
Smith & Wesson M&P 9L, .40L w/ITI M3, TLR-1, TLR-1HL, Surefire X200, X300, X300U 5" BBL	SafariSeven Plain	Black	7354-8192-411	7354-8192-412	7355-8192-411	7355-8192-412
	SafariSeven Plain	FDE Brown	7354-8192-551	7354-8192-552	7355-8192-551	7355-8192-552
	SafariSeven Basket	Black	7354-8192-481	7354-8192-482	7355-8192-481	7355-8192-482
Smith & Wesson M&P 9mm, .40 4.25" BBL	SafariSeven Plain	Black	7354-219-411	7354-219-412	7355-219-411	7355-219-412
	SafariSeven Plain	FDE Brown	7354-219-551	7354-219-552	7355-219-551	7355-219-552
Smith & Wesson M&P 9mm, .40 w/ XC-1 Surefire Light 4.25" BBL	SafariSeven Plain	Black	7354-21922-411	7354-21922-412	7355-21922-411	7355-21922-412
	SafariSeven Plain	FDE Brown	7354-21922-551	7354-21922-552	7355-21922-551	7355-21922-552
	SafariSeven Basket	Black	7354-21922-481	7354-21922-482	7355-21922-481	7355-21922-482
	SafariSeven Hi-Gloss	Black	7354-21922-491	7354-21922-492	7355-21922-491	7355-21922-492
Smith & Wesson M&P 9/40 w/ ITI M3, TLR-1, TLR-1HL, SureFire X200/X300/X300U 4.25" BBL	SafariSeven Plain	Black	7354-2192-411	7354-2192-412	7355-2192-411	7355-2192-412
	SafariSeven Plain	FDE Brown	7354-2192-551	7354-2192-552	7355-2192-551	7355-2192-552
	SafariSeven Basket	Black	7354-2192-481	7354-2192-482	7355-2192-481	7355-2192-482
Smith & Wesson M&P 45C 4" BBL	SafariSeven Plain	Black	7354-919-411	7354-919-412	7355-919-411	7355-919-412
	SafariSeven Plain	FDE Brown	7354-919-551	7354-919-552	7355-919-551	7355-919-552
	SafariSeven Basket	Black	7354-919-481	7354-919-482	7355-919-481	7355-919-482
Walther P99Q 4" BBL	SafariSeven Plain	Black	7354-384-411	7354-384-412	7355-384-411	7355-384-412
	SafariSeven Plain	FDE Brown	7354-384-551	7354-384-552	7355-384-551	7355-384-552
Walther PP9Q 5" BBL	SafariSeven Plain	Black	7354-385-411	7354-385-412	7355-385-411	7355-385-412
	SafariSeven FDE	Brown	7354-385-551	7354-385-552	7355-385-551	7355-385-552

Tactical Holsters

7384/7385 7TS™ ALS® OMV TACTICAL HOLSTERS FOR: PISTOLS



7384



7385 W/QUICK RELEASE

FEATURES

- ▶ ALS® (Automatic Locking System) secures weapon once holstered, simple straight up draw once release is deactivated
- ▶ Open-top design without SLS for quick retrieval of weapon
- ▶ Constructed of SafariSeven™, a proprietary nylon blend that is completely non-abrasive to a firearm's finish
- ▶ Raised stand-off surfaces in interior of holster creates air space around the weapon allowing dirt and moisture to quickly clear any contact with the firearm
- ▶ Very high heat and low cold tolerances structurally sound from 300° F to -50° F
- ▶ Can be submerged in water indefinitely and still maintain shape and function
- ▶ Matte finish designed to decrease reflection and can be maintained with a simple scouring pad
- ▶ Standard double strap leg shroud with mounting holes for optional accessories

A complete list of tactical accessories begins on page 161

Models 7384/7385 Tactical Holsters include installed Hood Guard
 Sample Code with ALS Guard Only:
 7384-83-411-AG
 Sample Code with Hood Guard & ALS Guard:
 7384-83-411-AGH

- ▶ Optimized for MOLLE vest with lower center of gravity
- ▶ Available in SafariSeven™ Plain Black and FDE Brown finishes



ALS Guard – Unlocked



ALS Guard – Locked

Models 7384/7385 may be used in conjunction with the Drop Flex Adapter and can also be used with the QLS Systems. The Drop Flex Adapter allows a user to wear a rig below the hip without shifting weight further down the leg and it will also keep the rig from sliding on belt. It can only be used with the single leg strap. (see page 147)

Description	Sample Part No.
DFA on Single Leg Strap w/ Model 7384	7384-XX-411-MS25
DFA on Single Leg Strap w/ QLS w/ Model 7384	7384-XX-411-MS19-MS27

Model 7385 uses the same part numbers as model 7384.

How to Order
Duty Holsters
Duty Accessories
Tactical Holsters
Tactical Accessories
Duty Belts
QAS
Speed Loaders
Light Systems
Concealment Holsters
Concealment Accessories
Competition
Apparel
Sales Support
Index/Price List

Tactical Holsters

7384/7385 7TS™ ALS® OMV TACTICAL HOLSTERS FOR: PISTOLS (continued)

GUN DESCRIPTION	FINISH*	COLOR	7384		7385 W/QUICK RELEASE	
			RIGHT	LEFT	RIGHT	LEFT
Beretta 92F, 92FS, 92G, 96, 96G 4.9" BBL	SafariSeven Plain	Black	7384-73-411	7384-73-412	7385-73-411	7385-73-412
	SafariSeven Plain	FDE Brown	7384-73-551	7384-73-552	7385-73-551	7385-73-552
Glock 17, 22 4.5" BBL	SafariSeven Plain	Black	7384-83-411	7384-83-412	7385-83-411	7385-83-412
	SafariSeven Plain	FDE Brown	7384-83-551	7384-83-552	7385-83-551	7385-83-552
	SafariSeven Basket	Black	7384-83-481	7384-83-482	7385-83-481	7385-83-482
Glock 17, 22 w/ XC-1 Surefire Light 4.5" BBL	SafariSeven Plain	Black	7384-8322-411	7384-8322-412	7385-8322-411	7385-8322-412
	SafariSeven Plain	FDE Brown	7384-8322-551	7384-8322-552	7385-8322-551	7385-8322-552
	SafariSeven Basket	Black	7384-8322-481	7384-8322-482	7385-8322-481	7385-8322-482
	SafariSeven Hi-Gloss	Black	7384-8322-491	7384-8322-492	7385-8322-491	7385-8322-492
Glock 17, 22 w/ ITI M3, TLR-1, TLR-1HL, SureFire X200/X300/X300U 4.5" BBL	SafariSeven Plain	Black	7384-832-411	7354-832-412	7385-832-411	7355-832-412
	SafariSeven Plain	FDE Brown	7384-832-551	7354-832-552	7385-832-551	7355-832-552
	SafariSeven Basket	Black	7384-832-481	7384-832-482	7385-832-481	7355-832-482
	SafariSeven Hi-Gloss	Black	7384-832-491	7384-832-492	7385-832-491	7385-832-492
Glock 19, 23 4.5" BBL	SafariSeven Plain	Black	7384-283-411	7384-283-412	7385-283-411	7385-283-412
	SafariSeven Plain	FDE Brown	7384-283-551	7384-283-552	7385-283-551	7385-283-552
	SafariSeven Basket	Black	7384-283-481	7384-283-482	7385-283-481	7385-283-482
Glock 19, 23 w/ ITI M3, TLR-1, TLR-1HL, SureFire X200/X300/X300U 4" BBL	SafariSeven Plain	Black	7384-2832-411	7384-2832-412	7385-2832-411	7385-2832-412
	SafariSeven Plain	FDE Brown	7384-2832-551	7384-2832-552	7385-2832-551	7385-2832-552
	SafariSeven Basket	Black	7384-2832-481	7384-2832-482	7385-2832-481	7385-2832-482
	SafariSeven Hi-Gloss	Black	7384-2832-491	7384-2832-492	7385-2832-491	7385-2832-492
Glock 19, 23 w/ XC-1 Surefire Light 4" BBL	SafariSeven Plain	Black	7384-28322-411	7384-28322-412	7385-28322-411	7385-28322-412
	SafariSeven Plain	FDE Brown	7384-28322-551	7384-28322-552	7385-28322-551	7385-28322-552
	SafariSeven Basket	Black	7384-28322-481	7384-28322-482	7385-28322-481	7385-28322-482
	SafariSeven Hi-Gloss	Black	7384-28322-491	7384-28322-492	7385-28322-491	7385-28322-492
Glock 20, 21 4.6" BBL	SafariSeven Plain	Black	7384-383-411	7384-383-412	7385-383-411	7385-383-412
	SafariSeven Plain	FDE Brown	7384-383-551	7384-383-552	7385-383-551	7385-383-552
	SafariSeven Basket	Black	7384-383-481	7384-383-482	7385-383-481	7385-383-482
	SafariSeven Hi-Gloss	Black	7384-383-491	7384-383-492	7385-383-491	7385-383-492
Glock 20, 21 w/ ITI M3, TLR-1, TLR-1HL, SureFire X200/X300/X300U 4.5" BBL	SafariSeven Plain	Black	7384-3832-411	7384-3832-412	7385-3832-411	7385-3832-412
	SafariSeven Plain	FDE Brown	7384-3832-551	7384-3832-552	7385-3832-551	7385-3832-552
	SafariSeven Basket	Black	7384-3832-481	7384-3832-482	7385-3832-481	7385-3832-482
	SafariSeven Hi-Gloss	Black	7384-3832-491	7384-3832-492	7385-3832-491	7385-3832-492
Glock 26, 27 4.5" BBL	SafariSeven Plain	Black	7384-183-411	7384-183-412	7385-183-411	7385-183-412
	SafariSeven Plain	FDE Brown	7384-183-551	7384-183-552	7385-183-551	7385-183-552
Heckler & Koch P30 3.78" BBL	SafariSeven Plain	Black	7384-295-411	7384-295-412	7385-295-411	7385-295-412
	SafariSeven Plain	FDE Brown	7384-295-551	7384-295-552	7385-295-551	7385-295-552
Heckler & Koch P2000 DAO 3.5" BBL	SafariSeven Plain	Black	7384-197-411	7384-197-412	7385-197-411	7385-197-412
	SafariSeven Plain	FDE Brown	7384-197-551	7384-197-552	7385-197-551	7385-197-552
Heckler & Koch P2000 DA/SA 3.5" BBL	SafariSeven Plain	Black	7384-397-411	7384-397-412	7385-397-411	7385-397-412
	SafariSeven Plain	FDE Brown	7384-397-551	7384-397-552	7385-397-551	7385-397-552
Heckler & Koch USP 9C/40C DAO 4.25" BBL	SafariSeven Plain	Black	7384-291-411	7384-291-412	7385-291-411	7385-291-412
	SafariSeven Plain	FDE Brown	7384-291-551	7384-291-552	7385-291-551	7385-291-552
Heckler & Koch USP 9C/40C DA/SA 4.25" BBL	SafariSeven Plain	Black	7384-391-411	7384-391-412	7385-391-411	7385-391-412
	SafariSeven Plain	FDE Brown	7384-391-551	7384-391-552	7385-391-551	7385-391-552
Heckler & Koch VP9 4.09" BBL	SafariSeven Plain	Black	7384-593-411	7384-593-412	7385-593-411	7385-593-412
	SafariSeven Plain	FDE Brown	7384-593-551	7384-593-552	7385-593-551	7385-593-552
Ruger American 9mm, .40 4.5" BBL	SafariSeven Plain	Black	7384-167-411	7384-167-412	7385-167-411	7385-167-412
	SafariSeven Plain	FDE Brown	7384-167-551	7384-167-552	7385-167-551	7385-167-552
Ruger .45 ASP 4.5" BBL	SafariSeven Plain	Black	7384-168-411	7384-168-412	7385-168-411	7385-168-412
	SafariSeven Plain	FDE Brown	7384-168-551	7384-168-552	7385-168-551	7385-168-552
Sig Sauer P220, P220R w/ITI M3, TLR-1, TLR-1HL, Surefire X200, X300, X300U 4.41" BBL	SafariSeven Plain	Black	7384-7702-411	7384-7702-412	7385-7702-411	7385-7702-412
	SafariSeven Plain	FDE Brown	7384-7702-551	7384-7702-552	7385-7702-551	7385-7702-552
	SafariSeven Basket	Black	7384-7702-481	7384-7702-482	7385-7702-481	7385-7702-482
	SafariSeven Hi-Gloss	Black	7384-7702-491	7384-7702-492	7385-7702-491	7385-7702-492

Tactical Holsters

7384/7385 7TS™ ALS® OMV TACTICAL HOLSTERS FOR: PISTOLS (continued)

GUN DESCRIPTION	FINISH*	COLOR	7384		7385 W/QUICK RELEASE	
			RIGHT	LEFT	RIGHT	LEFT
Sig Sauer P226, P226R, P226R MK 9mm, .40 w/ITI M3, TLR-1, TLR-1HL, Surefire X200, X300, X300U 4.41" BBL	SafariSeven Plain	Black	7384-4772-411	7384-4772-412	7385-4772-411	7385-4772-412
	SafariSeven Plain	FDE Brown	7384-4772-551	7384-4772-552	7385-4772-551	7385-4772-552
	SafariSeven Basket	Black	7384-4772-481	7384-4772-482	7385-4772-481	7385-4772-482
	SafariSeven Hi-Gloss	Black	7384-4772-491	7384-4772-492	7385-4772-491	7385-4772-492
Sig Sauer P227, P227 R3 w/ITI M3, TLR-1, TLR-1HL, Surefire X200, X300, X300U 3.9" BBL	SafariSeven Plain	Black	7384-6772-411	7384-6772-412	7385-6772-411	7385-6772-412
	SafariSeven Plain	FDE Brown	7384-6772-551	7384-6772-552	7385-6772-551	7385-6772-552
	SafariSeven Basket	Black	7384-6772-481	7384-6772-482	7385-6772-481	7385-6772-482
	SafariSeven Hi-Gloss	Black	7384-6772-491	7384-6772-492	7385-6772-491	7385-6772-492
Sig Sauer P229R DAK, P229R E2 9mm, 3.9" BBL	SafariSeven Plain	Black	7384-474-411	7384-474-412	7385-474-411	7385-474-412
	SafariSeven Plain	FDE Brown	7384-474-551	7384-474-552	7385-474-551	7385-474-552
Sig Sauer P229, P229DAK, P229R 9mm w/ITI M3, TLR-1, TLR-1HL, Surefire X200, X300, X300U 3.9" BBL	SafariSeven Plain	Black	7384-4742-411	7384-4742-412	7385-4742-411	7385-4742-412
	SafariSeven Plain	FDE Brown	7384-4742-551	7384-4742-552	7385-4742-551	7385-4742-552
	SafariSeven Basket	Black	7384-4742-481	7384-4742-482	7385-4742-481	7385-4742-482
	SafariSeven Hi-Gloss	Black	7384-4742-491	7384-4742-492	7385-4742-491	7385-4742-492
Sig Sauer P229, P229R, .40 3.9" BBL	SafariSeven Plain	Black	7384-447-411	7384-447-412	7385-447-411	7385-447-412
	SafariSeven Plain	FDE Brown	7384-447-551	7384-447-552	7385-447-551	7385-447-552
Sig Sauer P229, P229R .40 w/ITI M3, TLR-1, TLR-1HL, Surefire X200, X300, X300U 3.9" BBL	SafariSeven Plain	Black	7384-4472-411	7384-4472-412	7385-4472-411	7385-4472-412
	SafariSeven Plain	FDE Brown	7384-4472-551	7384-4472-552	7385-4472-551	7385-4472-552
	SafariSeven Basket	Black	7384-4472-481	7384-4472-482	7385-4472-481	7385-4472-482
	SafariSeven Hi-Gloss	Black	7384-4472-491	7384-4472-492	7385-4472-491	7385-4472-492
Sig Sauer P220, P226, P220R, P226R, P226R MK25 9mm, .40 4.41" BBL P227 R3 .45 3.9" BBL	SafariSeven Plain	Black	7384-477-411	7384-477-412	7385-477-411	7385-477-412
	SafariSeven Plain	FDE Brown	7384-477-551	7384-477-552	7385-477-551	7385-477-552
Sig Sauer P320 Full Size 9mm, .40 4.7" BBL	SafariSeven Plain	Black	7384-450-411	7384-450-412	7385-450-411	7385-450-412
	SafariSeven Plain	FDE Brown	7384-450-551	7384-450-552	7385-450-551	7385-450-552
Sig Sauer P320 Full Size 9mm, .40 w/ ITI M3, TLR-1, TLR-1HL Surefire X200/X300/X300U 4.7" BBL	SafariSeven Plain	Black	7384-4502-411	7384-4502-412	7385-4502-411	7385-4502-412
	SafariSeven Plain	FDE Brown	7384-4502-551	7384-4502-552	7385-4502-551	7385-4502-552
	SafariSeven Basket	Black	7384-4502-481	7384-4502-482	7385-4502-481	7385-4502-482
	SafariSeven Hi-Gloss	Black	7384-4502-491	7384-4502-492	7385-4502-491	7385-4502-492
Sig Sauer P320 Compact & Carry 9mm, .40 3.9" BBL	SafariSeven Plain	Black	7384-750-411	7384-750-412	7385-750-411	7385-750-412
	SafariSeven Plain	FDE Brown	7384-750-551	7384-750-552	7385-750-551	7385-750-552
Sig Sauer P320 Compact & Carry 9mm, .40 w/ ITI M3, TLR-1, TLR-1HL Surefire X200/X300/X300U 4.7" BBL	SafariSeven Plain	Black	7384-7502-411	7384-7502-412	7385-7502-411	7385-7502-412
	SafariSeven Plain	FDE Brown	7384-7502-551	7384-7502-552	7385-7502-551	7385-7502-552
	SafariSeven Basket	Black	7384-7502-481	7384-7502-482	7385-7502-481	7385-7502-482
	SafariSeven Hi-Gloss	Black	7384-7502-491	7384-7502-492	7385-7502-491	7385-7502-492
Sig Sauer P320 Full Size .45 3.9" BBL	SafariSeven Plain	Black	7384-451-411	7384-451-412	7385-451-411	7385-451-412
	SafariSeven Plain	FDE Brown	7384-451-551	7384-451-552	7385-451-551	7385-451-552
Sig Sauer P320 Full Size .45 w/ ITI M3, TLR-1, TLR-1HL Surefire X200/X300/X300U 3.9" BBL	SafariSeven Plain	Black	7384-4512-411	7384-4512-412	7385-4512-411	7385-4512-412
	SafariSeven Plain	FDE Brown	7384-4512-551	7384-4512-552	7385-4512-551	7385-4512-552
	SafariSeven Basket	Black	7384-4512-481	7384-4512-482	7385-4512-481	7385-4512-482
	SafariSeven Hi-Gloss	Black	7384-4512-491	7384-4512-492	7385-4512-491	7385-4512-492
Sig Sauer P320 Compact & Carry .45 3.9" BBL	SafariSeven Plain	Black	7384-751-411	7384-751-412	7385-751-411	7385-751-412
	SafariSeven Plain	FDE Brown	7384-751-551	7384-751-552	7385-751-551	7385-751-552
Sig Sauer P320 Compact & Carry .45 w/ ITI M3, TLR-1, TLR-1HL Surefire X200/X300/X300U 3.9" BBL	SafariSeven Plain	Black	7384-7512-411	7384-7512-412	7385-7512-411	7385-7512-412
	SafariSeven Plain	FDE Brown	7384-7512-551	7384-7512-552	7385-7512-551	7385-7512-552
	SafariSeven Basket	Black	7384-7512-481	7384-7512-482	7385-7512-481	7385-7512-482
	SafariSeven Hi-Gloss	Black	7384-7512-491	7384-7512-492	7385-7512-491	7385-7512-492

How to Order
Duty Holsters
Duty Accessories
Tactical Holsters
Tactical Accessories
Duty Bats
QAS
Speed Loaders
Light Systems
Concealment Holsters
Concealment Accessories
Competition
Apparel
Sales Support
Index/Price List

Tactical Holsters

7384/7385 7TS™ ALS® OMV TACTICAL HOLSTERS FOR: PISTOLS (continued)

GUN DESCRIPTION	FINISH*	COLOR	7384		7385 W/QUICK RELEASE	
			RIGHT	LEFT	RIGHT	LEFT
Smith & Wesson M&P 45 4.5" BBL	SafariSeven Plain	Black	7384-419-411	7384-419-412	7385-419-411	7385-419-412
	SafariSeven Plain	FDE Brown	7384-419-551	7384-419-552	7385-419-551	7385-419-552
	SafariSeven Basket	Black	7384-419-481	7384-419-482	7385-419-481	7385-419-482
Smith & Wesson M&P .45 w/ITI M3, TLR-1, TLR-1HL, Surefire X200, X300, X300U 3.9" BBL	SafariSeven Plain	Black	7384-4192-411	7384-4192-412	7385-4192-411	7385-4192-412
	SafariSeven Plain	FDE Brown	7384-4192-551	7384-4192-552	7385-4192-551	7385-4192-552
	SafariSeven Basket	Black	7384-4192-481	7384-4192-482	7385-4192-481	7385-4192-482
Smith & Wesson M&P 9L, .40L 5" BBL	SafariSeven Plain	Black	7384-819-411	7384-819-412	7385-819-411	7385-819-412
	SafariSeven Plain	FDE Brown	7384-819-551	7384-819-552	7385-819-551	7385-819-552
Smith & Wesson M&P 9L, .40L w/ITI M3, TLR-1, TLR-1HL, Surefire X200, X300, X300U 5" BBL	SafariSeven Plain	Black	7384-8192-411	7384-8192-412	7385-8192-411	7385-8192-412
	SafariSeven Plain	FDE Brown	7384-8192-551	7384-8192-552	7385-8192-551	7385-8192-552
	SafariSeven Basket	Black	7384-8192-481	7384-8192-482	7385-8192-481	7385-8192-482
Smith & Wesson M&P 9mm, .40 4.25" BBL	SafariSeven Plain	Black	7384-219-411	7384-219-412	7385-219-411	7385-219-412
	SafariSeven Plain	FDE Brown	7384-219-551	7384-219-552	7385-219-551	7385-219-552
Smith & Wesson M&P 9mm, .40 5" BBL	SafariSeven Plain	Black	7384-819-411	7384-819-412	7385-819-411	7385-819-412
	SafariSeven Plain	FDE Brown	7384-819-551	7384-819-552	7385-819-551	7385-819-552
Smith & Wesson M&P 9mm, .40 w/ XC-1 Surefire Light 4.25" BBL	SafariSeven Plain	Black	7384-21922-411	7384-21922-412	7385-21922-411	7385-21922-412
	SafariSeven Plain	FDE Brown	7384-21922-551	7384-21922-552	7385-21922-551	7385-21922-552
	SafariSeven Basket	Black	7384-21922-481	7384-21922-482	7385-21922-481	7385-21922-482
Smith & Wesson M&P 9/40 w/ ITI M3, TLR-1, TLR-1HL SureFire X200/X300/X300U 4.25" BBL	SafariSeven Plain	Black	7384-2192-411	7384-2192-412	7385-2192-411	7385-2192-412
	SafariSeven Plain	FDE Brown	7384-2192-551	7384-2192-552	7385-2192-551	7385-2192-552
	SafariSeven Basket	Black	7384-2192-481	7384-2192-482	7385-2192-481	7385-2192-482
Smith & Wesson M&P 45C 4" BBL	SafariSeven Plain	Black	7384-919-411	7384-919-412	7385-919-411	7385-919-412
	SafariSeven Plain	FDE Brown	7384-919-551	7384-919-552	7385-919-551	7385-919-552
	SafariSeven Basket	Black	7384-919-481	7384-919-482	7385-919-481	7385-919-482
Walther P99Q 4" BBL	SafariSeven Plain	Black	7384-384-411	7384-384-412	7385-384-411	7385-384-412
	SafariSeven Plain	FDE Brown	7384-384-551	7384-384-552	7385-384-551	7385-384-552
Walther PP9Q 5" BBL	SafariSeven Plain	Black	7384-385-411	7384-385-412	7385-385-411	7385-385-412
	SafariSeven FDE	Brown	7384-385-551	7384-385-552	7385-385-551	7385-385-552

Tactical Accessories

35 BATON HOLDER

DESCRIPTION	PART NO.
Expandable Baton Holder – Fits 21" batons	35-F21-23
Expandable Baton Holder – Fits 26" batons	35-F26-23



* See additional color listings at bottom of page

37 OPEN TOP MACE®/OC SPRAY HOLDER

DESCRIPTION	PART NO.
Direct Impact® Pouch – OC 40mm/eXact iImpact™ 1006 40mm	37-8-23



* See additional color listings at bottom of page and additional fit listings on pg. 71

38 OC SPRAY HOLDER

DESCRIPTION	PART NO.
OC Spray Pouch – 1.375" x 4"	38-2-23PBL
OC Spray Pouch – 1.375" x 5"	38-3-23PBL
OC Spray Pouch – 1.5" x 4"-4.5"	38-4-23PBL
OC Spray Pouch – MK-9 – 2.38" x 8.5"	38-6-23PBL
OC Spray Pouch – Capstrum Z-305	38-5-23PBL
Direct Impact® Pouch – OC 40mm/eXact iImpact™ 1006 40mm	38-8-23PBL
OC Spray Pouch – 1.5" x 5.5"-6.5"	38-23PBL



* See additional color listings at bottom of page

* All Tactical pouches available in these additional colors.

Sample Codes w/ Snap		Sample Codes w/o Snap	
Foliage Green	76-53-543PBL	Foliage Green	37-8-543
Coyote Brown	76-53-763PBL	Coyote Brown	37-8-763
OD Green	76-53-563PBL	OD Green	37-8-563
FDE Brown	76-53-553PBL	FDE Brown	37-8-553

How to Order
Duty Holsters
Duty Accessories
Tactical Holsters
Tactical Accessories
Duty Belts
OAS
Speed Loaders
Light Systems
Concealment Holsters
Concealment Accessories
Competition
Apparel
Sales Support
Index/Price List

Tactical Accessories

40 DISTRACTION DEVICE® HOLDER



DESCRIPTION	PART NO.
Distraction Device® Holder Complete for Defense Technology® #25	40-1-23PBL
Distraction Device® Holder to fit DT Omni Blast 100	40-2-23PBL
Distraction Device® Holder Niko	40-3-23PBL
Defense Technology® Low Roll™	40-4-23PBL
Defense Technology® Low Roll II™	40-5-23PBL

* See additional color listings at bottom of page

Dimensions:
 40-1: 1.875" Wide x 5.5" High
 40-2: 1.375" Wide x 5" High
 40-3: 1.5" Wide x 4.5" High
 40-4: 2" Wide x 5.75" High
 40-5: 1.75" Wide x 5.5" High

76 SINGLE MAGAZINE POUCH



DESCRIPTION	PART NO.
Single Mag Pouch, Handguns – 1911	76-53-23PBL
Single Mag Pouch, Handguns – 5906, 226, 92F	76-76-23PBL
Single Mag Pouch, Handguns – Glock 17, 19, 22, 23	76-83-23PBL
Single Mag Pouch, Handguns – S&W 1006, 4506-1	76-210-23PBL
Single Mag Pouch, Handguns – Glock 20, 21	76-383-23PBL

* See additional color listings at bottom of page and additional fit listings on pg. 92

* All Tactical pouches available in these additional colors.

*Sample Codes w/ Snap		Sample Codes w/o Snap	
Foliage Green	76-53-543PBL	Foliage Green	37-8-543
Coyote Brown	76-53-763PBL	Coyote Brown	37-8-763
OD Green	76-53-563PBL	OD Green	37-8-563
FDE Brown	76-53-553PBL	FDE Brown	37-8-553

Tactical Accessories

77 DOUBLE MAGAZINE POUCH

DESCRIPTION	PART NO.
Double Mag Pouch, Handguns – 1911	77-53-23PBL
Double Mag Pouch, Handguns – 5906, 226, 92F	77-76-23PBL
Double Mag Pouch, Handguns – Glock 17, 19, 22, 23	77-83-23PBL
Double Mag Pouch, Handguns – H&K MK23	77-94-23PBL
Double Mag Pouch, Handguns – P225, 239	77-118-23PBL
Double Mag Pouch, Handguns – S&W 1006, 4506-1	77-210-23PBL
Double Mag Pouch, Handguns – Glock 20, 21	77-383-23PBL

*See additional color listings at the bottom of page.



78 SLIMLINE DOUBLE MAGAZINE POUCH

DESCRIPTION	PART NO.
Slimline Double Magazine Pouch, Handguns – 1911	78-53-23PBL
Slimline Double Magazine Pouch, Handguns – Beretta 92F, Sig Sauer P226	78-76-23PBL
Slimline Double Magazine Pouch, Handguns – Glock 17, 22, 34	78-83-23PBL
Slimline Double Magazine Pouch, Handguns – Glock 20, 21	78-383-23PBL
Slimline Double Magazine Pouch, Handguns – S&W M&P 45C	78-119-23PBL

*See additional color listings at the bottom of page.



* All Tactical pouches available in these additional colors.

*Sample Codes w/ Snap		*Sample Codes w/o Snap	
Foliage Green	76-53-543PBL	Foliage Green	37-8-543
Coyote Brown	76-53-763PBL	Coyote Brown	37-8-763
OD Green	76-53-563PBL	OD Green	37-8-563
FDE Brown	76-53-553PBL	FDE Brown	37-8-553

How to Order
Duty Holsters
Duty Accessories
Tactical Holsters
Tactical Accessories
Duty Belts
QAS
Speed Loaders
Light Systems
Concealment Holsters
Concealment Accessories
Competition
Apparel
Sales Support
Index/Price List

Tactical Accessories

79 OPEN TOP SLIMLINE DOUBLE MAGAZINE POUCH



DESCRIPTION	PART NO.
Slimline Open Top Double Magazine Pouch, Handguns – 1911	79-53-23
Slimline Open Top Double Magazine Pouch, Handguns – Beretta 92F, Sig Sauer P226	79-76-23
Slimline Open Top Double Magazine Pouch, Handguns – Glock 17, 22, 34	79-83-23
Slimline Open Top Double Magazine Pouch, Handguns – Glock 20, 21	79-383-23

*See additional color listings at the bottom of page.

775 OPEN TOP SLIMLINE TRIPLE MAGAZINE POUCH



DESCRIPTION	PART NO.
Slimline Open Top Triple Magazine Pouch, Handguns – 1911	775-53-23
Slimline Open Top Triple Magazine Pouch, Handguns – Beretta 92F, Sig Sauer P226	775-76-23
Slimline Open Top Triple Magazine Pouch, Handguns – Glock 17, 22, 34	775-83-23
Slimline Open Top Triple Magazine Pouch, Handguns – Glock 20, 21	775-383-23
Slimline Open Top Triple Magazine Pouch, Handguns – S&W M&P .45	775-419-23

*See additional color listings at the bottom of page.

777 SLIMLINE TRIPLE MAGAZINE POUCH



DESCRIPTION	PART NO.
Slimline Triple Magazine Pouch, Handguns – 1911	777-53-23PBL
Slimline Triple Magazine Pouch, Handguns – Beretta 92F, Sig Sauer P226	777-76-23PBL
Slimline Triple Magazine Pouch, Handguns – Glock 17, 22, 34	777-83-23PBL
Slimline Triple Magazine Pouch, Handguns – Glock 20, 21	777-383-23PBL

*See additional color listings at the bottom of page.

190 SINGLE HANDCUFF CASE



DESCRIPTION	PART NO.
Single Handcuff Case	190-23PBL

* See additional color listings at bottom of page

* All Tactical pouches available in these additional colors

Sample Codes w/ Snap	Sample Codes w/o Snap
Foliage Green 76-53-543PBL	Foliage Green 37-8-543
Coyote Brown 76-53-763PBL	Coyote Brown 37-8-763
OD Green 76-53-563PBL	OD Green 37-8-563
FDE Brown 76-53-553PBL	FDE Brown 37-8-553

Tactical Accessories

307 EDW CARTRIDGE HOLDER

- ▶ For attachment to leg shrouds

DESCRIPTION	PART NO.
Taser® Cartridge	307-9-23PBL

* See additional color listings on page 161.



308 HAND-HELD FLASHLIGHT HOLDER

- ▶ Model 308 fits INOVA T3 flashlight

DESCRIPTION	COLOR	PART NO.
STX Plain	Black	308-4-413PBL*
STX Hi Gloss	Black	308-4-493PBL*
STX Tactical	Black	308-4-13PBL*
STX Basket	Black	308-4-483PBL*

* See additional color listings on page 161.



774 RIFLE MAGAZINE POUCH

DESCRIPTION	PART NO.
Rifle Mag Pouch, H&K G36	774-212-23
Rifle Mag Pouch, Colt AR15	774-215-23
Rifle Mag Pouch, H&K MP5	774-216-23
Rifle Mag Pouch, Springfield M1A	774-308-23
Rifle Mag Pouch, SPC 6.8	774-213-23



TMA TACTICAL MOLLE ADAPTER

- ▶ For use with Safariland 3-hole patterned holster
- ▶ Easily adjusts with multi-tool
- ▶ Full 360 degree cant
- ▶ Available in Black

DESCRIPTION	COLOR	PART NO.
Tactical MOLLE Adapter	Black	TMA-1-2
Tactical MOLLE Adapter w/ MLS 16	Black	TMA-1-2-MS16



MPA MOUNTING PATTERN ADAPTOR

- ▶ For use with alternative mounting hole patterns
- ▶ Adjustable cant
- ▶ Available in Black

DESCRIPTION	COLOR	PART NO.
Mounting Pattern Adaptor	Black	MPA-1-2



How to Order
Duty Holsters
Duty Accessories
Tactical Holsters
Tactical Accessories
Duty Belts
QAS
Speed Loaders
Light Systems
Concealment Holsters
Concealment Accessories
Competition
Apparel
Sales Support
Index/Price List

Tactical Accessories

4332 TACTICAL ELS BELT, 2" (50mm)



Ballistic Nylon Duty Belt with pre-cut holes to mount ELS 35 Receiver Plates in multiple locations and angles. ELS 35 Receiver Plates sold separately

- ▶ Features full length hook lining for use with Bianchi® 8106 Liner Belt
- ▶ Buckleless design features two large knobs for locking in ELS mounting holes
- ▶ Pre-cut ELS mounting holes for straight up or angled attachment of ELS Receiver Plates
- ▶ Available in Nylon Look, Coyote Brown, FDE Brown, and Foliage Green finishes

DESCRIPTION	COLOR	PART NO.
Plain	OD Green	4332-XX-56
Plain	Coyote Brown	4332-XX-76
Plain	Foliage Green	4332-XX-54
Plain	FDE Brown	4332-XX-55
Basketweave	Black	4332-XX-4
Nylon Look	Black	4332-XX-26

*Model 4332 is available in even sizes from 24" (61cm) to 44" (112cm). Sizes 46" (117cm) and above are available at additional cost (call for pricing). To order any belt, simply replace the X in the part number with the proper size, i.e. 4332-34-4. Before measuring for any belt, please read "Ordering a Belt" in the "How to Order" section.

How to Order
Duty Holsters
Duty Accessories
Tactical Holsters
Tactical/Accessories
Duty Belts
OAS
Speed Loaders
Light Systems
Concealment Holsters
Concealment Accessories
Competition
Apparel
Sales Support
Index/Price List

Tactical Accessories

4552 DUAL RIFLE CASE

- ▶ Rugged ballistic pack cloth construction
- ▶ Heavy-duty lockable zippers, one adjustable outside covered accessory pouch
- ▶ Large dual handgun/accessory pouch with individual hook and loop enclosed handgun areas
- ▶ Closed-cell protective foam padding and 2" perimeter lip
- ▶ Assorted accessory pockets inside case
- ▶ Adjustable padded shoulder harness for shoulder carry
- ▶ Includes adjustable backpack-style carry straps that tuck away in storage pocket when not in use

DESCRIPTION	COLOR	PART NO.
36" Rifle Case	Black	4552-36-4
36" Rifle Case	Tan	4552-36-55
DIMENSIONS – Inside: L 36" x H 11" x W 3" Outside: L 38" x H 12" W 6"		
46" Rifle Case	Black	4552-46-4
46" Rifle Case	Tan	4552-46-55
DIMENSIONS – Inside: L 46" x H 12" x W 3" Outside: L 48" x H 13" W 6"		



Safariland® offers a wide variety of separately sold accessories which can be used with the MOLLE loops on the front of the bag.

How to Order
Duty Holsters
Duty Accessories
Tactical Holsters
Tactical Accessories
Duty Belts
QAS
Speed Loaders
Light Systems
Concealment Holsters
Concealment Accessories
Competition
Apparel
Sales Support
Index/Price List

Tactical Accessories

6004-6 DOUBLE STRAP LEG SHROUD



Shown w/ accessories attached

- ▶ This is the Standard Leg Shroud used on Safariland 6004 Tactical Holsters
- ▶ Features harness and shroud only to mount accessories
- ▶ Ambidextrous

DESCRIPTION	COLOR	PART NO.
Double Strap Leg Shroud-Complete Assembly	Black	6004-6-123
	Foliage Green	6004-6-543
	Coyote Brown	6004-6-763
	OD Green	6004-6-563
	FDE Brown	6004-6-553

Sample Part No. w/ QLS 22
6004-6-2-MS22

6004-10 SINGLE STRAP LEG SHROUD



- ▶ Lower profile leg shroud designed primarily for EDW units
- ▶ Can mount accessories on both sides of holster, or used for 3 accessories
- ▶ Adjustable vertical leg strap to adjust ride height

DESCRIPTION	COLOR	PART NO.
Single Strap Leg Shroud-Complete Assembly	Black	6004-10-2
	Foliage Green	6004-10-54
	Coyote Brown	6004-10-76
	OD Green	6004-10-56
	FDE Brown	6004-10-55

Sample Part No. w/ holster: 6004-832-121-SP10
Sample Part No. on Holster w/ QLS 19 & QLS 22: 6004-83-121-SP10-MS30

Sample Part No. w/ QLS 22 Only: 6004-10-76-MS22

Tactical Accessories

6004-110 LIGHTWEIGHT LEG SHROUD

DESCRIPTION	COLOR	PART NO.
Lightweight Leg Shroud-Complete Assembly	Black	6004-110-2
	Foliage Green	6004-110-54
	Coyote Brown	6004-110-76
	OD Green	6004-110-56
	FDE Brown	6004-110-55

Sample Part No. on Holster: 6004-83-121-LP	Sample Part No. w/ QLS 22 Only 6004-110-76-MS22
Sample Part No. on Holster w/ QLS 19 & QLS 22 6004-83-121-LP-MS30	



6004DFA DROP FLEX ADAPTER

- ▶ Allows user to wear a thigh rig below the hip without shifting weight farther down the leg
- ▶ Keeps rig from sliding on belt
- ▶ Can be used on belt widths up to 2.25" (58mm)
- ▶ For use in conjunction with the 6004-10 leg shroud

DESCRIPTION	COLOR	PART NO.
Drop Flex Adapter Only	Black	6004DFA-2
	Foliage Green	6004DFA-54
	Coyote Brown	6004DFA-76
	OD Green	6004DFA-56
	FDE Brown	6004DFA-55
Drop Flex Adapter on Single Strap Leg Shroud	Black	6004-25-2
	Foliage Green	6004-25-54
	Coyote Brown	6004-25-76
	OD Green	6004-25-56
	FDE Brown	6004-25-55
Drop Flex Adapter on Single Strap Leg Shroud w/ QLS 22	Black	6004-27-2
	Foliage Green	6004-27-54
	Coyote Brown	6004-27-76
	OD Green	6004-27-56
	FDE Brown	6004-27-55



Sample Part No. w/ DFA Only
6004-83-121-MS25
Sample Part No. w/ QLS 19 & QLS 22
6004-83-121-MS19-MS27

How to Order
Duty Holsters
Duty Accessories
Tactical Holsters
Tactical Accessories
Duty Belts
QAS
Speed Loaders
Light Systems
Concealment Holsters
Concealment Accessories
Competition
Apparel
Sales Support
Index/Price List

Tactical Accessories

6004UFA UNIVERSAL FLEX ADAPTER



- ▶ Allows user to wear a thigh rig below the hip without shifting weight further down the leg
- ▶ Hole pattern on UFA makes connectig to various mounts possible including paddle, ELS fork, QLS for or 744BL Belt Clip
- ▶ For use in conjunction with 6004-10 leg shroud

DESCRIPTION	COLOR	PART NO.
Universal Flex Adapter Only	Black	6004UFA-2
	Foliage Green	6004UFA-54
	Coyote Brown	6004UFA-76
	OD Green	6004UFA-56
	FDE Brown	6004UFA-55

PART NO.	DESCRIPTION
----------	-------------

UFA w/Mounting Platform

6004UFA-1-2	6004UFA & QLS 19
6004UFA-2-2	6004UFA & ELS 34
6004UFA-3-2	6004UFA and a MLS 16
6004UFA-4-2	6004UFA and a 745BL
6004UFA-5-2	6004UFA and a 567BL (1.5"/1.75")
6004UFA-6-21	6004UFA and a 568BL, RH
6004UFA-6-22	6004UFA and a 568BL, LH
6004UFA-8-2	6004UFA & Strap Webbing

UFA on Single Strap Leg Shroud w/Mounting Platform

6004UFA-SP1-2	6004UFA & QLS 19 on Single Strap Leg Shroud
6004UFA-SP2-2	6004UFA & ELS 34 on Single Strap Leg Shroud
6004UFA-SP3-2	6004UFA and a MLS 16 on Single Strap Leg Shroud
6004UFA-SP4-2	6004UFA and a 745BL on Single Strap Leg Shroud
6004UFA-SP5-2	6004UFA and a 567BL (1.5" / 1.75") on Single Strap Leg Shroud
6004UFA-SP6-21	6004UFA and a 568BL on Single Strap Leg Shroud
6004UFA-SP6-22	6004UFA and a 568BL on Single Strap Leg Shroud
6004UFA-SP8-2	6004UFA & Strap Webbing on 6004-10

UFA on Single Strap Leg Shroud w/Mounting Platform and QLS 22

6004UFA-SP1-2-MS22	6004UFA & QLS 19 on Single Strap Leg Shroud with QLS 22 Receiver Plate
6004UFA-SP2-2-MS22	6004UFA & ELS 34 on Single Strap Leg Shroud with QLS 22 Receiver Plate
6004UFA-SP3-2-MS22	6004UFA and a MLS 16 on Single Strap Leg Shroud with QLS 22 Receiver Plate
6004UFA-SP4-2-MS22	6004UFA and a 745BL on Single Strap Leg Shroud with QLS 22 Receiver Plate
6004UFA-SP5-2-MS22	6004UFA and a 567BL (1.5"/1.75") on Single Strap Leg Shroud with QLS 22 Receiver Plate
6004UFA-SP6-21/22-MS22	6004UFA and a 568BL on Single Strap Leg Shroud with QLS 22 Receiver Plate
6004UFA-SP8-2-MS22	6004UFA & Strap Webbing on Single Strap Leg Shroud with QLS 22 Receiver Plate

UFA on Lightweight Leg Shroud w/Mounting Platform

6004UFA-LP1-2	6004UFA & QLS 19 on Lightweight Leg Shroud
6004UFA-LP2-2	6004UFA & ELS 34 on Lightweight Leg Shroud
6004UFA-LP3-2	6004UFA and a MLS 16 on Lightweight Leg Shroud
6004UFA-LP4-2	6004UFA and a 745BL on Lightweight Leg Shroud
6004UFA-LP5-2	6004UFA and a 567BL (1.5"/1.75") on Lightweight Leg Shroud
6004UFA-LP6-21/22	6004UFA and a 568BL on Lightweight Leg Shroud
6004UFA-LP8-2	6004UFA & Strap Webbing on 6004-110

UFA on Lightweight Leg Shroud w/Mounting Platform and QLS 22

6004UFA-LP1-2-MS22	6004UFA & QLS 19 on Lightweight Leg Shroud with QLS 22 Receiver Plate
6004UFA-LP2-2-MS22	6004UFA & ELS 34 on Lightweight Leg Shroud with QLS 22 Receiver Plate
6004UFA-LP3-2-MS22	6004UFA and a MLS 16 on Lightweight Leg Shroud with QLS 22 Receiver Plate
6004UFA-LP4-2-MS22	6004UFA and a 745BL on Lightweight Leg Shroud with QLS 22 Receiver Plate
6004UFA-LP5-2-MS22	6004UFA and a 567BL (1.5" / 1.75") on Lightweight Leg Shroud with QLS 22 Receiver Plate
6004UFA-LP6-21/22-MS22	6004UFA and a 568BL on Lightweight Leg Shroud with QLS 22 Receiver Plate
6004UFA-LP8-2-MS22	6004UFA & Strap Webbing on Lightweight Leg Shroud with QLS 22 Receiver Plate

EXAMPLE PART NO.	DESCRIPTION.
------------------	--------------

6004-83-121-SP1	6004UFA & QLS 19 on Single Strap Leg Shroud
6004-83-121-SP2	6004UFA & ELS 34 on Single Strap Leg Shroud
6004-83-121-SP3	6004UFA and a MLS 16 on Single Strap Leg Shroud
6004-83-121-SP4	6004UFA and a 745BL on Single Strap Leg Shroud
6004-83-121-SP5	6004UFA and a 567BL (1.5" / 1.75") on Single Strap Leg Shroud
6004-83-121-SP6	6004UFA and a 568BL on Single Strap Leg Shroud
6004-83-121-SP7	6004UFA & Strap Webbing (Special size of webbing on 6004-10)
6004-83-121-SP8	6004UFA & Strap Webbing (Regular size of webbing)

Tactical Accessories

6004-4 LEG SHROUD ONLY

DESCRIPTION	COLOR	PART NO.
Leg Shroud Only (Straps NOT Included)	Black	6004-4-2
	Foliage Green	6004-4-54
	Coyote Brown	6004-4-76
	OD Green	6004-4-56
	FDE Brown	6004-4-55



6004-14 SINGLE STRAP LEG SHROUD ONLY

DESCRIPTION	COLOR	PART NO.
Single Strap Leg Shroud (Straps NOT Included)	Black	6004-14-2
	Foliage Green	6004-14-54
	Coyote Brown	6004-14-76
	OD Green	6004-14-56
	FDE Brown	6004-14-55



6004-114 LIGHTWEIGHT LEG SHROUD ONLY

DESCRIPTION	COLOR	PART NO.
Lightweight Leg Shroud Only (Strap NOT Included)	Black	6004-114-2
	Foliage Green	6004-114-54
	Coyote Brown	6004-114-76
	OD Green	6004-114-56
	FDE Brown	6004-114-55



6004-11 VERTICAL LEG STRAP ONLY

- ▶ Fits tactical holster systems
- ▶ Replacement strap for standard tactical rigs

DESCRIPTION	COLOR	PART NO.
Vertical Leg Strap Only	Black	6004-11-2
	Foliage Green	6004-11-54
	Coyote Brown	6004-11-76
	OD Green	6004-11-56
	FDE Brown	6004-11-55



6004-8 SMALL MOLLE ADAPTER PLATE 4" X 5"

DESCRIPTION	COLOR	PART NO.
Small MOLLE Adapter Plate	Black	6004-8-2
	Foliage Green	6004-8-54
	Coyote Brown	6004-8-76
	OD Green	6004-8-56
	FDE Brown	6004-8-55



Sample Part No. on Holster:
6004-8-2-MS22

*Available for order with QLS22.

How to Order
Duty Holsters
Duty Accessories
Tactical Holsters
Tactical Accessories
Duty Belts
QAS
Speed Loaders
Light Systems
Concealment Holsters
Concealment Accessories
Competition
Apparel
Sales Support
Index/Price List

Tactical Accessories

6005-6 DOUBLE STRAP LEG SHROUD W/QUICK-RELEASE



- ▶ Features harness and shroud only to mount accessories
- ▶ Ambidextrous

DESCRIPTION	COLOR	PART NO.
Double Strap Leg Shroud w/ Quick-Release Leg Strap-Complete Assembly	Black	6005-6-123
	Foliage Green	6005-6-543
	Coyote Brown	6005-6-763
	OD Green	6005-6-563
	FDE Brown	6005-6-553

Sample Part No. w/ QLS 22 Only
6005-6-123-MS22

6005-10 SINGLE STRAP LEG SHROUD W/QUICK-RELEASE



DESCRIPTION	COLOR	PART NO.
Single Strap Leg Shroud w/ Quick-Release Leg Strap-Complete Assembly	Black	6005-10-2
	Foliage Green	6005-10-54
	Coyote Brown	6005-10-76
	OD Green	6005-10-56
	FDE Brown	6005-10-55

Sample Part No. on holster:
6005-832-121-SP10
Sample Part No. on Holster w/ QLS 19 & QLS 22
6005-83-121-SP10-MS30
Sample Part No. w/ QLS 22 Only
6005-10-76-MS22

6005-110 LIGHTWEIGHT LEG SHROUD W/QUICK-RELEASE



DESCRIPTION	COLOR	PART NO.
Lightweight Leg Shroud w/ Quick-Release Leg Strap-Complete Assembly	Black	6005-110-2
	Foliage Green	6005-110-54
	Coyote Brown	6005-110-76
	OD Green	6005-110-56
	FDE Brown	6005-110-55

Sample Part No. on Holster: 6005-83-121-LP
Sample Part No. on Holster w/ QLS 19 & QLS 22
6005-83-121-LP-MS30

Sample Part No. w/ QLS 22 Only
6005-110-76-MS22

Tactical Accessories

6005-7 BUCKLE PORTION OF QUICK-RELEASE LEG STRAP

DESCRIPTION	COLOR	PART NO.
Top Portion of Removable Harness	Black	6005-7-2
	Foliage Green	6005-7-54
	Coyote Brown	6005-7-76
	OD Green	6005-7-56
	FDE Brown	6009-7-55



6005-11 QUICK-RELEASE LEG STRAP ONLY

- ▶ Replacement strap for Quick Detach tactical rig straps
- ▶ Converts tactical rig straps to Quick Detach straps
- ▶ Top buckle portion can be purchased separately (6005-7)

DESCRIPTION	COLOR	PART NO.
Quick-Release Leg Strap Only	Black	6005-11-2
	Foliage Green	6005-11-54
	Coyote Brown	6005-11-76
	OD Green	6005-11-56
	FDE Brown	6009-11-55



6005-23 MLS ACCESSORY FORK ON QUICK-RELEASE LEG STRAP

DESCRIPTION	COLOR	PART NO.
Quick-Release Top Strap with MLS 16	Black	6005-23-2
	Foliage Green	6005-23-54
	Coyote Brown	6005-23-76
	OD Green	6005-23-56
	FDE Brown	6009-23-55



6005VE QUICK-RELEASE BUCKLE W/ ENHANCED HOOK & LOOP BELT ATTACHMENT

- ▶ Fits Safariland® tactical shrouds
- ▶ Belt attachment portion can be detached from belt when not in use
- ▶ Secondary hook and loop flap ensures continuous attachment to belt when in use

DESCRIPTION	COLOR	PART NO.
Quick-Release Buckle w/Enhanced Hook & Loop Belt Attachment	Black	6005VE-7-2
	Foliage Green	6005VE-7-54
	Coyote Brown	6005VE-7-76
	OD Green	6005VE-7-56
	FDE Brown	6005VE-7-55



6009-6 DOUBLE STRAP LEG SHROUD W/ D-RING

DESCRIPTION	COLOR	PART NO.
Double Strap Leg Shroud w/ D-Ring Complete Assembly	Black	6009-6-123
	Foliage Green	6009-6-543
	Coyote Brown	6009-6-763
	OD Green	6009-6-563
	FDE Brown	6009-6-553

Sample Part No. on Holster:
6005-83-121-DR



How to Order
Duty Holsters
Duty Accessories
Tactical Holsters
Tactical Accessories
Duty Belts
QAS
Speed Loaders
Light Systems
Concealment Holsters
Concealment Accessories
Competition
Apparel
Sales Support
Index/Price List

Tactical Accessories

6009VE D-RING STRAP WITH ENHANCED HOOK & LOOP BELT ATTACHMENT



DESCRIPTION	COLOR	PART NO.
D-Ring Strap w/Enhanced Hook & Loop Belt Attachment	Black	6009VE-7-2
	Foliage Green	6009VE-7-54
	Coyote Brown	6009VE-7-76
	OD Green	6009VE-7-56
	FDE Brown	6009VE-7-55

6009-10 SINGLE STRAP LEG SHROUD W/D-RING



DESCRIPTION	COLOR	PART NO.
Single Strap Leg Shroud w/ D-Ring	Black	6009-10-2
	Foliage Green	6009-10-54
	Coyote Brown	6009-10-76
	OD Green	6009-10-56
	FDE Brown	6009-10-55

Sample Part No. on Holster:
6005-83-121-SP10-DR

6009-110 LIGHTWEIGHT LEG SHROUD W/D-RING



DESCRIPTION	COLOR	PART NO.
Lightweight Leg Shroud w/ D-Ring	Black	6009-110-2
	Foliage Green	6009-110-54
	Coyote Brown	6009-110-76
	OD Green	6009-110-56
	FDE Brown	6009-110-55

Sample Part No. on Holster:
6005-83-121-LP-DR

6009-11 D-RING STRAP ONLY



DESCRIPTION	COLOR	PART NO.
D-Ring Leg Strap Only	Black	6009-11-2
	Foliage Green	6009-11-54
	Coyote Brown	6009-11-76
	OD Green	6009-11-56
	FDE Brown	6009-11-55

► Replacement Strap

Duty and Garrison Belts

031 D-RING BELT wLOOP LINING, 1.5" (38mm)

- ▶ Reinforced instructor-style belt
- ▶ Lined with loop material



FINISH	COLOR	SIZE	PART NO.
Plain	Black	X*	031-X-2
* 0 - Extra Small (24"-26")	1 - Small (28"-32")	2 - Medium (34"-36")	
3 - Large (38"-42")	4 - X-Large (44"-46")	5 - 2XL (48"-50")	
6 - 3XL (52"-54")	7 - 4XL (56"-58")		

51 GARRISON W/ SQUARE BUCKLE, 1.75" (45mm)

- ▶ Full grain leather construction
- ▶ Includes removable square chrome or brass buckle



FINISH	COLOR	BUCKLE	SIZE	PART NO.
Plain	Black	Chrome	XX*	51-XX-2
Plain	Black	Brass	XX*	51-XX-2B
Basket	Black	Chrome	XX*	51-XX-4
Basket	Black	Brass	XX*	51-XX-4B
Hi Gloss	Black	Chrome	XX*	51-XX-9
Hi Gloss	Black	Brass	XX*	51-XX-9B
Nylon Look	Black	Chrome	XX*	51-XX-22

*Model 51 is available in even sizes from 24" (61cm) to 44" (112cm). Sizes 46" (117cm) and above are available at additional cost (call for pricing). To order any belt, simply replace the XX in the part number with the proper size, i.e., 51-34-6. Before measuring for any belt, please read "Ordering a Belt" in the "How to Order" section.

87 SAM BROWNE BUCKLE, 2.25" (58mm)

- ▶ Standard duty belt with a suede lining
- ▶ 4-stitch design
- ▶ Double-tongued buckle and center belt stud fasten belt firmly around waist
- ▶ Free-sliding keeper holds the belt tip in place
- ▶ Choice of chrome or brass buckle



FINISH	COLOR	BUCKLE	SIZE	PART NO.
Plain	Black	Chrome	XX*	87-XX-6 ALR†
Plain	Black	Brass	XX*	87-XX-6B ALR†
Basket	Black	Chrome	XX*	87-XX-8 ALR†
Basket	Black	Brass	XX*	87-XX-8B ALR†
Hi Gloss	Black	Chrome	XX*	87-XX-9 ALR†
Hi Gloss	Black	Brass	XX*	87-XX-9B ALR†
Nylon Look	Black	Chrome	XX*	87-XX-26 ALR†

*Model 87 is available in even sizes from 24" (61cm) to 44" (112cm). Sizes 46" (117cm) and above are available at additional cost (call for pricing). To order any belt, simply replace the XX in the part number with the proper size, i.e., 87-34-6. Before measuring for any belt, please read "Ordering a Belt" in the "How to Order" section.

† Model is available for the Alert Belt System

How to Order
Duty Holsters
Duty Accessories
Tactical Holsters
Tactical Accessories
Duty Belts
QAS
Speed Loaders
Light Systems
Concealment Holsters
Concealment Accessories
Competition
Apparel
Sales Support
Index/Price List

Duty and Garrison Belts

87V SAM BROWNE W/ HOOK LINING, 2.25" (58mm)



- ▶ Hook lined
- ▶ Standard duty belt with a suede lining
- ▶ 4-stitch design
- ▶ Double-tongued buckle and center belt stud fasten belt firmly around waist
- ▶ Free-sliding keeper holds the belt tip in place
- ▶ Choice of chrome or brass buckle
- ▶ 87V with hook and loop

FINISH	COLOR	BUCKLE	SIZE	PART NO.
Plain	Black	Chrome	XX*	87V-XX-6
Plain	Black	Brass	XX*	87V-XX-6B
Basket	Black	Chrome	XX*	87V-XX-8
Basket	Black	Brass	XX*	87V-XX-8B
Hi Gloss	Black	Chrome	XX*	87V-XX-9
Hi Gloss	Black	Brass	XX*	87V-XX-9B
Nylon Look	Black	Chrome	XX*	87V-XX-26

*Model 87V is available in even sizes from 24" (61cm) to 44" (112cm). Sizes 46" (117cm) and above are available at additional cost (call for pricing). To order any belt, simply replace the XX in the part number with the proper size, i.e., 87V-34-6. Before measuring for any belt, please read "Ordering a Belt" in the "How to Order" section.

- Safariland's hook and loop Self Stick Kit (Model #183) works with Models 87V, 94, & 99 Buckleless™ duty belts. This set of hook and loop hook squares is ideal for fastening accessories to these belts.

94 BUCKLELESS™, W/ HOOK LINING, 2.25" (58mm), 2" (50mm)



- ▶ Features a hidden brass prongs and a hook and loop closure
- ▶ Belt is lined with a band of hook that can be attached to the lining on the Model 99 or 992, completing the Buckleless system

FINISH	COLOR	SIZE	PART NO.
Plain	Black	XX*	94-XX-2†
Basket	Black	XX*	94-XX-4†
Hi Gloss	Black	XX*	94-XX-9†
Nylon Look	Black	XX*	94-XX-22†

*Model 94 is available in even sizes from 24" (61cm) to 44" (112cm). Sizes 46" (117cm) and above are available at additional cost (call for pricing). To order any belt, simply replace the XX in the part number with the proper size, i.e., 94-34-2. Before measuring for any belt, please read "Ordering a Belt" in the "How to Order" section.

† Model 94 is part of the Alert Belt System

- Safariland's hook and loop Self Stick Kit (Model #183) works with Models 87V, 94, & 99 Buckleless™ duty belts. This set of hook and loop hook squares is ideal for fastening accessories to these belts.

Available in 2" (50mm) Sample Code 94-xx-2-50

94P BUCKLELESS™, W/O HOOK LINING, 2.25" (58mm)



- ▶ Features a hidden brass prongs and a hook and loop closure

FINISH	COLOR	SIZE	PART NO.
Plain	Black	XX*	94P-XX-2
Basket	Black	XX*	94P-XX-4
Hi Gloss	Black	XX*	94P-XX-9
Nylon Look	Black	XX*	94P-XX-22

*Model 94P is available in even sizes from 24" (61cm) to 44" (112cm). Sizes 46" (117cm) and above are available at additional cost (call for pricing). To order any belt, simply replace the XX in the part number with the proper size, i.e., 94P-34-2. Before measuring for any belt, please read "Ordering a Belt" in the "How to Order" section.

Duty and Garrison Belts

99 BUCKLELESS™, REVERSIBLE, 1.5" (38mm)

- ▶ Hook and loop closure
- ▶ Loop lined
- ▶ Can be used with models 94, 87V or other hook lined belt



FINISH	COLOR	SIZE	PART NO.
Plain	Black	X*	99-X-2
Basket	Black	X*	99-X-4
Hi Gloss	Black	X*	99-X-9
Nylon Look	Black	X*	99-X-22

*Model 99 is available from size Extra Small to Large. Sizes X-Large and XX-Large are available at additional cost (call for pricing). To order, simply replace the X in the part number with the proper size, i.e., 99-3-2. For belts 48" and up, insert the even belt size in place of the X.

* 0 - Extra Small (24"-26") 1 - Small (28"-32") 2 - Medium (34"-36")
 3 - Large (38"-42") 4 - X-Large (44"-46") 5 - 2XL (48"-50")
 6 - 3XL (52"-54") 7 - 4XL (56"-58")

- Safariland's hook and loop Self Stick Kit (Model #183) works with Models 87V, 94, & 99 Buckleless™ duty belts. This set of hook and loop hook squares is ideal for fastening accessories to these belts.

146 BORDER PATROL, 2.25" (58mm)

- ▶ Standard buckle fastens the belt firmly around the waist
- ▶ The 1.25" (32mm) and 2.25" (58mm) keepers hold the interior and exterior belt tips in place
- ▶ Choice of chrome or brass buckle



FINISH	COLOR	PBUCKLE	SIZE	PART NO.
Plain	Black	Chrome	XX*	146-XX-2
Plain	Black	Brass	XX*	146-XX-2B
Basket	Black	Chrome	XX*	146-XX-4
Basket	Black	Brass	XX*	146-XX-4B
Hi Gloss	Black	Chrome	XX*	146-XX-9
Hi Gloss	Black	Brass	XX*	146-XX-9B
Nylon Look	Black	Chrome	XX*	146-XX-22
Nylon Look	Black	Brass	XX*	146-XX-22B

*Model 146 is available in even sizes from 24" (61cm) to 44" (112cm). Sizes 46" (117cm) and above are available at additional cost (call for pricing). To order any belt, simply replace the XX in the part number with the proper size, i.e., 146-34-2. Before measuring for any belt, please read "Ordering a Belt" in the "How to Order" section.

How to Order
Duty Holsters
Duty Accessories
Tactical Holsters
Tactical Accessories
Duty Belts
QAS
Speed Loaders
Light Systems
Concealment Holsters
Concealment Accessories
Competition
Apparel
Sales Support
Index/Price List

Duty and Garrison Belts

146V BORDER PATROL W/ HOOK LINING, 2.25" (58mm)



- ▶ Standard buckle fastens the belt firmly around the waist
- ▶ The 1.25" (32mm) and 2.25" (58mm) keepers hold the interior and exterior belt tips in place
- ▶ Hook lined
- ▶ Choice of chrome or brass buckle

FINISH	COLOR	PBUCKLE	SIZE	PART NO.
Plain	Black	Chrome	XX*	146V-XX-2
Plain	Black	Brass	XX*	146V-XX-2B
Basket	Black	Chrome	XX*	146V-XX-4
Basket	Black	Brass	XX*	146V-XX-4B
Hi Gloss	Black	Chrome	XX*	146V-XX-9
Hi Gloss	Black	Brass	XX*	146V-XX-9B
Nylon Look	Black	Chrome	XX*	146V-XX-22
Nylon Look	Black	Brass	XX*	146V-XX-22B

*Model 146V is available in even sizes from 24" (61cm) to 44" (112cm). Sizes 46" (117cm) and above are available at additional cost (call for pricing). To order any belt, simply replace the XX in the part number with the proper size, i.e., 146-34-2. Before measuring for any belt, please read "Ordering a Belt" in the "How to Order" section.

872 CONTOURED DUTY BELT, 2.25" (58mm)

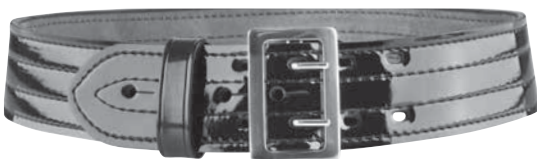

- ▶ 4-stitch design with suede lining and free-sliding keeper to hold belt tip in place
- ▶ 2.25" (58mm) duty belt is contoured for proper alignment and greater comfort
- ▶ Greater all-day comfort by distributing weight evenly; no sharp edges to dig into hips
- ▶ Choice of chrome or brass buckle

FINISH	COLOR	PBUCKLE	SIZE	PART NO.
Plain	Black	Chrome	XX*	872-XX-6
Plain	Black	Brass	XX*	872-XX-6B
Basket	Black	Chrome	XX*	872-XX-8
Basket	Black	Brass	XX*	872-XX-8B
Hi Gloss	Black	Chrome	XX*	872-XX-9
Hi Gloss	Black	Brass	XX*	872-XX-9B

*Model 872V is available in even sizes from 24" (61cm) to 44" (112cm). Sizes 46" (117cm) and above are available at additional cost (call for pricing). To order any belt, simply replace the XX in the part number with the proper size, i.e., 87-34-6. Before measuring for any belt, please read "Ordering a Belt" in the "How to Order" section.

Duty and Garrison Belts

875 SAM BROWNE DUTY BELT, 2.25" (58mm)

- ▶ Standard duty belt with a plain border stitch
- ▶ Double-tongued buckle and center belt stud fasten belt firmly around waist
- ▶ Choice of chrome or brass buckle



FINISH	COLOR	PBUCKLE	SIZE	PART NO.
Plain	Black	Chrome	XX*	875-XX-6
Plain	Black	Brass	XX*	875-XX-6B
Basket	Black	Chrome	XX*	875-XX-8
Basket	Black	Brass	XX*	875-XX-8B
Hi Gloss	Black	Chrome	XX*	875-XX-9
Hi Gloss	Black	Brass	XX*	875-XX-9B
Nylon Look	Black	Chrome	XX*	875-XX-22
Nylon Look	Black	Brass	XX*	875-XX-22B

*Model 875 is available in even sizes from 24" (61cm) to 44" (112cm). Sizes 46" (117cm) and above are available at additional cost (call for pricing). To order any belt, simply replace the XX in the part number with the proper size, i.e., 875-34-6. Before measuring for any belt, please read "Ordering a Belt" in the "How to Order" section.

942 CONTOURED DUTY BELT W/ HOOK LINING 2.25" (58mm), 2" (50mm)

- ▶ Tip of belt points to the right side of the officer
- ▶ Greater all-day comfort by distributing weight evenly; no sharp edges to dig into hips
- ▶ Lined with hook to mate with 99 liner belt
- ▶ Features hidden brass prongs and a hook and loop closure



FINISH	COLOR	PBUCKLE	SIZE	PART NO.
			2" (50mm)	2.25" (58mm)
Plain	Black	XX*	942-XX-2-50	942-XX-2
Basket	Black	XX*	942-XX-4-50	942-XX-4
Hi Gloss	Black	XX*	942-XX-9-50	942-XX-9
Nylon Look	Black	XX*	942-XX-22-50	942-XX-22

*Model 942 is available in even sizes from 24" (61cm) to 44" (112cm). Sizes 46" (117cm) and above are available at additional cost (call for pricing). To order any belt, simply replace the XX in the part number with the proper size, i.e., 942-34-2. Before measuring for any belt, please read "Ordering a Belt" in the "How to Order" section.

942P CONTOURED DUTY BELT, 2.25" (58mm)

- ▶ Tip of belt points to the right side of the officer
- ▶ Greater all-day comfort by distributing weight evenly; no sharp edges to dig into hips
- ▶ Features hidden brass prongs and a hook and loop closure



FINISH	COLOR	SIZE	PART NO.
Plain	Black	XX*	942P-XX-2
Basket	Black	XX*	942P-XX-4
Hi Gloss	Black	XX*	942P-XX-9
Nylon Look	Black	XX*	942P-XX-22

*Model 942P is available in even sizes from 24" (61cm) to 44" (112cm). Sizes 46" (117cm) and above are available at additional cost (call for pricing). To order any belt, simply replace the XX in the part number with the proper size, i.e., 942P-34-2. Before measuring for any belt, please read "Ordering a Belt" in the "How to Order" section.

How to Order
Duty Holsters
Duty Accessories
Tactical Holsters
Tactical Accessories
Duty Belts
QAS
Speed Loaders
Light Systems
Concealment Holsters
Concealment Accessories
Competition
Apparel
Sales Support
Index/Price List

Duty and Garrison Belts

992 BUCKLELESS™ REVERSIBLE, CONTOUR, 1.5" (38mm)



- ▶ Lined with loop material
- ▶ Designed to be worn under duty belts with hook as the foundation of the Safariland™ belt systems
- ▶ The 992 is the contour version of the 99

FINISH	COLOR	SIZE	PART NO.
Plain	Black	X*	992-X-2
Hi Gloss	Black	X*	992-X-9
Nylon Look	Black	X*	992-X-22

*Model 992 is available from size Small to X-Large. To order, simply replace the X in the part number with the proper size.

* 1 - Small (28"-32")	2 - Medium (34"-36")	3 - Large (38"-42")
4 - X-Large (44"-46")	5 - 2XL (48"-50")	6 - 3XL (52"-54")
7 - 4XL (56"-58")		

999 GARRISON HOOK AND LOOP CLOSURE, 1.5" (38mm)



- ▶ Hook and loop closure
- ▶ Unlined

FINISH	COLOR	SIZE	PART NO.
Plain	Black	X*	999-X-2
Basket	Black	X*	999-X-4
Hi Gloss	Black	X*	999-X-9
Nylon Look	Black	X*	999-X-22

*Model 999 is available from size Extra Small to Large. Sizes X-Large and XX-Large are available at additional cost (call for pricing). To order, simply replace the X in the part number with the proper size, i.e., 999-3-2. For belts 48" (122cm) and up, insert the even belt size in place of the X.

* 0 - Extra Small (24"-26")	1 - Small (28"-32")	2 - Medium (34"-36")	3 - Large (38"-42")
4 - X-Large (44"-46")	5 - 2XL (50"-52")	6 - 3XL (54"-56")	7 - 4XL (56"-58")

Duty and Garrison Belts

4320 PADDED BELT LINER

- ▶ Provides a padded buffer between duty belt and body
- ▶ Helps eliminate possible bruising and other comfort issues associated with wearing a duty belt for long periods of time



BELT WIDTH	COLOR	PART NO.
2" (50mm)	Black	4320-XX-4-50
2.25" (58mm)	Black	4320-XX-4-225

*Model 4320 is available in even sizes from 24" (61cm) to 44" (112cm). Sizes 46" (117cm) and above are available at additional cost (call for pricing). To order any belt, simply replace the X in the part number with the proper size, i.e. 4320-34-4. Before measuring for any belt, please read "Ordering a Belt" in the "How to Order" section.

4325 BUCKLELESS™ REVERSIBLE BELT, LOOP LINED

- ▶ Hook and loop closure
- ▶ Lined with loop



SIZE	WAIST SIZE	COLOR	PART NO.
Extra Small Pants	Size 20 to 26"	Black	4325-0-4
Small Pants	Size 26 to 32"	Black	4325-1-4
Medium Pants	Size 32 to 38"	Black	4325-2-4
Large Pants	Size 38 to 44"	Black	4325-3-4
X-Large Pants	Size 44 to 50"	Black	4325-4-4
XX-Large Pants	Size 50 to 56"	Black	4325-5-4
XXX-Large Pants	Size 56 to 62"	Black	4325-6-4

4330 PADDED BELT LINER

- ▶ 3" padded belt liner for use with duty or tactical belts
- ▶ Padding extends beyond edges of belt to help with weight distribution and remove pinch point
- ▶ Anti-bacterial and anti-microbial mesh interior liner



BELT WIDTH	COLOR	PART NO.
3" (76mm)	Black	4330-XX-4-3

*Model 4330 is available in even sizes from 24" (61cm) to 44" (112cm). Sizes 46" (117cm) and above are available at additional cost (call for pricing). To order any belt, simply replace the X in the part number with the proper size, i.e. 4330-34-4. Before measuring for any belt, please read "Ordering a Belt" in the "How to Order" section.

How to Order
Duty Holsters
Duty Accessories
Tactical Holsters
Tactical Accessories
Duty Belts
QAS
Speed Loaders
Light Systems
Concealment Holsters
Concealment Accessories
Competition
Apparel
Sales Support
Index/Price List

Duty and Garrison Belts

4832 LIGHTWEIGHT DUTY BELT



- ▶ Features hidden brass hook closure
- ▶ Features full length hook lining for use with Bianchi® 8106 liner belt or Safariland 4325 liner belt
- ▶ Lightweight design; about 30% lighter weight
- ▶ Available in Black, Basketweave, and Hi Gloss finishes

FINISH	COLOR	BUCKLE	SIZE	PART NO.
Plain	Black	XX	XX	4832-XX-2
Basket	Black	XX	XX	4832-XX-4
Hi Gloss	Black	XX	XX	4832-XX-9

*Model 4832 is available in even sizes from 24" (61cm) to 44" (112cm). Sizes 46" (117cm) and above are available at additional cost (call for pricing). To order any belt, simply replace the X in the part number with the proper size, i.e. 4832-34-4. Before measuring for any belt, please read "Ordering a Belt" in the "How to Order" section.

REPLACEMENT BELT BUCKLES



FINISH	PART NO.
Replacement Chrome Buckle - Model 51	B-651
Replacement Brass Buckle - Model 51	B-651B
Replacement Chrome Buckle - Models 87, 87V, 872V, 875	B-602
Replacement Brass Buckle - Models 87, 87V, 872V, 875	B-602B
Replacement Chrome Buckle - Models 146, 146V	B-146
Replacement Brass Buckle - Models 146, 146V	B-146B
Replace 3X Locking Buckle - Model 94243 2" (50mm)	B4305-2-2
2.25" (58mm) Buckle - Model 4305	B4305-2-225

P-2200 DUTY BELT LOOP INSERT ADAPTER



- ▶ Accessory designed to work with Safariland duty holsters with 2.25" (58mm) OBL belt loops
- ▶ Injection molded insert that allows these holsters to be used with standard 2" (50mm) nylon belts

FINISH	SIZE	PART NO.
Plain	Black	P-2200

Model P-2200 is designed to fit the 2.25" (58mm) belt loops.

P-2201 DUTY HOLSTER UBL INSERT ADAPTER



FINISH	SIZE	PART NO.
Plain	Black	P-2201

Accessory insert for UBL (Universal Belt Loop) to be used on 2" (50mm) belts.

Quick Attachment Systems

ELS 34 EQUIPMENT LOCKING FORK

- ▶ Includes two locking forks
- ▶ Equipment Locking Fork locks into ELS 35 Accessory Receiver
- ▶ Attaches to any tactical accessory, including the 774 Rifle Mag Pouch, 76 Single Mag Pouch, 78 Slimline Dual Magazine Pouch, and Impact Round cases
- ▶ A quick pinch of the thumb and index finger allows the removal of any product attached to the unit for attachment on any other ELS 35 location
- ▶ Permits the user to quickly rotate or adjust which accessories are carried, depending on the mission at hand



PATENTED

Mounts directly to the back of any tactical accessory and connects to the ELS 35 Receiver Plate.

FINISH	SIZE	PART NO.
Locking Fork	Black	6004-34-2
	Foliage Green	6004-34-54
	Coyote Brown	6004-34-76
	OD Green	6004-34-56
	FDE Brown	6004-34-55

Description	Sample Part No.
ELS 34 Only	771-53-121-MS34
ELS 34 & ELS 35	771-53-121-MS36

ELS 35 EQUIPMENT RECEIVER PLATE

- ▶ Includes two receiver plates
- ▶ ELS 35 Equipment Receiver Plate works with the ELS 34 to lock accessories
- ▶ Attaches to any tactical thigh rig or any other two-hole accessory location including ELS tactical and competition belt
- ▶ A quick pinch of the thumb and index finger allows the removal of any product attached to the unit for attachment on any other ELS 35 location
- ▶ Permits the user to quickly rotate or adjust which accessories are carried, depending on the mission at hand
- ▶ May be purchased or placed directly on to 744BL belt clip for convenient waistline location



PATENTED

Mounting platform for the ELS 34 Locking Fork attaches directly to the tactical thigh rig or ELS belt.

FINISH	SIZE	PART NO.
Receiver Plate	Black	6004-35-2
	Foliage Green	6004-35-54
	Coyote Brown	6004-35-76
	OD Green	6004-35-56
	FDE Brown	6004-35-55

Description	Sample Part No.
ELS 35 Only	744BL-2-MS35
ELS 34 & ELS 35	771-53-121-MS36

Quick Attachment Systems

MLS 16 MOLLE ACCESSORY LOCKING FORK



PATENTED

Threads directly through MOLLE loops to mount pouches. MLS 16 can be used with QLS 19, QLS 22 or ELS 35 for quick attachment of accessories or attachment of receiver plates to MOLLE looped products.

- ▶ Can be threaded directly through MOLLE loops
- ▶ Permits the user to quickly rotate or adjust which accessories are carried, depending on the mission at hand. MLS 16 can be ordered with any tactical accessory or, with the QLS 19 attached

DESCRIPTION	SIZE	PART NO.
Accessory Locking Fork	Black	6004-16-2
	Foliage Green	6004-16-54
	Coyote Brown	6004-16-76
	OD Green	6004-16-56
	FDE Brown	6004-16-55

Description	Sample Part No.
MLS 16 ONLY on accessory body	77-XX-23PBL-MS16
MLS 16 attached to back of QLS 22	6004-16-XX-MS22

QLS 19 QUICK LOCKING FORK



PATENTED

Mounts directly to the back of duty holsters then connects to the QLS 22 Receiver Plate. Passes Level I Retention™ pull test. QLS 19 can be used with QLS 22 ONLY for quick attachment to holsters while retaining a Level I Retention.

- ▶ QLS 19 Locking Fork locks into the QLS 22 Receiver Plate ONLY
- ▶ Attaches to any Safariland holster with the 3-hole pattern and maintains a Level I Retention™
- ▶ A quick pinch of the thumb and index finger allows the removal of any product attached to the unit for attachment on any other QLS 22 location
- ▶ Permits the user to quickly rotate or adjust which accessories are carried, depending on the mission at hand

DESCRIPTION	SIZE	PART NO.
Holster Locking Fork	Black	6004-19-2
	Foliage Green	6004-19-54
	Coyote Brown	6004-19-76
	OD Green	6004-19-56
	FDE Brown	6004-19-55

Description	Sample Part No.
QLS 19 w/ QLS 22 on holster body w/ paddle	6378-XX-411-MS30
QLS 19 on holster body ONLY	7304-XX-411-MS19

Quick Attachment Systems

QLS 22/QLS 22L QUICK LOCKING RECEIVER PLATE

- ▶ QLS 22 Receiver Plate works with the QLS 19 or can be used with the MLS 16 attached to the back for use on MOLLE looped equipment
- ▶ Attaches to any Safariland Holster with the 3-hole pattern and maintains a Level I Retention
- ▶ A quick pinch of the thumb and index finger allows the removal of any product attached to the unit for attachment on any other QLS 19 location
- ▶ Permits the user to quickly rotate or adjust which accessories are carried, depending on the mission at hand

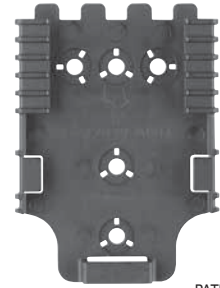

PATENTED

Mounting platform for the QLS 19 Duty Locking Fork. Attaches directly to Universal Belt Loop (UBL). Passes Level I Retention™ pull test.

DESCRIPTION	SIZE	PART NO.
Receiver Plate	Black	6004-22-2
	Foliage Green	6004-22-54
	Coyote Brown	6004-22-76
	OD Green	6004-22-56
	FDE Brown	6004-22-55
Receiver Plate w/ additional locking feature	Black	6004-22L-2
	Foliage Green	6004-22L-54

Description	Sample Part No.
QLS 19 w/ QLS 22 on holster body w/ paddle	6378-XX-411-MS30
QLS 22 w/ MLS 16 attached to back	6004-16-2-MS22

ELS-KIT EQUIPMENT LOCKING KIT

DESCRIPTION	SIZE	PART NO.
(2) ELS 34 & ELS 35	Black	ELS-KIT1-2
	Foliage Green	ELS-KIT1-54
	Coyote Brown	ELS-KIT1-76
	OD Green	ELS-KIT1-56
	FDE Brown	ELS-KIT1-55
Dealer 10-Pack	Black	ELS-KIT1-2-10
	Foliage Green	ELS-KIT1-54-10
	Coyote Brown	ELS-KIT1-76-10
	OD Green	ELS-KIT1-56-10
	FDE Brown	ELS-KIT1-55-10
Dealer 50-Pack	Black	ELS-KIT1-2-50
	Foliage Green	ELS-KIT1-54-50
	Coyote Brown	ELS-KIT1-76-50
	OD Green	ELS-KIT1-56-50
	FDE Brown	ELS-KIT1-55-50
Dealer 100-Pack	Black	ELS-KIT1-2-100
	Foliage Green	ELS-KIT1-54-100
	Coyote Brown	ELS-KIT1-76-100
	OD Green	ELS-KIT1-56-100
	FDE Brown	ELS-KIT1-55-100

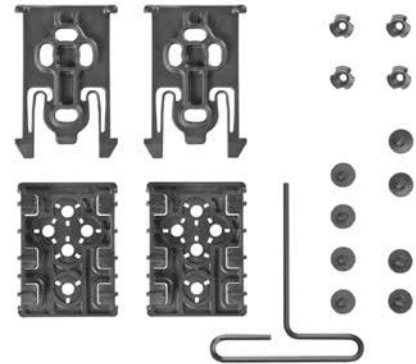

PATENTED

ELS SYSTEM KIT includes:
(2) ELS 34 units and (2) ELS 35 units

Quick Attachment Systems

QUICK LOCKING SYSTEM KITS

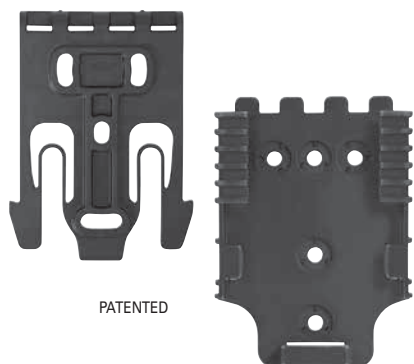

PATENTED

▶ Passes Level I Retention™ pull test.

DESCRIPTION	SIZE	PART NO.
Quick-Kit1 (1) QLS 19, (1) QLS 22	Black Foliage Green Coyote Brown OD Green FDE Brown	QUICK-KIT1-2 QUICK-KIT1-54 QUICK-KIT1-76 QUICK-KIT1-56 QUICK-KIT1-55
Quick-Kit2 (1) QLS 19, (1) QLS 22L	Black Foliage Green	QUICK-KIT2-2 QUICK-KIT2-54
Quick-Kit3 (1) QLS 19, (2) QLS 22	Black Foliage Green Coyote Brown OD Green FDE Brown	QUICK-KIT3-2 QUICK-KIT3-54 QUICK-KIT3-76 QUICK-KIT3-56 QUICK-KIT3-55
Quick-Kit4 (1) QLS 19, (2) QLS 22L	Black Foliage Green	QUICK-KIT4-2 QUICK-KIT4-54

QUICK LOCKING SYSTEM

KIT Includes:

- QLS 19 - 6004-19
- QLS 22 - 6004-22
- Hardware

*QLS Kits can also be ordered in 10, 50, or 100 packs
 Sample Part Number 10 Pack
 QUICK-KIT1-2-10
 Sample Part Number 50 Pack
 QUICK-KIT2-2-50
 Sample Part Number 100 Pack
 QUICK-KIT1-2-100

6004-24 MLS 16 ON MOLLE PLATE



PATENTED

- ▶ A mount with the MLS 16 Accessory Fork already affixed; attaches to existing MOLLE pouches then easily threaded through MOLLE loops.
- ▶ Can be attached to a receiver plate, then mounted on a MOLLE vest, thigh rigged, belt, or other attachment point.
- ▶ Allows user to rearrange gear quickly and easily

DESCRIPTION	SIZE	PART NO.
MLS Accessory Fork on Small MOLLE Plate	Black Foliage Green Coyote Brown OD Green FDE Brown	6004-24-2 6004-24-54 6004-24-76 6004-24-56 6004-24-55

Speedloaders & Accessories

COMP I SPEEDLOADER

- ▶ Injection-molded construction
- ▶ Popular for concealment
- ▶ Features a small knob providing maximum concealment for small frame revolvers
- ▶ Large-frame versions offer maximum grip clearance
- ▶ IDPA Approved

DESCRIPTION	GUN	FIT	PART NO.
Comp I Speedloader	Charter Arms	5-shot .38 Special	J-C7
	Colt	Anaconda .44 Magnum	J-S5
	Ruger	Redhawk .44 Magnum	J-S5
	S&W	5-shot .38 Special J Frame	J-C7
	S&W	M60 357 Magnum	J-C7
	S&W	N Frame 29, 629, 624, .44	J-S5

See page 281 for the Safariland Loading Block



Safariland offers Training DVDs for various products. For more information on this product please review TV-1001D Speedloader Review.

COMP II SPEEDLOADER

- ▶ Injection-molded construction
- ▶ Popular for duty use
- ▶ Features a small knob providing maximum concealment for small-frame revolvers
- ▶ Medium-size knob for ease of locking closed
- ▶ Large-frame versions offer maximum grip clearance
- ▶ IDPA Approved

DESCRIPTION	GUN	FIT	PART NO.
Comp II Speedloader	Colt	Match, Official Police, Officer's, Old Model Trooper, Python	J-P3C
	Dan Wesson	.38/357	J-K2C
	Chiappa Rhino. 357, Ruger J-R4C	Model GP100	J-GL8C
	S&W	Security Six, Service Six, Speed Six	J-R4C
	S&W	K Frame 10, 12, 13, 14, 15, 19, 64, 65, 66, 67, 68	J-K2C
	S&W Taurus	L Frame 581, 586, 681, 686, 66, 669, 689	J-GL8C J-K2C

See page 281 for the Safariland Loading Block



Safariland offers Training DVDs for various products. For more information on this product please review TV-1001D Speedloader Review.

COMP III SPEEDLOADER

- ▶ Injection-molded construction
- ▶ Popular for competition
- ▶ Spring-driven to offer the fastest weapon reloading device
- ▶ IDPA Approved

DESCRIPTION	GUN	FIT	PART NO.
Comp III Speedloader	Ruger	Model GP100	J-GL8S
	Dan Wesson	.38/357	J-K2S
	S&W	K Frame 10, 12, 13, 14, 15, 19, 64, 65, 66, 67, 68	J-K2S
	S&W	L Frame 581, 586, 681, 686	J-GL8S

See page 281 for the Safariland Loading Block



Safariland offers Training DVDs for various products. For more information on this product please review TV-1001D Speedloader Review.

Speedloaders & Accessories

CD-2 HOLDER, 2" (50mm) BELT CLIP



- ▶ Strong, epoxy-coated steel clips
- ▶ Lined with a vinyl pad insert to ensure loader stability
- ▶ CD-2 clips firmly onto any belt up to 2" (50mm) wide
- ▶ Metal clip-on construction

DESCRIPTION	GUN	FIT	PART NO.
Black	Epoxy	N/A	CD-2*

*Fits Speedloaders designed for small frame 5-shot; medium frame 6-shot; S&W N frame; Colt Lawman, Python, and Trooper revolvers.

Safariland offers Training DVDs for various products. For more information on this product please review TV-1001D Speedloader Review.

333 TRIPLE SPEEDLOADER HOLDER



- ▶ Features external clips and molded loader cups for ultra-quick access—ideal for competition use

DESCRIPTION	GUN	FIT	PART NO.
Black	Plain	1.75" (45mm)	333-X*-2-175
Black	Plain	2.25" (58mm)	333-X*-2

*Model 333 is available to fit all three versions of our Speedloaders. To determine the proper part number, substitute one of the two fit codes below for the X in the part number, i.e., 333-2-2.
 2 - S&W K frame, Ruger Security Six, Service Six, Speed Six, Taurus 66, 669, 689
 3 - S&W L frame, Colt Python, Ruger GP100

Safariland offers Training DVDs for various products. For more information on this product please review TV-1001D Speedloader Review.

Speedloaders & Accessories

340 DUAL SPEEDLOADER POUCH, 2.25" (58mm) BELT LOOP

- ▶ Standard double speedloader
- ▶ Fits 2.25" (58mm) duty belts
- ▶ Chrome or brass snap



DESCRIPTION	FINISH	SNAP	PART NO.
Black	Plain	Chrome	340-X*-2
Black	Plain	Brass	340-X*-2B
Black	Basket	Chrome	340-X*-4
Black	Basket	Brass	340-X*-4B
Black	Hi Gloss	Chrome	340-X*-9
Black	Hi Gloss	Brass	340-X*-9B

*Available with Nylon Look finish. Sample Code 340-x-22PBL

*Model 340 is available to fit several different versions of our Comp I and Comp II Speedloaders. To determine the proper part number, substitute one of the fit codes below for the X in the part number, i.e., 340-2-2.

- 2 - S&W K Frame, Ruger Security Six, Service Six, Speed Six, Taurus 66, 669, 689
- 3 - S&W L Frame, Colt Python, Ruger GP100

Safariland offers Training DVDs for various products. For more information on this product please review TV-1001D Speedloader Review.

371 SPLIT-SIX POUCH, 1.5" - 1.75" (38mm - 45mm) BELT LOOP

- ▶ Featuring ultra-low profile and quick, easy, single-action draw, providing the fastest "top-flap" speedloader holder available
- ▶ Design carries cartridges on either side of the belt
- ▶ Allows user to grip both sides of the loader while unsnapping the top flap
- ▶ Fits 1.75" (45mm) belt widths

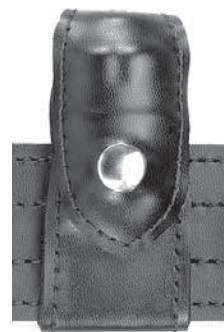

DESCRIPTION	FINISH	SNAP	COMP I NO.	COMP II NO.
Black	Plain	Chrome	371-1-6	371-2-6
Black	Plain	Brass	371-1-6B	371-2-6B
Black	Plain	Chrome	371-1-6*	N/A

*Available with Nylon Look finish. Sample Code 371-2-26PBL

- * For J frame 5-Shot speedloaders only
- * 1.5"-1.75" (38mm - 45mm)

NOTE: Comp I J-S5 N Frames use 371-2

Safariland offers Training DVDs for various products. For more information on this product please review TV-1001D Speedloader Review.

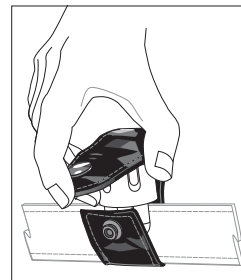

How to Order
Duty Holsters
Duty Accessories
Tactical Holsters
Tactical Accessories
Duty Belts
QAS
Speedloaders
Light Systems
Concealment Holsters
Concealment Accessories
Competition
Apparel
Sales Support
Index/Price List

Rapid Light System

RLS™ RAPID LIGHT SYSTEM

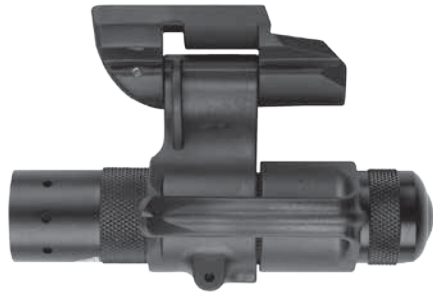

- ▶ Ambidextrous
- ▶ Super-bright LED technology (190 lumens)
- ▶ Bright enough to be your primary light. Prism Reflector System penetrates light up to 350 feet
- ▶ 3 AAAs (included) – no expensive proprietary batteries needed
- ▶ Integral clip for easy securement to belt or garment – no dedicated light mount holster required
- ▶ Fits most handgun models that incorporate an integral rail system – also mounts to rifles and shotguns that have a Picatinny rail
- ▶ Quickly transitions from standard flashlight to weapon illumination
- ▶ Can be operated with either thumb, or change to other side to operate with trigger finger. Push button provides controllable on/off illumination of target to minimize loss of handgrip, sight picture and exposure
- ▶ RLS™ mount will accommodate most hand-held compact lights in the range of .970 (24.6mm) - 1.060 (26.9mm) in diameter

Note: The RLS will also fit shotguns & rifles with Picatinny light rails and most handguns with standard light rails. Not available for handguns without light rails.

DESCRIPTION	PART NO.
RLS Mount System w/ Safariland LED Light	RLS-1-3-PIC1
RLS Mounting Unit Only	RLS-0-2-PIC1
RLS Mounting Unit Only Dealer 10-pack	RLS-0-2-PIC1-10
RLS Mount System w/ Safariland LED Flashlight Dealer 10-pack	RLS-1-3-PIC-10
Safariland LED Flashlight Only	LGT-1-3

RLSM MOUNT FOR DUTY BELT



Shown with light attached

- ▶ Slides on duty belt
- ▶ Provides a small mounting platform on duty belt to attach the RLS™ light
- ▶ Will also accommodate any light, laser, or other accessory that will fit on a Picatinny or light rail
- ▶ Fits belt widths up to 2.25" (58mm)
- ▶ Also fits on leg shroud or QAS Locking Fork
- ▶ Included with RLS

DESCRIPTION	PART NO.
Clip-on Mount for RLS or other handheld light for 1.5" (38mm) - 2.25" (58mm) duty belt or thigh rig	RLSM-2

Rapid Light System

RLSR REDUCTION SLEEVE

- ▶ Enables the RLS mounting system to be used with lights of both .90" and .80" diameters
- ▶ Slides inside RLS™ mount to easily accept narrower lights

DESCRIPTION	PART NO.
RLS Mounting System (2 pieces)	RLSR-2



RLSP RLS™ W/ PRESSURE SWITCH

- ▶ RLS™ Light System with tape pressure switch
- ▶ Eight inch cord for versatile positioning
- ▶ Pressure switch split for low 10 lumens or high 190 lumens

DESCRIPTION	PART NO.
RLS Light w/ Pressure Switch	RLSP-3



RRL ROGERS' RAIL LITE

- ▶ Ambidextrous design fits on any Picatinny/1913 rail
- ▶ Tail on/off switch is positioned right at shooters forward thumb
- ▶ Easy snap on and off installation
- ▶ Made of heavy duty polyurethane yet is extremely light weight
- ▶ External rib design for added strength and grip
- ▶ Streamlight® Microstream® 28 lumen flashlight included

DESCRIPTION	PART NO.
Rogers Rail Light	RRL-1



How to Order
Duty Holsters
Duty Accessories
Tactical Holsters
Tactical Accessories
Duty Belts
OAS
Speed Loaders
Light Systems
Concealment Holsters
Concealment Accessories
Competition
Apparel
Sales Support
Index/Price List

Concealment Holsters

18 INSIDE-THE-WAISTBAND HOLSTER FOR: PISTOLS



FEATURES

- ▶ Open-top design
- ▶ Firm SafariLaminate™ construction allows holster to stay open for ease of reholstering
- ▶ SafariSuede™, outer material grips clothing for less movement of holster
- ▶ Fits both 1.25" (32mm) and 1.5" (38mm) belt widths
- ▶ Double-snap belt loop is adjustable for cant angle
- ▶ Available in Black sueded finish



GUN DESCRIPTION	FINISH	COLOR	RIGHT	LEFT
Colt Commander 4.25" BBL	Plain	Black	18-51-61	18-51-62
Colt Government 1911 5" BBL	Plain	Black	18-53-61	18-53-62
Colt Officer's 3.5" BBL	Plain	Black	18-54-61	18-54-62
Glock 17, 22 4" BBL	Plain	Black	18-83-61	18-83-62
Glock 19,23 4" BBL	Plain	Black	18-283-61	18-283-62
Glock 26, 27 3.5" BBL	Plain	Black	18-183-61	18-183-62
Glock 43 3.39" BBL	Plain	Black	18-895-61	18-895-62
Ruger LC9 3.12" BBL	Plain	Black	18-84-61	18-84-62
Sig Sauer P239 3.625" BBL	Plain	Black	18-75-61	18-75-62
Sig Sauer P228, P229 3.9" BBL	Plain	Black	18-74-61	18-74-62
Sig Sauer P220, P226 4.41" BBL	Plain	Black	18-77-61	18-77-62
Sig Sauer P2022 3.9" BBL	Plain	Black	18-278-61	18-278-62
Smith & Wesson M&P 9mm, .40 4.25" BBL	Plain	Black	18-219-61	18-219-62
Smith & Wesson M&P Shield™ 3.1" BBL	Plain	Black	18-179-61	18-179-62
Springfield Armory XD 9mm Sub-Compact 3.3" BBL	Plain	Black	18-47-61	18-47-62
Springfield XD-S 3.3" BBL	Plain	Black	18-45-61	18-45-62

Concealment Holsters

18 INSIDE-THE-WAISTBAND HOLSTER FOR: REVOLVERS

FEATURES

- ▶ Open-top design
- ▶ Firm SafariLaminate™ construction allows holster to stay open for ease of reholstering
- ▶ SafariSuede™, outer material grips clothing for less movement of holster
- ▶ Fits both 1.25" (32mm) and 1.5" (38mm) belt widths
- ▶ Double-snap belt loop is adjustable for cant angle
- ▶ Available in Black sueded finish



GUN DESCRIPTION	FINISH	COLOR	RIGHT	LEFT
Ruger LCR 38 Special 1.875" BBL	Plain	Black	18-01-61	18-01-62
Smith & Wesson J Small Frame 31, 34, 36, 37 2" BBL	Plain	Black	18-01-61	18-01-62

22 WALLET PROFILE HOLSTER FOR: PISTOLS

FEATURES

- ▶ Back of holster is designed to give "print" impression of a wallet
- ▶ Hinged design allows backing to swing away from holster, for a sure grip on the weapon and easy draw
- ▶ Holster will stay open; simply drop handgun into the pocket and it holsters itself
- ▶ Suede outer material grips clothing for less movement of holster
- ▶ Firm, moisture-proof membrane layer prevents perspiration from penetrating the holster and collecting on the gun
- ▶ Available in Black suede leather finish



GUN DESCRIPTION	FINISH	COLOR	RIGHT	LEFT
Kahr P380 2.5" BBL	Plain	Black	22-189-21	22-189-22
Kel Tec P3AT .380 ACP 2.75" BBL	Plain	Black	22-188-21	22-188-22
Ruger LCP .380 ACP 2.75" BBL	Plain	Black	22-188-21	22-188-22
Ruger LCP w/ Crimson Trace Laserguard 2.75" BBL	Plain	Black	22-1881-21	22-1881-22
Smith and Wesson Bodyguard .380 2.75" BBL XD 9mm Sub-Compact - 3" BBL	Plain	Black	22-194-21	22-194-22

How to Order
Duty Holsters
Duty Accessories
Tactical Holsters
Tactical Accessories
Duty Belts
QAS
Speed Loaders
Light Systems
Concealment Holsters
Concealment Accessories
Competition
Apparel
Sales Support
Index/Price List

Concealment Holsters

25 INSIDE-THE-POCKET HOLSTER FOR: PISTOLS



FEATURES

- ▶ Extra-thin, extra-soft holster for extra-deep concealment
- ▶ Holster will stay open; simply drop handgun into the pocket and it holsters itself
- ▶ Suede outer material grips clothing for less movement of holster
- ▶ Firm, moisture-proof membrane layer prevents perspiration from penetrating the holster and collecting on the gun
- ▶ Available in Black suede finish

GUN DESCRIPTION	FINISH	COLOR	RIGHT	LEFT
Glock 42 3.25" BBL	Plain	Black	25-894-21	25-894-22
Kahr PM9 3" BBL	Plain	Black	25-186-21	25-186-22
Kahr P380 2.5" BBL	Plain	Black	25-189-21	25-189-22
Kel Tec P3AT .380 ACP 2.75" BBL	Plain	Black	25-188-21	25-188-22
Ruger LCP .380 ACP 2.75" BBL	Plain	Black	25-188-21	25-188-22
Ruger LCP w/ Crimson Trace Laserguard 2.75" BBL	Plain	Black 2	25-1881-21	25-1881-22
Smith and Wesson Bodyguard .380 2.75" BBL	Plain	Black	25-194-21	25-194-22

25 INSIDE-THE-POCKET HOLSTER FOR: REVOLVERS



FEATURES

- ▶ Extra-thin, extra-soft holster for extra-deep concealment
- ▶ Holster will stay open; simply drop handgun into the pocket and it holsters itself
- ▶ Suede outer material grips clothing for less movement of holster
- ▶ Firm, moisture-proof membrane layer prevents perspiration from penetrating the holster and collecting on the gun
- ▶ Available in Black suede finish

GUN DESCRIPTION	FINISH	COLOR	RIGHT	LEFT
Colt Agent, Detective Special, DS-II, SF-VI 2" BBL	Plain	Black	25-01-21	25-01-22
Ruger LCR .38 Special 1.875" BBL	Plain	Black	25-01-21	25-01-22
Ruger SP101 2.25" BBL	Plain	Black	25-01-21	25-01-22
Smith & Wesson 31, 34, 36, 36LS, 37, 60, 60LS, 38HL, 49HL, 649HL, J Small Frame 2" BBL	Plain	Black	25-01-21	25-01-22
Taurus M-85 2" BBL	Plain	Black	25-01-21	25-01-22

Concealment Holsters

27 INSIDE-THE-PANTS HOLSTER FOR: PISTOLS

FEATURES

- ▶ J-shaped belt hook can be worn with any belt
- ▶ Open-top SafariLaminate™ holster designed as an undercover off-duty holster
- ▶ A polymer insert keeps the holster open for easy weapon reholstering
- ▶ Available in Plain Black finish



GUN DESCRIPTION	FINISH	COLOR	RIGHT	LEFT
AMT Hardballer, 5" BBL	Plain	Black	27-53-61	27-53-62
Colt Combat Elite, Delta Elite, Delta Gold Cup, Gold Cup Nat'l Match, Government 1911 5" BBL	Plain	Black	27-53-61	27-53-62
Colt Commander 4.25" BBL	Plain	Black	27-53-61	27-53-62
Colt Officers' 3.5" BBL	Plain	Black	27-54-61	27-54-62
CZ RAMI 3.00" BBL	Plain	Black	27-183-61	27-183-62
Glock 17, 22, 4.5" BBL	Plain	Black	27-83-61	27-83-62
Glock 26, 27, 3.5" BBL	Plain	Black	27-183-61	27-183-62
Glock 19, 23, 4" BBL	Plain	Black	27-283-61	27-283-62
Glock 42 3.25" BBL	Plain	Black	27-894-61	27-894-62
Glock 43 3.39" BBL	Plain	Black	27-895-61	27-895-62
Heckler & Koch P30, 3.875" BBL	Plain	Black	27-295-61	27-295-62
Kimber KIP45CUS, 5" BBL	Plain	Black	27-53-61	27-53-62
Para-Ordnance P14, 5" BBL	Plain	Black	27-53-61	27-53-62
Ruger SR9c, 3.4" BBL	Plain	Black	27-83-61	27-83-62
Ruger LC9, LC9S 3.1" BBL	Plain	Black	27-184-61	27-184-62
Sig Sauer P220, P226, 4.41" BBL P229, P225, P228, 3.86" BBL P230, 3.62" BBL	Plain	Black	27-77-61	27-77-62
Springfield Armory XD-S, 3.3" BBL	Plain	Black	27-45-61	27-45-62
Springfield Armory 1911-A1 5" BBL	Plain	Black	27-53-61	27-53-62

How to Order
Duty Holsters
Duty Accessories
Tactical Holsters
Tactical Accessories
Duty Belts
QAS
Speed Loaders
Light Systems
Concealment Holsters
Concealment Accessories
Competition
Apparel
Sales Support
Index/Price List

Concealment Holsters

27 INSIDE-THE-PANTS HOLSTER FOR: PISTOLS (continued)

GUN DESCRIPTION	FINISH	COLOR	RIGHT	LEFT
Smith & Wesson 39, 59, 439, 549, 639, 659, 3904, 3906, 4006, 4026, 5903, 5904, 5906, 5923, 5924, 5926, 5946, 4" BBL M&P .45 4.5" BBL	Plain	Black	27-83-61	27-83-62
Smith & Wesson 469, 669, 3913, 3913LS, 3913NL, 6926, 6946 3.5" BBL	Plain	Black	27-83-61	27-83-62
Smith & Wesson 4013, 4053 3.31" BBL	Plain	Black	27-53-61	27-53-62
Smith & Wesson 4516-1, 4536, 4556 3.75" BBL	Plain	Black	27-83-61	27-83-62
Smith & Wesson M&P SHIELD™ 9mm 3.1" BBL	Plain	Black	27-179-61	27-179-62

27 INSIDE-THE-PANTS HOLSTER FOR: REVOLVERS

FEATURES

- ▶ J-shaped belt hook can be worn with any belt
- ▶ Open-top SafariLaminate™ holster designed as an undercover off-duty holster
- ▶ A polymer insert keeps the holster open for easy weapon reholstering
- ▶ Available in Plain Black finish



GUN DESCRIPTION	FINISH	COLOR	RIGHT	LEFT
Colt Agent, Detective Special, DS-II, SF-VI 2" BBL	Plain	Black	27-01-61	27-01-62
Ruger LCR .38 Special 1.875" BBL	Plain	Black	27-01-61	27-01-62
Ruger SP101 2.25" BBL	Plain	Black	27-01-61	27-01-62
Smith & Wesson 31, 34, 36, 36LS, 37, 38ML, 49ML, 60, 60LS Airlite .22 Cal 2" BBL	Plain	Black	27-01-61	27-01-62
Taurus M-85 2" BBL	Plain	Black	27-01-61	27-01-62

Concealment Holsters

537 GLS™ OPEN TOP CONCEALMENT BELT SLIDE HOLSTER FOR: PISTOLS

FEATURES

- ▶ GLS™ (Grip Lock System) secures weapon once holstered; retention is deactivated with the middle finger upon a standard shooting grip on the weapon
- ▶ Soft, flexible holster body allows holster to mold around wearer
- ▶ Tension adjustment to customize tailor weapon fit to user preferences
- ▶ 1.5" (38mm) belt loops
- ▶ Available in Plain Black finish



GUN DESCRIPTION	FINISH	COLOR	RIGHT	LEFT
Glock 17, 22 4.5" BBL	Plain	Black	537-83-61	537-83-62
Glock 19, 23 4" BBL	Plain	Black	537-283-61	537-283-62
Glock 20, 21 4.6" BBL	Plain	Black	537-383-61	537-383-62
Heckler & Koch P30 3.78" BBL	Plain	Black	537-295-61	537-295-62
Heckler & Koch USP 9 Compact/P10 3.8" BBL	Plain	Black	537-391-61	537-391-62
Heckler & Koch USP 9/40 4.25" BBL	Plain	Black	537-391-61	537-391-62
Heckler & Koch USP 45 4.53" BBL	Plain	Black	537-391-61	537-391-62
Heckler & Koch USP 45C 3.80" BBL	Plain	Black	537-391-61	537-391-62
Heckler & Koch VP9 4.09" BBL	Plain	Black	537-391-61	537-391-62
Sig Sauer P220, P226, P220R, P226R, 9mm, .40 4.41" P227 9mm, .40 3.9" BBL	Plain	Black	537-774-61	537-774-62
Sig Sauer P229, P229R E2, P227 R3, P228 .40 3.9" BBL	Plain	Black	537-744-61	537-744-62
Sig Sauer P320 Compact & Carry 9mm, .40, .45 3.9" BBL	Plain	Black	537-750-61	537-750-62
Sig Sauer P320 9mm, .40, .45 4.7" BBL	Plain	Black	537-450-61	537-450-62
Sig Sauer SP2022 9mm, .40 3.9" BBL	Plain	Black	537-278-61	537-278-62
Smith & Wesson M&P 9mm, .40 4.25" BBL	Plain	Black	537-219-61	537-219-62
Springfield Armory XD(M) 9mm, .40 4.5" BBL	Plain	Black	537-146-61	537-146-62
Walther P99Q 4.00" BBL	Plain	Black	537-384-61	537-384-62

Concealment Holsters

547 PRD™ OPEN TOP CONCEALMENT BELT SLIDE HOLSTER FOR: PISTOLS



FEATURES

- ▶ Pinch Retention Device (PRD™) secures weapon once holstered by clamping onto both sides of the trigger guard when fully seated, draw is initiated by pulling through device
- ▶ 1.5" (38mm) belt loops
- ▶ Available in all STX Finishes
- ▶ Low profile with wide weight disbursement allowing for a comfortable carry and high concealability

GUN DESCRIPTION	FINISH	COLOR	RIGHT	LEFT
Glock 17, 22 4.5" BBL	STX Plain	Black	547-83-411	547-83-412
	STX Basket	Black	547-83-481	547-83-482
	STX Hi Gloss	Black	547-83-491	547-83-492
	STX Tactical	Black	547-83-131	547-83-132
Glock 19, 23 4" BBL	STX Plain	Black	547-283-411	547-283-412
	STX Basket	Black	547-283-481	547-283-482
	STX Hi Gloss	Black	547-283-491	547-283-492
	STX Tactical	Black	547-283-131	547-283-132
Glock 20, 21 4.6" BBL	STX Plain	Black	547-383-411	547-383-412
	STX Basket	Black	547-383-481	547-383-482
	STX Hi Gloss	Black	547-383-491	547-383-492
	STX Tactical	Black	547-383-131	547-383-132
Heckler & Koch P30 3.78" BBL	STX Plain	Black	547-391-411	547-391-412
	STX Basket	Black	547-391-481	547-391-482
	STX Hi Gloss	Black	547-391-491	547-391-492
	STX Tactical	Black	547-391-131	547-391-132
Heckler & Koch USP 9 Compact/P10 3.8" BBL	STX Plain	Black	547-391-411	547-391-412
	STX Basket	Black	547-391-481	547-391-482
	STX Hi Gloss	Black	547-391-491	547-391-492
	STX Tactical	Black	547-391-131	547-391-132
Sig Sauer P229, P229R E2, P227 R3, P228 .40 3.9" BBL	STX Plain	Black	547-744-411	547-744-412
	STX Basket	Black	547-744-481	547-744-482
	STX Hi Gloss	Black	547-744-491	547-744-492
	STX Tactical	Black	547-744-131	547-744-132
Sig Sauer P220, P226, P220R, P226R, 9mm, .40 4.41" P227 9mm, .40 3.9" BBL	STX Plain	Black	547-774-411	547-774-412
	STX Basket	Black	547-774-481	547-774-482
	STX Hi Gloss	Black	547-774-491	547-774-492
	STX Tactical	Black	547-774-131	547-774-132
Smith & Wesson M&P 9mm, .40 4.25" BBL	STX Plain	Black	547-219-411	547-219-412
	STX Basket	Black	547-219-481	547-219-482
	STX Hi Gloss	Black	547-219-491	547-219-492
	STX Tactical	Black	547-219-131	547-219-132
Smith & Wesson 1911 5" BBL	STX Plain	Black	547-53-411	547-53-412
	STX Basket	Black	547-53-481	547-53-482
	STX Hi Gloss	Black	547-53-491	547-53-492
	STX Tactical	Black	547-53-131	547-53-132
Springfield Armory XD(M) 9mm, .40 4.5" BBL	STX Plain	Black	547-146-411	547-146-412
	STX Basket	Black	547-146-481	547-146-482
	STX Hi Gloss	Black	547-146-491	547-146-492
	STX Tactical	Black	547-146-131	547-146-132
Springfield Armory 1911-A1 5" BBL	STX Plain	Black	547-53-411	547-53-412
	STX Basket	Black	547-53-481	547-53-482
	STX Hi Gloss	Black	547-53-491	547-53-492
	STX Tactical	Black	547-53-131	547-53-132
Walther P99Q 4.00" BBL	STX Plain	Black	547-384-411	547-384-412
	STX Basket	Black	547-384-481	547-384-482
	STX Hi Gloss	Black	547-384-491	547-384-492
	STX Tactical	Black	547-384-131	547-384-132

Concealment Holsters

566/567/568/569 CUSTOM FIT HOLSTERS FOR: PISTOLS



PATENTED

566 BELT SLIDE



PATENTED

567 BELT LOOP



PATENTED

568 PADDLE & BELT LOOP COMBO



back view



PATENTED & PATENT PENDING

569 BELT CLIP

FEATURES

- ▶ 6 pistol and 4 revolver fits accommodate over 200 different weapons
- ▶ IDPA approved
- ▶ Adjustable injection-molded belt loop fits 1.5" (38mm), 1.75" (45mm), and 2.25" (58mm) on models 567 & 568; please specify
- ▶ Belt loop is user-adjustable for cant angle; can even be worn cross draw
- ▶ Genuine SafariLaminate™ thermal-molded construction with suede lining to help protect the gun's finish
- ▶ Available in Plain Black finish

Model 567 is available in seven belt loop sizes:

Sample Codes:

567-09-411	1.5" Belt Slots w/ Cut-outs for 1.75" Belt Slots
567-09-411-150	1.5" Belt Slots
567-09-411-175	1.75" Belt Slots
567-09-411-50	2" Belt Slots
567-09-411-225	2.25" Belt Slots
567-09-411-DM	1.5" Belt Slots w/ Cut-outs for 1.75", 2" and 2.25" Belt Slots w/ 1" Drop
567-09-411-225DM	2.25" Belt Slots w/ 1" Drop



GUN DESCRIPTION	FINISH	COLOR	566		567		568		569	
			RIGHT	LEFT	RIGHT	LEFT	RIGHT	LEFT	RIGHT	LEFT
AMT Hardballer 5" BBL	STX Plain	Black	566-53-411	566-53-412	567-53-411	567-53-412	568-53-411	568-53-412	569-53-411	569-53-412
Beretta Px4 Storm 4" BBL	STX Plain	Black	566-744-411	566-744-412	567-744-411	567-744-412	568-744-411	568-744-412	569-744-411	569-744-412
Beretta 8000, 8040 G, F, D 3.6" BBL	STX Plain	Black	566-54-411	566-54-412	567-54-411	567-54-412	568-54-411	568-54-412	569-54-411	569-54-412
Beretta 92D, 92DM, 92DS, 92F, 92FS, 92G, 92 Brigadier FS, 92 Brigadier D, 96, 96D, 96DS Brigadier D, 96G, 96 Brigadier G, 96 Brigadier D 4.9" BBL	STX Plain	Black	566-53-411	566-53-412	567-53-411	567-53-412	568-53-411	568-53-412	569-53-411	569-53-412
Beretta 92FC, 92FCM, 92FCDA 4.25" BBL 92FS Centurion, 96DC, 96 Centurion 4.3" BBL	STX Plain	Black	566-51-411	566-51-412	567-51-411	567-51-412	568-51-411	568-51-412	569-51-411	569-51-412
Beretta 92 Vertec, 96 Vertec, 90-Two, 92 Brigadier 4.3" BBL	STX Plain	Black	566-49-411	566-49-412	567-49-411	567-49-412	568-49-411	568-49-412	569-49-411	569-49-412

Concealment Holsters

566/567/568/569 CUSTOM FIT HOLSTERS FOR: PISTOLS (continued)

How to Order	Duty Holsters	GUN DESCRIPTION	FINISH	COLOR	566		567		568		569	
					RIGHT	LEFT	RIGHT	LEFT	RIGHT	LEFT	RIGHT	LEFT
Duty Accessories		Browning Hi-Power 9mm, 4.625" BBL BDM 9mm, 4.73" BBL	STX Plain	Black	566-53-411	566-53-412	567-53-411	567-53-412	568-53-411	568-53-412	569-53-411	569-53-412
Tactical Holsters		Colt Combat Elite, Delta Elite, Delta Gold Cup, Gold Cup Nat'l Match, Government 1911 5" BBL	STX Plain	Black	566-53-411	566-53-412	567-53-411	567-53-412	568-53-411	568-53-412	569-53-411	569-53-412
Tactical Accessories		Colt Commander 4.25" BBL	STX Plain	Black	566-51-411	566-51-412	567-51-411	567-51-412	568-51-411	568-51-412	569-51-411	569-51-412
Duty Belts		Colt Officers' .45ACP 3.5" BBL	STX Plain	Black	566-54-411	566-54-412	567-54-411	567-54-412	568-54-411	568-54-412	569-54-411	569-54-412
OAS		CZ 75, 85 4.5" BBL	STX Plain	Black	566-51-411	566-51-412	567-51-411	567-51-412	568-51-411	568-51-412	569-51-411	569-51-412
Speed Loaders		EAA Witness 4.5" BBL	STX Plain	Black	566-51-411	566-51-412	567-51-411	567-51-412	568-51-411	568-51-412	569-51-411	569-51-412
Light Systems		FN FNP 9mm, .45 FNX 9mm, .40 4.5" BBL	STX Plain	Black	566-744-411	566-744-412	567-744-411	567-744-412	568-744-411	568-744-412	569-744-411	569-744-412
Concealment Holsters		Glock 17, 22 4.5" BBL 20, 21 4.6" BBL 30S, 38 4" BBL	STX Plain	Black	566-83-411	566-83-412	567-83-411	567-83-412	568-83-411	568-83-412	569-83-411	569-83-412
Concealment Accessories		Glock 19, 23 4" BBL 26, 27 3.5" BBL 36 3.75"	STX Plain	Black	566-54-411	566-54-412	567-54-411	567-54-412	568-54-411	568-54-412	569-54-411	569-54-412
Competition		Glock 34, 35 5.32" BBL 37 4.5" BBL 21SF w/ Picatinny Rails 4.6" BBL	STX Plain	Black	566-49-411	566-49-412	567-49-411	567-49-412	568-49-411	568-49-412	569-49-411	569-49-412
Apparel		Glock 39 3.46" BBL	STX Plain	Black	566-744-411	566-744-412	567-744-411	567-744-412	568-744-411	568-744-412	569-744-411	569-744-412
Sales Support		Glock 41 5.31" BBL	STX Plain	Black	566-49-411	566-49-412	567-49-411	567-49-412	568-49-411	568-49-412	569-49-411	569-49-412
Index/Price List		Heckler & Koch USP 9C, 40C 3.58" BBL	STX Plain	Black	566-54-411	566-54-412	567-54-411	567-54-412	568-54-411	568-54-412	569-54-411	569-54-412
		Heckler & Koch USP 9mm, .40 4.1" BBL USP 45 4.41" BBL	STX Plain	Black	566-744-411	566-744-412	567-744-411	567-744-412	568-744-411	568-744-412	569-744-411	569-744-412

Concealment Holsters

566/567/568/569 CUSTOM FIT HOLSTERS FOR: PISTOLS (continued)

GUN DESCRIPTION	FINISH	COLOR	566		567		568		569	
			RIGHT	LEFT	RIGHT	LEFT	RIGHT	LEFT	RIGHT	LEFT
Heckler & Koch USP Expert .45 4.41" BBL	STX Plain	Black	566-49-411	566-49-412	567-49-411	567-49-412	568-49-411	568-49-412	569-49-411	569-49-412
Kahr K9 4" BBL	STX Plain	Black	566-54-411	566-54-412	567-54-411	567-54-412	568-54-411	568-54-412	569-54-411	569-54-412
Kimber KIP45CUS 5" BBL	STX Plain	Black	566-53-411	566-53-412	567-53-411	567-53-412	568-53-411	568-53-412	569-53-411	569-53-412
Para-Ordnance P14 5" BBL	STX Plain	Black	566-53-411	566-53-412	567-53-411	567-53-412	568-53-411	568-53-412	569-53-411	569-53-412
Ruger KP-89, KP-89 DC, KP-89 DW, KP-89 DAO, KP-89 DAOW, KP-89 W, P-85, P-89, P-89 DC, P-89 W, P-89 DW, 4.5" BBL	STX Plain	Black	566-83-411	566-83-412	567-83-411	567-83-412	568-83-411	568-83-412	569-83-411	569-83-412
Ruger KP-90, KP-91 DC, P90 45, P91 4.5" BBL	STX Plain	Black	566-49-411	566-49-412	567-49-411	567-49-412	568-49-411	568-49-412	569-49-411	569-49-412
Ruger SR9 4" BBL	STX Plain	Black	566-54-411	566-54-412	567-54-411	567-54-412	568-54-411	568-54-412	569-54-411	569-54-412
Ruger SR9c 3.4" BBL	STX Plain	Black	566-54-411	566-54-412	567-54-411	567-54-412	568-54-411	568-54-412	569-54-411	569-54-412
Sig Sauer P225, P228 3.9" BBL P239 3.625" BBL P229 3.9" BBL	STX Plain	Black	566-54-411	566-54-412	567-54-411	567-54-412	568-54-411	568-54-412	569-54-411	569-54-412
Sig Sauer P226R MK25 4.41" BBL	STX Plain	Black	566-49-411	566-49-412	567-49-411	567-49-412	568-49-411	568-49-412	569-49-411	569-49-412
Sig Sauer P227 4.4" BBL	STX Plain	Black	566-49-411	566-49-412	567-49-411	567-49-412	568-49-411	568-49-412	569-49-411	569-49-412
Sig Sauer P220, P226, Old Style P220, P226, New Style P226 DA 4.41" BBL	STX Plain	Black	566-83-411	566-83-412	567-83-411	567-83-412	568-83-411	568-83-412	569-83-411	569-83-412
Sig Sauer P226R DA/SA DAK Bobbed or Spurred Hammer 4.41" BBL	STX Plain	Black	566-49-411	566-49-412	567-49-411	567-49-412	568-49-411	568-49-412	569-49-411	569-49-412
Sig Sauer P226R Elite 4.41" BBL	STX Plain	Black	566-49-411	566-49-412	567-49-411	567-49-412	568-49-411	568-49-412	569-49-411	569-49-412
Sig Sauer P229R DA/SA DAK 3.9" BBL P220R Compact 3.75" BBL	STX Plain	Black	566-744-411	566-744-412	567-744-411	567-744-412	568-744-411	568-744-412	569-744-411	569-744-412

How to Order
Duty Holsters
Duty Accessories
Tactical Holsters
Tactical Accessories
Duty Belts
QAS
Speed Loaders
Light Systems
Concealment Holsters
Concealment Accessories
Competition
Apparel
Sales Support
Index/Price List

Concealment Holsters

566/567/568/569 CUSTOM FIT HOLSTERS FOR: PISTOLS (continued)

How to Order	Duty Holsters	GUN DESCRIPTION	FINISH	COLOR	566		567		568		569	
					RIGHT	LEFT	RIGHT	LEFT	RIGHT	LEFT	RIGHT	LEFT
Duty Accessories		Sig Sauer P320 4.7" BBL	STX Plain	Black	566-49-411	566-49-412	567-49-411	567-49-412	568-49-411	568-49-412	569-49-411	569-49-412
Duty Accessories		Sig Sauer P320C 3.9" BBL	STX Plain	Black	566-744-411	566-744-412	567-744-411	567-744-412	568-744-411	568-744-412	569-744-411	569-744-412
Tactical Holsters		Smith & Wesson 645, 1006, 1026, 1046, 4506, 4506-1, 4526, 4546 5" BBL	STX Plain	Black	566-53-411	566-53-412	567-53-411	567-53-412	568-53-411	568-53-412	569-53-411	569-53-412
Tactical Accessories		Smith & Wesson 469, 669, 908, 3913, 3913TSW, 3914, 3953, 3954, 4013, 4013TSW, 4053, 4053TSW, 4056TSW, 4513TSW, 6904, 6906, 6924, 6926, 6944, 6946, Short Trigger Guard, 6906, 6946 Lg Trigger Guard 3.5" BBL 4516-1 Ver. II, 4516-2, 4536, 4556, 3.75" BBL CS9 3" BBL	STX Plain	Black	566-54-411	566-54-412	567-54-411	567-54-412	568-54-411	568-54-412	569-54-411	569-54-412
Duty Belts		Smith & Wesson 39, 59, 410, 411, 439, 457, 459, 639, 659, 909, 910, 915, 3904, 3906, 4006, 4026, 4046, 5903, 5904, 5923, 5924, 5926, Sigma 40C, 5906, 5943, 5944, 5946, Short Trigger Guard, 9C, 40V, 9V, 5906, 5946 Lg Trigger Guard 4" BBL 1066, 1076, 1086, 4566, 4576, 4586 4.25" BBL Sigma 9mm, .40 4.5" BBL	STX Plain	Black	566-83-411	566-83-412	567-83-411	567-83-412	568-83-411	568-83-412	569-83-411	569-83-412
Speed Loaders		Smith & Wesson M&P 9mm, .40, .45 w/ & w/o Manual Thumb Safety 4.25" BBL	STX Plain	Black	566-83-411	566-83-412	567-83-411	567-83-412	568-83-411	568-83-412	569-83-411	569-83-412
Light Systems		Smith & Wesson M&P SHIELD 9mm 3.1" BBL	STX Plain	Black	566-54-411	566-54-412	567-54-411	567-54-412	568-54-411	568-54-412	569-54-411	569-54-412
Concealment Holsters		Sphinx 3000 4.5" BBL	STX Plain	Black	566-49-411	566-49-412	567-49-411	567-49-412	568-49-411	568-49-412	569-49-411	569-49-412
Concealment Accessories		Springfield Armory XD 9mm, .40, .357, .45 4" BBL	STX Plain	Black	566-744-411	566-744-412	567-744-411	567-744-412	568-744-411	568-744-412	569-744-411	569-744-412
Competition		Springfield Armory XD 9mm, .40, .357, .45 5" BBL	STX Plain	Black	566-49-411	566-49-412	567-49-411	567-49-412	568-49-411	568-49-412	569-49-411	569-49-412
Apparel		Springfield Armory XD(M) .40, .45 4.5" BBL	STX Plain	Black	566-49-411	566-49-412	567-49-411	567-49-412	568-49-411	568-49-412	569-49-411	569-49-412
Sales Support		Springfield Armory 1911-A1 5" BBL	STX Plain	Black	566-53-411	566-53-412	567-53-411	567-53-412	568-53-411	568-53-412	569-53-411	569-53-412
Index/Price List												

Concealment Holsters

566/567/568/569 CUSTOM FIT HOLSTERS FOR: PISTOLS (continued)

GUN DESCRIPTION	FINISH	COLOR	566		567		568		569	
			RIGHT	LEFT	RIGHT	LEFT	RIGHT	LEFT	RIGHT	LEFT
STI GP6 4.25" BBL	STX Plain	Black	566-83-411	566-83-412	567-83-411	567-83-412	568-83-411	568-83-412	569-83-411	569-83-412
Taurus PT-92, PT-99 5" BBL	STX Plain	Black	566-53-411	566-53-412	567-53-411	567-53-412	568-53-411	568-53-412	569-53-411	569-53-412
Taurus PT-92C, PT-99C 4" BBL	STX Plain	Black	566-51-411	566-51-412	567-51-411	567-51-412	568-51-411	568-51-412	569-51-411	569-51-412
Walther P99, P-5 4" BBL	STX Plain	Black	566-54-411	566-54-412	567-54-411	567-54-412	568-54-411	568-54-412	569-54-411	569-54-412
Wilson Combat 1911 4.9" BBL	STX Plain	Black	566-53-411	566-53-412	567-53-411	567-53-412	568-53-411	568-53-412	569-53-411	569-53-412

How to Order
Duty Holsters
Duty Accessories
Tactical Holsters
Tactical Accessories
Duty Belts
QAS
Speed Loaders
Light Systems
Concealment Holsters
Concealment Accessories
Competition
Apparel
Sales Support
Index/Price List

Concealment Holsters

566/567/568/569 CUSTOM FIT HOLSTERS FOR: REVOLVERS



PATENTED

566 BELT SLIDE



PATENTED

567 BELT LOOP



PATENTED

568 PADDLE & BELT LOOP COMBO



back view



PATENTED & PATENT PENDING

569 BELT CLIP

FEATURES

- ▶ 6 pistol and 4 revolver fits accommodate over 200 different weapons
- ▶ IDPA approved
- ▶ Adjustable injection-molded belt loop fits 1.5" (38mm), 1.75" (45mm), 2" (50mm), and 2.25" (58mm) on models 567 & 568; please specify
- ▶ Belt loop is user-adjustable for cant angle; can even be worn cross draw
- ▶ Genuine SafariLaminate™ thermal-molded construction with suede lining to help protect the gun's finish
- ▶ Available in STX Plain Black finish

Model 567 is available in seven belt loop sizes:

Sample Codes:

567-09-411	1.5" Belt Slots w/ Cut-outs for 1.75" Belt Slots
567-09-411-150	1.5" Belt Slots
567-09-411-175	1.75" Belt Slots
567-09-411-50	2" Belt Slots
567-09-411-225	2.25" Belt Slots
567-09-411-DM	1.5" Belt Slots w/ Cut-outs for 1.75", 2" and 2.25" Belt Slots w/ 1" Drop
567-09-411-225DM	2.25" Belt Slots w/ 1" Drop



GUN DESCRIPTION	FINISH	COLOR	566		567		568		569	
			RIGHT	LEFT	RIGHT	LEFT	RIGHT	LEFT	RIGHT	LEFT
Colt Agent, Detective Special, DS-II, SF-VI 2" BBL	STX Plain	Black	566-01-411	566-01-412	567-01-411	567-01-412	568-01-411	568-01-412	569-01-411	569-01-412
Colt King Cobra, Python, Trooper 4" BBL	STX Plain	Black	566-09-411	566-09-412	567-09-411	567-09-412	568-09-411	568-09-412	569-09-411	569-09-412
Ruger SP101 2.25" BBL	STX Plain	Black	566-01-411	566-01-412	567-01-411	567-01-412	568-01-411	568-01-412	569-01-411	569-01-412
Ruger GP100, Security Six, Service Six, Speed Six 4.5" BBL	STX Plain	Black	566-09-411	566-09-412	567-09-411	567-09-412	568-09-411	568-09-412	569-09-411	569-09-412
Ruger LCR .38 Special 1.875" BBL	STX Plain	Black	566-01-411	566-01-412	567-01-411	567-01-412	568-01-411	568-01-412	569-01-411	569-01-412
Smith & Wesson 25, 27, 28, 29, 57, 325, 327, 329, 357, 625, 627, 629, 657 N Large Frame 4" BBL	STX Plain	Black	566-12-411	566-12-412	567-12-411	567-12-412	568-12-411	568-12-412	569-12-411	569-12-412

Concealment Holsters

566/567/568/569 CUSTOM FIT HOLSTERS FOR: REVOLVERS (continued)

GUN DESCRIPTION	FINISH	COLOR	566		567		568		569	
			RIGHT	LEFT	RIGHT	LEFT	RIGHT	LEFT	RIGHT	LEFT
Smith & Wesson 25, 27, 28, 29, 57, 325, 327, 329, 357, 625, 627, 629, 657 N Large Frame 5" BBL	STX Plain	Black	566-13-411	566-13-412	567-13-411	567-13-412	568-13-411	568-13-412	569-13-411	569-13-412
Smith & Wesson 10, 12, 13, 15, 19, 64, 65, 66, 67, 617, 648 K Medium, Frame, 581, 586, 681, 686, L Medium Frame 4" BBL	STX Plain	Black	566-09-411	566-09-412	567-09-411	567-09-412	568-09-411	568-09-412	569-09-411	569-09-412
Smith & Wesson 31, 34, 36, 36LS, 37, 60, 60LS, 38HL, 49HL, 649HL, J Small Frame 2" BBL	STX Plain	Black	566-01-411	566-01-412	567-01-411	567-01-412	568-01-411	568-01-412	569-01-411	569-01-412
Taurus M-85 2" BBL	STX Plain	Black	566-01-411	566-01-412	567-01-411	567-01-412	568-01-411	568-01-412	569-01-411	569-01-412

How to Order
Duty Holsters
Duty Accessories
Tactical Holsters
Tactical Accessories
Duty Belts
QAS
Speed Loaders
Light Systems
Concealment Holsters
Concealment Accessories
Competition
Apparel
Sales Support
Index/Price List

Concealment Holsters

575 GLS™ PRO-FIT™ INSIDE-WAISTBAND HOLSTER



FEATURES

- ▶ GLS™ (Grip Locking System) secures firearm once holstered; retention is deactivated with the middle finger upon obtaining a standard shooting grip
- ▶ Designed to fit multiple firearms in one holster
- ▶ Inside-the-waist for deep concealment
- ▶ Body is proprietary nylon blend that is non-abrasive to firearm's finish
- ▶ Low-cut compact design makes concealment easy while allowing for quick draw
- ▶ Fully adjustable cant

GUN DESCRIPTION	FINISH	COLOR	RIGHT	LEFT
FN FNS 9mm, .40 4" BBL	SafariSeven Plain	Black	575-283-411	575-283-412
FN FNS 9mm, .40 Compact 3.6" BBL	SafariSeven Plain	Black	575-283-411	575-283-412
Glock 19, 23 4" BBL	SafariSeven Plain	Black	575-283-411	575-283-412
Glock 26, 27 3.5" BBL	SafariSeven Plain	Black	575-283-411	575-283-412
Glock 30, 30S 3.7" BBL	SafariSeven Plain	Black	575-283-411	575-283-412
Heckler & Koch P30 9mm, .40 3.78" BBL	SafariSeven Plain	Black	575-283-411	575-283-412
Heckler & Koch P2000 9mm, .40 3.5" BBL	SafariSeven Plain	Black	575-283-411	575-283-412
Heckler & Koch USP 9C/40C 3.58" BBL	SafariSeven Plain	Black	575-283-411	575-283-412
Heckler & Koch VP9 4.09" BBL	SafariSeven Plain	Black	575-283-411	575-283-412
Heckler & Koch HK 45C 3.9" BBL	SafariSeven Plain	Black	575-283-411	575-283-412
Smith & Wesson M&P SHIELD 9mm/.40 3.1" BBL	SafariSeven Plain	Black	575-283-411	575-283-412
Springfield Armory XD-S 9mm, .45 3.3" BBL	SafariSeven Plain	Black	575-283-411	575-283-412
Walther P99, P99 DAO 4" BBL	SafariSeven Plain	Black	575-283-411	575-283-412
Walther P99QA 4" BBL	SafariSeven Plain	Black	575-283-411	575-283-412
Walther P99C QA 3.5" BBL	SafariSeven Plain	Black	575-283-411	575-283-412
Walther P99C DAO 3.5" BBL	SafariSeven Plain	Black	575-283-411	575-283-412
Walther PPQ 4" BBL	SafariSeven Plain	Black	575-283-411	575-283-412
Walther PPQ M2 4" BBL	SafariSeven Plain	Black	575-283-411	575-283-412
Walther PPS 4" BBL	SafariSeven Plain	Black	575-283-411	575-283-412

Concealment Holsters

576/577/578/579 GLS™ PRO-FIT™ HOLSTER: PISTOLS

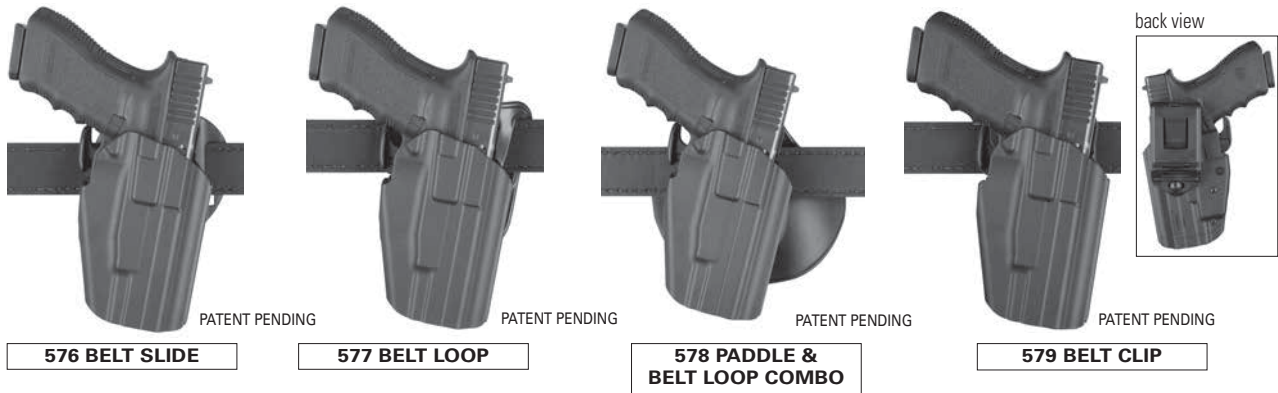

FEATURES

- ▶ GLS™ (Grip Lock System) secures weapon once holstered; retention is deactivated with the middle finger upon a standard shooting grip on the weapon
- ▶ Designed to fit multiple firearms in one holster, adjustment available to further customize fit
- ▶ Low-cut and compact design make concealment easy while also allowing for a quick draw
- ▶ Body is proprietary nylon blend that is non-abrasive to a firearm's finish, maintains very high heat tolerance, low cold tolerance
- ▶ Available in SafariSeven™ Plain Black and FDE Brown finishes

GUN DESCRIPTION	FINISH	COLOR	576		577		578		579	
			RIGHT	LEFT	RIGHT	LEFT	RIGHT	LEFT	RIGHT	LEFT
Beretta 92, 92F (M9), 92FS, 90-Two, 92A1, 92 Centurion 96, 96A1 4.9" BBL	SafariSeven Plain	Black	576-450-411	576-450-412	577-450-411	577-450-412	578-450-411	578-450-412	579-450-411	579-450-412
	SafariSeven Plain	FDE Brown	576-450-551	576-450-552	577-450-551	577-450-552	578-450-551	578-450-552	579-450-551	579-450-552
Colt 1911 & similar 5" BBL	SafariSeven Plain	Black	576-683-411	576-683-412	577-683-411	577-683-412	578-683-411	578-683-412	579-683-411	579-683-412
	SafariSeven Plain	FDE Brown	576-683-551	576-683-552	577-683-551	577-683-552	578-683-551	578-683-552	579-683-551	579-683-552
CZ 75 4.6" BBL	SafariSeven Plain	Black	576-683-411	576-683-412	577-683-411	577-683-412	578-683-411	578-683-412	579-683-411	579-683-412
	SafariSeven Plain	FDE Brown	576-683-551	576-683-552	577-683-551	577-683-552	578-683-551	578-683-552	579-683-551	579-683-552
CZ P-09 4.53" BBL	SafariSeven Plain	Black	576-450-411	576-450-412	577-450-411	577-450-412	578-450-411	578-450-412	579-450-411	579-450-412
	SafariSeven Plain	FDE Brown	576-450-551	576-450-552	577-450-551	577-450-552	578-450-551	578-450-552	579-450-551	579-450-552
FN FNS 9mm, .40 Compact 3.6" BBL	SafariSeven Plain	Black	576-183-411	576-183-412	577-183-411	577-183-412	578-183-411	578-183-412	579-183-411	579-183-412
	SafariSeven Plain	FDE Brown	576-183-551	576-183-552	577-183-551	577-183-552	578-183-551	578-183-552	579-183-551	579-183-552
FN FNS 9mm, .40 4.00" BBL	SafariSeven Plain	Black	576-283-411	576-283-412	577-283-411	577-283-412	578-283-411	578-283-412	579-283-411	579-283-412
	SafariSeven Plain	FDE Brown	576-283-551	576-283-552	577-283-551	577-283-552	578-283-551	578-283-552	579-283-551	579-283-552
FN FNS 9mm, .40 5" BBL	SafariSeven Plain	Black	576-683-411	576-683-412	577-683-411	577-683-412	578-683-411	578-683-412	579-683-411	579-683-412
	SafariSeven Plain	FDE Brown	576-683-551	576-683-552	577-683-551	577-683-552	578-683-551	578-683-552	579-683-551	579-683-552
FN Five-Seven	SafariSeven Plain	Black	576-683-411	576-683-412	577-683-411	577-683-412	578-683-411	578-683-412	579-683-411	579-683-412
	SafariSeven Plain	FDE Brown	576-683-551	576-683-552	577-683-551	577-683-552	578-683-551	578-683-552	579-683-551	579-683-552
FN FNP 45 w/ Red Dot 4" BBL	SafariSeven Plain	Black	576-450-411	576-450-412	577-450-411	577-450-412	578-450-411	578-450-412	579-450-411	579-450-412
	SafariSeven Plain	FDE Brown	576-450-551	576-450-552	577-450-551	577-450-552	578-450-551	578-450-552	579-450-551	579-450-552
Glock 17, 22 4.5" BBL	SafariSeven Plain	Black	576-83-411	576-83-412	577-83-411	577-83-412	578-83-411	578-83-412	579-83-411	579-83-412
	SafariSeven Plain	FDE Brown	576-83-551	576-83-552	577-83-551	577-83-552	578-83-551	578-83-552	579-83-551	579-83-552
Glock 17L 6.02" BBL	SafariSeven Plain	Black	576-683-411	576-683-412	577-683-411	577-683-412	578-683-411	578-683-412	579-683-411	579-683-412
	SafariSeven Plain	FDE Brown	576-683-551	576-683-552	577-683-551	577-683-552	578-683-551	578-683-552	579-683-551	579-683-552
Glock 19, 23 4" BBL	SafariSeven Plain	Black	576-283-411	576-283-412	577-283-411	577-283-412	578-283-411	578-283-412	579-283-411	579-283-412
	SafariSeven Plain	FDE Brown	576-283-551	576-283-552	577-283-551	577-283-552	578-283-551	578-283-552	579-283-551	579-283-552

How to Order
Duty Holsters
Duty Accessories
Tactical Holsters
Tactical Accessories
Duty Belts
QAS
Speed Loaders
Light Systems
Concealment Holsters
Concealment Accessories
Competition
Apparel
Sales Support
Index/Price List

Concealment Holsters

576/577/578/579 GLS™ PRO-FIT™ HOLSTER: PISTOLS (continued)

How to Order	Duty Holsters	GUN DESCRIPTION	FINISH	COLOR	576		577		578		579	
					RIGHT	LEFT	RIGHT	LEFT	RIGHT	LEFT	RIGHT	LEFT
Duty Accessories	Glock 20, 21 4.6" BBL	SafariSeven Plain	Black	576-83-411	576-83-412	577-83-411	577-83-412	578-83-411	578-83-412	579-83-411	579-83-412	
		SafariSeven Plain	FDE Brown	576-83-551	576-83-552	577-83-551	577-83-552	578-83-551	578-83-552	579-83-551	579-83-552	
Duty Accessories	Glock 26, 27 3.5" BBL	SafariSeven Plain	Black	576-183-411	576-183-412	577-183-411	577-183-412	578-183-411	578-183-412	579-183-411	579-183-412	
		SafariSeven Plain	FDE Brown	576-183-551	576-183-552	577-183-551	577-183-552	578-183-551	578-183-552	579-183-551	579-183-552	
Tactical Holsters	Glock 30, 30S 3.7" BBL	SafariSeven Plain	Black	576-183-411	576-183-412	577-183-411	577-183-412	578-183-411	578-183-412	579-183-411	579-183-412	
		SafariSeven Plain	FDE Brown	576-183-551	576-183-552	577-183-551	577-183-552	578-183-551	578-183-552	579-183-551	579-183-552	
Tactical Accessories	Glock 34, 35 5.32" BBL	SafariSeven Plain	Black	576-683-411	576-683-412	577-683-411	577-683-412	578-683-411	578-683-412	579-683-411	579-683-412	
		SafariSeven Plain	FDE Brown	576-683-551	576-683-552	577-683-551	577-683-552	578-683-551	578-683-552	579-683-551	579-683-552	
Tactical Accessories	Glock 37 4.5" BBL	SafariSeven Plain	Black	576-83-411	576-83-412	577-83-411	577-83-412	578-83-411	578-83-412	579-83-411	579-83-412	
		SafariSeven Plain	FDE Brown	576-83-551	576-83-552	577-83-551	577-83-552	578-83-551	578-83-552	579-83-551	579-83-552	
Duty Belts	Glock 38, 39 3.38" BBL	SafariSeven Plain	Black	576-283-411	576-283-412	577-283-411	577-283-412	578-283-411	578-283-412	579-283-411	579-283-412	
		SafariSeven Plain	FDE Brown	576-283-551	576-283-552	577-283-551	577-283-552	578-283-551	578-283-552	579-283-551	579-283-552	
Duty Belts	Glock 41 5.31" BBL	SafariSeven Plain	Black	576-683-411	576-683-412	577-683-411	577-683-412	578-683-411	578-683-412	579-683-411	579-683-412	
		SafariSeven Plain	FDE Brown	576-683-551	576-683-552	577-683-551	577-683-552	578-683-551	578-683-552	579-683-551	579-683-552	
Speed Loaders	Glock 43 3.39" BBL	SafariSeven	Plain	576-895-411	576-895-412	577-895-411	577-895-412	578-895-411	578-895-412	579-895-411	579-895-412	
		SafariSeven	FDE Brown	576-895-551	576-895-552	577-895-551	577-895-552	578-895-551	578-895-552	579-895-551	579-895-552	
Speed Loaders	Heckler & Koch HK 45 4.25" BBL	SafariSeven Plain	Black	576-83-411	576-83-412	577-83-411	577-83-412	578-83-411	578-83-412	579-83-411	579-83-412	
		SafariSeven Plain	FDE Brown	576-83-551	576-83-552	577-83-551	577-83-552	578-83-551	578-83-552	579-83-551	579-83-552	
Light Systems	Heckler & Koch P30 9mm, .40 3.78" BBL	SafariSeven Plain	Black	576-283-411	576-283-412	577-283-411	577-283-412	578-283-411	578-283-412	579-283-411	579-283-412	
		SafariSeven Plain	FDE Brown	576-283-551	576-283-552	577-283-551	577-283-552	578-283-551	578-283-552	579-283-551	579-283-552	
Light Systems	Heckler & Koch P30L 9mm, .40 4.45" BBL	SafariSeven Plain	Black	576-83-411	576-83-412	577-83-411	577-83-412	578-83-411	578-83-412	579-83-411	579-83-412	
		SafariSeven Plain	FDE Brown	576-83-551	576-83-552	577-83-551	577-83-552	578-83-551	578-83-552	579-83-551	579-83-552	
Concealment Holsters	Heckler & Koch P2000 9mm, .40 3.5" BBL	SafariSeven Plain	Black	576-183-411	576-183-412	577-183-411	577-183-412	578-183-411	578-183-412	579-183-411	579-183-412	
		SafariSeven Plain	FDE Brown	576-183-551	576-183-552	577-183-551	577-183-552	578-183-551	578-183-552	579-183-551	579-183-552	
Concealment Holsters	Heckler & Koch P2000SK 9mm, .40 3.5" BBL	SafariSeven Plain	Black	576-183-411	576-183-412	577-183-411	577-183-412	578-183-411	578-183-412	579-183-411	579-183-412	
		SafariSeven Plain	FDE Brown	576-183-551	576-183-552	577-183-551	577-183-552	578-183-551	578-183-552	579-183-551	579-183-552	
Concealment Accessories	Heckler & Koch USP 9/40 4.25" BBL	SafariSeven Plain	Black	576-283-411	576-283-412	577-283-411	577-283-412	578-283-411	578-283-412	579-283-411	579-283-412	
		SafariSeven Plain	FDE Brown	576-283-551	576-283-552	577-283-551	577-283-552	578-283-551	578-283-552	579-283-551	579-283-552	
Concealment Accessories	Heckler & Koch USP 9C/40C 3.58" BBL	SafariSeven Plain	Black	576-283-411	576-283-412	577-283-411	577-283-412	578-283-411	578-283-412	579-283-411	579-283-412	
		SafariSeven Plain	FDE Brown	576-283-551	576-283-552	577-283-551	577-283-552	578-283-551	578-283-552	579-283-551	579-283-552	
Competition	Heckler & Koch VP9 4.09" BBL	SafariSeven Plain	Black	576-283-411	576-283-412	577-283-411	577-283-412	578-283-411	578-283-412	579-283-411	579-283-412	
		SafariSeven Plain	FDE Brown	576-283-551	576-283-552	577-283-551	577-283-552	578-283-551	578-283-552	579-283-551	579-283-552	
Apparel	Heckler & Koch HK 45C 3.9" BBL	SafariSeven Plain	Black	576-283-411	576-283-412	577-283-411	577-283-412	578-283-411	578-283-412	579-283-411	579-283-412	
		SafariSeven Plain	FDE Brown	576-283-551	576-283-552	577-283-551	577-283-552	578-283-551	578-283-552	579-283-551	579-283-552	
Sales Support	Kimber 1911s & Similar 5" BBL	SafariSeven Plain	Black	576-683-411	576-683-412	577-683-411	577-683-412	578-683-411	578-683-412	579-683-411	579-683-412	
		SafariSeven Plain	FDE Brown	576-683-551	576-683-552	577-683-551	577-683-552	578-683-551	578-683-552	579-683-551	579-683-552	
Index/Price List	Ruger American 9mm, .40 4.5" BBL	SafariSeven Plain	Black	576-83-411	576-83-412	577-83-411	577-83-412	578-83-411	578-83-412	579-83-411	579-83-412	
		SafariSeven Plain	FDE Brown	576-83-551	576-83-552	577-83-551	577-83-552	578-83-551	578-83-552	579-83-551	579-83-552	
Index/Price List	Ruger American .45 4.5" BBL	SafariSeven Plain	Black	576-683-411	576-683-412	577-683-411	577-683-412	578-683-411	578-683-412	579-683-411	579-683-412	
		SafariSeven Plain	FDE Brown	576-683-551	576-683-552	577-683-551	577-683-552	578-683-551	578-683-552	579-683-551	579-683-552	

Concealment Holsters

576/577/578/579 GLS™ PRO-FIT™ HOLSTER: PISTOLS (continued)

GUN DESCRIPTION	FINISH	COLOR	576		577		578		579	
			RIGHT	LEFT	RIGHT	LEFT	RIGHT	LEFT	RIGHT	LEFT
Sig Sauer 1911 & Similar 5" BBL	SafariSeven Plain	Black	576-683-411	576-683-412	577-683-411	577-683-412	578-683-411	578-683-412	579-683-411	579-683-412
			576-683-551	576-683-552	577-683-551	577-683-552	578-683-551	578-683-552	579-683-551	579-683-552
Sig Sauer P220, P220R, P226, P226R 4.41" BBL	SafariSeven Plain	Black	576-450-411	576-450-412	577-450-411	577-450-412	578-450-411	578-450-412	579-450-411	579-450-412
			576-450-551	576-450-552	577-450-551	577-450-552	578-450-551	578-450-552	579-450-551	579-450-552
Sig Sauer P229, P229R 3.9" BBL	SafariSeven Plain	Black	576-750-411	576-750-412	577-750-411	577-750-412	578-750-411	578-750-412	579-750-411	579-750-412
			576-750-551	576-750-552	577-750-551	577-750-552	578-750-551	578-750-552	579-750-551	579-750-552
Sig Sauer P320 9mm, .40, .45 3.9" BBL	SafariSeven Plain	Black	576-750-411	576-750-412	577-750-411	577-750-412	578-750-411	578-750-412	579-750-411	579-750-412
			576-750-551	576-750-552	577-750-551	577-750-552	578-750-551	578-750-552	579-750-551	579-750-552
Sig Sauer P320 9mm, .40, .45 4.7" BBL	SafariSeven Plain	Black	576-450-411	576-450-412	577-450-411	577-450-412	578-450-411	578-450-412	579-450-411	579-450-412
			576-450-551	576-450-552	577-450-551	577-450-552	578-450-551	578-450-552	579-450-551	579-450-552
Smith & Wesson 5906TSW 4.00" BBL	SafariSeven Plain	Black	576-283-411	576-283-412	577-283-411	577-283-412	578-283-411	578-283-412	579-283-411	579-283-412
			576-283-551	576-283-552	577-283-551	577-283-552	578-283-551	578-283-552	579-283-551	579-283-552
Smith & Wesson M&P .22, 9mm, .40, .45 4.25" BBL	SafariSeven Plain	Black	576-83-411	576-83-412	577-83-411	577-83-412	578-83-411	578-83-412	579-83-411	579-83-412
			576-83-551	576-83-552	577-83-551	577-83-552	578-83-551	578-83-552	579-83-551	579-83-552
Smith & Wesson M&P Shield 9mm, .40, .45 3.1" BBL	SafariSeven Plain	Black	576-895-411	576-895-412	577-895-411	577-895-412	578-895-411	578-895-412	579-895-411	579-895-412
			576-895-551	576-895-552	577-895-551	577-895-552	578-895-551	578-895-552	579-895-551	579-895-552
Smith & Wesson M&P 9mm, .40 CORE 4.25" BBL	SafariSeven Plain	Black	576-83-411	576-83-412	577-83-411	577-83-412	578-83-411	578-83-412	579-83-411	579-83-412
			576-83-551	576-83-552	577-83-551	577-83-552	578-83-551	578-83-552	579-83-551	579-83-552
Smith & Wesson M&P 9mm, .40, .45 3.38" BBL	SafariSeven Plain	Black	576-183-411	576-183-412	577-183-411	577-183-412	578-183-411	578-183-412	579-183-411	579-183-412
			576-183-551	576-183-552	577-183-551	577-183-552	578-183-551	578-183-552	579-183-551	579-183-552
Smith & Wesson M&P 9L, 40L 5" BBL	SafariSeven Plain	Black	576-683-411	576-683-412	577-683-411	577-683-412	578-683-411	578-683-412	579-683-411	579-683-412
			576-683-551	576-683-552	577-683-551	577-683-552	578-683-551	578-683-552	579-683-551	579-683-552
Smith & Wesson M&P 9L, 40L CORE 5" BBL	SafariSeven Plain	Black	576-683-411	576-683-412	577-683-411	577-683-412	578-683-411	578-683-412	579-683-411	579-683-412
			576-683-551	576-683-552	577-683-551	577-683-552	578-683-551	578-683-552	579-683-551	579-683-552
Smith & Wesson SW99 4.00" BBL	SafariSeven Plain	Black	576-283-411	576-283-412	577-283-411	577-283-412	578-283-411	578-283-412	579-283-411	579-283-412
			576-283-551	576-283-552	577-283-551	577-283-552	578-283-551	578-283-552	579-283-551	579-283-552
Springfield Armory XD-S 9mm, .45 3.3" BBL	SafariSeven Plain	Black	576-183-411	576-183-412	577-183-411	577-183-412	578-183-411	578-183-412	579-183-411	579-183-412
			576-183-551	576-183-552	577-183-551	577-183-552	578-183-551	578-183-552	579-183-551	579-183-552
Springfield Armory XD 9mm, .40, .45 4" BBL	SafariSeven Plain	Black	576-750-411	576-750-412	577-750-411	577-750-412	578-750-411	578-750-412	579-750-411	579-750-412
			576-750-551	576-750-552	577-750-551	577-750-552	578-750-551	578-750-552	579-750-551	579-750-552
Springfield Armory XD 9mm, .40, .45 5" BBL	SafariSeven Plain	Black	576-450-411	576-450-412	577-450-411	577-450-412	578-450-411	578-450-412	579-450-411	579-450-412
			576-450-551	576-450-552	577-450-551	577-450-552	578-450-551	578-450-552	579-450-551	579-450-552
Springfield Armory XDM 9mm, .40, .45 4.5" BBL	SafariSeven Plain	Black	576-450-411	576-450-412	577-450-411	577-450-412	578-450-411	578-450-412	579-450-411	579-450-412
			576-450-551	576-450-552	577-450-551	577-450-552	578-450-551	578-450-552	579-450-551	579-450-552
Springfield Armory XDM 9mm, .40, .45 5.25" BBL	SafariSeven Plain	Black	576-450-411	576-450-412	577-450-411	577-450-412	578-450-411	578-450-412	579-450-411	579-450-412
			576-450-551	576-450-552	577-450-551	577-450-552	578-450-551	578-450-552	579-450-551	579-450-552
Springfield Armory 1911s 5" BBL	SafariSeven Plain	Black	576-683-411	576-683-412	577-683-411	577-683-412	578-683-411	578-683-412	579-683-411	579-683-412
			576-683-551	576-683-552	577-683-551	577-683-552	578-683-551	578-683-552	579-683-551	579-683-552
Springfield Armory XD-S 9mm, .40 3.3" BBL	SafariSeven Plain	Black	576-179-411	576-179-412	577-179-411	577-179-412	578-179-411	578-179-412	579-179-411	579-179-412
			576-179-551	576-179-552	577-179-551	577-179-552	578-179-551	578-179-552	579-179-551	579-179-552
Taurus 1911s 5" BBL	SafariSeven Plain	Black	576-683-411	576-683-412	577-683-411	577-683-412	578-683-411	578-683-412	579-683-411	579-683-412
			576-683-551	576-683-552	577-683-551	577-683-552	578-683-551	578-683-552	579-683-551	579-683-552

How to Order
Duty Holsters
Duty Accessories
Tactical Holsters
Tactical Accessories
Duty Bats
QAS
Speed Loaders
Light Systems
Concealment Holsters
Concealment Accessories
Competition
Apparel
Sales Support
Index/Price List

Concealment Holsters

576/577/578/579 GLS™ PRO-FIT™ HOLSTER: PISTOLS (continued)

GUN DESCRIPTION	FINISH	COLOR	576		577		578		579	
			RIGHT	LEFT	RIGHT	LEFT	RIGHT	LEFT	RIGHT	LEFT
Taurus PT809, PT840, PT845 4" BBL	SafariSeven Plain	Black	576-83-411	576-83-412	577-83-411	577-83-412	578-83-411	578-83-412	579-83-411	579-83-412
	SafariSeven Plain	FDE Brown	576-83-551	576-83-552	577-83-551	577-83-552	578-83-551	578-83-552	579-83-551	579-83-552
Walther P99, P99 DAO 4" BBL	SafariSeven Plain	Black	576-283-411	576-283-412	577-283-411	577-283-412	578-283-411	578-283-412	579-283-411	579-283-412
	SafariSeven Plain	FDE Brown	576-283-551	576-283-552	577-283-551	577-283-552	578-283-551	578-283-552	579-283-551	579-283-552
Walther P99QA 4" BBL	SafariSeven Plain	Black	576-283-411	576-283-412	577-283-411	577-283-412	578-283-411	578-283-412	579-283-411	579-283-412
	SafariSeven Plain	FDE Brown	576-283-551	576-283-552	577-283-551	577-283-552	578-283-551	578-283-552	579-283-551	579-283-552
Walther P99C QA 3.5" BBL	SafariSeven Plain	Black	576-183-411	576-183-412	577-183-411	577-183-412	578-183-411	578-183-412	579-183-411	579-183-412
	SafariSeven Plain	FDE Brown	576-183-551	576-183-552	577-183-551	577-183-552	578-183-551	578-183-552	579-183-551	579-183-552
Walther P99C DAO 3.5" BBL	SafariSeven Plain	Black	576-183-411	576-183-412	577-183-411	577-183-412	578-183-411	578-183-412	579-183-411	579-183-412
	SafariSeven Plain	FDE Brown	576-183-551	576-183-552	577-183-551	577-183-552	578-183-551	578-183-552	579-183-551	579-183-552
Walther PPQ 4" BBL	SafariSeven Plain	Black	576-283-411	576-283-412	577-283-411	577-283-412	578-283-411	578-283-412	579-283-411	579-283-412
	SafariSeven Plain	FDE Brown	576-283-551	576-283-552	577-283-551	577-283-552	578-283-551	578-283-552	579-283-551	579-283-552
Walther PPQ M2 4" BBL	SafariSeven Plain	Black	576-283-411	576-283-412	577-283-411	577-283-412	578-283-411	578-283-412	579-283-411	579-283-412
	SafariSeven Plain	FDE Brown	576-283-551	576-283-552	577-283-551	577-283-552	578-283-551	578-283-552	579-283-551	579-283-552
Walther PPQ 5" BBL	SafariSeven Plain	Black	576-683-411	576-683-412	577-683-411	577-683-412	578-683-411	578-683-412	579-683-411	579-683-412
	SafariSeven Plain	FDE Brown	576-683-551	576-683-552	577-683-551	577-683-552	578-683-551	578-683-552	579-683-551	579-683-552
Walther PPQ M2 5" BBL	SafariSeven Plain	Black	576-683-411	576-683-412	577-683-411	577-683-412	578-683-411	578-683-412	579-683-411	579-683-412
	SafariSeven Plain	FDE Brown	576-683-551	576-683-552	577-683-551	577-683-552	578-683-551	578-683-552	579-683-551	579-683-552
Walther PPS 4" BBL	SafariSeven Plain	Black	576-283-411	576-283-412	577-283-411	577-283-412	578-283-411	578-283-412	579-283-411	579-283-412
	SafariSeven Plain	FDE Brown	576-283-551	576-283-552	577-283-551	577-283-552	578-283-551	578-283-552	579-283-551	579-283-552
Walther PPS M2 3.18" BBL	SafariSeven Plain	Black	576-179-411	576-179-412	577-179-411	577-179-412	578-179-411	578-179-412	579-179-411	579-179-412
	SafariSeven Plain	Black	576-179-551	576-179-552	577-179-551	577-179-552	578-179-551	578-179-552	579-179-551	579-179-552
Walther PPX 9mm 4" BBL	SafariSeven Plain	Black	576-750-411	576-750-412	577-750-411	577-750-412	578-750-411	578-750-412	579-750-411	579-750-412
	SafariSeven Plain	FDE Brown	576-750-551	576-750-552	577-750-551	577-750-552	578-750-551	578-750-552	579-750-551	579-750-552

Concealment Holsters

1051 ALS® SHOULDER HOLSTER FOR: PISTOLS

FEATURES

- ▶ ALS® (Automatic Locking System) secures weapon once holstered
- ▶ SafariLaminate™ thermal-molded construction for ease of draw and reholstering with one hand
- ▶ Vertical or horizontal carry options
- ▶ Dual magazine pouch included
- ▶ Harness system is comfortable and fully adjustable
- ▶ For pistols only
- ▶ Available in STX Plain Black finish



PATENTED

GUN DESCRIPTION	FINISH	COLOR	RIGHT	LEFT
Glock 17, 22 4.5" BBL	Plain	Black	1051-83-411	1051-83-412
Glock 17, 17C, 22, 22C 4.5" BBL 19, 19C, 23, 23C 4" BBL 26, 27 3.5" BBL 34, 35 5.3" BBL	Plain	Black	1051-283-411	1051-283-412
Glock 20, 21 4.6" BBL	Plain	Black	1051-383-411	1051-383-412
Glock 29, 30 3.78" BBL	Plain	Black	1051-483-411	1051-483-412
Heckler & Koch P2000 3.5" BBL	Plain	Black	1051-97-411	1051-97-412
Sig Sauer P220, P226 4.41" BBL	Plain	Black	1051-77-411	1051-77-412
Sig Sauer P220R DAK, P226R DAK, w/ Bobbed Hammer; P220R DA/SA, P226R DA/SA w/ Full Size Hammer 4.41" BBL	Plain	Black	1051-774-411	1051-774-412
Sig Sauer P225 3.86" BBL	Plain	Black	1051-79-411	1051-79-412
Sig Sauer P228, P229 3.9" BBL	Plain	Black	1051-74-411	1051-74-412
Sig Sauer P229R DAK w/ Bobbed Hammer; P229R DA/SA w/ Full Size Hammer 3.9" BBL	Plain	Black	1051-744-411	1051-744-412
Smith & Wesson M&P 9mm, .40 4.25" BBL	Plain	Black	1051-219-411	1051-219-412
Smith & Wesson SW99 4" BBL	Plain	Black	1051-84-411	1051-84-412
Walther P99 4" BBL	Plain	Black	1051-84-411	1051-84-412
Walther P99C QA 3.375" BBL	Plain	Black	1051-84-411	1051-84-412

Concealment Holsters

1053 ALS® UNIVERSAL SHOULDER HOLSTER FOR: PISTOLS



FEATURES

- ▶ ALS® (Automatic Locking System) secures weapon once holstered
- ▶ Adjustable strap to fit most body types
- ▶ Lightweight elastic single side harness provides stability for handgun
- ▶ Harness and mounting system sold separately and can be used with any ALS concealment holster (excluding revolvers)

GUN DESCRIPTION	FINISH	COLOR	RIGHT	LEFT
Beretta 92, 92F, 92FS, 92D 4.9" BBL	STX Plain	Black	1053-73-411	1053-73-412
Beretta Px4 Storm 9mm, .40 4" BBL	STX Plain	Black	1053-180-411	1053-180-412
Beretta Px4 Storm .45 m 4" BBL	STX Plain	Black	1053-185-411	1053-185-412
Colt Government 1911 5" BBL	STX Plain	Black	1053-53-411	1053-53-412
FN FNS .40 4" BBL	STX Plain	Black	1053-53-411	1053-53-412
Glock 17, 22 4.5" BBL	STX Plain	Black	1053-83-411	1053-83-412
Glock 17 & 22, ITI M3, TLR-1, SureFire X200/X300 4.5" BBL	STX Plain	Black	1053-832-411	1053-832-412
Glock 19, 23 4" BBL	STX Plain	Black	1053-283-411	1053-283-412
Glock 20, 21 4.6" BBL	STX Plain	Black	1053-383-411	1053-383-412
Glock 20, 21 w/ ITI M3, TLR-1, SureFire X200/X300 4.6" BBL	STX Plain	Black	1053-3832-411	1053-3832-412
Glock 26, 27 3.5" BBL	STX Plain	Black	1053-183-411	1053-183-412
Glock 29, 30 3.78" BBL	STX Plain	Black	1053-483-411	1053-483-412
Glock 34, 35 5.32" BBL	STX Plain	Black	1053-683-411	1053-683-412
Glock 34, 35 w/ ITI M3, TLR-1, SureFire X200/X300 4.6" BBL	STX Plain	Black	1053-6832-411	1053-6832-412
Glock 37 4.5" BBL	STX Plain	Black	1053-783-411	1053-783-412
Glock 39 4.5" BBL	STX Plain	Black	1053-883-411	1053-883-412

Concealment Holsters

1053 ALS® UNIVERSAL SHOULDER HOLSTER FOR: PISTOLS (continued)

GUN DESCRIPTION	FINISH	COLOR	RIGHT	LEFT
Heckler & Koch USP 9mm, .40 4.13" BBL	STX Plain	Black	1053-91-411	1053-91-412
Heckler & Koch USP 9C, 40C 3.58" BBL	STX Plain	Black	1053-291-411	1053-291-412
Heckler & Koch P30 3.875" BBL Heckler & Koch	STX Plain	Black	1053-295-411	1053-295-412
P30L 4.45" BBL	STX Plain	Black	1053-395-411	1053-395-412
Heckler & Koch P2000 3.5" BBL	STX Plain	Black	1053-97-411	1053-97-412
Kimber 1911 Pro Carry 4" BBL	STX Plain	Black	1053-52-411	1053-52-412
Sig Sauer P220, P226 4.41" BBL	STX Plain	Black	1053-77-411	1053-77-412
Sig Sauer P220R, P226R DAK with Bobbed Hammer P220R, P226R DASA with Full Size Hammer P226R MK25 4.41" BBL	STX Plain	Black	1053-477-411	1053-477-412
Sig Sauer P226R Elite 4.41" BBL	STX Plain	Black	1053-477-411	1053-477-412
Sig Sauer P225 3.86" BBL	STX Plain	Black	1053-79-411	1053-79-412
Sig Sauer P228, P229 3.9" BBL	STX Plain	Black	1053-74-411	1053-74-412
Sig Sauer P229R DAK with Bobber Hammer .40, P229R DA/SA with Full Size Hammer .40 3.9" BBL	STX Plain	Black	1053-447-411	1053-447-412
Sig Sauer Sig Pro 2022 3.5" BBL	STX Plain	Black	1053-278-411	1053-278-412
Sig Sauer P239 9mm 3.6" BBL	STX Plain	Black	1053-75-411	1053-75-412
Sig Sauer P239 9mm 3.6" BBL	STX Plain	Black	1053-754-411	1053-754-412
Sig Sauer P250 9mm, .40, .45 4.7" BBL	STX Plain	Black	1053-45-411	1053-450-412
Sig Sauer P250 Compact 9mm, .40, .45 3.88" BBL	STX Plain	Black	1053-750-411	1053-750-412

How to Order
Duty Holsters
Duty Accessories
Tactical Holsters
Tactical Accessories
Duty Belts
QAS
Speed Loaders
Light Systems
Concealment Holsters
Concealment Accessories
Competition
Apparel
Sales Support
Index/ Price List

Concealment Holsters

1053 ALS® UNIVERSAL SHOULDER HOLSTER FOR: PISTOLS (continued)

GUN DESCRIPTION	FINISH	COLOR	RIGHT	LEFT
Springfield Armory XD 9mm, .40, .357, .45 5" BBL	STX Plain	Black	1053-149-411	1053-149-412
Springfield Armory XD(M) 9mm 4.5" BBL	STX Plain	Black	1053-145-411	1053-145-412
Springfield Armory XD(M), .40 4.5" BBL	STX Plain	Black	1053-146-411	1053-146-412
Springfield Armory Operator 1911-A1 With Picatinny Rails 5" BBL	STX Plain	Black	1053-56-411	1053-56-412
Springfield Armory Operator 1911-A1 With Picatinny Rails 5" BBL	STX Plain	Black	1053-56-411	1053-56-412
Walther P99, P99C QA 3.375" BBL	STX Plain	Black	1053-84-411	1053-84-412
Harness Only			1053CON-KIT-411	1053CON-KIT-412

How to Order
Duty Holsters
Duty Accessories
Tactical Holsters
Tactical Accessories
Duty Belts
QAS
Speed Loaders
Light Systems
Concealment Holsters
Concealment Accessories
Competition
Apparel
Sales Support
Index/Price List

Concealment Holsters

5186/5188 CONCEALMENT HOLSTERS FOR: PISTOLS W/ LIGHTS



5186 BELT SLIDE



5188 PADDLE & BELT LOOP COMBO

FEATURES

- ▶ Specifically for light mounted weapons
- ▶ Compact and lightweight
- ▶ Genuine SafariLaminate™ construction
- ▶ Low cut sides for ease of draw and added comfort
- ▶ Injection-molded paddle designed for enhanced concealability and on model 5188
- ▶ Adjustable injection-molded belt loop fits 1.5" (38mm), 1.75" (45mm) 2" (50mm) and 2.25" (58mm) 5188 only; please specify
- ▶ Belt loop is user-adjustable for cant angle; can even be worn cross draw
- ▶ IDPA approved
- ▶ Available in STX finishes

*Available in these additional finishes:
 Sample Code 5188-83-481
 STX Basket 5188-XX-48X
 STX Hi Gloss 5188-XX-49X
 STX Foliage Green 5188-XX-54X
 STX Coyote Brown 5188-XX-76X
 STX OD Green 5188-XX-56X
 STX FDE Brown 5188-XX-55X

GUN DESCRIPTION	FINISH*	COLOR	5186		5188	
			RIGHT	LEFT	RIGHT	LEFT
Beretta 92 Vertec, 96 Vertec w/ ITI M3/M6, or Insight XT1 Procyon 4" BBL	STX Plain	Black	5186-73421-411	5186-73421-412	5188-73421-411	5188-73421-412
Glock 17, 22 w/ ITI M3 TLR-1, SureFire X200/X300 4.5" BBL	STX Plain	Black	5186-832-411	5186-832-412	5188-832-411	5188-832-412
Glock 19, 23 w/ ITI M3 TLR-1, SureFire X200/X300 4" BBL	STX Plain	Black	5186-832-411	5186-832-412	5188-832-411	5188-832-412
Glock 17, 22 w/ ITI M3/M6, M3X/M6X, TLR-1/TLR-2, or Insight XT1 Procyon 4.5" BBL	STX Plain	Black	5186-8312-411	5186-8312-412	5188-8312-411	5188-8312-412
Glock 17, 22, w/ ITI M3/M6 TLR-1/TLR-2, SureFire X200/X300 4.5" BBL	STX Plain	Black	5186-8321-411	5186-8321-412	5188-8321-411	5188-8321-412

Concealment Holsters

5186/5188 CONCEALMENT HOLSTERS FOR: PISTOLS W/ LIGHTS (continued)

GUN DESCRIPTION	FINISH*	COLOR	5186		5188	
			RIGHT	LEFT	RIGHT	LEFT
Glock 17, 22 w/ Glock Light System GTL 10 Light Only GTL 21/22 Light/Laser Combination GTL 51/52 Light/Laser Combination 4.5" BBL	STX Plain	Black	5186-8310-411	5186-8310-412	5188-8310-411	5188-8310-412
Glock 20, 21 w/ ITI M3 TLR-1, SureFire X200/X300 4.6" BBL	STX Plain	Black	5186-3832-411	5186-3832-412	5188-3832-411	5188-3832-412
Glock 20, 21 w/ ITI M3/M6, TLR-1/TLR-2 SureFire X200/X300 4.6" BBL	STX Plain	Black	5186-38321-411	5186-38321-412	5188-38321-411	5188-38321-412
Glock 34, 35 w/ ITI M3 or Insight XTI Procyon 5.32" BBL	STX Plain	Black	5186-6832-411	5186-6832-412	5188-6832-411	5188-6832-412
Glock 34, 35 w/ ITI M3/M6, TLR-1/TLR-2 Insight XTI Procyon, SureFire X200/X300 5.32" BBL	STX Plain	Black	5186-68321-411	5186-68321-412	5188-68321-411	5188-68321-412
Heckler & Koch USP 9mm, .40 w/ H&K USP Light Hammer Down N/A for DA only 4.13" BBL	STX Plain	Black	5186-932-411	5186-932-412	5188-932-411	5188-932-412
Heckler & Koch USP .45 LEM D.A.O. w/ SureFire X200, X300 Light 4.41" BBL	STX Plain	Black	5186-1930-411	5186-1930-412	5188-1930-411	5188-1930-412
Heckler & Koch USP .45 w/ H&K USP Light Hammer Down N/A for DA only 4.41" BBL	STX Plain	Black	5186-932-411	5186-932-412	5188-932-411	5188-932-412
Kimber Gold Combat RL, Custom TLE/RL SureFire X200/X300 5" BBL	STX Plain	Black	5186-5340-411	5186-5340-412	5188-5340-411	5188-5340-412
Sig Sauer P220R, P226R DA/SA/DAK w/ Accessory Rails w/ M3/M6 ITI Tactical, Illuminator Light TLR-1/TLR-2, SureFire X200/X300 4.41" BBL	STX Plain	Black	5186-77421-411	5186-77421-412	5188-77421-411	5188-77421-412
Springfield Armory XD 9mm, .40, .357, .45 w/ ITI M3/M6, TLR-1/TLR-2, SureFire X200/X300 4" BBL	STX Plain	Black	5186-14821-411	5186-14821-412	5188-14821-411	5188-14821-412
Springfield Armory XD 9mm, .40, .357, .45 W/ ITI M3/M6, TLR-1/TLR-2, SureFire X200/X300 5" BBL	STX Plain	Black	5186-14921-411	5186-14921-412	5188-14921-411	5188-14921-412
Springfield Armory Operator 1911-A1 w/ SureFire X200/X300 TLR-1 5" BBL	STX Plain	Black	5186-5340-411	5186-5340-412	5188-5340-411	5188-5340-412
Wilson Combat 1911 CQB w/ SureFire X200/X300 Other 1911-style pistols w/SureFire X200/X300 5" BBL	STX Plain	Black	5186-5340-411	5186-5340-412	5188-5340-411	5188-5340-412

How to Order
Duty Holsters
Duty Accessories
Tactical Holsters
Tactical Accessories
Duty Belts
QAS
Speed Loaders
Light Systems
Concealment Holsters
Concealment Accessories
Competition
Apparel
Sales Support
Index/Price List

Concealment Holsters

5186/5188 CONCEALMENT HOLSTERS FOR: REVOLVERS



5186 BELT SIDE



5188 PADDLE & BELT LOOP COMBO

FEATURES

- ▶ Compact and lightweight
- ▶ Genuine SafariLaminate™ construction
- ▶ Low cut sides for ease of draw and added comfort
- ▶ Injection-molded paddle designed for enhanced concealability and comfort on 5188
- ▶ Adjustable injection-molded belt loop fits 1.5" (38mm), 1.75" (45mm) 2" (50mm) and 2.25" (58mm) on 5188 only; please specify
- ▶ Belt loop is user-adjustable for cant angle; can even be worn cross draw
- ▶ IDPA approved
- ▶ Available in STX finishes

*Available in these additional finishes:
 Sample Code 5188-83-481
 STX Basket 5188-XX-48X
 STX Hi Gloss 5188-XX-49X
 STX Foliage Green 5188-XX-54X
 STX Coyote Brown 5188-XX-76X
 STX OD Green 5188-XX-56X
 STX FDE Brown 5188-XX-55X

GUN DESCRIPTION	FINISH*	COLOR	5186		5188	
			RIGHT	LEFT	RIGHT	LEFT
Colt Python 6" BBL	STX Plain	Black	5186-621-411	5186-621-412	5188-621-411	5188-621-412
Ruger Security Six, Service Six 4" BBL	STX Plain	Black	5186-09-411	5186-09-412	5188-09-411	5188-09-412
Ruger GP100 6" BBL	STX Plain	Black	5186-621-411	5186-621-412	5188-621-411	5188-621-412
Ruger Security Six, Service Six 6" BBL	STX Plain	Black	5186-10-411	5186-10-412	5188-10-411	5188-10-412
Smith & Wesson 625, 629 4" BBL	STX Plain	Black	5186-12-411	5186-12-412	5188-12-411	5188-12-412
Smith & Wesson 10, 12, 13, 15, 19, 64 Similar K Frames 4" BBL	STX Plain	Black	5186-09-411	5186-09-412	5188-09-411	5188-09-412
Smith & Wesson 625, 629 5" BBL	STX Plain	Black	5186-13-411	5186-13-412	5188-13-411	5188-13-412
Smith & Wesson 586, 686 6" BBL	STX Plain	Black	5186-621-411	5186-621-412	5188-621-411	5188-621-412
Smith & Wesson 15, 19 Similar K Frames 6" BBL	STX Plain	Black	5186-10-411	5186-10-412	5188-10-411	5188-10-412
Smith & Wesson 625, 629 6" BBL	STX Plain	Black	5186-14-411	5186-14-412	5188-14-411	5188-14-412

Concealment Holsters

5195 RANGE SERIES OPEN TOP LOW-RIDE HOLSTER FOR: PISTOLS

FEATURES

- ▶ Compact and lightweight
- ▶ Low cut sides for ease of draw
- ▶ Offset belt loop allows for a straight up draw
- ▶ Detent in trigger guard for added security
- ▶ Modular offset adapter accommodates the QLS 19 Locking Fork, 745BL and 567BL
- ▶ IDPA approved; also recommended for female shooters
- ▶ Available in 1.5" (38mm) or 1.75" (45mm) belt widths
- ▶ Available in STX finishes



GUN DESCRIPTION	FINISH	COLOR	RIGHT	LEFT
Beretta 92F, 92FS, 92G, 96, 96G 4.9" BBL	STX Plain	Black	5195-73-411	5195-73-412
Colt Commander 4.25" BBL	STX Plain	Black	5195-51-411	5195-51-412
Colt Officers' 3.5" BBL	STX Plain	Black	5195-54-411	5195-54-412
Colt Delta Elite, Government 1911 5" BBL	STX Plain	Black	5195-53-411	5195-53-412
FN FNS 9mm, .40 4" BBL	STX Plain	Black	5195-266-411	5195-266-412
FN FNS 9mm, .40 5" BBL	STX Plain	Black	5195-267-411	5195-267-412
FN FNX 9mm, .40 4" BBL	STX Plain	Black	5195-265-411	5195-265-412
Glock 17, 22 4.5" BBL	STX Plain	Black	5195-83-411	5195-83-412
Glock 19, 23 4" BBL	STX Plain	Black	5195-283-411	5195-283-412
Glock 20, 21 4.6" BBL	STX Plain	Black	5195-383-411	5195-383-412
Glock 26, 27 3.5" BBL	STX Plain	Black	5195-183-411	5195-183-412
Glock 34, 35 5.32" BBL	STX Plain	Black	5195-683-411	5195-683-412
Glock 41 5.31" BBL	STX Plain	Black	5195-683-411	5195-683-412
Heckler & Koch P30 3.875" BBL	STX Plain	Black	5195-295-411	5195-295-412
Smith & Wesson M&P 9mm, .40 4.25" BBL	STX Plain	Black	5195-219-411	5195-219-412
Smith & Wesson M&P 9C/40C 3.38" BBL	STX Plain	Black	5195-319-411	5195-319-412

How to Order
Duty Holsters
Duty Accessories
Tactical Holsters
Tactical Accessories
Duty Belts
QAS
Speed Loaders
Light Systems
Concealment Holsters
Concealment Accessories
Competition
Apparel
Sales Support
Index/Price List

Concealment Holsters

5195 RANGE SERIES OPEN TOP LOW-RIDE HOLSTER FOR: PISTOLS (continued)

How to Order	Duty Holsters	Duty Accessories	Tactical Holsters	Tactical Accessories	Duty Belts	OAS	Speed Loaders	Light Systems	Concealment Holsters	Concealment Accessories	Competition	Apparel	Sales Support	Index/Price List
	GUN DESCRIPTION	FINISH	COLOR	RIGHT	LEFT									
	Smith & Wesson M&P 9L 5" BBL	STX Plain	Black	5195-819-411	5195-819-412									
	Smith & Wesson 1911 5" BBL	STX Plain	Black	5195-53-411	5195-53-412									
	Sphinx SDP Compact 3.7" BBL	STX Plain	Black	5195-282-411	5195-282-412									
	Springfield 1911-A1 5" BBL	STX Plain	Black	5195-53-411	5195-53-412									
	Springfield XD 9mm, .40, .45 4" BBL	STX Plain	Black	5195-48-411	5195-48-412									
	Springfield XD 9mm, .40, .45 5" BBL	STX Plain	Black	5195-49-411	5195-49-412									
	Springfield XD(M) 9mm 5.25" BBL	STX Plain	Black	5195-147-411	5195-147-412									
	STI/SVI 2011 w/Full Dust Cover 5" BBL	STX Plain	Black	5195-850-411	5195-850-412									
	STI/SVI 2011 w/Short Dust Cover 5" BBL	STX Plain	Black	5195-851-411	5195-851-412									
	STI/SVI 2011 w/Short Dust Cover 6" BBL	STX Plain	Black	5195-852-411	5195-852-412									
	Walther P5 3.5" BBL	STX Plain	Black	5195-87-411	5195-87-412									
	Walther P99Q 3.5" BBL	STX Plain	Black	5195-384-411	5195-384-412									

Concealment Holsters

5196/5198/5199 OPEN TOP CONCEALMENT HOLSTERS W/DETENT FOR: PISTOLS



5196 BELT SLIDE



5198 PADDLE & BELT LOOP COMBO



5199 BELT CLIP

FEATURES

- ▶ Adjustable belt loop eliminates common belt bulging and does not interfere with draw
- ▶ Compact and lightweight
- ▶ Detent in trigger guard for reliable weapon security
- ▶ SafariLaminate™ thermal-molded construction
- ▶ Belt loop is user adjustable for cant angle; can even be worn cross draw
- ▶ IDPA approved
- ▶ Available in STX finishes

*Available in these additional finishes:

Sample Code 5196-83-481

STX Basket	5196-XX-48X
STX Hi Gloss	5196-XX-49X
STX Foliage Green	5196-XX-54X
STX Coyote Brown	5196-XX-76X
STX OD Green	5196-XX-56X
STX FDE Brown	5196-XX-55X
STX Red	5196-XX-14X

GUN DESCRIPTION	FINISH*	COLOR	5196		5198		5199	
			RIGHT	LEFT	RIGHT	LEFT	RIGHT	LEFT
Beretta 92F, 92FS, 92G, 96, 96G 4.9" BBL	STX Plain	Black	5196-73-411	5196-73-412	5198-73-411	5198-73-412	5199-73-411	5199-73-412
Colt Officers' 3.5" BBL	STX Plain	Black	5196-54-411	5196-54-412	5198-54-411	5198-54-412	5199-54-411	5199-54-412
Colt Commander 4.25" BBL	STX Plain	Black	5196-51-411	5196-51-412	5198-51-411	5198-51-412	5199-51-411	5199-51-412
Colt Delta Elite, Government 1911 5" BBL	STX Plain	Black	5196-53-411	5196-53-412	5198-53-411	5198-53-412	5199-53-411	5199-53-412
FN FNS 9mm, .40 5" BBL	STX Plain	Black	5196-267-411	5196-267-412	5198-267-411	5198-267-412	5199-267-411	5199-267-412
FN FNS 9mm, .40 4" BBL	STX Plain	Black	5196-266-411	5196-266-412	5198-266-411	5198-266-412	5199-266-411	5199-266-412
FN FNX 9mm, .40 4" BBL	STX Plain	Black	5196-265-411	5196-265-412	5198-265-411	5198-265-412	5199-265-411	5199-265-412
Glock 17, 22 4.5" BBL	STX Plain	Black	5196-83-411	5196-83-412	5198-83-411	5198-83-412	5199-83-411	5199-83-412
Glock 19, 23 4" BBL	STX Plain	Black	5196-283-411	5196-283-412	5198-283-411	5198-283-412	5199-283-411	5199-283-412
Glock 20, 21 4.6" BBL	STX Plain	Black	5196-383-411	5196-383-412	5198-383-411	5198-383-412	5199-383-411	5199-383-412

How to Order
Duty Holsters
Duty Accessories
Tactical Holsters
Tactical Accessories
Duty Belts
QAS
Speed Loaders
Light Systems
Concealment Holsters
Concealment Accessories
Competition
Apparel
Sales Support
Index/Price List

Concealment Holsters

5196/5198/5199 OPEN TOP CONCEALMENT HOLSTERS W/DETENT FOR: PISTOLS

How to Order	Duty Holsters	GUN DESCRIPTION	FINISH*	COLOR	5196		5198		5199	
					RIGHT	LEFT	RIGHT	LEFT	RIGHT	LEFT
Duty Accessories		Glock 26, 27 3.5" BBL	STX Plain	Black	5196-183-411	5196-183-412	5198-183-411	5198-183-412	5199-183-411	5199-183-412
Duty Accessories		Glock 34, 35 5.32" BBL	STX Plain	Black	5196-683-411	5196-683-412	5198-683-411	5198-683-412	5199-683-411	5199-683-412
Tactical Holsters		Glock 41 5.31" BBL	STX Plain	Black	5196-683-411	5196-683-412	5198-683-411	5198-683-412	5199-683-411	5199-683-412
Tactical Accessories		Heckler & Koch P30 3.875" BBL	STX Plain	Black	5196-295-411	5196-295-412	5198-295-411	5198-295-412	5199-295-411	5199-295-412
Tactical Accessories		Kimber Custom .45 5" BBL	STX Plain	Black	5196-53-411	5196-53-412	5198-53-411	5198-53-412	5199-53-411	5199-53-412
Duty Belts		Para-Ordnance P14, P16 5" BBL	STX Plain	Black	5196-53-411	5196-53-412	5198-53-411	5198-53-412	5199-53-411	5199-53-412
OAS		Ruger LC9 3.1" BBL	STX Plain	Black	5196-184-411	5196-184-412	5198-184-411	5198-184-412	5199-184-411	5199-184-412
Speed Loaders		Sig Sauer P227 4.4" BBL	STX Plain	Black	5196-477-411	5196-477-412	5198-477-411	5198-477-412	5199-477-411	5199-477-412
Light Systems		Smith & Wesson 1911 5" BBL	STX Plain	Black	5196-53-411	5196-53-412	5198-53-411	5198-53-412	5199-53-411	5199-53-412
Concealment Holsters		Smith & Wesson M&P 9mm, .40 4.25" BBL	STX Plain	Black	5196-219-411	5196-219-412	5198-219-411	5198-219-412	5199-219-411	5199-219-412
		Smith & Wesson M&P 9L, M&P P9 Pro 5" BBL	STX Plain	Black	5196-819-411	5196-819-412	5198-819-411	5198-819-412	5199-819-411	5199-819-412
Concealment Accessories		Smith & Wesson M&P SHIELD 9mm 3.1" BBL	STX Plain	Black	5196-179-411	5196-179-412	5198-179-411	5198-179-412	5199-179-411	5199-179-412
		Smith & Wesson M&P 9C/40C 3.38" BBL	STX Plain	Black	5196-319-411	5196-319-412	5198-319-411	5198-319-412	5199-319-411	5199-319-412
Competition		Sphinx SDP Compact 3.7" BBL	STX Plain	Black	5196-282-411	5196-282-412	5198-282-411	5198-282-412	5199-282-411	5199-282-412
		Springfield Armory 1911-A1 5" BBL	STX Plain	Black	5196-53-411	5196-53-412	5198-53-411	5198-53-412	5199-53-411	5199-53-412
Apparel		Springfield Armory XD 9mm, .40, .45 4" BBL	STX Plain	Black	5196-48-411	5196-48-412	5198-48-411	5198-48-412	5199-48-411	5199-48-412
		Springfield Armory XD 9mm, .40, .45 5" BBL	STX Plain	Black	5196-49-411	5196-49-412	5198-49-411	5198-49-412	5199-49-411	5199-49-412
Sales Support		Springfield Armory XD(M) 9mm 5.25" BBL	STX Plain	Black	5196-147-411	5196-147-412	5198-147-411	5198-147-412	5199-147-411	5199-147-412
		Springfield Armory XD-S 3.3" BBL	STX Plain	Black	5196-45-411	5196-45-412	5198-45-411	5198-45-412	5199-45-411	5199-45-412
Index/Price List		STI 2011 w/Full Dust Cover 5" BBL	STX Plain	Black	5196-850-411	5196-850-412	5198-850-411	5198-850-412	5199-850-411	5199-850-412

Concealment Holsters

5196/5198/5199 OPEN TOP CONCEALMENT HOLSTERS W/DETENT FOR: PISTOLS (continued)

GUN DESCRIPTION	FINISH*	COLOR	5196		5198		5198	
			RIGHT	LEFT	RIGHT	LEFT	RIGHT	LEFT
STI/SVI 2011 w/Short Dust Cover 5" BBL	STX Plain	Black	5196-851-411	5196-851-412	5198-851-411	5198-851-412	5199-851-411	5199-851-412
STI/SVI 2011 w/Short Dust Cover 6" BBL	STX Plain	Black	5196-852-411	5196-852-412	5198-852-411	5198-852-412	5199-852-411	5199-852-412
Walther P5 3.5" BBL	STX Plain	Black	5196-87-411	5196-87-412	5198-87-411	5198-87-412	5199-87-411	5199-87-412
Walther P99Q 3.5" BBL	STX Plain	Black	5196-384-411	5196-384-412	5198-384-411	5198-384-412	5199-384-411	5199-384-412
Wilson Combat 1911 4.9" BBL	STX Plain	Black	5196-53-411	5196-53-412	5198-53-411	5198-53-412	5199-53-411	5199-53-412

How to Order
Duty Holsters
Duty Accessories
Tactical Holsters
Tactical Accessories
Duty Belts
OAS
Speed Loaders
Light Systems
Concealment Holsters
Concealment Accessories
Competition
Apparel
Sales Support
Index/Price List

Concealment Holsters

5196/5198/5199 OPEN TOP CONCEALMENT HOLSTERS W/ DETENT FOR: REVOLVERS



5196 BELT SLIDE



5198 PADDLE & BELT LOOP COMBO



5199 BELT CLIP

FEATURES

- ▶ Adjustable belt loop eliminates common belt bulging and does not interfere with draw
- ▶ Compact and lightweight
- ▶ Detent in trigger guard for reliable weapon security
- ▶ SafariLaminate™ thermal-molded construction
- ▶ Belt loop is user adjustable for cant angle; can even be worn cross draw
- ▶ IDPA approved
- ▶ Available in STX finishes

Model 5198 is available in seven belt loop sizes:

Sample Codes:

5198-09-411	15" Belt Slots w/ Cut-outs for 1.75" Belt Slots
5198-01-411-150	15" Belt Slots
5198-01-411-175	1.75" Belt Slots
5198-01-411-50	2" Belt Slots
5198-01-411-225	2.25" Belt Slots
5198-01-411-DM	15" Belt Slots w/ Cut-outs for 1.75", 2" and 2.25" Belt Slots w/ 1" Drop
5198-01-411-225DM	2.25" Belt Slots w/ 1" Drop



GUN DESCRIPTION	FINISH*	COLOR	5196		5197		5198	
			RIGHT	LEFT	RIGHT	LEFT	RIGHT	LEFT
Smith and Wesson	STX Plain	Black	5196-01-411	5196-01-412	5198-01-411	5198-01-412	5199-01-411	5199-01-412
J-Frame .38 special only	STX Plain	Red	5196-01-141	5196-01-142	5198-01-141	5198-01-142	5199-01-141	5199-01-142
2" BBL								

Concealment Holsters

5197 RANGE SERIES OPEN TOP MID-RIDE HOLSTER FOR: PISTOLS

FEATURES

- ▶ Adjustable belt loop eliminates common belt bulging and does not interfere with draw
- ▶ Compact and lightweight
- ▶ Detent in trigger guard for reliable weapon security
- ▶ SafariLaminate™ thermal-molded construction
- ▶ Belt loop is user adjustable for cant angle; can even be worn cross draw
- ▶ Available in 1.5" (38mm) or 1.75" (45mm) belt widths
- ▶ IDPA approved
- ▶ Available in SafariSeven™ Plain Black and FDE Brown finishes
- ▶ Available in STX finishes



GUN DESCRIPTION	FINISH	COLOR	RIGHT	LEFT
Beretta 92F, 92FS, 92G, 96, 96G 4.9" BBL	STX Plain STX Plain	Black Red	5197-73-411 5197-73-141	5197-73-412 5197-73-142
Colt Officers' 3.5" BBL	STX Plain STX Plain	Black Red	5197-54-411 5197-54-141	5197-54-412 5197-54-142
Colt Commander 4.25" BBL	STX Plain STX Plain	Black Red	5197-51-411 5197-51-141	5197-51-412 5197-51-142
Colt Delta Elite, Government 1911 5" BBL	STX Plain STX Plain	Black Red	5197-53-411 5197-53-141	5197-53-412 5197-53-142
FN FNS 9mm, .40 5" BBL	STX Plain STX Plain	Black Red	5197-267-411 5197-267-141	5197-267-412 5197-267-142
FN FNS 9mm, .40 4" BBL	STX Plain STX Plain	Black Red	5197-266-411 5197-266-141	5197-266-412 5197-266-142
FN FNX 9mm, .40 4" BBL	STX Plain STX Plain	Black Red	5197-265-411 5197-265-141	5197-265-412 5197-265-142
Glock 17, 22 4.5" BBL	STX Plain STX Plain	Black Red	5197-83-411 5197-83-141	5197-83-412 5197-83-142
Glock 19, 23 4" BBL	STX Plain STX Plain	Black Red	5197-283-411 5197-283-141	5197-283-412 5197-283-142
Glock 20, 21 4.6" BBL	STX Plain STX Plain	Black Red	5197-383-411 5197-383-141	5197-383-412 5197-383-142
Glock 26, 27 3.5" BBL	STX Plain STX Plain	Black Red	5197-183-411 5197-183-141	5197-183-412 5197-183-142
Glock 34, 35 5.32" BBL	STX Plain STX Plain	Black Red	5197-683-411 5197-683-141	5197-683-412 5197-683-142
Glock 41 5.31" BBL	STX Plain STX Plain	Black Red	5197-683-411 5197-683-141	5197-683-412 5197-683-142
Heckler & Koch P30 3.875" BBL	STX Plain STX Plain	Black Red	5197-295-411 5197-295-141	5197-295-412 5197-295-142

How to Order
Duty Holsters
Duty Accessories
Tactical Holsters
Tactical Accessories
Duty Belts
QAS
Speed Loaders
Light Systems
Concealment Holsters
Concealment Accessories
Competition
Apparel
Sales Support
Index/Price List

Concealment Holsters

5197 RANGE SERIES OPEN TOP MID-RIDE HOLSTER FOR: PISTOLS (continued)

How to Order	Duty Holsters	Duty Accessories	Tactical Holsters	Tactical Accessories	Duty Belts	OAS	Speed Loaders	Light Systems	Concealment Holsters	Concealment Accessories	Competition	Apparel	Sales Support	Index/Price List
	<u>GUN DESCRIPTION</u>	<u>FINISH</u>	<u>COLOR</u>	<u>RIGHT</u>	<u>LEFT</u>									
	Kimber Custom .45 5" BBL	STX Plain STX Plain	Black Red	5197-53-411 5197-53-141	5197-53-412 5197-53-142									
	Para-Ordnnance P14, P16 5" BBL	STX Plain STX Plain	Black Red	5197-53-411 5197-53-141	5197-53-412 5197-53-142									
	Ruger LC9 3.1" BBL	STX Plain STX Plain	Black Red	5197-184-411 5197-184-141	5197-184-412 5197-184-142									
	Sig Sauer P227 4.4" BBL	STX Plain STX Plain	Black Red	5197-477-411 5197-477-141	5197-477-412 5197-477-142									
	Smith & Wesson 1911 5" BBL	STX Plain STX Plain	Black Red	5197-53-411 5197-53-141	5197-53-412 5197-53-142									
	Smith & Wesson M&P 9mm, .40 4.25" BBL	STX Plain STX Plain	Black Red	5197-219-411 5197-219-141	5197-219-412 5197-219-142									
	Smith & Wesson M&P 9C/40C 3.38" BBL	STX Plain STX Plain	Black Red	5197-319-411 5197-319-141	5197-319-412 5197-319-142									
	Smith & Wesson M&P 9L, M&P P9 Pro 5" BBL	STX Plain STX Plain	Black Red	5197-819-411 5197-819-141	5197-819-412 5197-819-142									
	Smith & Wesson M&P SHIELD 9mm 3.1" BBL	STX Plain STX Plain	Black Red	5197-179-411 5197-179-141	5197-179-412 5197-179-142									
	Sphinx SDP Compact 3.7" BBL	STX Plain STX Plain	Black Red	5197-282-411 5197-282-141	5197-282-412 5197-282-142									
	Springfield Armory 1911-A1 5" BBL	STX Plain STX Plain	Black Red	5197-53-411 5197-53-141	5197-53-412 5197-53-142									
	Springfield Armory XD 9mm, .40, .45 4" BBL	STX Plain STX Plain	Black Red	5197-48-411 5197-48-141	5197-48-412 5197-48-142									
	Springfield Armory XD 9mm, .40, .45 5" BBL	STX Plain STX Plain	Black Red	5197-49-411 5197-49-141	5197-49-412 5197-49-142									
	Springfield Armory XD(M) 9mm 5.25" BBL	STX Plain STX Plain	Black Red	5197-147-411 5197-147-141	5197-147-412 5197-147-142									
	STI/SVI 2011 w/Short Dust Cover 5" BBL	STX Plain STX Plain	Black Red	5197-851-411 5197-851-141	5197-851-412 5197-851-142									
	STI/SVI 2011 w/Short Dust Cover 6" BBL	STX Plain STX Plain	Black Red	5197-852-411 5197-852-141	5197-852-412 5197-852-142									
	STI/SVI 2011 w/Full Dust Cover 5" BBL	STX Plain STX Plain	Black Red	5197-850-411 5197-850-141	5197-850-412 5197-850-142									

Concealment Holsters

6287 SLS BELT LOOP HOLSTER FOR: PISTOLS

FEATURES

- ▶ SLS (Self Locking System) Rotating Hood
- ▶ Injection-molded belt loop fits 1.5" (38mm), 1.75" (45mm), 2" (50mm), and 2.25" (58mm); please specify
- ▶ Universal Belt Loop available in 7 options
- ▶ Adjustable cant, can be worn strongside or cross draw
- ▶ Closed bottom with drain hole to protect cartridge and officer
- ▶ SafariLaminate™ thermal-molded construction with suede lining
- ▶ Available in Plain Black and STX Tactical® finishes



Model 6287 is available in seven belt loop sizes:	
Sample Codes:	
6287-83-411	1.5" Belt Slots w/ Cut-outs for 1.75" Belt Slots
6287-83-411-150	1.5" Belt Slots
6287-83-411-175	1.75" Belt Slots
6287-83-411-50	2" Belt Slots
6287-83-411-225	2.25" Belt Slots
6287-83-411-DM	1.5" Belt Slots w/ Cut-outs for 1.75", 2" and 2.25" Belt Slots w/ 1" Drop
6287-83-411-225DM	2.25" Belt Slots w/ 1" Drop



6000

6001

6002

Safariland offers three uniquely designed accessories for the SLS holster system, the 6000 hood Guard, the 6001 Sentry (converting the holster to a higher level of security) and the 6002 hood guard/Sentry combination. Available for SLS models including 6004, 6005, 6034, 6035, 6230, 6235, 6280, 6282, 6287, 7004, 7005, 7280, 7282, 7285, and the 7287. ALS Series SLS holsters including the 6360, 6362, 6365, 6304, 6305, 6354, 6355, 6367, 7304, 7305, 7360, 7362, 7365 and the 7367.

Sample Code with Hood Guard installed:
6287-83-131-H
Sample Code with Sentry installed:
6287-83-131-S
Sample Code with Hood Guard/Sentry Installed
6287-83-131-SH

GUN DESCRIPTION	FINISH	COLOR	RIGHT	LEFT
AMT Hardballer 5" BBL	Plain	Black	6287-53-61	6287-53-62
	STX Tactical	Black	6287-53-131	6287-53-132
Beretta Px4 Storm 4" BBL	Plain	Black	6287-180-61	6287-180-62
	STX Tactical	Black	6287-180-131	6287-180-132
Beretta Px4 Storm w/ ITI M3/M6, TLR-1/TLR-2, Insight XT1 Procyon, SureFire X200 or X300 4" BBL	Plain	Black	6287-18021-61	6287-18021-62
	STX Tactical	Black	6287-18021-131	6287-18021-132
Beretta 8000, 8040 Cougar G.F, 8045F 3.6" BBL	Plain	Black	6287-71-61	6287-71-62
	STX Tactical	Black	6287-71-131	6287-71-132

Concealment Holsters

6287 SLS BELT LOOP HOLSTER FOR: PISTOLS

GUN DESCRIPTION	FINISH	COLOR	RIGHT	LEFT
FN Five-Seven 4.8" BBL	Plain	Black	6287-61-61	6287-61-62
	STX Tactical	Black	6287-61-131	6287-61-132
FN Five-Seven w/ ITI Light M3/M6 (N/A for M3X/M6X) 4.8" BBL	Plain	Black	6287-6121-61	6287-6121-62
	STX Tactical	Black	6287-6121-131	6287-6121-132
FN FNP 9mm 4" BBL	Plain	Black	6287-260-61	6287-260-62
	STX Tactical	Black	6287-260-131	6287-260-132
FN FNS 9mm, .40 4" BBL	Plain	Black	6287-266-61	6287-266-62
	STX Plain	Black	6287-266-131	6287-266-132
FN FNX 9mm, .40 4" BBL	Plain	Black	6287-265-61	6287-265-62
	STX Plain	Black	6287-265-131	6287-265-132
FN FNP .45 4.5" BBL	Plain	Black	6287-261-61	6287-261-62
	STX Tactical	Black	6287-261-131	6287-261-132
Glock 17, 22 4.5" BBL	Plain	Black	6287-83-61	6287-83-62
	STX Tactical	Black	6287-83-131	6287-83-132
Glock 17, 22 w/ Dual Magazine Release 4.5" BBL	Plain	Black	6287-983-61	6287-983-62
	STX Tactical	Black	6287-983-131	6287-983-132
Glock 17, 22 w/ Dual Magazine Release w/ ITI M3 Light 4.5" BBL	Plain	Black	6287-9832-61	6287-9832-62
	STX Tactical	Black	6287-9832-131	6287-9832-132
Glock 17, 22 w/ GTL 10 Light Only GTL 21/22 Light/Laser Combination GTL 51/52 Light/Laser Combination 4.5" BBL	Plain	Black	6287-8310-61	6287-8310-62
	STX Tactical	Black	6287-8310-131	6287-8310-132
Glock 17, 22 w/ Dual Magazine Release & GTL 10 light only GTL 21, 22 Light/Laser Combination GTL 51, 52 Light/Laser Combination 4.5" BBL	Plain	Black	6287-98310-61	6287-98310-62
	STX Tactical	Black	6287-98310-131	6287-98310-132
Glock 17, 22 w/ SureFire X200/X300/X300U 4.5 BBL	Plain	Black	6287-836-61	6287-836-62
	STX Tactical	Black	6287-836-131	6287-836-132
Glock 17, 22 w/ SureFire X400/X400U 4.5 BBL	Plain	Black	6287-8314-61	6287-8314-62
	STX Tactical	Black	6287-8314-131	6287-8314-132
Glock 19, 23 4" BBL 36 3.75" BBL	Plain	Black	6287-283-61	6287-283-62
	STX Tactical	Black	6287-283-131	6287-283-132
Glock 19, 23 w/ Dual Magazine Release 4" BBL	Plain	Black	6287-9283-61	6287-9283-62
	STX Tactical	Black	6287-9283-131	6287-9283-132
Glock 19, 23 w/ SureFire X400 4" BBL	Plain	Black	6287-8314-61	6287-8314-62
	STX Tactical	Black	6287-8314-131	6287-8314-132

How to Order
Duty Holsters
Duty Accessories
Tactical Holsters
Tactical Accessories
Duty Bats
QAS
Speed Loaders
Light Systems
Concealment Holsters
Concealment Accessories
Competition
Apparel
Sales Support
Index/Price List

Concealment Holsters

6287 SLS BELT LOOP HOLSTER FOR: PISTOLS (continued)

GUN DESCRIPTION	FINISH	COLOR	RIGHT	LEFT
Heckler & Koch USP 9mm, .40 Hammer Down or Cocked & Locked w/ B&T Adapter ITI M3/M6 and M3 LED 4.13" BBL	Plain STX Tactical	Black Black	6287-9221-61 6287-9221-131	6287-9221-62 6287-9221-132
Heckler & Koch USP 9mm, .40, .45 Hammer Down SureFire X200/X300, TLR-1/TLR-2, Insight XTI Procyon USP 9mm, .40 4.13" BBL USP 45 4.41" BBL	Plain STX Tactical	Black Black	6287-9321-61 6287-9321-131	6287-9321-62 6287-9321-132
Heckler & Koch USP 9mm DAO w/ SureFire Mount P105, P115 SureFire Light Holster will retain pistol	Plain STX Tactical	Black Black	6287-1936-61 6287-1936-131	6287-1936-62 6287-1936-132
Heckler & Koch USP .45, LEM DAO Bobbed Hammer, USP .45 Spurred Hammer w/ SureFire MR09 Light Adapter and SureFire X200/X300 4.41" BBL	Plain STX Tactical	Black Black	6287-930-61 6287-930-131	6287-930-62 6287-930-132
Heckler & Koch HK .45 4.53" BBL	Plain STX Tactical	Black Black	6287-393-61 6287-393-131	6287-393-62 6287-393-132
Heckler & Koch HK .45 Cocked & Locked TLR-1, SureFire X200/X300, LAS-TAC 2, SSL-1 4.53" BBL	Plain STX Tactical	Black Black	6287-3930-61 6287-3930-131	6287-3930-62 6287-3930-132
Heckler & Koch P2000 US Version w/ ITI M3/M6 Light Holster will NOT retain pistol w/o light attached 3.5" BBL	Plain STX Tactical	Black Black	6287-19721-61 6287-19721-131	6287-19721-62 6287-19721-132
Heckler & Koch P2000 DAO w/ B&T Adapter & GTL 10 Light only GTL 21/22 Light/Laser Combination GTL 51/52 Light/Laser Combination 3.5" BBL	Plain STX Tactical	Black Black	6287-9710-61 6287-9710-131	6287-9710-62 6287-9710-132
Heckler & Koch P2000 DAO USA Version w/ M3X Light, Bobbed Hammer 3.66" BBL	Plain STX Tactical	Black Black	6287-9711-61 6287-9711-131	6287-9711-62 6287-9711-132
Heckler & Koch P2000 European Version w/ B&T Adapter (TL P2000) w/ M3/M6 ITI Tactical Illuminator Light Holster will NOT retain pistol w/o light attached 3.5" BBL	Plain STX Tactical	Black Black	6287-9721-61 6287-9721-131	6287-9721-62 6287-9721-132
Kimber Gold Combat Custom TLE/RL 5" BBL	Plain STX Tactical	Black Black	6287-5340-61 6287-5340-131	6287-5340-62 6287-5340-132
Sig Sauer P220, P226 4.41" BBL	Plain STX Tactical	Black Black	6287-77-61 6287-77-131	6287-77-62 6287-77-132
Sig Sauer P220R DAK, P226R DAK w/ Bobbed Hammer 4.41" BBL	Plain STX Tactical	Black Black	6287-277-61 6287-277-131	6287-277-62 6287-277-132

How to Order
Duty Holsters
Duty Accessories
Tactical Holsters
Tactical Accessories
Duty Bats
QAS
Speed Loaders
Light Systems
Concealment Holsters
Concealment Accessories
Competition
Apparel
Sales Support
Index/Price List

Concealment Holsters

6287 SLS BELT LOOP HOLSTER FOR: PISTOLS (continued)

How to Order	Duty Holsters	Duty Accessories	Tactical Holsters	Tactical Accessories	Duty Belts	OAS	Speed Loaders	Light Systems	Concealment Holsters	Concealment Accessories	Competition	Apparel	Sales Support	Index/Price List
	GUN DESCRIPTION	FINISH	COLOR	RIGHT	LEFT									
	Sig Sauer P220, P226 w/ ITI Light Mount, w/ ITI M3/M6 4.41" BBL	Plain STX Tactical	Black Black	6287-7721-61 6287-7721-131	6287-7721-62 6287-7721-132									
	Sig Sauer P220, P226 w/ ITI Mount w/ ITI M3X/M6X 4.41" BBL	Plain STX Tactical	Black Black	6287-7712-61 6287-7712-131	6287-7712-62 6287-7712-132									
	Sig Sauer P220R, P226R w/ MOLAD Light Laser 4.41" BBL	Plain STX Tactical	Black Black	6287-77413-61 6287-77413-131	6287-77413-62 6287-77413-132									
	Sig Sauer P220SO, P220ST, P220R, P226R w/ SureFire X200/X300 4.41" BBL	Plain STX Tactical	Black Black	6287-7740-61 6287-7740-131	6287-7740-62 6287-7740-132									
	Sig Sauer P220R, P226R w/ SureFire X400/X400U 4.41" BBL	Plain STX Tactical	Black Black	6287-77414-61 6287-77414-131	6287-77414-62 6287-77414-132									
	Sig Sauer P220R DAK, P226R DAK Bobbed Hammer w/ SureFire X200/X300 Holster will NOT retain pistol w/o light attached 4.41" BBL	Plain STX Tactical	Black Black	6287-2770-61 6287-2770-131	6287-2770-62 6287-2770-132									
	Sig Sauer P220R DAK, P226R DAK w/ Bobbed Hammer w/ ITI M3/M6 4.41" BBL	Plain STX Tactical	Black Black	6287-27721-61 6287-27721-131	6287-27721-62 6287-27721-132									
	Sig Sauer P226R MK25 4.5" BBL	Plain STX Tactical	Black Black	6287-77-61 6287-77-131	6287-77-62 6287-77-132									
	Sig Sauer P226 w/ SureFire MR14 Rail & SureFire X200/X300 4.41" BBL	Plain STX Tactical	Black Black	6287-7700-61 6287-7700-131	6287-7700-62 6287-7700-132									
	Sig Sauer P226R X-Five w/ SureFire X200/X300 5" BBL	Plain STX Tactical	Black Black	6287-3770-61 6287-3770-131	6287-3770-62 6287-3770-132									
	Sig Sauer P227 4.4" BBL	Plain STX Tactical	Black Black	6287-77-61 6287-77-131	6287-77-62 6287-77-132									
	Sig Sauer P225, P228, P229, P229R 3.86" BBL	Plain STX Tactical	Black Black	6287-74-61 6287-74-131	6287-74-62 6287-74-132									
	Sig Sauer P229R DAK DAO 3.9" BBL	Plain STX Tactical	Black Black	6287-174-61 6287-174-131	6287-174-62 6287-174-132									
	Sig Sauer P229R w/ Accessory Rail DA/SA (Spurred Hammer) w/ ITI or Streamlight Tactical Illuminator Light M3/M6 (N/A M3X/M6X) 3.9" BBL	Plain STX Tactical	Black Black	6287-74421-61 6287-74421-131	6287-74421-62 6287-74421-132									
	Sig Sauer P229R DAK w/ Light Rails Bobbed Hammer w/ ITI Tactical Illuminator Light M3/M6 and M3 LED 3.9" BBL	Plain STX Tactical	Black Black	6287-17421-61 6287-17421-131	6287-17421-62 6287-17421-132									

Concealment Holsters

6287 SLS BELT LOOP HOLSTER FOR: PISTOLS (continued)

GUN DESCRIPTION	FINISH	COLOR	RIGHT	LEFT
Sig Sauer P229R DAK Bobbed Hammer w/ Insight Technology M3X/M6X Light Holster will NOT retain pistol w/o light attached 3.9" BBL	Plain STX Tactical	Black Black	6287-17412-61 6287-17412-131	6287-17412-62 6287-17412-132
Sig Sauer P229R DAK w/ Bobbed Hammer w/ SF X200/X300 3.9" BBL	Plain STX Tactical	Black Black	6287-1740-61 6287-1740-131	6287-1740-62 6287-1740-132
Sig Sauer Sig Pro P2022 w/ Light Mount Rail 3.5" BBL	Plain STX Tactical	Black Black	6287-278-61 6287-278-131	6287-278-62 6287-278-132
Sig Sauer Sig Pro P2022 w/ ITI M3/M6 3.5" BBL	Plain STX Tactical	Black Black	6287-27821-61 6287-27821-131	6287-27821-62 6287-27821-132
Sig Sauer Sig Pro SP2340 3.875" BBL	Plain STX Tactical	Black Black	6287-78-61 6287-78-131	6287-78-62 6287-78-132
Sig Sauer P239 3.625" BBL	Plain STX Tactical	Black Black	6287-75-61 6287-75-131	6287-75-62 6287-75-132
Sig Sauer P250 Compact 9mm, .40, .45 3.875" BBL	Plain STX Tactical	Black Black	6287-750-61 6287-750-131	6287-750-62 6287-750-132
Sig Sauer P250 9mm, .40, .45 4.7" BBL	Plain STX Tactical	Black Black	6287-450-61 6287-450-131	6287-450-62 6287-450-132
Sig Sauer GSR Revolution 1911 w/ & w/o Light Rails 5" BBL	Plain STX Tactical	Black Black	6287-256-61 6287-256-131	6287-256-62 6287-256-132
Sig Sauer 1911 GSR w/ ITI M3/M6 Streamlight TLR-1/TLR-2, SureFire X200/X300, SSL-1 5" BBL	Plain STX Tactical	Black Black	6287-25621-61 6287-25621-131	6287-25621-62 6287-25621-132
Smith & Wesson 3953, 3954 Single Stack D/A Only 3.5" BBL	Plain STX Tactical	Black Black	6287-321-61 6287-321-131	6287-321-62 6287-321-132
Smith & Wesson Sigma 9C, Sigma 40C 4" BBL	Plain STX Tactical	Black Black	6287-39-61 6287-39-131	6287-39-62 6287-39-132
Smith & Wesson Sigma 9F, Sigma 40F 4.5" BBL	Plain STX Tactical	Black Black	6287-40-61 6287-40-131	6287-40-62 6287-40-132
Smith & Wesson 4006, 4043, 4046, 5903, 5904, 5906 4" BBL Short Round Trigger Guard. All w/ Full size serrated hammer 4046, 5946 4" BBL DA Only 4006TSW, 4046TSW, 5906TSW, 5946TSW, w/ Light Rails 4" BBL	Plain STX Tactical	Black Black	6287-140-61 6287-140-131	6287-140-62 6287-140-132
Smith & Wesson 4006TSW, w/ Bolt on S&W Light Rail, 4006TSW w/ Bobbed Hammer & Picatinny Light Rail 4" BBL	Plain STX Tactical	Black Black	6287-141-61 6287-141-131	6287-141-62 6287-141-132

How to Order
Duty Holsters
Duty Accessories
Tactical Holsters
Tactical Accessories
Duty Belts
QAS
Speed Loaders
Light Systems
Concealment Holsters
Concealment Accessories
Competition
Apparel
Sales Support
Index/Price List

Concealment Holsters

6287 SLS BELT LOOP HOLSTER FOR: PISTOLS (continued)

How to Order	Duty Holsters	Duty Accessories	Tactical Holsters	Tactical Accessories	Duty Belts	OAS	Speed Loaders	Light Systems	Concealment Holsters	Concealment Accessories	Competition	Apparel	Sales Support	Index/Price List
	GUN DESCRIPTION	FINISH	COLOR	RIGHT	LEFT									
	Smith & Wesson M&P 9mm, .40 4.5" BBL	Plain STX Tactical	Black Black	6287-219-61 6287-219-131	6287-219-62 6287-219-132									
	Smith & Wesson M&P 9mm, .40 w/ M3/M6 ITI Tactical Illuminator Light Streamlight TLR-1/TLR-2 Holster will NOT retain pistol w/o light attached 4.5" BBL	Plain STX Tactical	Black Black	6287-21921-61 6287-21921-131	6287-21921-62 6287-21921-132									
	Smith & Wesson M&P 9C/40C 3.38" BBL	Plain STX Plain	Black Black	6287-319-61 6287-319-411	6287-319-62 6287-319-412									
	Smith & Wesson M&P .45 w/ & w/o Safety 4.5" BBL	Plain STX Tactical	Black Black	6287-519-61 6287-519-131	6287-519-62 6287-519-132									
	Smith & Wesson M&P .45 w/ & w/o Safety w/ ITI M3/M6, TLR-1/TLR-2 SureFire X200/X300, LAS-TAC 2 4.5" BBL	Plain STX Tactical	Black Black	6287-51921-61 6287-51921-131	6287-51921-62 6287-51921-132									
	Smith & Wesson 1006, 4506-1, 1026, 4526 5" BBL 4566TSW, 4563TSW 4.25" BBL	Plain STX Tactical	Black Black	6287-210-61 6287-210-131	6287-210-62 6287-210-132									
	Smith & Wesson 4053 3.5" BBL	Plain STX Tactical	Black Black	6287-340-61 6287-340-131	6287-340-62 6287-340-132									
	Smith & Wesson S&W 4566TSW w/ Light Rails and ITI M5 4.125" BBL	Plain STX Tactical	Black Black	6287-4302-61 6287-4302-131	6287-4302-62 6287-4302-132									
	Smith & Wesson SW99 4" BBL	Plain STX Tactical	Black Black	6287-84-61 6287-84-131	6287-84-62 6287-84-132									
	Smith & Wesson SW99, 45ACP 4.25" BBL	Plain STX Tactical	Black Black	6287-86-61 6287-86-131	6287-86-62 6287-86-132									
	Sphinx 3000 3.75" BBL Cocked & Locked or Hammer Down 4.5" BBL	Plain STX Tactical	Black Black	6287-182-61 6287-182-131	6287-182-62 6287-182-132									
	Sphinx 3000 3.75" BBL Cocked & Locked or Hammer Down w/ ITI LAM Light 4.5" BBL	Plain STX Tactical	Black Black	6287-1825-61 6287-1825-131	6287-1825-62 6287-1825-132									
	Sphinx SDP Compact 3.7" BBL	Plain STX Plain	Black Black	6287-282-61 6287-282-411	6287-282-62 6287-282-412									
	Springfield Armory XD(M) 9mm 3.8" BBL	Plain STX Tactical	Black Black	6287-148-61 6287-148-131	6287-148-62 6287-148-132									
	Springfield Armory XD 9mm, .40, .357, .45 4" BBL	Plain STX Tactical	Black Black	6287-148-61 6287-148-131	6287-148-62 6287-148-132									

Concealment Holsters

6287 SLS BELT LOOP HOLSTER FOR: PISTOLS (continued)

GUN DESCRIPTION	FINISH	COLOR	RIGHT	LEFT
Springfield Armory XD, 9mm, .40, .45 w/ ITI M3/M6, TLR-1, TLR-2, SureFire X200/ X300 or LAS-TAC 2 4" BBL	Plain STX Tactical	Black Black	6287-14821-61 6287-14821-131	6287-14821-62 6287-14821-132
Springfield Armory XD, 9mm, .40, .357, .45 5" BBL	Plain STX Tactical	Black Black	6287-149-61 6287-149-131	6287-149-62 6287-149-132
Springfield Armory XD(M) 9mm, .40, .45 4.5" BBL	Plain STX Tactical	Black Black	6287-149-61 6287-149-131	6287-149-62 6287-149-132
Springfield Armory XD 9mm, .40, .357, .45 5" BBL w/ ITI M3/M6, TLR-1/TLR-2, Insight XTI Procyon, SureFire X200/X300 or LAS-TAC2 XD(M) .40 4.5" BBL	Plain STX Tactical	Black Black	6287-14921-61 6287-14921-131	6287-14921-62 6287-14921-132
Springfield Armory 1911-A1 5" BBL	Plain STX Tactical	Black Black	6287-53-61 6287-53-131	6287-53-62 6287-53-132
Springfield Armory 1911-A1, PX9105L w/ Picatinny Light Rail 5" BBL	Plain STX Tactical	Black Black	6287-56-61 6287-56-131	6287-56-62 6287-56-132
Springfield Armory 1911-A1 w/ ITI M3X/M6X 5" BBL	Plain STX Tactical	Black Black	6287-5612-61 6287-5612-131	6287-5612-62 6287-5612-132
Stinger S-200	Plain STX Tactical	Black Black	6287-164-61 6287-164-131	6287-164-62 6287-164-132
Tangfolio Force 4.4" BBL	Plain STX Tactical	Black Black	6287-262-61 6287-262-131	6287-262-62 6287-262-132
Taser® Advanced Taser M26	Plain STX Tactical	Black Black	6287-63-61 6287-63-131	6287-63-62 6287-63-132
Taser® X3	Plain STX Tactical	Black Black	6287-163-61 6287-163-131	6287-163-62 6287-163-132
Taser® X26	Plain STX Tactical	Black Black	6287-64-61 6287-64-131	6287-64-62 6287-64-132
Walther P-5 3.5" BBL	Plain STX Tactical	Black Black	6287-87-61 6287-87-131	6287-87-62 6287-87-132
Walther P99C QA 3.375" BBL	Plain STX Tactical	Black Black	6287-84-61 6287-84-131	6287-84-62 6287-84-132
Wilson Combat 1911 4.875" BBL	Plain STX Tactical	Black Black	6287-53-61 6287-53-131	6287-53-62 6287-53-132
SLS Hood Guard		Black	6000-1	6000-2
SLS Sentry		Black	6001-1	6001-2
SLS Hood Guard/Sentry		Black	6002-1	6002-2

How to Order
Duty Holsters
Duty Accessories
Tactical Holsters
Tactical Accessories
Duty Belts
QAS
Speed Loaders
Light Systems
Concealment Holsters
Concealment Accessories
Competition
Apparel
Sales Support
Index/Price List

Concealment Holsters

6367 ALS®/SLS BELT LOOP HOLSTER FOR: PISTOLS



FEATURES

- ▶ ALS® (Automatic Locking System) secures weapon once holstered; simple straight up draw once all releases are deactivated
- ▶ Includes SLS hood assembly and Hood Guard
- ▶ Optional Sentry available
- ▶ Adjustable injection molded belt loop fits 1.5" (38mm), 1.75" (45mm), 2" (50mm) and 2.25" (58mm); please specify
- ▶ Available in Plain Black and STX Tactical® finishes

Safariland offers three uniquely designed accessories for the SLS holster system, the 6000 hood Guard, the 6001 Sentry (converting the holster to a higher level of security) and the 6002 hood guard/Sentry combination. Available for SLS models including 6004, 6005, 6034, 6035, 6230, 6235, 6280, 6282, 6287, 7004, 7005, 7280, 7282, 7285, and the 7287. ALS Series SLS holsters including the 6360, 6362, 6365, 6304, 6305, 6354, 6355, 6367, 7304, 7305, 7360, 7362, 7365 and the 7367.

Model 6367 Concealment Holster Includes Installed Hood Guard
 Sample Code with Sentry installed:
 6367-83-131-S.
 Sample Code with Hood Guard Sentry installed:
 6367-83-131-SH.

*Available in these additional finishes:
 Sample Code 6367-83-411
 STX Plain 6367-XX-41X
 STX Basket 6367-XX-48X
 STX Hi Gloss 6367-XX-49X

Model 6367 is available in seven belt loop sizes:

Sample Codes:

6367-83-411	1.5" Belt Slots w/ Cut-outs for 1.75" Belt Slots
6367-83-411-150	1.5" Belt Slots
6367-83-411-175	1.75" Belt Slots
6367-83-411-50	2" Belt Slots
6367-83-411-225	2.25" Belt Slots
6367-83-411-DM	1.5" Belt Slots w/ Cut-outs for 1.75", 2" and 2.25" Belt Slots w/ 1" Drop
6367-83-411-225DM	2.25" Belt Slots w/ 1" Drop



Concealment Holsters

6367 ALS®/SLS BELT LOOP HOLSTER FOR: PISTOLS (continued)

GUN DESCRIPTION	FINISH*	COLOR	RIGHT	LEFT
Beretta Px4 Storm 9mm, .40 4" BBL	Plain STX Tactical	Black Black	6367-180-61 6367-180-131	6367-180-62 6367-180-132
Beretta Px4 Storm .45ACP 4.1" BBL	Plain STX Tactical	Black Black	6367-185-61 6367-185-131	6367-185-62 6367-185-132
Beretta 92F, 92FS, 92G, 96, 96G 4.9" BBL	Plain STX Tactical	Black Black	6367-73-61 6367-73-131	6367-73-62 6367-73-132
Colt Government 1911 5" BBL	Plain STX Tactical	Black Black	6367-53-61 6367-53-131	6367-53-62 6367-53-132
CZ P-07 3.8" BBL	Plain STX Tactical	Black Black	6367-292-61 6367-292-131	6367-292-62 6367-292-132
FN FNS .40 4" BBL	Plain STX Tactical	Black Black	6367-266-61 6367-266-131	6367-266-62 6367-266-132
Glock 17, 22 4.5" BBL	Plain STX Tactical	Black Black	6367-83-61 6367-83-131	6367-83-62 6367-83-132
Glock 17, 22 w/ Dual Mag Release 4.5" BBL	Plain STX Tactical	Black Black	6367-983-61 6367-983-131	6367-983-62 6367-983-132
Glock 17, 22, w/ ITI M3, TLR-1, TLR-1HL, SureFire X200/X300/X300U 4.5" BBL	Plain STX Tactical	Black Black	6367-832-61 6367-832-131	6367-832-62 6367-832-132
Glock 17, 22 w/ GTL 10 Light Only GTL 21, 22 Light/Laser Combination GTL 51, 52 Light/Laser Combination 4.5" BBL	Plain STX Tactical	Black Black	6367-8310-61 6367-8310-131	6367-8310-62 6367-8310-132
Glock 19, 23 4" BBL	Plain STX Tactical	Black Black	6367-283-61 6367-283-131	6367-283-62 6367-283-132
Glock 19, 23 w/ ITI M3, TLR-1HL SureFire X200/X300/X300U 4" BBL	Plain STX Tactical	Black Black	6367-2832-61 6367-2832-131	6367-2832-62 6367-2832-132
Glock 20, 21 4.6" BBL	Plain STX Tactical	Black Black	6367-383-61 6367-383-131	6367-383-62 6367-383-132
Glock 20, 21 w/ ITI M3, TLR-1, TLR-1HL, SureFire X200/X300/X300U 4.6" BBL	Plain STX Tactical	Black Black	6367-3832-61 6367-3832-131	6367-3832-62 6367-3832-132
Glock 30S 23.77" BBL	Plain STX Tactical	Black Black	6367-485-61 6367-485-131	6367-485-62 6367-485-132
Glock 29, 30 3.78" BBL	Plain STX Tactical	Black Black	6367-483-61 6367-483-131	6367-483-62 6367-483-132
Glock 34, 35 5.32" BBL	Plain STX Tactical	Black Black	6367-683-61 6367-683-131	6367-683-62 6367-683-132
Glock 34, 35 w/ ITI M3, TLR-1, TLR-1HL, SureFire X200/X300/X300U 5.32" BBL	Plain STX Tactical	Black Black	6367-6832-61 6367-6832-131	6367-6832-62 6367-6832-132

How to Order
Duty Holsters
Duty Accessories
Tactical Holsters
Tactical Accessories
Duty Bats
QAS
Speed Loaders
Light Systems
Concealment Holsters
Concealment Accessories
Competition
Apparel
Sales Support
Index/Price List

Concealment Holsters

6367 ALS®/SLS BELT LOOP HOLSTER FOR: PISTOLS (continued)

GUN DESCRIPTION	FINISH*	COLOR	RIGHT	LEFT
Sig Sauer P225 3.86" BBL	Plain STX Tactical	Black Black	6367-79-61 6367-79-131	6367-79-62 6367-79-132
Sig Sauer P228, P229 3.9" BBL	Plain STX Tactical	Black Black	6367-74-61 6367-74-131	6367-74-62 6367-74-132
Sig Sauer P229R w/ ITI M3, TLR-1, TLR-1HL, SureFire X200/X300/X300U 3.9" BBL	Plain STX Tactical	Black Black	6367-7742-61 6367-7742-131	6367-7742-62 6367-7742-132
Sig Sauer P229R DAK .40 w/ Bobbed Hammer; P229R DA/SA .40 w/ Full Size Hammer 3.9" BBL	Plain STX Tactical	Black Black	6367-447-61 6367-447-131	6367-447-62 6367-447-132
Sig Sauer P239 3.625" BBL	Plain STX Tactical	Black Black	6367-754-61 6367-754-131	6367-754-62 6367-754-132
Sig Sauer P250 Compact 9mm, .40, .45 3.875" BBL	Plain STX Tactical	Black Black	6367-750-61 6367-750-131	6367-750-62 6367-750-132
Sig Sauer P250 9mm, .40, .45 4.7" BBL	Plain STX Tactical	Black Black	6367-450-61 6367-450-131	6367-450-62 6367-450-132
Sig Sauer SP2022 3.87" BBL	Plain STX Tactical	Black Black	6367-278-61 6367-278-131	6367-278-62 6367-278-132
Sig Sauer P320 4.7" BBL	Plain STX Tactical	Black Black	6367-450-61 6367-450-131	6367-450-62 6367-450-132
Sig Sauer P320C 3.9" BBL	Plain STX Tactical	Black Black	6367-750-61 6367-750-131	6367-750-62 6367-750-132
Smith & Wesson M&P 9mm, .40, .22LR 4.25" BBL M&P 9C 3.375" BBL	Plain STX Tactical	Black Black	6367-219-61 6367-219-131	6367-219-62 6367-219-132
Smith & Wesson M&P 9mm, .40, w/ ITI, TLR-1HL, TLR-1 or SureFire X200/X300/X300U 4.25" BBL	Plain STX Tactical	Black Black	6367-2192-61 6367-2192-131	6367-2192-62 6367-2192-132
Smith & Wesson M&P 9L 5" BBL	Plain STX Tactical	Black Black	6367-819-61 6367-819-131	6367-819-62 6367-819-132
Smith & Wesson M&P 9L w/ Thumb Safety 5" BBL	Plain STX Tactical	Black Black	6367-820-61 6367-820-131	6367-819-62 6367-820-132
Smith & Wesson M&P 45C w/o Thumb Safety 4" BBL	Plain STX Tactical	Black Black	6367-919-61 6367-919-131	6367-919-62 6367-919-132
Smith & Wesson M&P 45C w/ Thumb Safety 4" BBL	Plain STX Tactical	Black Black	6367-920-61 6367-920-131	6367-920-62 6367-920-132
Smith & Wesson M&P 45C w/o Manual Thumb Safety and ITI M3, TLR-1, TLR-1HL SureFire X200/X300/X300U 4" BBL	Plain STX Tactical	Black Black	6367-9192-61 6367-9192-131	6367-9192-62 6367-9192-132

How to Order
Duty Holsters
Duty Accessories
Tactical Holsters
Tactical Accessories
Duty Bats
QAS
Speed Loaders
Light Systems
Concealment Holsters
Concealment Accessories
Competition
Apparel
Sales Support
Index/Price List

Concealment Holsters

6367 ALS®/SLS BELT LOOP HOLSTER FOR: PISTOLS (continued)

GUN DESCRIPTION	FINISH*	COLOR	RIGHT	LEFT
Springfield Armory XD(M) 9mm 4.5" BBL	Plain STX Tactical	Black Black	6367-145-61 6367-145-131	6367-145-62 6367-145-132
Springfield Armory XD(M) .40 4.5" BBL	Plain STX Tactical	Black Black	6367-146-61 6367-146-131	6367-146-62 6367-146-132
Springfield Armory XD .45 w/ ITI M3, TLR-1, TLR-1HL, SureFire X200/X300/X300U 5" BBL	Plain STX Tactical	Black Black	6367-1492-61 6367-1492-131	6367-1492-62 6367-1492-132
Springfield Armory Operator 1911-A1 w/ Picatinny Light Rail 5" BBL	Plain STX Tactical	Black Black	6367-56-61 6367-56-131	6367-56-62 6367-56-132
Springfield Armory Operator 1911A-1 w/ SureFire X200/X300/X300U, TLR-1HL 5" BBL	Plain STX Tactical	Black Black	6367-560-61 6367-560-131	6367-560-62 6367-560-132
Taurus PT840, PT809 4" BBL	Plain STX Tactical	Black Black	6367-268-61 6367-268-131	6367-268-62 6367-268-132
Walther P99 4" BBL	Plain STX Tactical	Black Black	6367-84-61 6367-84-131	6367-84-62 6367-84-132
Walther P99C 4.5" BBL	Plain STX Tactical	Black Black	6367-284-61 6367-284-131	6367-284-62 6367-284-132
Walther PPQ 4" BBL	Plain STX Tactical	Black Black	6367-384-61 6367-384-131	6367-384-62 6367-384-132
SLS Hood Guard		Black	6000-1	6000-2
SLS Sentry		Black	6001-1	6001-2
SLS Hood Guard/Sentry		Black	6002-1	6002-2

How to Order
Duty Holsters
Duty Accessories
Tactical Holsters
Tactical Accessories
Duty Bats
QAS
Speed Loaders
Light Systems
Concealment Holsters
Concealment Accessories
Competition
Apparel
Sales Support
Index/Price List

Concealment Holsters

6376/6377/6378/6379 ALS® HOLSTERS FOR: PISTOLS

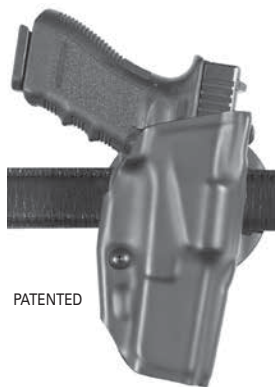

PATENTED

6376 BELT SLIDE



PATENTED

6377 BELT LOOP



PATENTED

6378 PADDLE & BELT LOOP COMBO



PATENTED



back view

6379 BELT CLIP

FEATURES

- ▶ ALS® (Automatic Locking System) secures weapon once holstered; simple straight up draw once ALS is deactivated by thumb while obtaining shooting grip
- ▶ Optional ALS® Guard available for increased security
- ▶ Available in STX finishes
- ▶ Slim and low profile design for improved concealment
- ▶ Low-ride design for ease of draw

Model 6377 is available in seven belt loop sizes:

Sample Codes:

6377-83-411	15" Belt Slots w/ Cut-outs for 1.75" Belt Slots
6377-83-411-150	15" Belt Slots
6377-83-411-175	1.75" Belt Slots
6377-83-411-50	2" Belt Slots
6377-83-411-225	2.25" Belt Slots
6377-83-411-DM	15" Belt Slots w/ Cut-outs for 1.75", 2" and 2.25" Belt Slots w/ 1" Drop
6377-83-411-225DM	2.25" Belt Slots w/ 1" Drop



ALS Guard – Unlocked

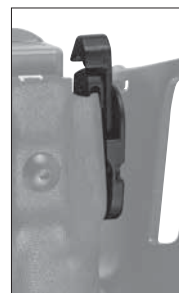

ALS Guard – Locked



Models 6376/6377/6378/6379 Concealment Holsters can include the ALS Guard installed
Sample Code with ALS Guard Only:
6377-83-131-AG

*Available in these additional finishes:
Sample Code 6378-83-411
STX Plain 6378-XX-41X
STX Basket 6378-XX-48X
STX Hi Gloss 6378-XX-49X

Concealment Holsters

6376/6377/6378/6379 ALS® HOLSTERS FOR: PISTOLS (continued)

GUN DESCRIPTION	FINISH	COLOR	6376		6377		6378		6379	
			RIGHT	LEFT	RIGHT	LEFT	RIGHT	LEFT	RIGHT	LEFT
Beretta Px4 Storm, 9mm, .40 4" BBL	STX Plain	Black	6376-180-411	6376-180-412	6377-180-411	6377-180-412	6378-180-411	6378-180-412	6379-180-411	6379-180-412
Beretta Px4 Storm .45ACP 4.1" BBL	STX Plain	Black	6376-185-411	6376-185-412	6377-185-411	6377-185-412	6378-185-411	6378-185-412	6379-185-411	6379-185-412
Beretta 92F, 92FS, 92G, 96, 96G 4.9" BBL	STX Plain	Black	6376-73-411	6376-73-412	6377-73-411	6377-73-412	6378-73-411	6378-73-412	6379-73-411	6379-73-412
Colt Government 1911 5" BBL	STX Plain	Black	6376-53-411	6376-53-412	6377-53-411	6377-53-412	6378-53-411	6378-53-412	6379-53-411	6379-53-412
FN FNS 9mm, .40 4" BBL	STX Plain	Black	6376-266-411	6376-266-412	6377-266-411	6377-266-412	6378-266-411	6378-266-412	6379-266-411	6379-266-412
FN FNS .40, ITI w/M3, TLR-1, SureFire X200/X300 5" BBL	STX Plain	Black	6376-2672-411	6376-2672-412	6377-2672-411	6377-2672-412	6378-2672-411	6378-2672-412	6379-2672-411	6379-2672-412
Glock 17, 22 4.5" BBL	STX Plain	Black	6376-83-411	6376-83-412	6377-83-411	6377-83-412	6378-83-411	6378-83-412	6379-83-411	6379-83-412
Glock 17, 22, w/ ITI M3 TLR-1, TLR-1HL, SureFire X200/ X300/X300U 4.5" BBL	STX Plain	Black	6376-832-411	6376-832-412	6377-832-411	6377-832-412	6378-832-411	6378-832-412	6379-832-411	6379-832-412
Glock 19, 23, 36 4" BBL	STX Plain	Black	6376-283-411	6376-283-412	6377-283-411	6377-283-412	6378-283-411	6378-283-412	6379-283-411	6379-283-412
Glock 19, 23 w/ ITI M3, TLR-1, TLR-1HL, SureFire X200/X300/X300U 4" BBL	STX Plain	Black	6376-2832-411	6376-2832-412	6377-2832-411	6377-2832-412	6378-2832-411	6378-2832-412	6379-2832-411	6379-2832-412
Glock 20, 21 4.6" BBL	STX Plain	Black	6376-383-411	6376-383-412	6377-383-411	6377-383-412	6378-383-411	6378-383-412	6379-383-411	6379-383-412
Glock 20, 21 w/ ITI M3, TLR-1, TLR-1HL, SureFire X200/X300/X300U 4.6" BBL	STX Plain	Black	6376-3832-411	6376-3832-412	6377-3832-411	6377-3832-412	6378-3832-411	6378-3832-412	6379-3832-411	6379-3832-412
Glock 26, 27 3.78" BBL	STX Plain	Black	6376-183-411	6376-183-412	6377-183-411	6377-183-412	6378-183-411	6378-183-412	6379-183-411	6379-183-412
Glock 29, 30 3.5" BBL	STX Plain	Black	6376-483-411	6376-483-412	6377-483-411	6377-483-412	6378-483-411	6378-483-412	6379-483-411	6379-483-412
Glock 30S 3.78" BBL	STX Plain	Black	6376-485-411	6376-485-412	6377-485-411	6377-485-412	6378-485-411	6378-485-412	6379-485-411	6379-485-412
Glock 34, 35 5.32" BBL	STX Plain	Black	6376-683-411	6376-683-412	6377-683-411	6377-683-412	6378-683-411	6378-683-412	6379-683-411	6379-683-412
Glock 34, 35 w/ ITI M3, TLR-1, TLR-1HL, SureFire X200/X300/X300U 5.32" BBL	STX Tactical	Black	6376-6832-411	6376-6832-412	6377-6832-411	6377-6832-412	6378-6832-411	6378-6832-412	6379-6832-411	6379-6832-412
Glock 37 4.5" BBL	STX Plain	Black	6376-783-411	6376-783-412	6377-783-411	6377-783-412	6378-783-411	6378-783-412	6379-783-411	6379-783-412

How to Order
Duty Holsters
Duty Accessories
Tactical Holsters
Tactical Accessories
Duty Bats
QAS
Speed Loaders
Light Systems
Concealment Holsters
Concealment Accessories
Competition
Apparel
Sales Support
Index/ Price List

Concealment Holsters

6376/6377/6378/6379 ALS® HOLSTERS FOR: PISTOLS (continued)

How to Order	Duty Holsters	GUN DESCRIPTION	FINISH	COLOR	6376		6377		6378		6379	
					RIGHT	LEFT	RIGHT	LEFT	RIGHT	LEFT	RIGHT	LEFT
	Duty Accessories	Glock 39 4.5" BBL	STX Plain	Black	6376-883-411	6376-883-412	6377-883-411	6377-883-412	6378-883-411	6378-883-412	6379-883-411	6379-883-412
	Duty Accessories	Glock 41 5.31"	STX Plain	Black	6376-683-411	6376-683-412	6377-683-411	6377-683-412	6378-683-411	6378-683-412	6379-683-411	6379-683-412
	Tactical Holsters	Heckler & Koch P30 3.9" BBL	STX Plain	Black	6376-295-411	6376-295-412	6377-295-411	6377-295-412	6378-295-411	6378-295-412	6379-295-411	6379-295-412
	Tactical Accessories	Heckler & Koch P30 9/40 w/ ITI M3, TLR-1, TLR-1HL SureFire X200/X300/X300U 3.78" BBL	STX Plain	Black	6376-2952-411	6376-2952-412	6377-2952-411	6377-2952-412	6378-2952-411	6378-2952-412	6379-2952-411	6379-2952-412
	Tactical Accessories	Heckler & Koch P30L 4.44" BBL	STX Plain	Black	6376-395-411	6376-395-412	6377-395-411	6377-395-412	6378-395-411	6378-395-412	6379-395-411	6379-395-412
	Duty Belts	Heckler & Koch P30L 9/40 w/ ITI M3, TLR-1, TLR-1HL SureFire X200/X300/X300U 4.45" BBL	STX Plain	Black	6376-3952-411	6376-3952-412	6377-3952-411	6377-3952-412	6378-3952-411	6378-3952-412	6379-3952-411	6379-3952-412
	OAS	Heckler & Koch P2000 3.5" BBL	STX Plain	Black	6376-97-411	6376-97-412	6377-97-411	6377-97-412	6378-97-411	6378-97-412	6379-97-411	6379-97-412
	Speed Loaders	Heckler & Koch USP 9C, 40C 4.25" BBL	STX Plain	Black	6376-291-411	6376-291-412	6377-291-411	6377-291-412	6378-291-411	6378-291-412	6379-291-411	6379-291-412
	Light Systems	Heckler & Koch USP 9mm, .40 4.13" BBL	STX Plain	Black	6376-91-411	6376-91-412	6377-91-411	6377-91-412	6378-91-411	6378-91-412	6379-91-411	6379-91-412
	Light Systems	Kimber 1911 Pro Carry 4" BBL	STX Plain	Black	6376-52-411	6376-52-412	6377-52-411	6377-52-412	6378-52-411	6378-52-412	6379-52-411	6379-52-412
	Concealment Holsters	Ruger LCR .38 special 1.875" BBL	STX Plain	Black	6376-190-411	6376-190-412	6377-190-411	6377-190-412	6378-190-411	6378-190-412	6379-190-411	6379-190-412
	Concealment Holsters	Sig Sauer P220, P226 4.41" BBL	STX Plain	Black	6376-77-411	6376-77-412	6377-77-411	6377-77-412	6378-77-411	6378-77-412	6379-77-411	6379-77-412
	Concealment Accessories	Sig Sauer P220R DAK, P226R DAK w/ Bobbed Hammer; P220R DA/SA, P226R DA/SA w/ Full Size Hammer 4.41" BBL	STX Plain	Black	6376-477-411	6376-477-412	6377-477-411	6377-477-412	6378-477-411	6378-477-412	6379-477-411	6379-477-412
	Competition	Sig Sauer P220R, P226R w/ ITI M3 TLR-1, TLR-1HL, SureFire X200/X300 w/ Accessory Rails 4.41" BBL	STX Plain	Black	6376-7742-411	6376-7742-412	6377-7742-411	6377-7742-412	6378-7742-411	6378-7742-412	6379-7742-411	6379-7742-412
	Apparel	Sig Sauer P225 3.86" BBL	STX Plain	Black	6376-79-411	6376-79-412	6377-79-411	6377-79-412	6378-79-411	6378-79-412	6379-79-411	6379-79-412
	Apparel	Sig Sauer P226R MK25 4.41" BBL	STX Plain	Black	6376-477-411	6376-477-412	6377-477-411	6377-477-412	6378-477-411	6378-477-412	6379-477-411	6379-477-412
	Sales Support	Sig Sauer P226R Elite 4.41" BBL	STX Plain	Black	6376-477-411	6376-477-412	6377-477-411	6377-477-412	6378-477-411	6378-477-412	6379-477-411	6379-477-412
	Index/Price List											

Concealment Holsters

6376/6377/6378/6379 ALS® HOLSTERS FOR: PISTOLS (continued)

GUN DESCRIPTION	FINISH	COLOR	6376		6377		6378		6379	
			RIGHT	LEFT	RIGHT	LEFT	RIGHT	LEFT	RIGHT	LEFT
Sig Sauer P228, P229 3.9" BBL	STX Plain	Black	6376-74-411	6376-74-412	6377-74-411	6377-74-412	6378-74-411	6378-74-412	6379-74-411	6379-74-412
Sig Sauer P229R DAK w/ Bobbed Hammer; P229R DA/SA w/ Full Size Hammer 3.9" BBL	STX Plain	Black	6376-447-411	6376-447-412	6377-447-411	6377-447-412	6378-447-411	6378-447-412	6379-447-411	6379-447-412
Sig Sauer P229R DAK DA/SA w/ ITI M3, Streamlight TLR-1, TLR-1HL, SureFire X200/X300/X300U 3.9" BBL	STX Plain	Black	6376-7442-411	6367-7442-412	6377-7442-411	6367-7442-412	6378-7442-411	6367-7442-412	6379-7442-411	6367-7442-412
Sig Sauer P239 9mm 3.5" BBL	STX Plain	Black	6376-75-411	6376-75-412	6377-75-411	6377-75-412	6378-75-411	6378-75-412	6379-75-411	6379-75-412
Sig Sauer P239 .40 3.6" BBL	STX Plain	Black	6376-754-411	6376-754-412	6377-754-411	6377-754-412	6378-754-411	6378-754-412	6379-754-411	6379-754-412
Sig Sauer P250 9mm, .40, .45 4.7" BBL	STX Plain	Black	6376-450-411	6376-450-412	6377-450-411	6377-450-412	6378-450-411	6378-450-412	6379-450-411	6379-450-412
Sig Sauer P250 Compact 9mm, .40, .45 3.9" BBL	STX Plain	Black	6376-750-411	6376-750-412	6377-750-411	6377-750-412	6378-750-411	6378-750-412	6379-750-411	6379-750-412
Sig Sauer SP2022 3.87" BBL	STX Plain	Black	6376-278-411	6376-278-412	6377-278-411	6377-278-412	6378-278-411	6378-278-412	6379-278-411	6379-278-412
Smith & Wesson M&P 9C 3.375" BBL	STX Plain	Black	6376-319-411	6376-319-412	6377-319-411	6377-319-412	6378-319-411	6378-319-412	6379-319-411	6379-319-412
Smith & Wesson M&P 9mm, .40, .22LR 4.25" BBL	STX Plain	Black	6376-219-411	6376-219-412	6377-219-411	6377-219-412	6378-219-411	6378-219-412	6379-219-411	6379-219-412
Smith & Wesson M&P 9mm, .40, w/ ITI M3, TLR-1, TLR-1HL, SureFire X200/X300/X300U 4.25" BBL	STX Plain	Black	6376-2192-411	6376-2192-412	6377-2192-411	6377-2192-412	6378-2192-411	6378-2192-412	6379-2192-411	6379-2192-412
Smith & Wesson M&P 45C w/o Thumb Safety w/ITI M3, TLR-1, SureFire X200, X300 4" BBL	STX Plain	Black	6376-9192-411	6376-9192-412	6377-9192-411	6377-9192-412	6378-9192-411	6378-9192-412	6379-9192-411	6379-9192-412
Smith & Wesson M&P 45C w/ & w/o Thumb Safety w/ITI M3, TLR-1, TLR-1HL SureFire X200, X300 4" BBL	STX Plain	Black	6376-9202-411	6376-9202-412	6377-9202-411	6377-9202-412	6378-9202-411	6378-9202-412	6379-9202-411	6379-9202-412
Smith & Wesson M&P 45C w/o Thumb Safety 4" BBL	STX Plain	Black	6376-919-411	6376-919-412	6377-919-411	6377-919-412	6378-919-411	6378-919-412	6379-919-411	6379-919-412
Smith & Wesson M&P 45C w/ Thumb Safety 4" BBL	STX Plain	Black	6376-920-411	6376-920-412	6377-920-411	6377-920-412	6378-920-411	6378-920-412	6379-920-411	6379-920-412
Smith & Wesson M&P .45 w/ & w/o Manual Thumb Safety 4.5" BBL	STX Plain	Black	6376-419-411	6376-419-412	6377-419-411	6377-419-412	6378-419-411	6378-419-412	6379-419-411	6379-419-412

How to Order
Duty Holsters
Duty Accessories
Tactical Holsters
Tactical Accessories
Duty Belts
DAS
Speed Loaders
Light Systems
Concealment Holsters
Concealment Accessories
Competition
Apparel
Sales Support
Index/Price List

Concealment Holsters

6376/6377/6378/6379 ALS® HOLSTERS FOR: PISTOLS (continued)

How to Order	Duty Holsters	GUN DESCRIPTION	FINISH	COLOR	6376		6377		6378		6379	
					RIGHT	LEFT	RIGHT	LEFT	RIGHT	LEFT	RIGHT	LEFT
Duty Accessories		Smith & Wesson M&P .45 w/o Thumb Safety w/ITI M3, TLR-1, TLR-1HL, SureFire X200, X300 4.5" BBL	STX Plain	Black	6376-4192-411	6376-4192-412	6377-4192-411	6377-4192-412	6378-4192-411	6378-4192-412	6379-4192-411	6379-4192-412
Tactical Holsters		Smith & Wesson M&P .45 w/ & w/o Thumb Safety w/ITI M3, TLR-1, SureFire X200, X300 4.5" BBL	STX Plain	Black	6376-5192-411	6376-5192-412	6377-5192-411	6377-5192-412	6378-5192-411	6378-5192-412	6379-5192-411	6379-5192-412
Tactical Accessories		Smith & Wesson M&P .45, w/ Manual Thumb Safety 4.5" BBL	STX Plain	Black	6376-519-411	6376-519-412	6377-519-411	6377-519-412	6378-519-411	6378-519-412	6379-519-411	6379-519-412
Duty Belts		Smith & Wesson M&P SHIELD 9mm 3.1" BBL	STX Plain	Black	6376-179-411	6376-179-412	6377-179-411	6377-179-412	6378-179-411	6378-179-412	6379-179-411	6379-179-412
OAS		Smith & Wesson 5946, 5943 DAO w/o Rails 4" BBL	STX Plain	Black	6376-320-411	6376-320-412	6377-320-411	6377-320-412	6378-320-411	6378-320-412	6379-320-411	6379-320-412
Speed Loaders		Sphinx SDP Sub Compact 3.1" BBL	STX Plain	Black	6376-285-411	6376-285-412	6377-285-411	6377-285-412	6378-285-411	6378-285-412	6379-285-411	6379-285-412
Light Systems		Springfield Army XD(M) 9mm 3.8" BBL	STX Plain	Black	6376-148-411	6376-148-412	6377-148-411	6377-148-412	6378-148-411	6378-148-412	6379-148-411	6379-148-412
Concealment Holsters		Springfield Army XD 9mm, .40, .45 4" BBL	STX Plain	Black	6376-148-411	6376-148-412	6377-148-411	6377-148-412	6378-148-411	6378-148-412	6379-148-411	6379-148-412
		Springfield Army XD(M) 9mm 4.5" BBL	STX Plain	Black	6376-145-411	6376-145-412	6377-145-411	6377-145-412	6378-145-411	6378-145-412	6379-145-411	6379-145-412
Concealment Accessories		Springfield Army XD(M) .40 4.5" BBL	STX Plain	Black	6376-146-411	6376-146-412	6377-146-411	6377-146-412	6378-146-411	6378-146-412	6379-146-411	6379-146-412
		Springfield Army Operator 1911-A1 w/ Picatinny Light Rail 5" BBL	STX Plain	Black	6376-56-411	6376-56-412	6377-56-411	6377-56-412	6378-56-411	6378-56-412	6379-56-411	6379-56-412
Competition		Walther P99 4" BBL	STX Plain	Black	6376-84-411	6376-84-412	6377-84-411	6377-84-412	6378-84-411	6378-84-412	6379-84-411	6379-84-412
Apparel		ALS Guard		Black	6006-1-21	6006-1-22						

Concealment Holsters

6376/6377/6378/6379 ALS® HOLSTERS FOR: REVOLVERS



PATENT
PENDING

6376 BELT SLIDE



PATENT
PENDING

6377 BELT LOOP



PATENT
PENDING

**6378 PADDLE &
BELT LOOP COMBO**



PATENT
PENDING

6379 BELT CLIP

FEATURES

- ▶ ALS® (Automatic Locking System) secures weapon once holstered; simple straight up draw once all releases are deactivated
- ▶ Slim and low profile design for improved concealment
- ▶ Low-ride design for ease of draw
- ▶ Optional ALS® Guard available for increased security
- ▶ Available in STX finishes

Model 6377 is available in seven belt loop sizes:
Sample Codes:
6377-01-411 1.5" Belt Slots w/ Cut-outs for 1.75" Belt Slots
6377-01-411-150 1.5" Belt Slots
6377-01-411-175 1.75" Belt Slots
6377-01-411-50 2" Belt Slots
6377-01-411-225 2.25" Belt Slots
6377-01-411-DM 1.5" Belt Slots w/ Cut-outs for 1.75", 2" and 2.25" Belt Slots w/ 1" Drop
6377-01-411-225DM 2.25" Belt Slots w/ 1" Drop



GUN DESCRIPTION	FINISH	COLOR	6376		6377		6378		6379	
			RIGHT	LEFT	RIGHT	LEFT	RIGHT	LEFT	RIGHT	LEFT
Ruger LCR .38 Special 1.875" BBL	STX Plain	Black	6376-01-411	6376-01-412	6377-01-411	6377-01-412	6378-01-411	6378-01-412	6379-01-411	6379-01-412
Smith & Wesson 31, 34, 36, 36LS, 37, 60, 60LS, 38HL, 49HL, 649HL, Small J frame or similar 2" BBL	STX Plain	Black	6376-01-411	6376-01-412	6377-01-411	6377-01-412	6378-01-411	6378-01-412	6379-01-411	6379-01-412

How to Order
Duty Holsters
Duty Accessories
Tactical Holsters
Tactical Accessories
Duty Belts
QAS
Speed Loaders
Light Systems
Concealment Holsters
Concealment Accessories
Competition
Apparel
Sales Support
Index/Price List

Concealment Holsters

7287 7TS™ SLS BELT SLIDE HOLSTER FOR: PISTOLS



FEATURES

- ▶ Features a unique rotating hood design and semi-hi-ride position with slightly forward cant
- ▶ Rides close to the body, aiding in concealment and weapon retention
- ▶ Injection-molded belt loop is user adjustable for cant and can be worn crossdraw
- ▶ Constructed of SafariSeven™, a proprietary nylon blend that is completely non-abrasive to a firearm's finish
- ▶ Raised stand-off surfaces in holster's interior creates air space around the weapon allowing dirt and moisture to quickly clear any contact with the firearm
- ▶ Very high heat and low cold tolerances structurally sound from 300° F to -50° F

GUN DESCRIPTION	FINISH	COLOR	RIGHT	LEFT
Beretta 92F, 92FS, 92G, 96, 96G 4.9" BBL	SafariSeven SafariSeven	Black FDE Brown	7287-73-411 7287-73-551	7287-73-412 7287-73-552
Glock 17, 22 4.5" BBL	SafariSeven SafariSeven SafariSeven Basket	Black FDE Brown Black	7287-83-411 7287-83-551 7287-83-481	7287-83-412 7287-83-552 7287-83-482
Glock 17, 22 w/ITI M3, TLR-1, TLR-1HL, SureFire X200/X300/X300U 4.5" BBL	SafariSeven Plain SafariSeven Plain SafariSeven Basket SafariSeven Hi-Gloss	Black FDE Brown Black Black	7287-832-411 7287-832-551 7287-832-481 7287-832-491	7287-832-412 7287-832-552 7287-832-482 7287-832-492
Glock 17,22 w/ XC-1 Surefire Light 4.5" BBL	SafariSeven Plain SafariSeven Plain SafariSeven Basket SafariSeven Hi-Gloss	Black FDE Brown Black Black	7287-8322-411 7287-8322-551 7287-8322-481 7287-8322-491	7287-8322-412 7287-8322-552 7287-8322-482 7287-8322-492
Glock 19, 23 4" BBL	SafariSeven Plain SafariSeven Plain SafariSeven Basket	Black FDE Brown Black	7287-283-411 7287-283-551 7287-283-481	7287-283-412 7287-283-552 7287-283-482
Glock 19, 23 w/ITI M3, TLR-1, TLR-1HL, SureFire X200/X300/X300U 4.5" BBL	SafariSeven Plain SafariSeven Plain SafariSeven Basket SafariSeven Hi-Gloss	Black FDE Brown Black Black	7287-2832-411 7287-2832-551 7287-2832-481 7287-2832-491	7287-2832-412 7287-2832-552 7287-2832-482 7287-2832-492
Glock 19,23 w/ XC-1 Surefire Light 4" BBL	SafariSeven Plain SafariSeven Plain SafariSeven Basket SafariSeven Hi-Gloss	Black FDE Brown Black Black	7287-28322-411 7287-28322-551 7287-28322-481 7287-28322-491	7287-28322-412 7287-28322-552 7287-28322-482 7287-28322-492
Glock 20/21 4.6" BBL	SafariSeven Plain SafariSeven Plain SafariSeven Basket SafariSeven Hi-Gloss	Black FDE Brown Black Black	7287-383-411 7287-383-551 7287-383-481 7287-383-491	7287-383-412 7287-383-552 7287-383-482 7287-383-492
Glock 20, 21 w/ITI M3, TLR-1, TLR-1HL, SureFire X200/X300/X300U 4.6" BBL	SafariSeven Plain SafariSeven Plain SafariSeven Basket SafariSeven Hi-Gloss	Black FDE Brown Black Black	7287-3832-411 7287-3832-551 7287-3832-481 7287-3832-491	7287-3832-412 7287-3832-552 7287-3832-482 7287-3832-492
Glock 26, 27 3.5" BBL	SafariSeven Plain SafariSeven Plain	Black FDE Brown	7287-183-411 7287-183-551	7287-183-412 7287-183-552
Heckler & Koch P30 3.78" BBL	SafariSeven Plain SafariSeven Plain	Black FDE Brown	7287-295-411 7287-295-551	7287-295-412 7287-295-552
Heckler & Koch P2000 DAO 3.5" BBL	SafariSeven Plain SafariSeven Plain	Black FDE Brown	7287-197-411 7287-197-551	7287-197-412 7287-197-552
Heckler & Koch P2000 DA/SA 3.5" BBL	SafariSeven Plain SafariSeven Plain	Black FDE Brown	7287-397-411 7287-397-551	7287-397-412 7287-397-552
Heckler & Koch USP 9C/40C DAO 4.25" BBL	SafariSeven Plain SafariSeven Plain	Black FDE Brown	7287-291-411 7287-291-551	7287-291-412 7287-291-552

Concealment Holsters

7287 7TS™ SLS BELT SLIDE HOLSTER FOR: PISTOLS (continued)

GUN DESCRIPTION	FINISH	COLOR	RIGHT	LEFT
Heckler & Koch USP 9C/40C DA/SA 4.25" BBL	SafariSeven Plain	Black	7287-391-411	7287-391-412
	SafariSeven Plain	FDE Brown	7287-391-551	7287-391-552
Heckler & Koch VP9 4.09" BBL	SafariSeven Plain	Black	7287-593-411	7287-593-412
	SafariSeven Plain	FDE Brown	7287-593-551	7287-593-552
Ruger American 9mm, .40 4.5" BBL	SafariSeven Plain	Black	7287-167-411	7287-167-412
	SafariSeven Plain	FDE Brown	7287-167-551	7287-167-552
Ruger .45ASP 4.5" BBL	SafariSeven Plain	Black	7287-168-411	7287-168-412
	SafariSeven Plain	FDE Brown	7287-168-551	7287-168-552
Sig Sauer P220, P226, P220R, P226R, P226R MK25 9mm, .40 4.41" BBL P227 R3 .45 3.9" BBL	SafariSeven Plain	Black	7287-477-411	7287-477-412
	SafariSeven Plain	FDE Brown	7287-477-551	7287-477-552
Sig Sauer P226, P226R, P226R MK 9mm, .40 w/ITI M3, TLR-1, TLR-1HL, Surefire X200, X300, X300U 4.41" BBL	SafariSeven Plain	Black	7287-4772-411	7287-4772-412
	SafariSeven Plain	FDE Brown	7287-4772-551	7287-4772-552
	SafariSeven Basket	Black	7287-4772-481	7287-4772-482
	SafariSeven Hi-Gloss	Black	7287-4772-491	7287-4772-492
Sig Sauer P220, P220R w/ITI M3, TLR-1, TLR-1HL, Surefire X200, X300, X300U 4.41" BBL	SafariSeven Plain	Black	7287-7702-411	7287-7702-412
	SafariSeven Plain	FDE Brown	7287-7702-551	7287-7702-552
	SafariSeven Basket	Black	7287-7702-481	7287-7702-482
	SafariSeven Hi-Gloss	Black	7287-7702-491	7287-7702-492
Sig Sauer P227, P227 R3 w/ITI M3, TLR-1, TLR-1HL, Surefire X200, X300, X300U 3.9" BBL	SafariSeven Plain	Black	7287-6772-411	7287-6772-412
	SafariSeven Plain	FDE Brown	7287-6772-551	7287-6772-552
	SafariSeven Basket	Black	7287-6772-481	7287-6772-482
	SafariSeven Hi-Gloss	Black	7287-6772-491	7287-6772-492
Sig Sauer P229R DAK, P229R E2 9mm, 3.9" BBL	SafariSeven Plain	Black	7287-474-411	7287-474-412
	SafariSeven Plain	FDE Brown	7287-474-551	7287-474-552
Sig Sauer P229, P229DAK, P229R 9mm w/ITI M3, TLR-1, TLR-1HL, Surefire X200, X300, X300U 3.9" BBL	SafariSeven Plain	Black	7287-4742-411	7287-4742-412
	SafariSeven Plain	FDE Brown	7287-4742-551	7287-4742-552
	SafariSeven Basket	Black	7287-4742-481	7287-4742-482
	SafariSeven Hi-Gloss	Black	7287-4742-491	7287-4742-492
Sig Sauer P229, P229R, .40 3.9" BBL	SafariSeven Plain	Black	7287-447-411	7287-447-412
	SafariSeven Plain	FDE Brown	7287-447-551	7287-447-552
Sig Sauer P229, P229R .40 w/ITI M3, TLR-1, TLR-1HL, Surefire X200, X300, X300U 3.9" BBL	SafariSeven Plain	Black	7287-4472-411	7287-4472-412
	SafariSeven Plain	FDE Brown	7287-4472-551	7287-4472-552
	SafariSeven Basket	Black	7287-4472-481	7287-4472-482
	SafariSeven Hi-Gloss	Black	7287-4472-491	7287-4472-492
Sig Sauer P320 Full Size 9mm, .40 4.7" BBL	SafariSeven Plain	Black	7287-450-411	7287-450-412
	SafariSeven Plain	FDE Brown	7287-450-551	7287-450-552
Sig Sauer P320 Full Size 9mm, .40 w/ITI M3, TLR-1, TLR-1HL, Surefire X200/X300/X300U 4.7" BBL	SafariSeven Plain	Black	7287-4502-411	7287-4502-412
	SafariSeven Plain	FDE Brown	7287-4502-551	7287-4502-552
	SafariSeven Basket	Black	7287-4502-481	7287-4502-482
	SafariSeven Hi-Gloss	Black	7287-4502-491	7287-4502-492
Sig Sauer P320 Compact & Carry 9mm, .40 3.9" BBL	SafariSeven Plain	Black	7287-750-411	7287-750-412
	SafariSeven Plain	FDE Brown	7287-750-551	7287-750-552
Sig Sauer P320 Compact & Carry 9mm, .40 w/ITI M3, TLR-1, Surefire X200/X300/X300U 4.7" BBL	SafariSeven Plain	Black	7287-7502-411	7287-7502-412
	SafariSeven Plain	FDE Brown	7287-7502-551	7287-7502-552
	SafariSeven Basket	Black	7287-7502-481	7287-7502-482
	SafariSeven Hi-Gloss	Black	7287-7502-491	7287-7502-492
Sig Sauer P320 Full Size .45 3.9" BBL	SafariSeven Plain	Black	7287-451-411	7287-451-412
	SafariSeven Plain	FDE Brown	7287-451-551	7287-451-552

How to Order
Duty Holsters
Duty Accessories
Tactical Holsters
Tactical Accessories
Duty Bats
QAS
Speed Loaders
Light Systems
Concealment Holsters
Concealment Accessories
Competition
Apparel
Sales Support
Index/Price List

Concealment Holsters

7367 7TS™ ALS®/SLS BELT SLIDE HOLSTER FOR: PISTOLS

FEATURES

- ▶ ALS® (Automatic Locking System) secures weapon once holstered, simple straight up draw once release is deactivated
- ▶ SLS (Self Locking System) Rotating Hood
- ▶ Optional Sentry
- ▶ A proprietary nylon blend that is completely non-abrasive to a firearm's finish
- ▶ Raised stand-off surfaces in the interior of the holster to create air space around the weapon allowing dirt and moisture to quickly clear any contact with the firearm
- ▶ Very high heat and low cold tolerances structurally sound from 300° F to -50° F
- ▶ Can be submerged in water indefinitely and still maintain shape and function
- ▶ Injection-molded belt loop is user adjustable for cant and can be worn cross draw
- ▶ Available for 1.5" (38mm), 1.75" (45mm), 2" (50mm) or 2.25" (58mm) belt slots; please specify
- ▶ Matte finish designed to decrease reflection and can be maintained with a simple scouring pad



GUN DESCRIPTION	FINISH	COLOR	RIGHT	LEFT
Beretta 92F, 92FS, 92G, 96, 96G 4.9" BBL	SafariSeven Plain	Black	7367-73-411	7367-73-412
	SafariSeven Plain	FDE Brown	7367-73-551	7367-73-552
Glock 17, 22 4.5" BBL	SafariSeven Plain	Black	7367-83-411	7367-83-412
	SafariSeven Plain	FDE Brown	7367-83-551	7367-83-552
	SafariSeven Basket	Black	7367-83-481	7367-83-482
Glock 17, 22 w/ ITI M3, TLR-1, TLR-1HL, SureFire X200/X300/X300U 4.5" BBL	SafariSeven Plain	Black	7367-832-411	7367-832-412
	SafariSeven Plain	FDE Brown	7367-832-551	7367-832-552
	SafariSeven Basket	Black	7367-832-481	7367-832-482
	SafariSeven Hi-Gloss	Black	7367-832-491	7367-832-492
Glock 17,22 w/ XC-1 Surefire Light 4.5" BBL	SafariSeven Plain	Black	7367-8322-411	7367-8322-412
	SafariSeven Plain	FDE Brown	7367-8322-551	7367-8322-552
	SafariSeven Basket	Black	7367-8322-481	7367-8322-482
	SafariSeven Hi-Gloss	Black	7367-8322-491	7367-8322-492
Glock 19, 23 4" BBL	SafariSeven Plain	Black	7367-283-411	7367-283-412
	SafariSeven Plain	FDE Brown	7367-283-551	7367-283-552
	SafariSeven Basket	Black	7367-283-481	7367-283-482
Glock 19, 23 w/ ITI M3, TLR-1, TLR-1HL, SureFire X200/X300/X300U 4" BBL	SafariSeven Plain	Black	7367-2832-411	7367-2832-412
	SafariSeven Plain	FDE Brown	7367-2832-551	7367-2832-552
	SafariSeven Basket	Black	7367-2832-481	7367-2832-482
	SafariSeven Hi-Gloss	Black	7367-2832-491	7367-2832-492
Glock 19,23 w/ XC-1 Surefire Light 4" BBL	SafariSeven Plain	Black	7367-28322-411	7367-28322-412
	SafariSeven Plain	FDE Brown	7367-28322-551	7367-28322-552
	SafariSeven Basket	Black	7367-28322-481	7367-28322-482
	SafariSeven Hi-Gloss	Black	7367-28322-491	7367-28322-492
Glock 20/21 4.6" BBL	SafariSeven Plain	Black	7367-383-411	7367-383-412
	SafariSeven Plain	FDE Brown	7367-383-551	7367-383-552
	SafariSeven Basket	Black	7367-383-481	7367-383-482
	SafariSeven Hi-Gloss	Black	7367-383-491	7367-383-492
Glock 20, 21 w/ITI M3, TLR-1, TLR-1HL, SureFire X200/X300/X300U 4.6" BBL	SafariSeven Plain	Black	7367-3832-411	7367-3832-412
	SafariSeven Plain	FDE Brown	7367-3832-551	7367-3832-552
	SafariSeven Basket	Black	7367-3832-481	7367-3832-482
	SafariSeven Hi-Gloss	Black	7367-3832-491	7367-3832-492
Heckler & Koch P30 3.78" BBL	SafariSeven Plain	Black	7367-295-411	7367-295-412
	SafariSeven Plain	FDE Brown	7367-295-551	7367-295-552
Heckler & Koch P2000 DAO 3.5" BBL	SafariSeven Plain	Black	7367-197-411	7367-197-412
	SafariSeven Plain	FDE Brown	7367-197-551	7367-197-552
Heckler & Koch P2000 DA/SA 3.5" BBL	SafariSeven Plain	Black	7367-397-411	7367-397-412
	SafariSeven Plain	FDE Brown	7367-397-551	7367-397-552
Heckler & Koch USP 9C/40C DAO 4.25" BBL	SafariSeven Plain	Black	7367-291-411	7367-291-412
	SafariSeven Plain	FDE Brown	7367-291-551	7367-291-552

How to
Order
Duty
Holsters
Duty
Accessories
Tactical
Holsters
Tactical
Accessories
Duty
Belts
QAS
Speed
Loaders
Light
Systems
Concealment
Holsters
Concealment
Accessories
Competition
Apparel
Sales
Support
Index/
Price
List

Concealment Holsters

7367 7TS™ ALS®/SLS BELT SLIDE HOLSTER FOR: PISTOLS (continued)

How to Order
Duty Holsters
Duty Accessories
Tactical Holsters
Tactical Accessories
Duty Belts
OAS
Speed Loaders
Light Systems
Concealment Holsters
Concealment Accessories
Competition
Apparel
Sales Support
Index/Price List

GUN DESCRIPTION	FINISH	COLOR	RIGHT	LEFT
Heckler & Koch USP 9C/40C DA/SA 4.25" BBL	SafariSeven Plain SafariSeven Plain	Black FDE Brown	7367-391-411 7367-391-551	7367-391-412 7367-391-552
Heckler & Koch VP9 4.09" BBL	SafariSeven Plain SafariSeven Plain	Black FDE Brown	7367-593-411 7367-593-551	7367-593-412 7367-593-552
Ruger American 9mm, .40 4.5" BBL	SafariSeven Plain SafariSeven Plain	Black FDE Brown	7367-167-411 7367-167-551	7367-167-412 7367-167-552
Ruger .45 ASP 4.5" BBL	SafariSeven Plain SafariSeven Plain	Black FDE Brown	7367-168-411 7367-168-551	7367-168-412 7367-168-552
Sig Sauer P220, P220R w/ITI M3, TLR-1, TLR-1HL, Surefire X200, X300, X300U 4.41" BBL	SafariSeven Plain SafariSeven Plain SafariSeven Basket SafariSeven Hi-Gloss	Black FDE Brown Black Black	7367-7702-411 7367-7702-551 7367-7702-481 7367-7702-491	7367-7702-412 7367-7702-552 7367-7702-482 7367-7702-492
Sig Sauer P226, P226R, P226R MK 9mm, .40 w/ITI M3, TLR-1, TLR-1HL, Surefire X200, X300, X300U 4.41" BBL	SafariSeven Plain SafariSeven Plain SafariSeven Basket SafariSeven Hi-Gloss	Black FDE Brown Black Black	7367-4772-411 7367-4772-551 7367-4772-481 7367-4772-491	7367-4772-412 7367-4772-552 7367-4772-482 7367-4772-492
Sig Sauer P227, P227 R3 w/ITI M3,, TLR-1, TLR-1HL Surefire X200, X300, X300U 3.9" BBL	SafariSeven Plain SafariSeven Plain SafariSeven Basket SafariSeven Hi-Gloss	Black FDE Brown Black Black	7367-6772-411 7367-6772-551 7367-6772-481 7367-6772-491	7367-6772-412 7367-6772-552 7367-6772-482 7367-6772-492
Sig Sauer P229R DAK, P229R E2 9mm 3.9" BBL	SafariSeven Plain SafariSeven Plain	Black FDE Brown	7367-474-411 7367-474-551	7367-474-412 7367-474-552
Sig Sauer P229, P229DAK, P229R 9mm w/ITI M3, TLR-1, TLR-1HL, Surefire X200, X300, X300U 3.9" BBL	SafariSeven Plain SafariSeven Plain SafariSeven Basket SafariSeven Hi-Gloss	Black FDE Brown Black Black	7367-4742-411 7367-4742-551 7367-4742-481 7367-4742-491	7367-4742-412 7367-4742-552 7367-4742-482 7367-4742-492
Sig Sauer P229, P229R, .40 3.9" BBL	SafariSeven Plain SafariSeven Plain	Black FDE Brown	7367-447-411 7367-447-551	7367-447-412 7367-447-552
Sig Sauer P229, P229R .40 w/ITI M3, TLR-1, TLR-1HL, Surefire X200, X300, X300U 3.9" BBL	SafariSeven Plain SafariSeven Plain SafariSeven Basket SafariSeven Hi-Gloss	Black FDE Brown Black Black	7367-4472-411 7367-4472-551 7367-4472-481 7367-4472-491	7367-4472-412 7367-4472-552 7367-4472-482 7367-4472-492
Sig Sauer P220, P226, P220R, P226R, P226R MK25 9mm, .40 4.41" BBL, P227 R3 .45 3.9" BBL	SafariSeven Plain SafariSeven Plain	Black FDE Brown	7367-477-411 7367-477-551	7367-477-412 7367-477-552
Sig Sauer P320 Full Size 9mm, .40 4.7" BBL	SafariSeven Plain SafariSeven Plain	Black FDE Brown	7367-450-411 7367-450-551	7367-450-412 7367-450-552
Sig Sauer P320 Full Size 9mm, .40 w/ITI M3, TLR-1, TLR-1HL, Surefire X200/X300/X300U 4.7" BBL	SafariSeven Plain SafariSeven Plain SafariSeven Basket SafariSeven Hi-Gloss	Black FDE Brown Black Black	7367-4502-411 7367-4502-551 7367-4502-481 7367-4502-491	7367-4502-412 7367-4502-552 7367-4502-482 7367-4502-492
Sig Sauer P320 Compact & Carry 9mm, .40 3.9" BBL	SafariSeven Plain SafariSeven Plain	Black FDE Brown	7367-750-411 7367-750-551	7367-750-412 7367-750-552
Sig Sauer P320 Compact & Carry 9mm, .40 w/ITI M3, TLR-1, TLR-1HL, Surefire X200/X300/X300U 4.7" BBL	SafariSeven Plain SafariSeven Plain SafariSeven Basket SafariSeven Hi-Gloss	Black FDE Brown Black Black	7367-7502-411 7367-7502-551 7367-7502-481 7367-7502-491	7367-7502-412 7367-7502-552 7367-7502-482 7367-7502-492

Concealment Holsters

7367 7TS™ ALS®/SLS BELT SLIDE HOLSTER FOR: PISTOLS (continued)

GUN DESCRIPTION	FINISH	COLOR	RIGHT	LEFT
Sig Sauer P320 Full Size .45 3.9" BBL	SafariSeven Plain	Black	7367-451-411	7367-451-412
	SafariSeven Plain	FDE Brown	7367-451-551	7367-451-552
Sig Sauer P320 Full Size .45 w/ ITI M3, TLR-1, TLR-1HL, Surefire X200/X300/X300U 3.9" BBL	SafariSeven Plain	Black	7367-4512-411	7367-4512-412
	SafariSeven Plain	FDE Brown	7367-4512-551	7367-4512-552
	SafariSeven Basket	Black	7367-4512-481	7367-4512-482
	SafariSeven Hi-Gloss	Black	7367-4512-491	7367-4512-492
Sig Sauer P320 Compact & Carry .45 3.9" BBL	SafariSeven Plain	Black	7367-751-411	7367-751-412
	SafariSeven Plain	FDE Brown	7367-751-551	7367-751-552
Sig Sauer P320 Compact & Carry .45 w/ ITI M3, TLR-1, TLR-1HL, Surefire X200/X300/X300U 3.9" BBL	SafariSeven Plain	Black	7367-7512-411	7367-7512-412
	SafariSeven Plain	FDE Brown	7367-7512-551	7367-7512-552
	SafariSeven Basket	Black	7367-7512-481	7367-7512-482
	SafariSeven Hi-Gloss	Black	7367-7512-491	7367-7512-492
Smith & Wesson M&P .45 w/ITI M3, TLR-1, TLR-1HL, Surefire X200, X300, X300U 3.9" BBL	SafariSeven Plain	Black	7367-4192-411	7367-4192-412
	SafariSeven Plain	FDE Brown	7367-4192-551	7367-4192-552
	SafariSeven Basket	Black	7367-4192-481	7367-4192-482
Smith & Wesson M&P 9L, .40L 5" BBL	SafariSeven Plain	Black	7367-819-411	7367-819-412
	SafariSeven Plain	FDE Brown	7367-819-551	7367-819-552
Smith & Wesson M&P 9L, .40L w/ITI M3, TLR-1, TLR-1HL, Surefire X200, X300, X300U 5" BBL	SafariSeven Plain	Black	7367-8192-411	7367-8192-412
	SafariSeven Plain	FDE Brown	7367-8192-551	7367-8192-552
	SafariSeven Basket	Black	7367-8192-481	7367-8192-482
Smith & Wesson M&P 9mm, .40 4.25" BBL	SafariSeven Plain	Black	7367-219-411	7367-219-412
	SafariSeven Plain	FDE Brown	7367-219-551	7367-219-552
Smith & Wesson M&P 9mm, .40 w/ XC-1 Surefire Light 4.25" BBL	SafariSeven Plain	Black	7367-21922-411	7367-21922-412
	SafariSeven Plain	FDE Brown	7367-21922-551	7367-21922-552
	SafariSeven Basket	Black	7367-21922-481	7367-21922-482
	SafariSeven Hi-Gloss	Black	7367-21922-491	7367-21922-492
Smith & Wesson M&P 9/40 w/ ITI M3, TLR-1, TLR-1HL SureFire X200/X300/X300U 4.25" BBL	SafariSeven Plain	Black	7367-2192-411	7367-2192-412
	SafariSeven Plain	FDE Brown	7367-2192-551	7367-2192-552
	SafariSeven Basket	Black	7367-2192-481	7367-2192-482
Smith & Wesson M&P 45 4.5" BBL	SafariSeven Plain	Black	7367-419-411	7367-419-412
	SafariSeven Plain	FDE Brown	7367-419-551	7367-419-552
	SafariSeven Basket	Black	7367-419-481	7367-419-482
Smith & Wesson M&P 45C 4" BBL	SafariSeven Plain	Black	7367-919-411	7367-919-412
	SafariSeven Plain	FDE Brown	7367-919-551	7367-919-552
	SafariSeven Basket	Black	7367-919-481	7367-919-482
Walther P99Q 4" BBL	SafariSeven Plain	Black	7367-384-411	7367-384-412
	SafariSeven Plain	FDE Brown	7367-384-551	7367-384-552
Walther P99Q 5" BBL	SafariSeven Plain	Black	7367-385-411	7367-385-412
	SafariSeven Plain	FDE Brown	7367-385-551	7367-385-552

How to Order
Duty Holsters
Duty Accessories
Tactical Holsters
Tactical Accessories
Duty Bats
QAS
Speed Loaders
Light Systems
Concealment Holsters
Concealment Accessories
Competition
Apparel
Sales Support
Index/Price List

Concealment Holsters

7376/7377/7378/7379 7TS™ ALS® CONCEALMENT HOLSTERS FOR: PISTOLS



PATENTED & PATENT PENDING

7376 BELT SLIDE



PATENTED & PATENT PENDING

7377 BELT LOOP



PATENTED & PATENT PENDING

7378 PADDLE & BELT LOOP COMBO



PATENTED & PATENT PENDING

7379 BELT CLIP

FEATURES

- ▶ ALS® (Automatic Locking System) secures weapon once holstered, simple straight up draw once release is deactivated
- ▶ Open-top design without SLS for quick retrieval of weapon
- ▶ Constructed of SafariSeven™, a proprietary nylon blend that is completely non-abrasive to a firearm's finish
- ▶ Raised stand-off surfaces in the interior of the holster to create air space around the weapon allowing dirt and moisture to quickly clear any contact with the firearm any contact with the firearm
- ▶ Very high heat and low cold tolerances structurally sound from 300° F to -50° F
- ▶ Can be submerged in water indefinitely and still maintain shape and function
- ▶ Matte finish designed to decrease reflection and can be maintained with a simple scouring pad

GUN DESCRIPTION	FINISH	COLOR	7376		7377		7378		7379	
			RIGHT	LEFT	RIGHT	LEFT	RIGHT	LEFT	RIGHT	LEFT
Beretta 92F, 92FS, 92G, 96, 96G 4.9" BBL	SafariSeven Plain	Black	7376-73-411	7376-73-412	7377-73-411	7377-73-412	7378-73-411	7378-73-412	7379-73-411	7379-73-412
	SafariSeven Plain	FDE Brown	7376-73-551	7376-73-552	7377-73-551	7377-73-552	7378-73-551	7378-73-552	7379-73-551	7379-73-552
Glock 17, 22 4.5" BBL	SafariSeven Plain	Black	7376-83-411	7376-83-412	7377-83-411	7377-83-412	7378-83-411	7378-83-412	7379-83-411	7379-83-412
	SafariSeven Plain	FDE Brown	7376-83-551	7376-83-552	7377-83-551	7377-83-552	7378-83-551	7378-83-552	7379-83-551	7379-83-552
	SafariSeven Basket	Black	7376-83-481	7376-83-482	7377-83-481	7377-83-482	7378-83-481	7378-83-482	7379-83-481	7379-83-482
Glock 17, 22 w/ ITI M3, TLR-1, TLR-1HL, SureFire X200/X300/X300U 4.5" BBL	SafariSeven Plain	Black	7376-832-411	7376-832-412	7377-832-411	7377-832-412	7378-832-411	7378-832-412	7379-832-411	7379-832-412
	SafariSeven Plain	FDE Brown	7376-832-551	7376-832-552	7377-832-551	7377-832-552	7378-832-551	7378-832-552	7379-832-551	7379-832-552
	SafariSeven Basket	Black	7376-832-481	7376-832-482	7377-832-481	7377-832-482	7378-832-481	7378-832-482	7379-832-481	7379-832-482
	SafariSeven Hi-Gloss	Black	7376-832-491	7376-832-492	7377-832-491	7377-832-492	7378-832-491	7378-832-492	7379-832-491	7379-832-492
Glock 17,22 w/ XC-1 Surefire Light 4.5" BBL	SafariSeven Plain	Black	7376-8322-411	7376-8322-412	7377-8322-411	7377-8322-412	7378-8322-411	7378-8322-412	7379-8322-411	7379-8322-412
	SafariSeven Plain	FDE Brown	7376-8322-551	7376-8322-552	7377-8322-551	7377-8322-552	7378-8322-551	7378-8322-552	7379-8322-551	7379-8322-552
	SafariSeven Basket	Black	7376-8322-481	7376-8322-482	7377-8322-481	7377-8322-482	7378-8322-481	7378-8322-482	7379-8322-481	7379-8322-482
	SafariSeven Hi-Gloss	Black	7376-8322-491	7376-8322-492	7377-8322-491	7377-8322-492	7378-8322-491	7378-8322-492	7379-8322-491	7379-8322-492
Glock 19, 23 4" BBL	SafariSeven Plain	Black	7376-283-411	7376-283-412	7377-283-411	7377-283-412	7378-283-411	7378-283-412	7379-283-411	7379-283-412
	SafariSeven Plain	FDE Brown	7376-283-551	7376-283-552	7377-283-551	7377-283-552	7378-283-551	7378-283-552	7379-283-551	7379-283-552
	SafariSeven Basket	Black	7376-283-481	7376-283-482	7377-283-481	7377-283-482	7378-283-481	7378-283-482	7379-283-481	7379-283-482
Glock 19, 23 w/ ITI M3, TLR-1, TLR-1HL, SureFire X200/X300/ X300U, 4" BBL	SafariSeven Plain	Black	7376-2832-411	7376-2832-412	7377-2832-411	7377-2832-412	7378-2832-411	7378-2832-412	7379-2832-411	7379-2832-412
	SafariSeven Plain	FDE Brown	7376-2832-551	7376-2832-552	7377-2832-551	7377-2832-552	7378-2832-551	7378-2832-552	7379-2832-551	7379-2832-552
	SafariSeven Basket	Black	7376-2832-481	7376-2832-482	7377-2832-481	7377-2832-482	7378-2832-481	7378-2832-482	7379-2832-481	7379-2832-482
	SafariSeven Hi-Gloss	Black	7376-2832-491	7376-2832-492	7377-2832-491	7377-2832-492	7378-2832-491	7378-2832-492	7379-2832-491	7379-2832-492
Glock 19,23 w/ XC-1 Surefire Light 4" BBL	SafariSeven Plain	Black	7376-28322-411	7376-28322-412	7377-28322-411	7377-28322-412	7378-28322-411	7378-28322-412	7379-28322-411	7379-28322-412
	SafariSeven Plain	FDE Brown	7376-28322-551	7376-28322-552	7377-28322-551	7377-28322-552	7378-28322-551	7378-28322-552	7379-28322-551	7379-28322-552
	SafariSeven Basket	Black	7376-28322-481	7376-28322-482	7377-28322-481	7377-28322-482	7378-28322-481	7378-28322-482	7379-28322-481	7379-28322-482
	SafariSeven Hi-Gloss	Black	7376-28322-491	7376-28322-492	7377-28322-491	7377-28322-492	7378-28322-491	7378-28322-492	7379-28322-491	7379-28322-492
Glock 20, 21 w/ITI M3, TLR-1, TLR-1HL SureFire X200/X300/ X300U, 4.6" BBL	SafariSeven Plain	Black	7376-3832-411	7376-3832-412	7377-3832-411	7377-3832-412	7378-3832-411	7378-3832-412	7379-3832-411	7379-3832-412
	SafariSeven Plain	FDE Brown	7376-3832-551	7376-3832-552	7377-3832-551	7377-3832-552	7378-3832-551	7378-3832-552	7379-3832-551	7379-3832-552
	SafariSeven Basket	Black	7376-3832-481	7376-3832-482	7377-3832-481	7377-3832-482	7378-3832-481	7378-3832-482	7379-3832-481	7379-3832-482
	SafariSeven Hi-Gloss	Black	7376-3832-491	7376-3832-492	7377-3832-491	7377-3832-492	7378-3832-491	7378-3832-492	7379-3832-491	7379-3832-492
Glock 20/21 4.6" BBL	SafariSeven Plain	Black	7376-383-411	7376-383-412	7377-383-411	7377-383-412	7378-383-411	7378-383-412	7379-383-411	7379-383-412
	SafariSeven Plain	FDE Brown	7376-383-551	7376-383-552	7377-383-551	7377-383-552	7378-383-551	7378-383-552	7379-383-551	7379-383-552
	SafariSeven Basket	Black	7376-383-481	7376-383-482	7377-383-481	7377-383-482	7378-383-481	7378-383-482	7379-383-481	7379-383-482
	SafariSeven Hi-Gloss	Black	7376-383-491	7376-383-492	7377-383-491	7377-383-492	7378-383-491	7378-383-492	7379-383-491	7379-383-492
Glock 26, 27 3.5" BBL	SafariSeven Plain	Black	7376-183-411	7376-183-412	7377-183-411	7377-183-412	7378-183-411	7378-183-412	7379-183-411	7379-183-412
	SafariSeven Plain	FDE Brown	7376-183-551	7376-183-552	7377-183-551	7377-183-552	7378-183-551	7378-183-552	7379-183-551	7379-183-552

Concealment Holsters

7376/7377/7378/7379 7TS™ ALS® CONCEALMENT HOLSTERS FOR: PISTOLS (continued)

GUN DESCRIPTION	FINISH	COLOR	7376		7377		7378		7379	
			RIGHT	LEFT	RIGHT	LEFT	RIGHT	LEFT	RIGHT	LEFT
Heckler & Koch P30 3.78" BBL	SafariSeven Plain	Black	7376-295-411	7376-295-412	7377-295-411	7377-295-412	7378-295-411	7378-295-412	7379-295-411	7379-295-412
	SafariSeven Plain	FDE Brown	7376-295-551	7376-295-552	7377-295-551	7377-295-552	7378-295-551	7378-295-552	7379-295-551	7379-295-552
Heckler & Koch P2000 DAO 3.5" BBL	SafariSeven Plain	Black	7376-197-411	7376-197-412	7377-197-411	7377-197-412	7378-197-411	7378-197-412	7379-197-411	7379-197-412
	SafariSeven Plain	FDE Brown	7376-197-551	7376-197-552	7377-197-551	7377-197-552	7378-197-551	7378-197-552	7379-197-551	7379-197-552
Heckler & Koch P2000 DA/SA 3.5" BBL	SafariSeven Plain	Black	7376-397-411	7376-397-412	7377-397-411	7377-397-412	7378-397-411	7378-397-412	7379-397-411	7379-397-412
	SafariSeven Plain	FDE Brown	7376-397-551	7376-397-552	7377-397-551	7377-397-552	7378-397-551	7378-397-552	7379-397-551	7379-397-552
Heckler & Koch USP 9C/40C DAO 4.25" BBL	SafariSeven Plain	Black	7376-291-411	7376-291-412	7377-291-411	7377-291-412	7378-291-411	7378-291-412	7379-291-411	7379-291-412
	SafariSeven Plain	FDE Brown	7376-291-551	7376-291-552	7377-291-551	7377-291-552	7378-291-551	7378-291-552	7379-291-551	7379-291-552
Heckler & Koch USP 9C/40C DA/SA 4.25" BBL	SafariSeven Plain	Black	7376-391-411	7376-391-412	7377-391-411	7377-391-412	7378-391-411	7378-391-412	7379-391-411	7379-391-412
	SafariSeven Plain	FDE Brown	7376-391-551	7376-391-552	7377-391-551	7377-391-552	7378-391-551	7378-391-552	7379-391-551	7379-391-552
Heckler & Koch VP9 4.09" BBL	SafariSeven Plain	Black	7376-593-411	7376-593-412	7377-593-411	7377-593-412	7378-593-411	7378-593-412	7379-593-411	7379-593-412
	SafariSeven Plain	FDE Brown	7376-593-551	7376-593-552	7377-593-551	7377-593-552	7378-593-551	7378-593-552	7379-593-551	7379-593-552
Ruger American 9mm, .40, 4.5" BBL	SafariSeven Plain	Black	7376-167-411	7376-167-412	7377-167-411	7377-167-412	7378-167-411	7378-167-412	7379-167-411	7379-167-412
	SafariSeven Plain	FDE Brown	7376-167-551	7376-167-552	7377-167-551	7377-167-552	7378-167-551	7378-167-552	7379-167-551	7379-167-552
Ruger .45 ASP 4.5" BBL	SafariSeven Plain	Black	7376-168-411	7376-168-412	7377-168-411	7377-168-412	7378-168-411	7378-168-412	7379-168-411	7379-168-412
	SafariSeven Plain	FDE Brown	7376-168-551	7376-168-552	7377-168-551	7377-168-552	7378-168-551	7378-168-552	7379-168-551	7379-168-552
Sig Sauer P220, P226, P220R, P226R, P226R MK25 9mm, .40 4.41" P227 R3 .45 3.9" BBL	SafariSeven Plain	Black	7376-477-411	7376-477-412	7377-477-411	7377-477-412	7378-477-411	7378-477-412	7379-477-411	7379-477-412
	SafariSeven Plain	FDE Brown	7376-477-551	7376-477-552	7377-477-551	7377-477-552	7378-477-551	7378-477-552	7379-477-551	7379-477-552
Sig Sauer P220, P220R w/ ITI M3, TLR-1, TLR-1HL, Surefire X200, X300, X300U, 4.41" BBL	SafariSeven Plain	Black	7376-7702-411	7376-7702-412	7377-7702-411	7377-7702-412	7378-7702-411	7378-7702-412	7379-7702-411	7379-7702-412
	SafariSeven Plain	FDE Brown	7376-7702-551	7376-7702-552	7377-7702-551	7377-7702-552	7378-7702-551	7378-7702-552	7379-7702-551	7379-7702-552
	SafariSeven Basket	Black	7376-7702-481	7376-7702-482	7377-7702-481	7377-7702-482	7378-7702-481	7378-7702-482	7379-7702-481	7379-7702-482
Sig Sauer P226, P226R, P226R MK 9mm, .40 w/ ITI M3, TLR-1, TLR-1HL, Surefire X200, X300, X300U, 4.41" BBL	SafariSeven Hi-Gloss	Black	7376-7702-491	7376-7702-492	7377-7702-491	7377-7702-492	7378-7702-491	7378-7702-492	7379-7702-491	7379-7702-492
	SafariSeven Plain	Black	7376-4772-411	7376-4772-412	7377-4772-411	7377-4772-412	7378-4772-411	7378-4772-412	7379-4772-411	7379-4772-412
	SafariSeven Plain	FDE Brown	7376-4772-551	7376-4772-552	7377-4772-551	7377-4772-552	7378-4772-551	7378-4772-552	7379-4772-551	7379-4772-552
Sig Sauer P226R MK 9mm, .40 w/ ITI M3, TLR-1, TLR-1HL, Surefire X200, X300, X300U, 4.41" BBL	SafariSeven Basket	Black	7376-4772-481	7376-4772-482	7377-4772-481	7377-4772-482	7378-4772-481	7378-4772-482	7379-4772-481	7379-4772-482
	SafariSeven Hi-Gloss	Black	7376-4772-491	7376-4772-492	7377-4772-491	7377-4772-492	7378-4772-491	7378-4772-492	7379-4772-491	7379-4772-492
	SafariSeven Plain	Black	7376-6772-411	7376-6772-412	7377-6772-411	7377-6772-412	7378-6772-411	7378-6772-412	7379-6772-411	7379-6772-412
Sig Sauer P227, P227 R3 w/ ITI M3, TLR-1, TLR-1HL, Surefire X200, X300, X300U 3.9" BBL	SafariSeven Plain	FDE Brown	7376-6772-551	7376-6772-552	7377-6772-551	7377-6772-552	7378-6772-551	7378-6772-552	7379-6772-551	7379-6772-552
	SafariSeven Basket	Black	7376-6772-481	7376-6772-482	7377-6772-481	7377-6772-482	7378-6772-481	7378-6772-482	7379-6772-481	7379-6772-482
	SafariSeven Hi-Gloss	Black	7376-6772-491	7376-6772-492	7377-6772-491	7377-6772-492	7378-6772-491	7378-6772-492	7379-6772-491	7379-6772-492
Sig Sauer P229R DAK, P229R E2 9mm 3.9" BBL	SafariSeven Plain	Black	7376-474-411	7376-474-412	7377-474-411	7377-474-412	7378-474-411	7378-474-412	7379-474-411	7379-474-412
	SafariSeven Plain	FDE Brown	7376-474-551	7376-474-552	7377-474-551	7377-474-552	7378-474-551	7378-474-552	7379-474-551	7379-474-552
Sig Sauer P229, P229DAK, P229R 9mm w/ITI M3, TLR-1, TLR-1HL, Surefire X200, X300, X300U, 3.9" BBL	SafariSeven Plain	Black	7376-4742-411	7376-4742-412	7377-4742-411	7377-4742-412	7378-4742-411	7378-4742-412	7379-4742-411	7379-4742-412
	SafariSeven Plain	FDE Brown	7376-4742-551	7376-4742-552	7377-4742-551	7377-4742-552	7378-4742-551	7378-4742-552	7379-4742-551	7379-4742-552
	SafariSeven Basket	Black	7376-4742-481	7376-4742-482	7377-4742-481	7377-4742-482	7378-4742-481	7378-4742-482	7379-4742-481	7379-4742-482
Sig Sauer P229, P229R, .40 3.9" BBL	SafariSeven Hi-Gloss	Black	7376-4742-491	7376-4742-492	7377-4742-491	7377-4742-492	7378-4742-491	7378-4742-492	7379-4742-491	7379-4742-492
	SafariSeven Plain	Black	7376-447-411	7376-447-412	7377-447-411	7377-447-412	7378-447-411	7378-447-412	7379-447-411	7379-447-412
	SafariSeven Plain	FDE Brown	7376-447-551	7376-447-552	7377-447-551	7377-447-552	7378-447-551	7378-447-552	7379-447-551	7379-447-552
Sig Sauer P229, P229R .40 w/ ITI M3, TLR-1, TLR-1HL, Surefire X200, X300, X300U, 3.9" BBL	SafariSeven Plain	Black	7376-4472-411	7376-4472-412	7377-4472-411	7377-4472-412	7378-4472-411	7378-4472-412	7379-4472-411	7379-4472-412
	SafariSeven Plain	FDE Brown	7376-4472-551	7376-4472-552	7377-4472-551	7377-4472-552	7378-4472-551	7378-4472-552	7379-4472-551	7379-4472-552
	SafariSeven Basket	Black	7376-4472-481	7376-4472-482	7377-4472-481	7377-4472-482	7378-4472-481	7378-4472-482	7379-4472-481	7379-4472-482
Sig Sauer P320 Full Size 9mm, .40 4.7" BBL	SafariSeven Hi-Gloss	Black	7376-4472-491	7376-4472-492	7377-4472-491	7377-4472-492	7378-4472-491	7378-4472-492	7379-4472-491	7379-4472-492
	SafariSeven Plain	Black	7376-450-411	7376-450-412	7377-450-411	7377-450-412	7378-450-411	7378-450-412	7379-450-411	7379-450-412
	SafariSeven Plain	FDE Brown	7376-450-551	7376-450-552	7377-450-551	7377-450-552	7378-450-551	7378-450-552	7379-450-551	7379-450-552
Sig Sauer P320 Full Size 9mm, .40 w/ITI M3, TLR-1, TLR-1HL, Surefire X200/X300/ X300U, 4.7" BBL	SafariSeven Plain	Black	7376-4502-411	7376-4502-412	7377-4502-411	7377-4502-412	7378-4502-411	7378-4502-412	7379-4502-411	7379-4502-412
	SafariSeven Plain	FDE Brown	7376-4502-551	7376-4502-552	7377-4502-551	7377-4502-552	7378-4502-551	7378-4502-552	7379-4502-551	7379-4502-552
	SafariSeven Basket	Black	7376-4502-481	7376-4502-482	7377-4502-481	7377-4502-482	7378-4502-481	7378-4502-482	7379-4502-481	7379-4502-482
Sig Sauer P320 Full Size 9mm, .40 w/ITI M3, TLR-1, TLR-1HL, Surefire X200/X300/ X300U, 4.7" BBL	SafariSeven Hi-Gloss	Black	7376-4502-491	7376-4502-492	7377-4502-491	7377-4502-492	7378-4502-491	7378-4502-492	7379-4502-491	7379-4502-492

How to Order
Duty Holsters
Duty Accessories
Tactical Holsters
Tactical Accessories
Duty Bats
QAS
Speed Loaders
Light Systems
Concealment Holsters
Concealment Accessories
Competition
Apparel
Sales Support
Index/Price List

Concealment Holsters

7376/7377/7378/7379 7TS™ ALS® CONCEALMENT HOLSTERS FOR: PISTOLS (continued)

How to Order	Duty Holsters	GUN DESCRIPTION	FINISH	COLOR	7376		7377		7378		7379	
					RIGHT	LEFT	RIGHT	LEFT	RIGHT	LEFT	RIGHT	LEFT
Duty Accessories	Sig Sauer P320 Compact & Carry 9mm, .40 3.9" BBL	SafariSeven Plain	Black	7376-750-411	7376-750-412	7377-750-411	7377-750-412	7378-750-411	7378-750-412	7379-750-411	7379-750-412	
		SafariSeven Plain	FDE Brown	7376-750-551	7376-750-552	7377-750-551	7377-750-552	7378-750-551	7378-750-552	7379-750-551	7379-750-552	
Tactical Holsters	Sig Sauer P320 Compact & Carry 9mm, .40 w/ ITI M3, TLR-1, TLR-1HL, Surefire X200/ X300/X300U, 4.7" BBL	SafariSeven Plain	Black	7376-7502-411	7376-7502-412	7377-7502-411	7377-7502-412	7378-7502-411	7378-7502-412	7379-7502-411	7379-7502-412	
		SafariSeven Plain	FDE Brown	7376-7502-551	7376-7502-552	7377-7502-551	7377-7502-552	7378-7502-551	7378-7502-552	7379-7502-551	7379-7502-552	
		SafariSeven Basket	Black	7376-7502-481	7376-7502-482	7377-7502-481	7377-7502-482	7378-7502-481	7378-7502-482	7379-7502-481	7379-7502-482	
Tactical Accessories	Sig Sauer P320 Full Size .45 w/ ITI M3, TLR-1, TLR-1HL Surefire X200/X300/ X300U, 4.7" BBL	SafariSeven Hi-Gloss	Black	7376-7502-491	7376-7502-492	7377-7502-491	7377-7502-492	7378-7502-491	7378-7502-492	7379-7502-491	7379-7502-492	
		SafariSeven Plain	Black	7376-451-411	7376-451-412	7377-451-411	7377-451-412	7378-451-411	7378-451-412	7379-451-411	7379-451-412	
		SafariSeven Plain	FDE Brown	7376-451-551	7376-451-552	7377-451-551	7377-451-552	7378-451-551	7378-451-552	7379-451-551	7379-451-552	
Duty Belts	Sig Sauer P320 Full Size .45 w/ ITI M3, TLR-1, TLR-1HL Surefire X200/X300/ X300U, 3.9" BBL	SafariSeven Plain	Black	7376-4512-411	7376-4512-412	7377-4512-411	7377-4512-412	7378-4512-411	7378-4512-412	7379-4512-411	7379-4512-412	
		SafariSeven Plain	FDE Brown	7376-4512-551	7376-4512-552	7377-4512-551	7377-4512-552	7378-4512-551	7378-4512-552	7379-4512-551	7379-4512-552	
		SafariSeven Basket	Black	7376-4512-481	7376-4512-482	7377-4512-481	7377-4512-482	7378-4512-481	7378-4512-482	7379-4512-481	7379-4512-482	
Duty Holsters	Sig Sauer P320 Compact & Carry .45 w/ ITI M3, TLR-1, TLR-1HL Surefire X200/X300/X300U 3.9" BBL	SafariSeven Hi-Gloss	Black	7376-4512-491	7376-4512-492	7377-4512-491	7377-4512-492	7378-4512-491	7378-4512-492	7379-4512-491	7379-4512-492	
		SafariSeven Plain	Black	7376-751-411	7376-751-412	7377-751-411	7377-751-412	7378-751-411	7378-751-412	7379-751-411	7379-751-412	
		SafariSeven Plain	FDE Brown	7376-751-551	7376-751-552	7377-751-551	7377-751-552	7378-751-551	7378-751-552	7379-751-551	7379-751-552	
Speed Loaders	Sig Sauer P320 Compact & Carry .45 w/ ITI M3, TLR-1, TLR-1HL Surefire X200/X300/X300U 3.9" BBL	SafariSeven Plain	Black	7376-7512-411	7376-7512-412	7377-7512-411	7377-7512-412	7378-7512-411	7378-7512-412	7379-7512-411	7379-7512-412	
		SafariSeven Plain	FDE Brown	7376-7512-551	7376-7512-552	7377-7512-551	7377-7512-552	7378-7512-551	7378-7512-552	7379-7512-551	7379-7512-552	
		SafariSeven Basket	Black	7376-7512-481	7376-7512-482	7377-7512-481	7377-7512-482	7378-7512-481	7378-7512-482	7379-7512-481	7379-7512-482	
Light Systems	Smith & Wesson M&P .45 w/ITI M3, TLR-1, TLR-1HL, Surefire X200, X300, X300U 3.9" BBL	SafariSeven Plain	Black	7376-4192-411	7376-4192-412	7377-4192-411	7377-4192-412	7378-4192-411	7378-4192-412	7379-4192-411	7379-4192-412	
		SafariSeven Plain	FDE Brown	7376-4192-551	7376-4192-552	7377-4192-551	7377-4192-552	7378-4192-551	7378-4192-552	7379-4192-551	7379-4192-552	
		SafariSeven Basket	Black	7376-4192-481	7376-4192-482	7377-4192-481	7377-4192-482	7378-4192-481	7378-4192-482	7379-4192-481	7379-4192-482	
Concealment Holsters	Smith & Wesson M&P 9L, .40L 5" BBL	SafariSeven Plain	Black	7376-819-411	7376-819-412	7377-819-411	7377-819-412	7378-819-411	7378-819-412	7379-819-411	7379-819-412	
		SafariSeven Plain	FDE Brown	7376-819-551	7376-819-552	7377-819-551	7377-819-552	7378-819-551	7378-819-552	7379-819-551	7379-819-552	
		SafariSeven Basket	Black	7376-8192-411	7376-8192-412	7377-8192-411	7377-8192-412	7378-8192-411	7378-8192-412	7379-8192-411	7379-8192-412	
Concealment Accessories	Smith & Wesson M&P 9L, .40L w/ITI M3, TLR-1, TLR-1HL, Surefire X200, X300, X300U, 5" BBL	SafariSeven Plain	FDE Brown	7376-8192-551	7376-8192-552	7377-8192-551	7377-8192-552	7378-8192-551	7378-8192-552	7379-8192-551	7379-8192-552	
		SafariSeven Basket	Black	7376-8192-481	7376-8192-482	7377-8192-481	7377-8192-482	7378-8192-481	7378-8192-482	7379-8192-481	7379-8192-482	
		SafariSeven Hi-Gloss	Black	7376-8192-491	7376-8192-492	7377-8192-491	7377-8192-492	7378-8192-491	7378-8192-492	7379-8192-491	7379-8192-492	
Competition	Smith & Wesson M&P 9mm, .40 w/ XC-1 Surefire Light 4.25" BBL	SafariSeven Plain	Black	7376-2192-411	7376-2192-412	7377-2192-411	7377-2192-412	7378-2192-411	7378-2192-412	7379-2192-411	7379-2192-412	
		SafariSeven Plain	FDE Brown	7376-2192-551	7376-2192-552	7377-2192-551	7377-2192-552	7378-2192-551	7378-2192-552	7379-2192-551	7379-2192-552	
		SafariSeven Basket	Black	7376-2192-481	7376-2192-482	7377-2192-481	7377-2192-482	7378-2192-481	7378-2192-482	7379-2192-481	7379-2192-482	
Apparel	Smith & Wesson M&P 9/40 w/ ITI M3, TLR-1, TLR-1HL SureFire X200/X300/ X300U, 4.25" BBL	SafariSeven Hi-Gloss	Black	7376-2192-491	7376-2192-492	7377-2192-491	7377-2192-492	7378-2192-491	7378-2192-492	7379-2192-491	7379-2192-492	
		SafariSeven Plain	Black	7376-2192-411	7376-2192-412	7377-2192-411	7377-2192-412	7378-2192-411	7378-2192-412	7379-2192-411	7379-2192-412	
		SafariSeven Plain	FDE Brown	7376-2192-551	7376-2192-552	7377-2192-551	7377-2192-552	7378-2192-551	7378-2192-552	7379-2192-551	7379-2192-552	
Sales Support	Smith & Wesson M&P 9/40 SureFire XC-1 4.25" BBL	SafariSeven Plain	Black	7376-2192-411	7376-2192-412	7377-2192-411	7377-2192-412	7378-2192-411	7378-2192-412	7379-2192-411	7379-2192-412	
		SafariSeven Plain	FDE Brown	7376-2192-551	7376-2192-552	7377-2192-551	7377-2192-552	7378-2192-551	7378-2192-552	7379-2192-551	7379-2192-552	
		SafariSeven Basket	Black	7376-2192-481	7376-2192-482	7377-2192-481	7377-2192-482	7378-2192-481	7378-2192-482	7379-2192-481	7379-2192-482	
Index/ Price List	Smith & Wesson M&P 45C 4" BBL	SafariSeven Plain	Black	7376-919-411	7376-919-412	7377-919-411	7377-919-412	7378-919-411	7378-919-412	7379-919-411	7379-919-412	
		SafariSeven Plain	FDE Brown	7376-919-551	7376-919-552	7377-919-551	7377-919-552	7378-919-551	7378-919-552	7379-919-551	7379-919-552	
		SafariSeven Basket	Black	7376-919-481	7376-919-482	7377-919-481	7377-919-482	7378-919-481	7378-919-482	7379-919-481	7379-919-482	
Sales Support	Walther P99Q 4" BBL	SafariSeven Plain	Black	7376-384-411	7376-384-412	7377-384-411	7377-384-412	7378-384-411	7378-384-412	7379-384-411	7379-384-412	
		SafariSeven Plain	FDE Brown	7376-384-551	7376-384-552	7377-384-551	7377-384-552	7378-384-551	7378-384-552	7379-384-551	7379-384-552	
Sales Support	Walther P99Q 5" BBL	SafariSeven Plain	Black	7376-385-411	7376-385-412	7377-385-411	7377-385-412	7378-385-411	7378-385-412	7379-385-411	7379-385-412	
		SafariSeven Plain	FDE Brown	7376-385-551	7376-385-552	7377-385-551	7377-385-552	7378-385-551	7378-385-552	7379-385-551	7379-385-552	

Concealment Accessories

CD-AUTO CLIP-ON MAGAZINE HOLDER

FEATURES

- ▶ Black metal clip-on design
- ▶ Carries single magazine in a butt-up, Mid-ride position
- ▶ Ideal for plainclothes or off-duty use



DESCRIPTION	FINISH	COLOR	PART NO.
AMT Backup	Plain	Black	CD-84
Colt Government .380, Mustang	Plain	Black	CD-84
Walther PP, PPK/S	Plain	Black	CD-84
AMT Hardballer	Plain	Black	CD-45
Colt Combat Elite, Commander, Delta Elite, Delta Gold Cup, Gold Cup Nat'l Match, Government 1911, Officers' .45ACP	Plain	Black	CD-45
Kimber KIP45CUS	Plain	Black	CD-45
Ruger P-90	Plain	Black	CD-45
Sig Sauer P220	Plain	Black	CD-45
Springfield Armory 1911-A1	Plain	Black	CD-45
Beretta 84	Plain	Black	CD-81
Beretta 8000, 8040, 92 Brigadier, 92D, 92DS, 92F, 92FC, 92FCDA, 92FS, 92FS Centurion, 92G, 96, 96 Brigadier, 96D, 96DC, 96DS, 96G, 96 Centurion	Plain	Black	CD-76
Browning BDM 9mm	Plain	Black	CD-76
Heckler & Koch P7M13	Plain	Black	CD-76
Ruger KP-89, KP-89 DAO, KP-89 DAOW, KP-89 DC, KP-89 DW, KP-89 W, KP-91 DAO, KP-91 DC, KP-95 D, KP-95 DAO, KP-944, KP-944 DAO, KP-944 DAOW, KP-944 DC, KP-944 DW, KP-944 W, P-85, P-89, P-89 DC, P-89 DW, P-89 W, P-91 DAO, P-91 DC, P-93, P-94, P95 D, P95 DAO	Plain	Black	CD-76
Sig Sauer P226, P228, P229, SP2340	Plain	Black	CD-76
Smith & Wesson 59, 459, 469, 659, 669, 910, 915, 4006, 4013TSW, 4026, 4053TSW, 4056TSW 5903, 5904, 5906, 5923, 5924, 5926, 5946, 6904, 6906, 6924, 6926, 6946	Plain	Black	CD-76

How to Order
Duty Holsters
Duty Accessories
Tactical Holsters
Tactical Accessories
Duty Belts
QAS
Speed Loaders
Light Systems
Concealment Holsters
Concealment Accessories
Competition
Apparel
Sales Support
Index/Price List

Concealment Accessories

71 INJECTION MOLDED SINGLE MAGAZINE POUCH

FEATURES

- ▶ Flexible "accordion" design allows for multiple fits and minimal size
- ▶ Fits magazines, flashlights, knives and multi-tools
- ▶ Available in Black or Tan
- ▶ Fits from 1.5" (38mm) to 2.25" (58mm) belts



DESCRIPTION	COLOR	PART NO.
Injection Molded Single Magazine Pouch	Black	71-2-2
Injection Molded Single Magazine Pouch	FDE Brown	71-2-55
Injection Molded Single Magazine Pouch, Tactical	Black	71-2-23
Injection Molded Single Magazine Pouch, Tactical	FDE Brown	71-2-553
Injection Molded Single Magazine Pouch, IWB	Black	71-2-23-IWB
Injection Molded Single Magazine Pouch, IWB	FDE Brown	71-2-553-IWB
Injection Molded Single Magazine Pouch w/ ELS 34 Locking Fork	Black	71-2-23-MS34
Injection Molded Single Magazine Pouch w/ ELS 34 Locking Fork	FDE Brown	71-2-553-MS34
Injection Molded Single Magazine Pouch w/ Belt Clip	Black	71-2-23-744BL
Injection Molded Single Magazine Pouch w/ Belt Clip	FDE Brown	71-2-553-744BL

71MSA MOLLE SLIDING ADAPTER

FEATURES

- ▶ Compatible with Safariland Model 71 Tactical Universal Magazine Pouch
- ▶ Easily slides and locks into MOLLE webbing, removable in seconds
- ▶ Allows for use of Model 71 pouches on MOLLE vests with minimal footprint (only one column needed) and permits multiple pouches lined up side to side

COLOR	PART NO.
Black	71MSA-ADAPTER-2



How to Order
Duty Holsters
Duty Accessories
Tactical Holsters
Tactical Accessories
Duty Belts
QAS
Speed Loaders
Light Systems
Concealment Holsters
Concealment Accessories
Competition
Apparel
Sales Support
Index/Price List

Concealment Accessories

81 OPEN TOP LIGHTWEIGHT MAGAZINE POUCH



FEATURES

- ▶ Features a low-cut design
- ▶ Back side folds over to form snap-type belt loop
- ▶ For use on belts up to 1.75" (45mm)
- ▶ Available in Plain Black finish

DESCRIPTION	FINISH	COLOR	PART NO.
AMT Hardballer	Plain	Black	81-18-2
Beretta 8000, 8040, 92 Brigadier, 92D, 92DS, 92F, 92FC, 92FCM, 92FCDA, 92FS, 92FS Centurion, 92G, 96, 96 Brigadier, 96D, 96DC, 96DS, 96G, 96 Centurion	Plain	Black	81-18-2
Browning BDM 9mm, Hi-Power 9mm	Plain	Black	81-18-2
Colt Combat Elite, Commander, Delta Elite, Delta Elite, Delta Gold Cup, Double Eagle, Gold Cup Nat'l Match, Government 1911, Officers' .45ACP	Plain	Black	81-18-2
Heckler & Koch P7, P7M8, P7M13	Plain	Black	81-18-2
Kahr E9, K9 9mm, .40	Plain	Black	81-18-2
Kimber KIP45CUS	Plain	Black	81-18-2
Ruger KP-89, KP-89 DAO, KP-89 DAOW, KP-89 DC, KP-89 DW, KP-89 W, KP-90 DW, KP-90 W, KP-91 DAO, KP-91 DC, KP-95 D, KP-95 DAO, KP-944, KP-944 DAO, KP-944 DAOW, KP-944 DC, KP-944 DW, KP-944 W, P-85, P-89, P-89 DC, P-89 DW, P-89 W, P-91 DAO, P-91 DC, P-93, P-94, P-95 D, P-95 DAO	Plain	Black	81-18-2
Sig Sauer P220, P225, P226, P228, P239, P220R Compact, P226R MK25	Plain	Black	81-18-2
Smith & Wesson 39, 59, 439, 459, 457, 469, 639, 645, 659, 669, 909, 910, 915, 1006, 1026, 1046, 1066, 1076, 1086, 3904, 3906, 3913, 3913TSW, 3913LS, 3913NL, 3914, 3914LS, 3953, 3953TSW, 3954, 4006, 4013, 4013TSW, 4026, 4053, 4053TSW, 4056TSW, 4506, 4506-1, 4513TSW, 4516-1, 4516-2, 4526, 4536, 4546, 4553TSW, 4556, 4566, 4576, 4586, 5903, 5904, 5906, 5923, 5924, 5926, 5946, 6904, 6906, 6924, 6926, 6946, CS9	Plain	Black	81-18-2

All guns listed in this section utilize the above listed part numbers. The next section starts on the next page.

Concealment Accessories

81 OPEN TOP LIGHTWEIGHT MAGAZINE POUCH (continued)

DESCRIPTION	FINISH	COLOR	PART NO.
Springfield Armory 1911-A1, XD 9mm, .40	Plain	Black	81-18-2
Taurus PT-92, PT-92C, PT-99, PT-99C, PT-101	Plain	Black	81-81-2
Beretta 8045F	Plain	Black	81-83-2
Glock 17, 19, 22, 23, 26, 27, 34, 35	Plain	Black	81-83-2
Heckler & Koch USP 9C, 40C, P2000 12-Round	Plain	Black	81-83-2
Ruger SR9	Plain	Black	81-83-2
Sig Sauer P229, SP2340, P250 DC	Plain	Black	81-83-2
Smith & Wesson Sigma 9C, Sigma 40C, Sigma 9F, Sigma 40F, SW9V, SW40V, M&P 9C, M&P SHIELD 9mm	Plain	Black	81-83-2
Springfield Armory XD(M) .40	Plain	Black	81-83-2
Walther P99C QA	Plain	Black	81-83-2
Heckler & Koch .40, USP 45C	Plain	Black	81-383-2
Glock 20, 21, 29, 30	Plain	Black	81-383-2
Para-Ordnance P14	Plain	Black	81-383-2
Smith & Wesson M&P .45	Plain	Black	81-383-2
Colt Government 380, Mustang	Plain	Black	81-89-2
Smith & Wesson Sigma 380	Plain	Black	81-89-2
Walther PP, PPK, PPK/S	Plain	Black	81-89-2

How to Order
Duty Holsters
Duty Accessories
Tactical Holsters
Tactical Accessories
Duty Belts
QAS
Speed Loaders
Light Systems
Concealment Holsters
Concealment Accessories
Competition
Apparel
Sales Support
Index/Price List

Concealment Accessories

123 HORIZONTAL MAGAZINE POUCH



FEATURES

- ▶ Single magazine holder – carries magazines in a horizontal position
- ▶ Hook and loop belt attachment wraps around belt
- ▶ Available in Plain Black finish

DESCRIPTION	FINISH	COLOR	PART NO.
AMT Hardballer	Plain	Black	123-18-2
Beretta 8000, 8040, 92 Brigadier, 92D, 92DS, 92F, 92FC, 92FCM, 92FCDA, 92FS, 92FS Centurion, 92G, 96, 96 Brigadier, 96D, 96DC, 96DS, 96G, 96 Centurion	Plain	Black	123-18-2
Browning BDM 9mm	Plain	Black	123-18-2
Colt Combat Elite, Commander, Delta Elite, Delta Gold Cup, Double Eagle, Gold Cup Nat'l Match, Government 1911, Officers' .45ACP	Plain	Black	123-18-2
Heckler & Koch P7, P7M8, P7M13	Plain	Black	123-18-2
Kimber KIP45CUS	Plain	Black	123-18-2
Leatherman PST II, Pocket Survival Tool, Gerber Multi-Plier Pocket Tool, 3.5" to 4" Folding Knives	Plain	Black	123-18-2
Ruger KP-89, KP-89 DAO, KP-89 DAOW, KP-89 DC, KP-89 DW, KP-89 W, KP-91 DAO, KP-91 DC, KP-95 D, KP-95 DAO, KP-944, KP-944 DAO, KP-944 DAOW, KP-944 DC, KP-944 DW, KP-944 W, P-85, P-89, P-89 DC, P-89 DW, P-89 W, P-91 DAO, P-91 DC, P-93, P-94, P-95 D, P-95 DAO	Plain	Black	123-18-2
Sig Sauer P220, P225, P226, P228, P229, P239, SP2340, P220R Compact, P226R MK25	Plain	Black	123-18-2
Smith & Wesson 39, 59, 439, 459, 469, 639, 645, 659, 669, 909, 910, 915, 1006, 1026, 1046, 1066, 1076, 1086, 3904, 3906, 3913, 3913LS, 3913NL, 3913TSW, 3914, 3914LS, 3953, 3954, 3953TSW, 4006, 4013, 4013TSW, 4014, 4026, 4053, 4053TSW, 4054, 4056TSW, 4506, 4506-1, 4513TSW, 4516-1, 4516-2, 4526, 4536, 4546, 4553TSW, 4556, 4566, 457, 4576, 4586, 5903, 5904, 5906, 5923, 5924, 5926, 5946, 6904, 6906, 6924, 6926, 6946, CS9, M&P SHIELD 9mm	Plain	Black	123-18-2

	Length	Height	Width
123-1	4 1/2" (114mm)	3/4" (19mm)	1 1/2" (38mm)
123-383	6 1/4" (158mm)	1 1/8" (28mm)	2 1/8" (54mm)
123-83	6" (152mm)	1" (25.5mm)	2" (50mm)
123-18	6" (152mm)	1" (25.5mm)	1 3/4" (45mm)

Concealment Accessories

123 HORIZONTAL MAGAZINE POUCH (continued)

DESCRIPTION	FINISH	COLOR	PART NO.
Springfield Armory 1911-A1, XD 9mm, .40	Plain	Black	123-18-2
Taurus PT-92, PT-92C, PT-99, PT-99C, PT-101	Plain	Black	123-18-2
Beretta 8045F	Plain	Black	123-83-2
Glock 17, 19, 22, 23, 34, 35	Plain	Black	123-83-2
Heckler & Koch USP 9C, 40C, P2000 12-Round	Plain	Black	123-83-2
Ruger SR9	Plain	Black	123-83-2
Smith & Wesson Sigma 9F, Sigma 40F, M&P 9C	Plain	Black	123-83-2
Walther P99C QA	Plain	Black	123-83-2
Glock 20, 21, 29, 30	Plain	Black	123-383-2
Heckler & Koch .40, USP 45C	Plain	Black	123-383-2
Para-Ordnance P14	Plain	Black	123-383-2
Smith & Wesson M&P .45	Plain	Black	123-383-2
Leatherman Mini Tool, Original Tool, Pocket Survival Tool	Plain	Black	123-1-2

How to Order
Duty Holsters
Duty Accessories
Tactical Holsters
Tactical Accessories
Duty Belts
QAS
Speed Loaders
Light Systems
Concealment Holsters
Concealment Accessories
Competition
Apparel
Sales Support
Index/Price List

Concealment Accessories

074 OPEN TOP SINGLE MAGAZINE POUCH, PADDLE



FEATURES

- ▶ Paddle-style single magazine holder
- ▶ Features built-in locking mechanism that keeps the holder in place at all times
- ▶ Fits belts up to 1.5" (38mm) wide
- ▶ Adjustable tension device
- ▶ Available in Plain Black or STX finishes

* Right Hand Pouch Shown

DESCRIPTION	FINISH	COLOR	RIGHT	LEFT
AMT	Plain	Black	074-53-61	074-53-62
Hardballer	STX Tactical	Black	074-53-131	074-53-132
STX Basket	Black	074-53-481	074-53-482	
Colt				
Combat Elite, Commander, Delta Elite, Delta Gold Cup, Gold Cup Nat'l Match, Government 1911, Officers' .45ACP				
Kimber				
KIP45CUS				
Sig Sauer				
P220, P220R Compact				
Springfield Armory				
1911-A1				
Beretta	Plain	Black	074-76-61	074-76-62
8000, 8040, 92 Brigadier, 92D, 92DS, 92F, 92FC, 92FCDA, 92FS, 92FS Centurion, 92G, 96, 96 Brigadier, 96D, 96DC, 96DS, 96G, 96 Centurion	STX Tactical STX Basket	Black Black	074-76-131 074-76-481	074-76-132 074-76-482
Browning				
BDM 9mm				
EAA				
Witness 9mm, Witness 40SW				
Heckler & Koch				
P7M13				
Ruger				
KP-89, KP-89 DAO, KP-89 DAOW, KP-89 DC, KP-89 DW, KP-89 W, KP-91 DAO, KP-91 DC, KP-95 D, KP-95 DAO, KP-944, KP-944 DAO, KP-944 DAOW, KP-944 DC, KP-944 DW, KP-944 W, P-85, P-89, P-89 DC, P-89 DW, P-89 W, P-91 DAO, P-91 DC, P-93, P-94, P-95 D, P-95 DAO				
Sig Sauer				
P226, P228, P226R MK25				
Smith & Wesson				
59, 459, 469, 659, 669, 910, 915, 4006, 4013TSW, 4026, 4053TSW, 4056TSW, 5903, 5904, 5906, 5923, 5924, 5926, 5946, 6904, 6906, 6924, 6926, 6946				
Springfield Armory				
P-9				
Taurus				
PT-92, PT-92C, PT-99, PT-99C, PT-100				
Walther				
P99				

Note: Order Mag Pouch by which hand you shoot with. Right for right, left for left. Right handed shooters wear pouch on the left side. Opening of pouch and bullets in magazine face forward for both right and left handed shooters (Opposite for left handed shooter- reload with left hand.)

All guns listed in this section utilize the above listed part numbers. The next section starts with the Berettas on the next page.

Concealment Accessories

074 OPEN TOP SINGLE MAGAZINE POUCH, PADDLE (continued)

DESCRIPTION	FINISH	COLOR	RIGHT	LEFT
Beretta 92FCM STX Basket	Plain STX Tactical Black	Black Black 074-118-481	074-118-61 074-118-131 074-118-482	074-118-62 074-118-132
Heckler & Koch P7, P7M8				
Kahr E9, K9 9mm, .40				
Sig Sauer P225, P239				
Smith & Wesson 39, 439, 639, 909, 3904, 3906, 3913, 3913LS, 3913NL, 3913TSW, 3914, 3914LS, 3953, 3953TSW, 3954, CS9				
Caspian STX Tactical EAA	Plain Black STX Basket	Black 074-950-131 Black	074-950-61 074-950-132 074-950-481	074-950-62 074-950-482
FN FNS 9mm, .40				
Glock 17, 19, 22, 23, 26, 27, 34, 35 STX Basket	Plain STX Tactical Black	Black Black 074-83-481	074-83-61 074-83-131 074-83-482	074-83-62 074-83-132
Heckler & Koch P30				
Heckler & Koch USP 9C, 40C, 2000 12-Round				
Ruger SR9				
Sig Sauer P229, SP2340				
Smith & Wesson Sigma 9C, Sigma 40C, Sigma 9mm, Sigma 40F, SW9V, SW40V, M&P 9C				
Glock 20, 21, 29, 30 STX Basket	Plain STX Tactical Black	Black Black 074-383-481	074-383-61 074-383-131 074-383-482	074-383-62 074-383-132
Heckler & Koch USP 45C, USP .45				
Springfield XD, XD(M) 9mm, .40				
Springfield Armory XD .45, XD(M) .45				
Smith & Wesson M&P .45				
Beretta 8045F STX Basket	Plain STX Tactical Black	Black Black 074-850-481	074-850-61 074-850-131 074-850-482	074-850-62 074-850-132
Heckler & Koch USP 9mm, .40				
Para-Ordnance P14				
Strayer-Voigt Infinity				
Ruger P-90 STX Basket	Plain STX Tactical Black	Black Black 074-23-481	074-23-61 074-23-131 074-23-482	074-23-62 074-23-132
Smith & Wesson 457, 645, 1006, 1026, 1046, 1066, 1076, 1086, 4013, 4053, 4506, 4506-1, 4513TSW, 4516-1, 4516-2, 4526, 4536, 4546, 4553TSW, 4556, 4566, 4576, 4586				
Colt Government 380, Mustang STX Basket	Plain STX Tactical Black	Black Black 074-89-481	074-89-61 074-89-131 074-89-482	074-89-62 074-89-132
Smith & Wesson Sigma 380				
Walther PP, PPK, PPK/S				

How to Order
Duty Holsters
Duty Accessories
Tactical Holsters
Tactical Accessories
Duty Bats
QAS
Speed Loaders
Light Systems
Concealment Holsters
Concealment Accessories
Competition
Apparel
Sales Support
Index/Price List

Concealment Accessories

079 OPEN TOP DOUBLE MAGAZINE POUCH, SNAP-ON



FEATURES

- ▶ Low-cut design for easy magazine grasp
- ▶ For use on belts up to 1.75" (45mm) wide
- ▶ Adjustable tension device
- ▶ Molded using SafariLaminate™ wraparound construction
- ▶ Available in Plain Black, Basketweave, or STX finishes

DESCRIPTION	FINISH	COLOR	PART NO.
AMT	Plain	Black	079-53-6
Hardballer	Basket	Black	079-53-8
	STX Tactical	Black	079-53-13
Beretta	STX Plain	Black	079-53-41
92FCM	STX Basket	Black	079-53-48
	STX Hi Gloss	Black	079-53-49
Colt	STX Foliage Green	Foliage Green	079-53-54
Combat Elite,	STX Coyote Brown	Coyote Brown	079-53-76
Commander,	STX OD Green	OD Green	079-53-56
Delta Elite , Delta Gold Cup,	STX FDE Brown	FDE Brown	079-53-55
Gold Cup Nat'l Match,			
Government 1911, Officers' .45ACP			
Kimber			
KIP45CUS			
Ruger			
P-90			
Sig Sauer			
P220, P220R Compact			
Smith & Wesson			
645, 1006, 1026, 1046,			
1066, 1076, 1086, 4013, 4053, 4506, 4506-1, 4513TSW, 4516-1, 4516-2, 4526, 4536, 4546, 4553TSW,			
4556, 4566, 457, 4576, 4586			
Springfield Armory			
1911-A1			
Beretta	Plain	Black	079-18-6
8000, 8040, 92 Brigadier,	Basket	Black	079-18-8
92D, 92DS, 92F,	STX Tactical	Black	079-18-13
92FC, 92FCDA, 92FS,	STX Plain	Black	079-18-41
92FS Centurion, 92G, 96,	STX Basket	Black	079-18-48
96 Brigadier, 96D, 96DC,	STX Hi Gloss	Black	079-18-49
96DS, 96G, 96 Centurion	STX Foliage Green	Foliage Green	079-18-54
	STX Coyote Brown	Coyote Brown	079-18-76
Browning	STX OD Green	OD Green	079-18-56
BDM 9mm	STX FDE Brown	FDE Brown	079-18-55
Heckler & Koch			
P7M13			
Ruger			
P-85, KP-89, KP-89 DAO, KP-89 DAOW, KP-89 DC, KP-89 DW, KP-89 W, P-89, P-89 DC,			
P-89 DW, P-89 W, P-93, P-94, 9mm KP-91 DC, KP-91 DAO, P-91 DC, P-91 DAO, 40 S&W, 4.5" BBL			
Ruger			
KP-944, KP-944 DAO, KP-944 DAOW,			
KP-944 DC, KP-944 DW, KP-944 W			
4.2" BBL			
Ruger			
KP-95 D, KP-95 DAO, P-95 D, P-95 D.A.O			
4.2" BBL			
Sig Sauer			
P226, P228, P226R MK25			
Smith & Wesson			
59, 459, 469, 659, 669, 910, 915, 4006,			
4013TSW, 4026, 4053TSW, 4056TSW,			
5903, 5904, 5906, 5923, 5924, 5926,			
5946, 6904, 6906, 6924, 6926, 6946			
Springfield Armory			
XD 9mm, .40			
Taurus			
PT-92, PT-92C, PT-99, PT-99C, PT-101			
Walther			
P99C QA			

Available in 2.25" belt loop. Sample Code: 079-18-6-2

Concealment Accessories

079 OPEN TOP DOUBLE MAGAZINE POUCH, SNAP-ON (continued)

DESCRIPTION	FINISH	COLOR	PART NO.
Heckler & Koch P7, P7M8	Plain	Black	079-118-6
	Basket	Black	079-118-8
	STX Tactical	Black	079-118-13
Kahr E9, K9 9mm, .40	STX Plain	Black	079-118-41
	STX Basket	Black	079-118-48
Sig Sauer P225, P239	STX Hi Gloss	Black	079-118-49
	STX Foliage Green	Foliage Green	079-118-54
	STX Coyote Brown	Coyote Brown	079-118-76
Smith & Wesson 39, 439, 639, 909, 3904, 3906, 3913, 3913LS, 3913NL, 3913TSW, 3914, 3914LS, 3953, 3953TSW, 3954 CS9	STX OD Green	OD Green	079-118-56
	STX FDE Brown	FDE Brown	079-118-55
Beretta 8045F	Plain	Black	079-83-6
	Basket	Black	079-83-8
	STX Tactical	Black	079-83-13
Caspian	STX Plain	Black	079-83-41
	STX Basket	Black	079-83-48
EAA 38 Super	STX Hi Gloss	Black	079-83-49
	STX Foliage Green	Foliage Green	079-83-54
	STX Coyote Brown	Coyote Brown	079-83-76
Glock 17, 19, 22, 23, 26, 27, 34, 35	STX OD Green	OD Green	079-83-56
	STX FDE Brown	FDE Brown	079-83-55
Heckler & Koch USP 9C, 40C, P2000 12-Round			
Ruger SR9			
Sig Sauer P229, SP2340			
Smith & Wesson Sigma 9C, Sigma 40C, Sigma 40F, Sigma 9mm, SW9V, SW40V, M&P 9C			
Springfield Armory XD(M) .40			
Glock 20, 21	Plain	Black	079-383-6
	Basket	Black	079-383-8
	STX Tactical	Black	079-383-13
Heckler & Koch .40, USP 45C	STX Plain	Black	079-383-41
	STX Basket	Black	079-383-48
McCormick/Tripp	STX Hi Gloss	Black	079-383-49
	STX Foliage Green	Foliage Green	079-383-54
	STX Coyote Brown	Coyote Brown	079-383-76
Para-Ordnance P14	STX OD Green	OD Green	079-383-56
	STX FDE Brown	FDE Brown	079-383-55
Springfield Armory XD .45			
Strayer-Voigt Infinity			
Colt Government 380, Mustang	Plain	Black	079-89-6
	Basket	Black	079-89-8
	STX Tactical	Black	079-89-13
Smith & Wesson Sigma 380	STX Plain	Black	079-89-41
	STX Basket	Black	079-89-48
	STX Hi Gloss	Black	079-89-49
Walther PP, PPK, PPK/S	STX Foliage Green	Foliage Green	079-89-54
	STX Coyote Brown	Coyote Brown	079-89-76
	STX OD Green	OD Green	079-89-56
Smith & Wesson M&P .45	STX FDE Brown	FDE Brown	079-89-55
	Plain	Black	079-419-6*
	Basket	Black	079-419-8*
Smith & Wesson M&P .45	STX Tactical	Black	079-419-13*
	STX Plain	Black	079-419-41*
	STX Basket	Black	079-419-48*
	STX Hi Gloss	Black	079-419-49*
	STX Foliage Green	Foliage Green	079-419-54*
	STX Coyote Brown	Coyote Brown	079-419-76*
	STX OD Green	OD Green	079-419-56*
	STX FDE Brown	FDE Brown	079-419-55*

* Not available in 2.25" (58mm) belt loop

How to
Order
Duty
Holsters
Duty
Accessories
Tactical
Holsters
Tactical
Accessories
Duty
Belts
QAS
Speed
Loaders
Light
Systems
Concealment
Holsters
Concealment
Accessories
Competition
Apparel
Sales
Support
Index/
Price
List

Concealment Accessories

572 OPEN TOP DOUBLE MAGAZINE POUCH, PADDLE



FEATURES

- ▶ Low-cut design allows for quick access
- ▶ Unique paddle design features a self-locking belt hook
- ▶ Adjustable tension device
- ▶ Available in Plain Black, Basketweave, or STX finishes

DESCRIPTION	FINISH	COLOR	PART NO.
AMT	Plain	Black	572-53-2
Hardballer	STX Plain	Black	572-53-41
	STX Basket	Black	572-53-48
Beretta	STX Tactical	Black	572-53-13
92FCM	STX Hi Gloss	Black	572-53-49
	STX Foliage Green	Foliage Green	572-53-54
Colt	STX Coyote Brown	Coyote Brown	572-53-76
Combat Elite,	STX OD Green	OD Green	572-53-56
Commander,	STX FDE Brown	FDE Brown	572-53-55
Delta Elite,			
Delta Gold Cup,			
Gold Cup Nat'l Match,			
Government 1911,			
Officers' .45ACP			
Kahr			
E9, K9 9mm, .40			
Kimber			
KIP45CUS			
Ruger			
P-90			
Sig Sauer			
P220, P225, P239, P220R Compact			
Smith & Wesson			
39, 439, 639, 645, 1006, 1026, 1046, 1066,			
1076, 1086, 3904, 3906, 3913, 3913TSW,			
3914, 3953, 3953TSW, 3954, 4013, 4053, 4506,			
4506-1, 4513TSW, 4516-1, 4516-2, 4526, 4536,			
4546, 4553TSW, 4556, 4566, 457, 4576, 4586, CS9			
Springfield Armory			
1911-A1			
Beretta	Plain	Black	572-76-2
8000, 8040, 92 Brigadier,	STX Plain	Black	572-76-41
92D, 92DS, 92F,	STX Basket	Black	572-76-48
92FC, 92FCDA,	STX Tactical	Black	572-76-13
92FS, 92FS Centurion,	STX Hi Gloss	Black	572-76-49
92G, 96, 96 Brigadier,	STX Foliage Green	Foliage Green	572-76-54
96D, 96DC, 96DS,	STX Coyote Brown	Coyote Brown	572-76-76
96G, 96 Centurion	STX OD Green	OD Green	572-76-56
	STX FDE Brown	FDE Brown	572-76-55
Browning			
BDM 9mm			
Heckler & Koch			
P7 M13			
Ruger			
KP-89, KP-89 DAO, KP-89 DAOW,			
KP-89 DC, KP-89 DW, KP-89 W, KP-91 DC,			
KP-91 DAO, KP-95 D, KP-95 DAO, KP-944,			
KP-944 DAO, KP-944 DAOW, KP-944 DC,			
KP-944 DW, KP-944 W, P-85, P-89, P-89 DC,			
P-89 DW, P-89 W, P-91 DC, P-91 DAO, P-93,			
P-94, P-95 D, P-95 D.A.O			

Concealment Accessories

572 OPEN TOP DOUBLE MAGAZINE POUCH, PADDLE (continued)

DESCRIPTION	FINISH	COLOR	PART NO.
Sig Sauer P226, P228, P226R MK25	Plain	Black	572-76-2
	STX Plain	Black	572-76-41
	STX Basket	Black	572-76-48
Smith & Wesson 59, 459, 469, 659, 669, 910, 915, 4006, 4013TSW, 4026, 4053TSW, 4056TSW, 5903, 5904, 5906, 5923, 5924, 5926, 5946, 6904, 6906, 6924, 6926, 6946	STX Tactical	Black	572-76-13
	STX Hi Gloss	Black	572-76-49
	STX Foliage Green	Foliage Green	572-76-54
	STX Coyote Brown	Coyote Brown	572-76-76
	STX OD Green	OD Green	572-76-56
	STX FDE Brown	FDE Brown	572-76-55
Springfield Armory XD 9mm, .40			
Taurus PT-92, PT-92C, PT-99, PT-99C, PT-101			
Walther P99C QA			
Glock 17, 19, 22, 23, 26, 27, 34, 35	Plain	Black	572-83-2
	STX Plain	Black	572-83-41
	STX Basket	Black	572-83-48
Heckler & Koch P2000 12-Round	STX Tactical	Black	572-83-13
	STX Hi Gloss	Black	572-83-49
	STX Foliage Green	Foliage Green	572-83-54
Ruger SR9	STX Coyote Brown	Coyote Brown	572-83-76
	STX OD Green	OD Green	572-83-56
	STX FDE Brown	FDE Brown	572-83-55
Sig Sauer P229, SP2340			
Smith & Wesson Sigma 9C, Sigma 40C, Sigma 9F, Sigma 40F, SW9V, SW40V, M&P 9C			
Springfield Armory XD(M) .40			
Glock 20, 21	Plain	Black	572-383-2
	STX Plain	Black	572-383-41
	STX Basket	Black	572-383-48
Heckler & Koch USP 9mm, .40, .45, USP 40C	STX Tactical	Black	572-383-13
	STX Hi Gloss	Black	572-383-49
	STX Foliage Green	Foliage Green	572-383-54
Para-Ordnance P14	STX Coyote Brown	Coyote Brown	572-383-76
	STX OD Green	OD Green	572-383-56
	STX FDE Brown	FDE Brown	572-383-55
Smith & Wesson M&P .45	Plain	Black	572-419-2
	STX Plain	Black	572-419-41
	STX Basket	Black	572-419-48
	STX Tactical	Black	572-419-13
	STX Hi Gloss	Black	572-419-49
	STX Foliage Green	Foliage Green	572-419-54
	STX Coyote Brown	Coyote Brown	572-419-76
	STX OD Green	OD Green	572-419-56
STX FDE Brown	FDE Brown	572-419-55	

How to Order
Duty Holsters
Duty Accessories
Tactical Holsters
Tactical Accessories
Duty Bats
QAS
Speed Loaders
Light Systems
Concealment Holsters
Concealment Accessories
Competition
Apparel
Sales Support
Index/Price List

Concealment Accessories

573 OPEN TOP MAGAZINE & HANDCUFF POUCH



FEATURES

- ▶ Unique paddle design features a self-locking belt hook
- ▶ Adjustable tension device
- ▶ Standard chain style cuffs only
- ▶ Right hand is worn on left side of body with magazine toward front
- ▶ Fits belts up to 1.75" (45mm) width
- ▶ Available in Plain Black or STX finishes

DESCRIPTION	FINISH	COLOR	RIGHT	LEFT
AMT	Plain	Black	573-53-21	573-53-22
Hardballer	STX Plain	Black	573-53-411	573-53-412
	STX Basket	Black	573-53-481	573-53-482
	STX Tactical	Black	573-53-131	573-53-132
Beretta 92FCM	STX Hi Gloss	Black	573-53-491	573-53-492
	STX Foliage Green	Foliage Green	573-53-541	573-53-542
Colt	STX Coyote Brown	Coyote Brown	573-53-761	573-53-762
	STX OD Green	OD Green	573-53-561	573-53-562
	STX FDE Brown	FDE Brown	573-53-761	573-53-552
Combat Elite, Commander, Delta Elite, Delta Gold Cup, Gold Cup Nat'l Match, Government 1911, Officers' .45ACP				
Kahr E9, K9 9mm, .40				
Kimber KIP45CUS				
Ruger P-90				
Sig Sauer P220, P225, P239, P220R Compact				
Smith & Wesson 39, 439, 457, 639, 645, 1006, 1026, 1046, 1066, 1076, 1086, 3904, 3906, 3913, 3913TSW, 3914, 3953, 3953TSW, 3954, 4013, 4053, 4506, 4506-1, 4513TSW, 4516-1, 4516-2, 4526, 4536, 4546, 4553TSW, 4556, 4566, 4576, 4586, CS9				
Springfield Armory 1911-A1				
Beretta 8000, 8040, 92 Brigadier, 92D, 92DS, 92F, 92FC, 92FCDA, 92FS, 92FS Centurion, 92G, 96, 96 Brigadier, 96D, 96DC, 96DS, 96G, 96 Centurion	Plain	Black	573-76-21	573-76-22
	STX Plain	Black	573-76-411	573-76-412
	STX Basket	Black	573-76-481	573-76-482
	STX Tactical	Black	573-76-131	573-76-132
	STX Hi Gloss	Black	573-76-491	573-76-492
	STX Foliage Green	Foliage Green	573-76-541	573-76-542
	STX Coyote Brown	Coyote Brown	573-76-761	573-76-762
Browning BDM 9mm	STX OD Green	OD Green	573-76-561	573-76-562
	STX FDE Brown	FDE Brown	573-76-761	573-76-552
Heckler & Koch P7 M13				
Ruger KP-89, KP-89 DAO, KP-89 DAOW, KP-89 DC, KP-89 DW, KP-89 W, KP-91 DAO, KP-91 DC, KP-95 D, KP-95 DAO, KP-944, KP-944 DAO, KP-944 DC, KP-944 DW, KP-944 W, P-85, P-89, P-89 DC, P-89 DW, P-89 W, P-91 DAO, P-91 DC, P-93, P-94, P-95 D, P-95 DAO				

Concealment Accessories

573 OPEN TOP MAGAZINE & HANDCUFF POUCH (continued)

DESCRIPTION	FINISH	COLOR	RIGHT	LEFT
Sig Sauer P226, P228, P226R MK25	Plain STX Plain STX Basket	Black Black Black	573-76-21 573-76-411 573-76-481	573-76-22 573-76-412 573-76-482
Smith & Wesson 59, 459, 469, 659, 669, 910, 915, 4006, 4013TSW, 4026, 4053TSW, 4056TSW, 5903, 5904, 5906, 5923, 5924, 5926, 5946, 6904, 6906, 6924, 6926, 6946	STX Tactical STX Hi Gloss STX Foliage Green STX Coyote Brown STX OD Green STX FDE Brown	Black Black Foliage Green Coyote Brown OD Green FDE Brown	573-76-131 573-76-491 573-76-541 573-76-761 573-76-561 573-76-761	573-76-132 573-76-492 573-76-542 573-76-762 573-76-562 573-76-762
Springfield Armory XD 9mm, .40				
Taurus PT-92, PT-92C, PT-99, PT-99C, PT-101				
Walther P99C QA				
Beretta 8045F	Plain STX Plain STX Basket	Black Black Black	573-83-21 573-83-411 573-83-481	573-83-22 573-83-412 573-83-482
Glock 17, 19, 22, 23, 26, 27, 34, 35	STX Tactical STX Hi Gloss STX Foliage Green	Black Black Foliage Green	573-83-131 573-83-491 573-83-541	573-83-132 573-83-492 573-83-542
Heckler & Koch USP 9mm, .40, USP 9C, 40C P2000 12-Round	STX Coyote Brown STX OD Green STX FDE Brown	Coyote Brown OD Green FDE Brown	573-83-761 573-83-561 573-83-761	573-83-762 573-83-562 573-83-762
Ruger SR9				
Sig Sauer P229, SP2340				
Smith & Wesson Sigma 9C, Sigma 40C, Sigma 9F, Sigma 40F, SW9V, SW40V, M&P 9C				
Springfield Armory XD(M) .40				
Glock 20, 21	Plain STX Plain STX Basket	Black Black Black	573-383-21 573-383-411 573-383-481	573-383-22 573-383-412 573-383-482
Heckler & Koch USP .45, HK .45	STX Tactical STX Hi Gloss STX Foliage Green	Black Black Foliage Green	573-383-131 573-383-491 573-383-541	573-383-132 573-383-492 573-383-542
Para-Ordnance P14	STX Coyote Brown STX OD Green STX FDE Brown	Coyote Brown OD Green FDE Brown	573-383-761 573-383-561 573-383-761	573-383-762 573-383-562 573-383-762
Smith & Wesson M&P .45	Plain STX Plain STX Basket STX Tactical STX Hi Gloss STX Foliage Green STX Coyote Brown STX OD Green STX FDE Brown	Black Black Black Black Black Foliage Green Coyote Brown OD Green FDE Brown	573-419-2 573-419-411 573-419-481 573-419-131 573-419-491 573-419-541 573-419-761 573-419-561 573-419-761	573-419-22 573-419-412 573-419-482 573-419-132 573-419-492 573-419-542 573-419-762 573-419-562 573-419-762

How to Order
Duty Holsters
Duty Accessories
Tactical Holsters
Tactical Accessories
Duty Bats
QAS
Speed Loaders
Light Systems
Concealment Holsters
Concealment Accessories
Competition
Apparel
Sales Support
Index/Price List

Concealment Accessories

574 MAGAZINE HOLDER AND LIGHT POUCH, PADDLE



FEATURES

- ▶ Low-cut design allows for quick access
- ▶ Adjustable tension device
- ▶ Unique paddle design features a self-locking hook
- ▶ For use on belts up to 1.75" (45mm)
- ▶ Fits up to 1.3" diameter lights

DESCRIPTION	FINISH	COLOR	RIGHT	LEFT
AMT Hardballer	STX Tactical	Black	574-53-131	574-53-132
	STX Tactical	Foliage Green	574-53-541	574-53-542
	STX Tactical	Coyote Brown	574-53-761	574-53-762
Colt Comabt Elite, Commander, Delta Elite, Delta Gold Cup, Gold Cup Nat'l Match, Government 1911, Officers' ACP	STX Tactical	OD Green	574-53-561	574-53-562
	STX Tactical	FDE Brown	574-53-551	574-53-552
Kimber KIP45CUS				
Sig Sauer P220, P220 Compact				
Springfield Armory 1911-A1				
Beretta 8000, 8040, 92 Brigadier, 92D, 92DS, 92F, 92FC, 92FCDA, 92FS, 92FS Centurion, 92G, 96, 96 Brigadier, 96D, 96DC, 96DS, 96G 96 Centurion	STX Tactical	Black	574-76-131	574-76-132
	STX Tactical	Foliage Green	574-76-541	574-76-542
	STX Tactical	Coyote Brown	574-76-761	574-76-762
	STX Tactical	OD Green	574-76-561	574-76-562
	STX Tactical	FDE Brown	574-76-551	574-76-552
Browning BDM 9mm				
EAA Witness 9mm, Witness .40SW				
FNH FNP 9mm, .40 FNX 9mm, .40				
Heckler & Koch P7M13				
Ruger KP-89, KP-89 DAO, KP-89 DAOW, KP-89 DC, KP-89 DW, KP-89 W, KP-91 DC, KP-91 DAO KP-95 D, KP-95 DAO, KP-944, KP-944 DAO KP-944 DAOW, KP-944 DC, KP-944 DW, KP-944 W, P-85, P-89, P-89 DC, P-89 DW, P-89 W, P-91 DC P-91 DAO, P-93, P-94, P-95 D, P-95 DAO				
Sig Sauer P226, P228, P226R MK25, P229				
Smith & Wesson 59, 459, 469, 659, 669, 910, 951, 4006, 4013TSW, 4026, 4053TSW, 4056TSW, 4553TSW, 5903, 5904, 5906, 5923, 5924, 5926, 5946, 6904, 6906, 6924, 6926, 6946				
Springfield Armory XD 9mm, .40				
Taurus PT-92, PT-92C, PT-99, PT-99C, PT-101				

Concealment Accessories

574 MAGAZINE HOLDER AND LIGHT POUCH, PADDLE (continued)

DESCRIPTION	FINISH	COLOR	RIGHT	LEFT
Beretta 8045F	STX Tactical	Black	574-83-131	574-83-132
	STX Tactical	Foliage Green	574-83-541	574-83-542
	STX Tactical	Coyote Brown	574-83-761	574-83-762
Glock 17, 19, 22, 23, 34, 35	STX Tactical	OD Green	574-83-561	574-83-562
	STX Tactical	FDE Brown	574-83-551	574-83-552
Heckler & Koch USP 9C, 40C P2000 12-Round				
Ruger SR9				
Sig Sauer SP2340, P250				
Smith & Wesson Sigma 9C, Sigma 40C, Sigma 9F, Sigma 40F SW9V, SW40V, M&P 9mm, .40, 9C				
Springfield Armory XD(M) 9mm, .40				
Taurus 24/7 9mm, .40				
Glock 20, 21, 29, 30	STX Tactical	Black	574-383-131	574-383-132
	STX Tactical	Foliage Green	574-383-541	574-383-542
	STX Tactical	Coyote Brown	574-383-761	574-383-762
Heckler & Koch USP 45	STX Tactical	OD Green	574-383-561	574-383-562
	STX Tactical	FDE Brown	574-383-551	574-383-552
Springfield Armory XD .45				

How to Order
Duty Holsters
Duty Accessories
Tactical Holsters
Tactical Accessories
Duty Belts
QAS
Speed Loaders
Light Systems
Concealment Holsters
Concealment Accessories
Competition
Apparel
Sales Support
Index/Price List

Concealment Accessories

590 OPEN TOP HANDCUFF CASE, PADDLE



- ▶ Thermal-formed laminate handcuff holder holds the handcuffs firmly and quietly in place
- ▶ Unique paddle design features a self-locking belt hook
- ▶ Fits up to 1.75" (45mm) belt widths
- ▶ Available in Plain Black finish

FINISH	COLOR	PART NO.
Plain	Black	590-2

L820 LEATHER PLAINCLOTHES BELT, 1.25" (32mm)



- ▶ Made of SafariLaminate™ with a vegetable-tanned leather support to accommodate holsters for larger handguns
- ▶ Features a solid brass or chrome buckle
- ▶ Available in Plain Black with solid brass or chrome buckle

FINISH	COLOR	BUCKLE	SIZE	PART NO.
Plain	Black	Brass	XX*	L820-XX-2
Plain	Black	Chrome	XX*	L820-XX-2C

*Model L820 is available in even sizes from 24"(61cm) to 44" (112cm). Sizes 46" (117cm) and above are available at additional cost (call for pricing). To order any belt, simply replace the XX in the part number with the proper size. Before measuring for any belt, please read "Ordering a Belt" in the "How to Order" section.

L830 LEATHER PLAINCLOTHES BELT, 1.5" (38mm)



- ▶ Made of SafariLaminate™ with a vegetable-tanned leather support to accommodate holsters for larger handguns
- ▶ Features a solid brass or chrome buckle
- ▶ Available in Plain Black with solid brass or chrome buckle

FINISH	COLOR	BUCKLE	SIZE	PART NO.
Plain	Black	Brass	XX*	L830-XX-2
Plain	Black	Chrome	XX*	L830-XX-2C

*Model L830 is available in even sizes from 24"(61cm) to 44" (112cm). Sizes 46" (117cm) and above are available at additional cost (call for pricing). To order any belt, simply replace the XX in the part number with the proper size. Before measuring for any belt, please read "Ordering a Belt" in the "How to Order" section.

TEAM SAFARILAND 2016 WORLD-CLASS RESULTS

The members of Team Safariland have been proving the superiority of Safariland® products for over four decades. Collectively they have won a world title since 1985 and most U.S. National titles. When they are not winning matches, Team Safariland members are on the road promoting Safariland products. Through demonstrations and training classes, they have shown law enforcement and military professionals that Safariland is the best duty and tactical gear in the world.

Scott Carnahan

- Team Safariland Captain
- 3-Time USPSA National Class Champion
- NRA Open Action Pistol Distinguished Badge #103
- 2009 NRA Bianchi Cup National Class Champion
- 2012 NRA USA Action Pistol World Team Member for the Bianchi Cup

Tom Campbell

- 2001 USPSA Limited 10 national Champion
- 1977-1988 Member of USPSA Shooting Team
- 1985 European Champion
- 1986 USPSA Team Captain
- 24 years at Safariland, over 46 years total in the industry

Julie Golob

- First & Only USPSA Seven Division Ladies National Champion
- 15-Time USPSA Ladies National Champion
- 3-Time Bianchi Cup Ladies Champion
- 7-Time Ladies World Speed Shooting Champion
- 4-Time IDPA Ladies National Champion

Doug Koenig

- 21-Time Masters Champion
- 2016 and 17-time Bianchi Cup Champion
- 2013 and 5-time European Bianchi Cup Champion
- 3-Time Steel Challenge World Speed Shooting Champion
- 1990 IPSC World Champion
- 2014 and 6-Time World Action Pistol Champion

Bobby McGee

- 2014 CA State IDPA – 1st Place ESP
- 2014 WA State IDPA - 1st Place ESR
- 2014 AZ State IDPA – ESR Division Champion
- 2013 IDPA Puerto Rico ESR National Champion
- 6-Time WA State IDPA Champion

Kenda Lenseigne

- 4-Time Overall World Champion - the only woman in CMSA history to accomplish this (beat out all the men)
- 13 World Records
- 2010 and 2011 CMSA Overall National Champion
- 2015 CMSA Hall of Fame Inductee

Kippi Leatham

- 2014 Western States Single Stack Classic Runner Up
- 2011 USPSA Area 3 Production Ladies Champion
- 2011 USPSA Ladies Production World Team, IPSC Silver Medalist
- 4-Time USPSA National Ladies Champion
- 4-Time USA IPSC Gold Team Member and Women's World Team Champion

Rob Leatham

- 28-Time USPSA / IPSC National Champion
- 8-Time IPSC World Champion
- 7-Time USPSA / IPSC Senior National Champion
- 4-Time Classic Nationals Aggregate Champion
- 9-Time NRA Bianchi Cup National Champion
- 8-Time Steel Challenge World Speed Shooting Champion

Maggie Reese

- 2016 US-IPSC Handgun Champion
- 3-Time National Champion USPSA Multi-Gun
- 2-Time National Team Member IPSC World Handgun
- Multi-time Ladies Champion at Superstition Mountain Mystery 3-Gun, MGM IronMan 3-Gun and Rocky Mountain 3-Gun
- Host of Modern Shooter on the Sportsman's Channel

Bill Rogers

- Author of "Be Fast, Be Accurate, Be The Best"
- Author of "Reactive Pistol Shooting" video by Panteao
- Author of "Reactive Rifle Shooting" videos by Panteao
- Rogers Shooting School - 1976 - present: owner, operator and lead instructor
- Inventor of and patented the "Kydex" holster
- Responsible for more than 40 patents in the firearms field

Michael Voigt

- 13-Time USPSA MultiGun National Champion
- 2-Time IPSC World Handgun Champion
- 7-Time IPSC World Champion Team member
- 5-Time International Tactical Rifle Champion
- 2-Time IPSC Continental Shotgun Champion
- 2-Time IPSC Continental Handgun Champion

Bob Vogel

- 2016 IPSC Standard Champion
- IPSC World Champion and 2-time IDPA World Champion
- 4-Time USPSA National Champion
- 8-Time IDPA National Champion
- 8-Time Indoor IDPA National Champion
- 4-Time Pro-Am Champion

How to Order
Duty Holsters
Duty Accessories
Tactical Holsters
Tactical Accessories
Duty Bats
QAS
Speed Loaders
Light Systems
Concealment Holsters
Concealment Accessories
Competition
Apparel
Sales Support
Index/Price List

Competition Holsters

002 CUP CHALLENGE FOR: REVOLVERS



FEATURES

- ▶ Features dual-tension screws on the holster body, one in back of cylinder and the other in back of barrel, allowing a balanced retention of the handgun
- ▶ Hook and loop lined belt tab provides a firm and adjustable carry when used with Safariland O32 hook lined competition belt
- ▶ Accommodates both scoped and non-scoped revolvers as well as most revolvers with standard, heavy, and slab side barrels
- ▶ Built-in removable muzzle strap protects front sights
- ▶ Available in STX Tactical® or STX Basketweave finish

DESCRIPTION	FINISH	COLOR	RIGHT	LEFT
Colt Anaconda, King Cobra, Python, Trooper 4" BBL (Fits custom BBLs up to 1")	STX Basket STX Tactical	Black Black	002-09-481 002-09-121	002-09-482 002-09-122
Colt Anaconda, King Cobra, Python 6" BBL (Fits custom BBLs up to 1")	STX Basket STX Tactical	Black Black	002-10-481 002-10-121	002-10-482 002-10-122
Colt Anaconda, King Cobra, Python 6" BBL (Stock BBL only)	STX Basket STX Tactical	Black Black	002-621-481 002-621-121	002-621-482 002-621-122
Ruger GP100, Security Six, Service Six, Speed Six 4" BBL (Fits custom BBLs up to 1")	STX Basket STX Tactical	Black Black	002-09-481 002-09-121	002-09-482 002-09-122
Ruger GP100, Security Six 6" BBL (Fits custom BBLs up to 1")	STX Basket STX Tactical	Black Black	002-10-481 002-10-121	002-10-482 002-10-122
Ruger GP100, Security Six 6" BBL (Stock BBL only)	STX Basket STX Tactical	Black Black	002-621-481 002-621-121	002-621-482 002-621-122
Smith & Wesson 10, 12, 13, 15, 19, 64, 65, 66, 67, 617, 648 K Medium Frame 4" BBL (Fits custom BBLs up to 1")	STX Basket STX Tactical	Black Black	002-09-481 002-09-121	002-09-482 002-09-122
Smith & Wesson 15, 19, 66, 617, 648 K Medium Frame 6" BBL (Fits custom BBLs up to 1")	STX Basket STX Tactical	Black Black	002-10-481 002-10-121	002-10-482 002-10-122
Smith & Wesson 15, 19, 66, 617, 648 K Medium Frame 6" BBL (Stock BBL only)	STX Basket STX Tactical	Black Black	002-621-481 002-621-121	002-621-482 002-621-122
Smith & Wesson 581, 586, 681, 686 L Medium Frame 4" BBL (Fits custom BBLs up to 1")	STX Basket STX Tactical	Black Black	002-09-481 002-09-121	002-09-482 002-09-122
Smith & Wesson 586, 686 L Medium Frame 6" BBL (Fits custom BBLs up to 1")	STX Basket STX Tactical	Black Black	002-10-481 002-10-121	002-10-482 002-10-122
Smith & Wesson 586, 686 L Medium Frame 6" BBL (Stock BBL only)	STX Basket STX Tactical	Black Black	002-621-481 002-621-121	002-621-482 002-621-122

Competition Holsters

002 CUP CHALLENGE FOR: REVOLVERS (continued)

DESCRIPTION	FINISH	COLOR	RIGHT	LEFT
Smith & Wesson 25, 27, 28, 29, 57, 629 N Large Frame 4" BBL (Fits custom BBLs up to 1")	STX Basket STX Tactical	Black Black	002-09-481 002-09-121	002-09-482 002-09-122
Smith & Wesson 25, 27, 28, 29, 57, 610, 625, 629, 657 N Large Frame 6" BBL (Fits custom BBLs up to 1")	STX Basket STX Tactical	Black Black	002-10-481 002-10-121	002-10-482 002-10-122
Smith & Wesson 25, 27, 28, 29, 57, 610, 629, 657 N Large Frame 6" BBL (Stock BBL only)	STX Basket STX Tactical	Black Black	002-621-481 002-621-121	002-621-482 002-621-122
Smith & Wesson All K, L, & N Frames 10 oz. underlug 6" BBL	STX Basket STX Tactical	Black Black	002-110-481 002-110-121	002-110-482 002-110-122
Smith & Wesson All K, L, & N Frames 7" BBL	STX Basket STX Tactical	Black Black	002-107-481 002-107-121	002-107-482 002-107-122
Taurus 66, 669, 689, M-80, M-82 4" BBL (Fits custom BBLs up to 1")	STX Basket STX Tactical	Black Black	002-09-481 002-09-121	002-09-482 002-09-122
Taurus 66, 669, 689 6" BBL (Fits custom BBLs up to 1")	STX Basket STX Tactical	Black Black	002-10-481 002-10-121	002-10-482 002-10-122
Taurus 66, 669, 689 6" BBL (Stock BBL only)	STX Basket STX Tactical	Black Black	002-621-481 002-621-121	002-621-482 002-621-122

How to Order
Duty Holsters
Duty Accessories
Tactical Holsters
Tactical Accessories
Duty Bats
QAS
Speed Loaders
Light Systems
Concealment Holsters
Concealment Accessories
Competition
Apparel
Sales Support
Index/Price List

Competition Holsters

014 OPEN CLASS COMPETITION HOLSTER



FEATURES

- ▶ Body machined out of aluminum to stabilize the handgun, yet offers little resistance for a secure and fast draw
- ▶ Ball joint on holster allows complete freedom of movement to customize the handgun draw
- ▶ Fully adjustable nosepiece accommodates barrels from 5" to 7.5" (13cm - 19cm)
- ▶ Fits a variety of competition handguns, with or without red dot or magnified optics
- ▶ Injection-molded adjustable trigger guard lock
- ▶ Front nosepiece designed to retain handgun and help prevent gun from being knocked out of the holster once seated
- ▶ Incorporates a simple push lock which secures weapon into the trigger block
- ▶ Belt loop fits up to 1.75" (45mm) widths
- ▶ Available in Black and Red finishes

DESCRIPTION	COLOR	RIGHT	LEFT
Caspian Arms 1911	Black Red	014-853-121 014-853-351	014-853-122 014-853-351
Colt 1911 Compensator, Combat Elite, Delta Elite, Delta Gold Cup, Gold Cup Nat'l Match, Government 1911			
CZ 75 85			
EAA Witness, Witness Compensator, Witness Gold Team, Witness Multi-Class Limited, Tangfolio			
JSL Spitfire, Spitfire MKII Competition			
Kimber 1911 Government models			
Nowling			
Sphinx			
Springfield Armory P-9			
STI 1911, 2011			
SVI Open, Limited			
Glock Plain 17, 22 4.5" BBL	Black Red	014-83-121 014-83-351	014-83-122 014-83-352
Glock 34, 35	Black Red	014-683-121 014-683-351	014-683-122 014-683-352
Sig Sauer Plain X5 5" BBL	Black Red	014-377-121 014-377-351	014-377-122 014-377-352
Smith & Wesson M&P 9mm 5" BBL	Black Red	014-819-121 014-819-351	014-819-122 014-819-352

COMPETITION DIVISIONS

Bianchi Open
 USPSA Open
 USPSA Limited
 USPSA Limited 10
 USPSA Multi-Gun ALL
 Steel Challenge Limited, Open

Competition Accessories

030 COMPETITION UNDERBELT, LOOP LINER

FEATURES

- ▶ Underbelt for 032 ELS Belt
- ▶ 1.5" (38mm) belt width
- ▶ Available in Black with web finish



DESCRIPTION	COLOR	SIZE	PART NO.
Plain	Black	XX*	030-XX-2

*Model 030 is available in even sizes from 24" (61cm) to 44" (112cm). Sizes 46" (117cm) and above are available at additional cost (call for pricing). To order any belt, simply replace the XX in the part number with the proper size, i.e., 030-34-2. Before measuring for any belt, please read "Ordering a Belt" in the "How to Order" section.

USPSA KIT

FEATURES

- ▶ Ball joint on kit allows complete freedom of movement to customize the handgun draw
- ▶ Adjustable height bar for personalized holster height
- ▶ Designed to fit 1.5" (38 mm) to 1.75" (45 mm) belt widths and locks down with set screws
- ▶ Designed for use with Model 5197 Concealment Holster



PATENTED

COLOR	PART NO.
Black	USPSA-KIT-2

014 ADAPTER KIT

FEATURES

- ▶ Allows for various mounting options for the 014 holster
- ▶ Available in Black

DESCRIPTION	COLOR	PART NO.
014 Adapter with 744BL Belt Loop	Black	014-744BL-2
014 Adapter with 745BL Belt Loop	Black	014-745BL-2
014 Adapter with ELS 34 Locking Fork	Black	014-ELS-2



How to Order
Duty Holsters
Duty Accessories
Tactical Holsters
Tactical Accessories
Duty Belts
OAS
Speed Loaders
Light Systems
Concealment Holsters
Concealment Accessories
Competition
Apparel
Sales Support
Index/Price List

Competition Accessories

032 ELS COMPETITION BELT



FEATURES

- ▶ Reinforced to hold heavy competition handguns and ammunition
- ▶ Hook-lined to attach to 030 underbelt
- ▶ Pre-cut holes to mount ELS 35 Receiver Plates in multiple locations and angles
- ▶ 1.75" (45mm) belt width
- ▶ Available in Nylon Look and Basketweave finishes

DESCRIPTION	COLOR	SIZE	PART NO.
Basket	Black	XX*	032-XX-18
Nylon Look	Black	XX*	032-XX-26
Plain	Red	XX*	032-XX-35

*Model 032 is available in even sizes from 24" (61cm) to 44" (112cm). Sizes 46" (117cm) and above are available at additional cost (call for pricing). To order any belt, simply replace the XX in the part number with the proper size, i.e., 032-34-18. Before measuring for any belt, please read "Ordering a Belt" in the "How to Order" section. We recommend using next larger size if using 029 underbelt with this belt.

Safariland's hook and loop Self Stick Kit (Model #083) works with the Models 030 & 032 Buckleless™ competition belts. This set of hook and loop squares is ideal for fastening accessories to these belts.

332 RANGE SERIES BELT 1.5" (38mm)



FEATURES

- ▶ Reinforced to hold heavy competition handguns and ammunition
- ▶ Non-slip inner lining
- ▶ Fits 1.5" (38 mm) belt widths
- ▶ Available in Cordura® Nylon

DESCRIPTION	COLOR	SIZE	PART NO.
Cordura® Nylon	Black	XX*	332-XX-78
Cordura® Nylon	Coyote	XX*	332-XX-74
Cordura® Nylon	Khaki	XX*	332-XX-75
Cordura® Nylon	Ranger Green	XX*	332-XX-73

* Model 332 is available in even sizes from 24" (60.96 cm) to 44" (111.76 cm). Sizes 46" (117 cm) and above are available at an additional cost (call for pricing). To order any belt, simply replace the XX in the part number with proper size, i.e., 332-24-78. Before measuring for any belt, please read "Ordering a Belt" in the "How to Order" section.

334 RIGID COMPETITION 1.5" (38mm)



FEATURES

- ▶ Reinforced to hold heavy competition handguns and ammunition
- ▶ Single Safariland branded keeper
- ▶ Hook liner for use with Safariland 030 Buckleless Competition Underbelt

FINISH	COLOR	SIZE	PART NO.
Nylon Look	Black	XX*	334-XX-26

* Model 334 is available in even sizes from 24" (60.96 cm) to 44" (111.76 cm). Sizes 46" (117 cm) and above are available at an additional cost (call for pricing). To order any belt, simply replace the XX in the part number with proper size, i.e., 334-24-26. Before measuring for any belt, please read "Ordering a Belt" in the "How to Order" section.

Competition Accessories

075-2 HEARING PROTECTOR HOLDER

FEATURES

- ▶ Clips on to belt
- ▶ Available in Black

COLOR	PART NO.
Black	075-2



077BL BELT LOOP ACCESSORY

FEATURES

- ▶ Constructed from a durable precision-formed, injection molded polymer
- ▶ Attaches easily with turn of a screw
- ▶ Available for 1.5" (38mm), 1.75" (45mm), and 2.25" (58mm) belts; please specify
- ▶ Fits Models 773 and 771
- ▶ For magazine pouches only

COLOR	RIGHT	LEFT
-------	-------	------

Black	077BL-0-1-150*	077BL-0-2-150*
Black	077BL-0-1-2*	077BL-0-2-2*

*-150 = 1.5" (38mm) belt loop. -175 = 1.75" (45mm) belt loop. -2 = 2.25" (58mm) belt loop



J-KTR, J-LP LOADING BLOCK

FEATURES

- ▶ Convenient trays hold wadcutter, semi-wadcutter or round nosed .38 or .357 ammunition
- ▶ Popular for all speedloaders

COLOR	PART NO.
-------	----------

Black	J-KTR
Black	J-LP

J-KTR accommodates loads for .38/357 Colt Trooper Mark III & V, S&W K frame
 J-LP accommodates loads for .38/357 S&W L frame, Colt Python O.M.M.,
 Old Model Troopers and O.P.

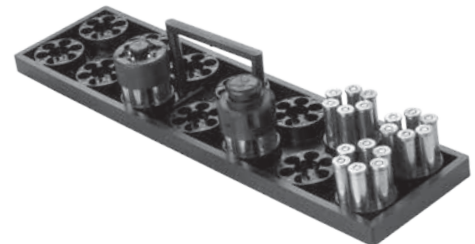

How to Order
Duty Holsters
Duty Accessories
Tactical Holsters
Tactical Accessories
Duty Belts
QAS
Speed Loaders
Light Systems
Concealment Holsters
Concealment Accessories
Competition
Apparel
Sales Support
Index/Price List

Competition Accessories

771 COMPETITION OPEN FRONT MAGAZINE POUCH



FEATURES

- ▶ Features two magazine tensioning screws on back side of the holster to adjust tension on both the middle and end of the magazine
- ▶ Sits against plastic rollers that reduce drag during draw
- ▶ Open-front design keeps index finger from touching the holder during reload, ensuring fast reload
- ▶ Available in STX Tactical® or STX Basketweave finishes

DESCRIPTION	FINISH	COLOR	RIGHT	LEFT
AMT Hardballer	STX Tactical STX Tactical	Red Red	771-53-141-150* 771-53-141-2*	771-53-142-150* 771-53-142-2*
Colt Combat Elite, Commander, Delta Elite, Delta Gold Cup, Gold Cup Nat'l Match, Government 1911, Officers' .45ACP	STX Basket STX Basket	Black Black	771-53-481-150* 771-53-481-2*	771-53-482-150* 771-53-482-2*
Kimber KIP45CUS	STX Tactical STX Tactical	Black Black	771-53-121-150* 771-53-121-2*	771-53-122-150* 771-53-122-2*
Sig Sauer P220, P220R Compact			*-150 = 1.5"(38mm) belt loop. -2 = 2.25"(58mm) belt loop	
Springfield Armory 1911-A1				
Beretta 8000, 8040, 92 Brigadier, 92D, 92DS, 92F, 92FC, 92FCDA, 92FS, 92FS Centurion, 92G, 96, 96 Brigadier, 96D, 96DC, 96DS, 96G, 96 Centurion	STX Tactical STX Tactical	Red Red	771-76-141-150* 771-76-141-2*	771-76-142-150* 771-76-142-2*
	STX Basket STX Basket	Black Black	771-76-481-150* 771-76-481-2*	771-76-482-150* 771-76-482-2*
	STX Tactical STX Tactical	Black Black	771-76-121-150* 771-76-121-2*	771-76-122-150* 771-76-122-2*
Browning BDM 9mm			*-150 = 1.5"(38mm) belt loop. -2 = 2.25"(58mm) belt loop	
EAA Witness 9mm, Witness 40SW				
FN FNP 9mm, .40 FNX 9mm, .40				
Heckler & Koch P7M13				
Ruger KP-89, KP-89 DAO, KP-89 DAOW, KP-89 DC, KP-89 DW, KP-89 W, KP-91 DC, KP-91 DAO, KP-95 D, KP-95 DAO, KP-944, KP-944 DAO, KP-944 DAOW, KP-944 DC, KP-944 DW, KP-944 W, P-85, P-89, P-89 DC, P-89 DW, P-89 W, P-91 DC, P-91 DAO, P-93, P-94, P-95 D, P-95 DAO				
Sig Sauer P226, P228, P226R MK25				
Smith & Wesson 59, 459, 469, 659, 669, 910, 915, 4006, 4013TSW, 4026, 4053TSW, 4056TSW, 4553TSW, 5903, 5904, 5906, 5923, 5924, 5926, 5946, 6904, 6906, 6924, 6926, 6946				
Springfield Armory P-9, XD 9mm, .40				
Taurus PT-92, PT-92C, PT-99, PT-99C, PT-101				
Beretta 92FCM	STX Tactical STX Tactical	Red Red	771-118-141-150* 771-118-141-2*	771-118-142-150* 771-118-142-2*
Heckler & Koch P7, P7M8	STX Basket STX Basket	Black Black	771-118-481-150* 771-118-481-2*	771-118-482-150* 771-118-482-2*
Kahr E9, K9 9mm, .40	STX Tactical STX Tactical	Black Black	771-118-121-150* 771-118-121-2*	771-118-122-150* 771-118-122-2*

To order with ELS Equipment Locking System components, use the following part numbers:

ELS 34 only 771-53-121-MS34
ELS 34 & ELS 35 771-53-121-MS36

Note: Order Mag Pouch by which hand you shoot with. Right for right, left for left.

Right handed shooters wear pouch on the left side. Reload with left hand. Opening is to the front. Bullets in magazine face forward for both right and left shooters. (Opposite for left hand.)

077BL replacement belt loop

Competition Accessories

771 COMPETITION OPEN FRONT MAGAZINE POUCH (continued)

DESCRIPTION	FINISH	COLOR	RIGHT	LEFT
Sig Sauer P225, P239	STX Tactical	Red	771-118-121-150*	771-118-122-150*
Smith & Wesson 39, 439, 639, 909, 3904, 3906, 3913, 3913LS, 3913NL, 3913TSW, 3914, 3914LS, 3953, 3953TSW, 3954, CS9	*150 = 1.5"(38mm) belt loop. -2 = 2.25" (58mm) belt loop			
Caspian EAA 38 Super	STX Tactical STX Tactical	Red Red	771-950-141-150* 771-950-141-2*	771-950-142-150* 771-950-142-2*
	STX Tactical STX Tactical	Black Black	771-950-121-150* 771-950-121-2*	771-950-122-150* 771-950-122-2*
	STX Basket STX Basket	Black Black	771-950-481-150* 771-950-481-2*	771-950-482-150* 771-950-482-2*
	*150 = 1.5"(38mm) belt loop. -2 = 2.25" (58mm) belt loop			
Beretta 8045F	STX Tactical STX Tactical	Red Red	771-83-141-150* 771-83-141-2*	771-83-141-150* 771-83-142-2*
Glock 17, 19, 22, 23, 34, 35	STX Basket STX Basket	Black Black	771-83-481-150* 771-83-481-2*	771-83-482-150* 771-83-482-2*
Heckler & Koch USP 9C, 40C, P2000 12-Round	STX Tactical STX Tactical	Black Black	771-83-121-150* 771-83-121-2*	771-83-122-150* 771-83-122-2*
Ruger SR9	*150 = 1.5" (38mm) belt loop. -2 = 2.25" (58mm) belt loop			
Sig Sauer SP2340, P250, SP2022				
Smith & Wesson Sigma 9C, Sigma 40C, Sigma 9F, Sigma 40F, SW9V, SW40V, M&P 9C, M&P 9mm, .40				
Springfield Armory XD(M) 9mm, .40				
Taurus 27/7 9mm, .40				
Glock 20, 21, 29, 30	STX Tactical STX Tactical	Red Red	771-383-141-150* 771-383-141-2*	771-383-142-150* 771-383-142-2*
Heckler & Koch USP .45	STX Tactical STX Tactical	Black Black	771-383-121-150* 771-383-121-2*	771-383-122-150* 771-383-122-2*
Smith & Wesson M&P .45	STX Basket STX Basket	Black Black	771-383-481-150* 771-383-481-2*	771-383-482-150* 771-383-482-2*
Springfield Armory XD .45	*150 = 1.5"(38mm) belt loop. -2 = 2.25" (58mm) belt loop			
McCormick/Tripp	STX Tactical STX Tactical	Red Red	771-850-141-150* 771-850-141-2*	771-850-142-150* 771-850-142-2*
Para-Ordnance P14	STX Tactical STX Tactical	Black Black	771-850-121-150* 771-850-121-2*	771-850-122-150* 771-850-122-2*
Strayer-Voigt Infinity	STX Basket STX Basket	Black Black	771-850-481-150* 771-850-481-2*	771-850-482-150* 771-850-482-2*
Smith & Wesson 645, 1006, 1026, 1046, 1066, 1076 1086, 4013, 4053, 4506, 4506-1, 4513TSW, 4516-1, 4516-2, 4526, 4536, 4546, 4553TSW, 4556, 4566, 457, 4576, 4586	STX Tactical STX Tactical	Red Red	771-23-141-150* 771-23-141-2*	771-23-142-150* 771-23-142-2*
	STX Tactical STX Tactical	Black Black	771-23-121-150* 771-23-121-2*	771-23-122-150* 771-23-122-2*
	STX Basket STX Basket	Black Black	771-23-481-150* 771-23-481-2*	771-23-482-150* 771-23-482-2*

How to Order
Duty Holsters
Duty Accessories
Tactical Holsters
Tactical Accessories
Duty Bats
QAS
Speed Loaders
Light Systems
Concealment Holsters
Concealment Accessories
Competition
Apparel
Sales Support
Index/Price List

Competition Accessories

744BL ACCESSORY BELT LOOP



FEATURES

- ▶ Replacement clip-on belt attachment for Model 774
- ▶ Fits belt widths from 1.5" (38mm) to 2.25" (58mm)

COLOR	PART NO.
Black	744BL-2

773 COMPETITION OPEN TOP MAGAZINE POUCH

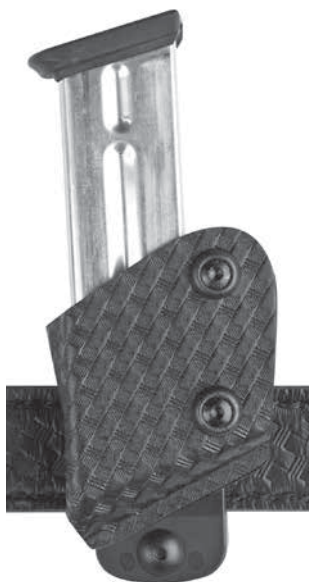

FEATURES

- ▶ Utilizes the 90° adjustable belt loop
- ▶ 2 sets of tension screws threaded through rollers for greater adjustment and lightning-fast reloads
- ▶ Closed low-cut front to help secure magazine and prevent it from being knocked out of the front of the pouch
- ▶ Built-up channel for clearance of the bullet during the draw
- ▶ Available in STX Tactical® or STX Basketweave finishes

DESCRIPTION	FINISH	COLOR	RIGHT	LEFT
AMT Hardballer	STX Tactical STX Tactical	Black Black	773-53-121-150* 773-53-121-2*	773-53-122-150* 773-53-122-2*
Colt Combat Elite, Commander, Delta Elite, Delta Gold Cup, Gold Cup Nat'l Match, Government 1911, Officers' .45ACP	STX Basket STX Basket STX Tactical STX Tactical	Black Black Red Red	773-53-481-150* 773-53-481-2* 773-53-141-150* 773-53-141-2*	773-53-482-150* 773-53-482-2* 773-53-142-150* 773-53-142-2*
Kimber KIP45CUS			* -150 = 1.5" (38mm) belt loop. -2 = 2.25" (58mm) belt loop	
Sig Sauer P220, P220R Compact				
Springfield Armory 1911-A1				
Beretta 8000, 8040, 92 Brigadier, 92D, 92DS, 92F, 92FC, 92FCDA, 92FS, 92FS Centurion, 92G, 96, 96 Brigadier, 96D, 96DC, 96DS, 96G, 96 Centurion	STX Tactical STX Tactical STX Basket STX Basket STX Tactical STX Tactical	Black Black Black Black Red Red	773-76-121-150* 773-76-121-2* 773-76-481-150* 773-76-481-2* 773-76-141-150* 773-76-141-2*	773-76-122-150* 773-76-122-2* 773-76-482-150* 773-76-482-2* 773-76-142-150* 773-76-142-2*
Browning BDM 9mm				
EAA Witness 9mm, Witness 40SW			* -150 = 1.5" (38mm) belt loop. -2 = 2.25" (58mm) belt loop	
FN FNP 9mm, .40, FNX 9mm, .40				
Heckler & Koch P7M13				

To order with ELS Equipment Locking System components, use the following part numbers:

ELS 34 only	773-53-121-MS34
ELS 34 & ELS 35	773-53-121-MS36

Note: Order Mag Pouch by which hand you shoot with. Right for right, left for left.

Right handed shooters wear pouch on the left side. Reload with left hand. Opening is to the rear. Bullets in magazine face forward for both right and left shooters.
(Opposite for left hand.)

(Additional models continued on page 263)

Competition Accessories

773 COMPETITION OPEN TOP MAGAZINE POUCH

DESCRIPTION FINISH COLOR RIGHT LEFT

(Please See Models Fits at the bottom of page 262)

Ruger

KP-89, KP-89 DAO, KP-89 DAOW, KP-89 DC, KP-89 DW, KP-89 W, KP-91 DC, KP-91 DAO,
 KP-95 D, KP-95 DAO, KP-944, KP-944 DAO, KP-944 DAOW, KP-944 DC, KP-944 DW,
 KP-944 W, P-85, P-89, P-89 DC, P-89 DW, P-89 W, P-91 DC, P-91 DAO, P-93, P-94, P-95 D, P-95 DAO

Sig Sauer

P226, P228

Smith & Wesson

59, 459, 469, 659, 669, 910, 915, 4006, 4013TSW, 4026, 4053TSW, 4056TSW, 4553TSW, 5903, 5904,
 5906, 5923, 5924, 5926, 5946, 6904, 6906, 6924, 6926, 6946

Springfield Armory

P-9, XD 9mm, 40

Taurus

PT-92, PT-92C, PT-99, PT-99C, PT-101

Beretta	STX Tactical	Black	773-83-121-150*	773-83-122-150*
8045	STX Tactical	Black	773-83-121-2*	773-83-122-2*

Glock	STX Tactical	Red	773-83-141-150*	773-83-142-150*
17, 19, 22, 23, 34, 35,	STX Tactical	Red	773-83-141-2*	773-83-142-2*

Heckler & Koch	STX Basket	Black	773-83-481-150*	773-83-482-150*
USP 9C, 40C, P2000 12-Round	STX Basket	Black	773-83-481-2*	773-83-482-2*

Ruger

SR9

*-150 = 1.5"(38mm) belt loop. -2 = 2.25" (58mm) belt loop

Sig Sauer

SP2340, P250, SP2022

Smith & Wesson

Sigma 9C, Sigma 40C,
 Sigma 9F, Sigma 40F, SW9V,
 SW40V, M&P 9C,
 M&P 9mm, .40

Springfield Armory

XD(M) 9mm, .40

Glock	STX Tactical	Black	773-383-121-150*	773-383-122-150*
20, 21, 29, 30	STX Tactical	Black	773-383-121-2*	773-383-122-2*

Heckler & Koch	STX Basket	Black	773-383-481-150*	773-383-482-150*
USP .45	STX Basket	Black	773-383-481-2*	773-383-482-2*

Smith & Wesson	STX Tactical	Red	773-383-141-150*	773-383-142-150*
M&P .45	STX Tactical	Red	773-383-141-2*	773-383-142-2*

Springfield Armory	STX Tactical	Red	773-383-141-150*	773-383-142-150*
XD .45	STX Tactical	Red	773-383-141-2*	773-383-142-2*

*-150 = 1.5"(38mm) belt loop. -2 = 2.25" (58mm) belt loop

McCormick/Tripp	STX Tactical	Black	773-850-121-150*	773-850-122-150*
	STX Tactical	Black	773-850-121-2*	773-850-122-2*

Para-Ordnance	STX Basket	Black	773-850-481-150*	773-850-482-150*
P14	STX Basket	Black	773-850-481-2*	773-850-482-2*

Strayer-Voigt	STX Tactical	Red	773-383-141-150*	773-383-142-150*
Infinity	STX Tactical	Red	773-383-141-2*	773-383-142-2*

*-150 = 1.5"(38mm) belt loop. -2 = 2.25" (58mm) belt loop

Caspian	STX Tactical	Black	773-950-121-150*	773-950-122-150*
Hi Capacity Magazine	STX Tactical	Black	773-950-121-2*	773-950-122-2*

EAA	STX Basket	Black	773-950-481-150*	773-950-482-150*
38 Super	STX Basket	Black	773-950-481-2*	773-950-482-2*

	STX Tactical	Red	773-950-141-150*	773-950-142-150*
	STX Tactical	Red	773-950-141-2*	773-950-142-2*

*-150 = 1.5"(38mm) belt loop. -2 = 2.25" (58mm) belt loop

How to Order
 Duty Holsters
 Duty Accessories
 Tactical Holsters
 Tactical Accessories
 Duty Belts
 QAS
 Speed Loaders
 Light Systems
 Concealment Holsters
 Concealment Accessories
 Competition
 Apparel
 Sales Support
 Index/Price List

Competition Accessories

774 RIFLE MAGAZINE POUCH



FEATURES

- ▶ Clip-on belt attachment to fit 1.5" (38mm) to 2.25" (58mm) belts
- ▶ Adjustable for carry angle
- ▶ SafariLaminate™ thermal-molded construction with tension device
- ▶ Ambidextrous
- ▶ Can be ordered with ELS 34 Locking Fork attached

DESCRIPTION	FINISH	COLOR	PART NO.
Colt AR15, M4	STX Tactical	Black Foliage Green Coyote Brown FDE Brown	774-215-13 774-215-54 774-215-76 774-215-55
Heckler & Koch 416			
Heckler & Koch G36	STX Tactical	Black Foliage Green Coyote Brown FDE Brown	774-212-13 774-212-54 774-212-76 774-212-55
SPC 6.8	STX Tactical	Black Foliage Green OD Green Coyote Brown FDE Brown	774-213-13 774-213-54 774-213-56 774-213-76 774-213-55
Heckler & Koch MP5	STX Tactical	Black Foliage Green Coyote Brown FDE Brown	774-216-13 774-216-54 774-216-76 774-216-55
FN FN308	STX Tactical	Black Foliage Green Coyote Brown FDE Brown	774-308-13 774-308-54 774-308-76 774-308-55
Springfield Armory M1A			

776 COMPETITION MAGNETIC MAGAZINE POUCH



FEATURES

- ▶ Magazines are oriented "bullets out" to save space on belt
- ▶ Outer tension screws are eliminated for a slim, low profile
- ▶ Designed with internal magnets to be used as a tension device
- ▶ Durable nylon construction
- ▶ Hook and loop closure
- ▶ Includes a snap loop attachment to hold flap in place
- ▶ Available with 744BL Belt Clip or ELS 34 Locking Fork

DESCRIPTION	FINISH	COLOR	CLOSURE	PART NO.
AMT Hardballer	Nylon Look	Black	Magnetic	776-53-4BL
Beretta 92F, 92FM, 92DM				
Colt Comabt Elite, Commander, Delta Elite, Delta Gold Cup, Gold Cup Nat'l Match, Government 1911, Officers' ACP				
Kimber KIP45CUS				
Sig Sauer P220, P220 Compact				
Smith & Wesson 39, 439, 639, 909, 3904, 3906, 4013, 4053, CS9				

Competition Accessories

6005-12 SHOTGUN SPEEDLOADER HOLDER

FEATURES

- ▶ Designed to be worn on the thigh
- ▶ Provides quick access to up to 5 shotgun Speedloaders
- ▶ Cup and retention clip system keeps loaders stable, even while running
- ▶ Includes ELS 34 Locking Fork on a leg strap to work in conjunction with 032 ELS Competition Belt

COLOR	PART NO.
Black	6005-12-2



080-12 SHOT SHELL HOLDER, 12-GAUGE

FEATURES

- ▶ Molded shotgun shell holder holds (2) 12-gauge shells
- ▶ Belt clip features an extended bottom hook for security
- ▶ Fits belts up to 2.25" (58mm) wide

COLOR	PART NO.
Black	080-2



081-12 RIVET MOUNT SHOT SHELL HOLDER

FEATURES

- ▶ Molded shotgun shell holder holds (2) 12-gauge shells

COLOR	PART NO.
Black	081-12



How to Order
Duty Holsters
Duty Accessories
Tactical Holsters
Tactical Accessories
Duty Belts
QAS
Speed Loaders
Light Systems
Concealment Holsters
Concealment Accessories
Competition
Apparel
Sales Support
Index/Price List

Competition Accessories

085 4-ROUND SHOTGUN SHELL HOLDER

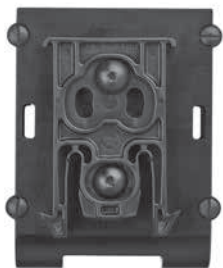

PATENT PENDING

Front

FEATURES

- ▶ Provides (4) 12-gauge shells when needed
- ▶ All shells can be grasped and employed at once
- ▶ Metal tension device provide solid retaining system to hold shells
- ▶ Available in 4 configurations: ELS Fork; 744BL Belt Clip; ELS 34/35 Fork and Plate; or plain for direct leg shroud mounting
- ▶ Designed for use with 2.75" shells

DESCRIPTION	COLOR	PART NO.
Belt Clip	Black	085-12-2
Tactical Mounting Point	Black	085-12-23
ELS 34 Fork	Black	085-12-23-MS34
ELS 34 For & ELS 35 Plate	Black	085-12-23-MS36

086 SHOTGUN SHELL HOLDER

FEATURES

- ▶ Holds (2), (4), (6) or (8) shotgun shells
- ▶ Unique retaining plate keeps the shotgun shells from dislodging, and are quickly removed but are quickly removed
- ▶ Sturdy aluminum back plates which allows for ride height and cant adjustments
- ▶ Available in 4 configurations: ELS Fork; 744BL Belt Clip; ELS 34/35 Fork and Plate; or plain for direct leg shroud mounting



DESCRIPTION	COLOR	PART NO.
Shotgun Shell Holders - 2	Black	086-22-2-745BL
Shotgun Shell Holder w/ ELS 34	Black	086-22-2-MS34
Shotgun Shell Holder w/ 744BL	Black	086-22-2-744BL
Shotgun Shell Holders - 2	Red	086-22-35-745BL
Shotgun Shell Holder w/ ELS 34	Red	086-22-35-MS34
Shotgun Shell Holder w/ 744BL	Red	086-22-35-744BL
Shotgun Shell Holder - 2 (4)	Black	086-24-2-745BL
Shotgun Shell Holder w/ ELS 34	Black	086-24-2-MS34
Shotgun Shell Holder w/ 744BL	Black	086-24-2-744BL
Shotgun Shell Holder - 2 (4)	Red	086-24-35-745BL
Shotgun Shell Holder w/ ELS 34	Red	086-24-35-MS34
Shotgun Shell Holder w/ 744BL	Red	086-24-35-744BL
Shotgun Shell Holder - 2 (6)	Black	086-26-2-745BL
Shotgun Shell Holder w/ ELS 34	Black	086-26-2-MS34
Shotgun Shell Holder w/ 744BL	Black	086-26-2-744BL
Shotgun Shell Holder - 2 (6)	Red	086-26-35-745BL
Shotgun Shell Holder w/ ELS 34	Red	086-26-35-MS34
Shotgun Shell Holder w/ 744BL	Red	086-26-35-744BL
Shotgun Shell Holder - 4	Black	086-4-2-745BL
Shotgun Shell Holder w/ ELS 34	Black	086-4-2-MS34
Shotgun Shell Holder w/ 744BL	Black	086-4-2-744BL
Shotgun Shell Holder - 4	Red	086-4-35-745BL
Shotgun Shell Holder w/ ELS 34	Red	086-4-35-MS34
Shotgun Shell Holder w/ 744BL	Red	086-4-35-744BL
Shotgun Shell Holder - 8	Black	086-8-2-745BL
Shotgun Shell Holder w/ ELS 34	Black	086-8-2-MS34
Shotgun Shell Holder w/ 744BL	Black	086-8-2-744BL
Shotgun Shell Holder - 8	Red	086-8-35-745BL
Shotgun Shell Holder w/ ELS 34	Red	086-8-35-MS34
Shotgun Shell Holder w/ 744BL	Red	086-8-35-744BL

Competition Accessories

333 TRIPLE SPEEDLOADER HOLDER

FEATURES

- ▶ The 333 Triple Speedloader Holder features external clips and molded loader cups for ultra-quick access. Ideal for competition use.

BELT LOOP	COLOR	PART NO.
1.75" (45mm)	Black	333-X*-2-175
2.25" (58mm)	Black	333-X*-2

*Model 333 is available to fit all three versions of our Speedloaders. To determine the proper part number, substitute one of the two fit codes below for the X in the part number, i.e., 333-2.
2 - S&W K frame, Ruger Security Six, Service Six, Speed Six, Taurus 66, 669, 689
3 - S&W L frame, Colt Python, Ruger GP100



How to Order
Duty Holsters
Duty Accessories
Tactical Holsters
Tactical Accessories
Duty Belts
OAS
Speed Loaders
Light Systems
Concealment Holsters
Concealment Accessories
Competition
Apparel
Sales Support
Index/Price List

Competition Accessories

4553 DUAL HANDGUN CASE



open view

FEATURES

- ▶ Rugged ballistic pack cloth construction
- ▶ Full interior closed-cell foam surrounded by soft lining for safe handgun storage
- ▶ Four outside magazine/accessory pouches
- ▶ Wrap-around handles
- ▶ Dual concealed pockets to individually protect handgun
- ▶ Carry up to 6" handguns
- ▶ Available in Black

DESCRIPTION	COLOR	PART NO.
12" Premium Dual Handgun Case	Black	4553-4

How to Order
Duty Holsters
Duty Accessories
Tactical Holsters
Tactical Accessories
Duty Belts
OAS
Speed Loaders
Light Systems
Concealment Holsters
Concealment Accessories
Competition
Apparel
Sales Support
Index/Price List

Competition Accessories

4555 SHOOTERS' RANGE BAG

FEATURES

- ▶ Removable center carry compartment has zippered, padded side panels for 4 separate handgun compartments
- ▶ Adjustable hook and loop dividers to personalize accessory space
- ▶ Magazine pouches conveniently sewn into main storage area
- ▶ Two large exterior pockets and a fully lined interior
- ▶ Full-wrap carry handles make it easy to move gear to different shooting stations
- ▶ Outer carry bag has dual zipper top for easy access and full coverage, flat side zipper pocket, ID window, and large outside zippered pocket for towel, shooting glasses or hearing protection

DESCRIPTION	COLOR	PART NO.
Shooters' Range Bag	Black	4555-4



Outside dimensions:
14" x 9" x 10"

Open view

4556 3-GUN COMPETITION CASE

FEATURES

- ▶ Rugged ballistic pack cloth construction
- ▶ Heavy-duty lockable zippers, two adjustable outside accessory pouches
- ▶ Large dual handgun/accessory pouch with individual hook and loop enclosed handgun storage areas and 4 pistol mag pouches large enough for extended magazines
- ▶ Closed-cell protective foam padding and 2-in. perimeter lip
- ▶ Assorted accessory pockets inside case
- ▶ Adjustable padded shoulder harness for shoulder carry
- ▶ Includes adjustable backpack-style carry straps that tuck away in storage pocket when not in use
- ▶ Three modes of carry - luggage style handles, shoulder strap, or backpack-style carry
- ▶ Unique zippered barrel expansion slot on side of case can be opened to allow use of longer firearms (up to 51") while still fully encompassing weapon muzzle
- ▶ 46" overall length (with expansion slot)



DESCRIPTION	COLOR	PART NO.
3-Gun Case	Black	4556-4

How to Order
Duty Holsters
Duty Accessories
Tactical Holsters
Tactical Accessories
Duty Belts
QAS
Speed Loaders
Light Systems
Concealment Holsters
Concealment Accessories
Competition
Apparel
Sales Support
Index/Price List

Apparel

TS-2900 SAFARILAND® LONG-SLEEVE PERFORMANCE T-SHIRT



FEATURES

- ▶ Team Safariland competition long-sleeved shirt
- ▶ Moisture-wicking fabric helps keep the wearer cool in hot environments and warm in cold ones
- ▶ Black with silk-screened Safariland® logo on front, back, and forearms
- ▶ Available in sizes S-XXL

COLOR	SIZE	PART NO.
Black	Small	TS-2901
Black	Medium	TS-2902
Black	Large	TS-2903
Black	XLarge	TS-2904
Black	XXLarge	TS-2905

TS-3200 SAFARILAND® PERFORMANCE T-SHIRT



FEATURES

- ▶ Moisture-wicking fabric helps keep the wearer cool in hot environments and warm in cold ones
- ▶ Black with silk-screened Safariland® logo on upper front chest and upper back
- ▶ Available in sizes S-XXL

COLOR	SIZE	PART NO.
Black	Small	TS-3201
Black	Medium	TS-3202
Black	Large	TS-3203
Black	XLarge	TS-3204
Black	XXLarge	TS-3205

TS-6600 SAFARILAND® MEN'S PERFORMANCE POLO SHIRT

FEATURES

- ▶ Moisture-wicking fabric helps keep the wearer cool in hot environments and warm in cold ones
- ▶ Black with embroidered Safariland® logo on upper left chest
- ▶ Available in sizes S-XXL

COLOR	SIZE	PART NO.
Black	Small	TS-6601
Black	Medium	TS-6602
Black	Large	TS-6603
Black	XLarge	TS-6604
Black	XXLarge	TS-6605
White	Small	TS-6620
White	Medium	TS-6621
White	Large	TS-6622
White	XLarge	TS-6623
White	XXLarge	TS-6624



TS-6610 SAFARILAND® WOMEN'S PERFORMANCE POLO SHIRT

FEATURES

- ▶ Moisture-wicking fabric helps keep the wearer cool in hot environments and warm in cold ones
- ▶ Black with embroidered Safariland® logo on upper left chest
- ▶ Available in sizes S-XXL

COLOR	SIZE	PART NO.
Black	Small	TS-6611
Black	Medium	TS-6612
Black	Large	TS-6613
Black	XLarge	TS-6614
Black	XXLarge	TS-6615



TS-9250/TS-9255 SAFARILAND® HAT

FEATURES

- ▶ Adjustable size fits all
- ▶ Low-profile design
- ▶ Embroidered Safariland logo on front and Safariland on back

COLOR	PART NO.
Black-Safariland Logo	TS-9250-5
Tan-Safariland Logo	TS-9255-5



Sales Support

BAN-200 SAFARILAND® BANNER



DESCRIPTION	PART NO.
Banner	Black Background, Red Lettering 9' x 3' BAN-200-9 3' x 3' BAN-200-3

SAF-CUP-2 SAFARILAND® TUMBLER



DESCRIPTION	PART NO.
Stainless Steel tumbler 16 oz with plastic liner and top, laser engraved with Safariland Logo	SAF-CUP-2

SAF-MUG-2 SAFARILAND® MUG



DESCRIPTION	PART NO.
Ceramic Coffee Mug (17 oz) with Safariland red and liquid gold Logo on two sides.	SAF-CUP-MUG

TV-DVD TRAINING DVD'S



DESCRIPTION	PART NO.
ALS Training	TV-1012D
Duty Holsters Review	TV-1015D
070/0701 Holsters (16 minutes)	TV-1023D
Speedloader Training (11 minutes)	TV-1001D
Competition (20 minutes)	TV-1025D
Retention and Evaluation	TV-1007D
Combination Loop (120 minutes)	TV-1009D
SLS Training DVD	TV-1004D
EDW Training (3 minutes)	TV-1006D
MLS/QLS Training (22 minutes)	TV-1003D
Concealment Holsters and Long Gun Accessories	TV-1016D
Tactical Holster Review	TV-1008D

935 SAFARILAND COASTERS



- ▶ Safariland impala logo
- ▶ Vegetable premium tanned leather
- ▶ Suede lined with border stitching

DESCRIPTION	PART NO.
Set of six coasters and holder	Plain Tan 13343

IN-STORE SUPPORT ITEMS

DESCRIPTION	PART NO.
Decal, Safariland 3"	SAF-DECAL-3
Decal, Safariland Window 6"	SAF-DECAL
Safariland Lapel Pin	SAF-PIN-2
Cut-Away, Model 070 SSIII Holster	070-CA
Cut-Away, Model 295 Holster	295-CA
Cut-Away, Laminate Cut-away	LAM-CA
Cut-Away, 6360	6360-CA
Cut-Away, 6360 M&P	6360CA-219

002	Cup Challenge Holster, for Revolvers	276	568	Custom Fit Paddle and Belt Loop Holster Combo, for Pistols	199
077BL	Belt Loop Accessory	281	568	Custom Fit Paddle and Belt Loop Holster Combo, for Revolvers	204
014	Open Class Competition Holster	278	569	Custom Fit Belt Clip Holster, for Pistols	199
030	Competition Underbelt, Loop Liner, 1.5" (38mm)	279	569	Custom Fit Belt Clip Holster, for Revolvers	204
031	D-Ring Belt w/ Loop Lining, 1.5" (38mm)	175	572	Open Top Double Magazine Pouch, Paddle	268
032	ELS Competition Belt, 1.5" (38mm)	280	573	Open Top Magazine & Handcuff Pouch	270
070	SSIII™ Mid-Ride, Level III Retention™ Holster, for Pistols	15	574	Magazine Holder and Light Pouch, Paddle	272
070	SSIII™ Mid-Ride, Level III Retention™ Holster, for Revolvers	19	575	GLS™ Pro-Fit™ Inside-Waistband Holster	206
0705	Low-Ride, Level III Retention™ Holster, for Pistols	15	576	GLS™ Pro-Fit™ Belt Slide Holster	207-210
0705	Low-Ride, Level III Retention™ Holster, for Revolvers	19	577	GLS™ Pro-Fit™ Belt Loop Holster	207-210
074	Open Top Single Magazine Pouch, Paddle	264	578	GLS™ Pro-Fit™ Paddle & Belt Loop Combo Holster	207-210
075-2	Hearing Protection Holder	281	579	GLS™ Pro-Fit™ Belt Clip Holster	207-210
079	Open Top Double Magazine Pouch, Snap-On	266	590	Open Top Handcuff Case, Paddle	274
090/090H	Handcuff Case, Open Top	78	654	Belt Keeper, Slotted, 4-Snap	74
090-1	Handcuff Case, Open Top	78	655	Belt Keeper, Heavy Duty, 2-Snap	74
080-12	Shot Shell Holder, 12-Gauge	287	690	Handcuff Strap, 1-Snap	76
081-12	Rivet Mount Shotgun Shell Holder	287	692S	Baton Ring, w/ Snap	72
085	4 Round Shotgun Shell Holder	288	730	Flashlight Ring, Heavy Duty, w/ Snap	75
086	Shotgun Shell Holder	288	744BL	Accessory Clip-On Belt Loop	284
2	Hi-Ride, Level I Retention™ Holster, for Pistols	13	761	Radio Holder, Adjustable	81
18	Inside-The-Waistband Holster, for Pistols	192	762	Radio Holder, Swivel	81
18	Inside-The-Waistband Holster, for Revolvers	193	763	Radio Holder, Universal Fit	81
22	Wallet Holster	193	764	Tape Recorder Holder, Adjustable	82
25	Inside-The-Pocket Holster, for Pistols	194	766	Radio Holder	82
25	Inside-The-Pocket Holster, for Revolvers	194	771	Competition Open Front Magazine Pouch	282
27	Inside-The-Pants Holster, for Pistols	195	773	Competition Open Top Magazine Pouch	284
27	Inside-The-Pants Holster, for Revolvers	195	774	Rifle Magazine Pouch	165, 286
33	Surgical Glove Holder	80	775	Slimline Open Top Triple Magazine Pouch	100, 164
34	Open Top OC Holder	82	776	Competition Magnetic Magazine Holder	286
35	Baton Holder	71, 161	777	Slimline Triple Magazine Pouch	101, 164
36	Open Top OC Holder	83	872	Suede Lined Contour Duty Belt, 2.25" (58mm)	178
37	Open Top Mace®/OC Spray Holder	83, 161	875	Stitched Edge w/ Buckle, 2.25" (58mm)	179
38	OC Spray Holder	84, 161	942	Contour Style Duty Belt, w/ Hook and Loop System, 2" (50mm) or 2.25" (58mm)	179
38, 38HS	Mace®/OC Spray Holder, Top Flap	84, 161	942P	Contour Duty Belt w/o Hook and Loop, 2.25" (58mm)	179
40	Distraction Device® Holder	162	992	Buckleless™ Reversible, Contour Belt, 1.5" (38mm)	180
51	Garrison w/ Square Buckle 1.75" (45mm)	175	999	Garrison Belt, Hook and Loop Closure, 1.5" (38mm)	180
62	Belt Keeper, Hidden Snap	73	1053	ALS® Universal Shoulder Holster, for Pistols	212
63	Belt Keeper, Slotted, 2-Snap	73	2005	Low-Ride, Level I Retention™ Holster, for Pistols	20
65	Belt Keeper, 2-Snap	73	2005	Low-Ride, Level I Retention™ Holster, for Revolvers	24
67	Baton Ring, w/o Snap	72	2955	Low-Ride, Level II Retention™ Holster, Pistols Only	25
71	Injection Molded Single Magazine Pouch	259	4320	Padded Belt Liner	181
71MSA	MOLLE Sliding Adapter	259	4325	Nylok® Pro Buckleless™ Reversible Belt, Loop Lined	181
72	Double Magazine and Cuff Pouch	86		Replacement Belt Buckles	182
73	Double Duty Open Top Magazine Pouch	87	4330	Padded Belt Liner	181
74	Magazine and Rifle Pouch	89	4332	Ballistic Nylon Tactical Belt w/ ELS Mounting Holes	166
75	Open Top Double Magazine Pouch	90	4552	Dual Rifle Case	167
76	Single Magazine Pouch	92, 162	4553	Dual Handgun Case	290
77	Double Magazine Pouch	95, 163	4555	Shooters' Range Bag	291
78	Slimline Double Magazine Pouch	97, 163	4556	3-Gun Case	291
79	Slimline Open Top Double Magazine Pouch	98, 164	4832	Light Weight Duty Belt	182
81	Open Top Lightweight Magazine Pouch	260	5186	Open Top Hi-Ride Concealment Belt Slide Holster, for Pistols	216
87	Suede Lined Belt w/ Buckle, 2.25" (58mm)	175	5186	Open Top Hi-Ride Concealment Belt Slide Holster, for Revolvers	218
87V	Suede Lined Hook and Loop System, 2.25" (58mm)	175	5188	Concealment Paddle Holster, for Pistols	216
90/90H	Handcuff Case, Open Top, Formed	79	5188	Concealment Paddle Holster, for Revolvers	218
94	Buckleless™ w/ Hook and Loop System, 2.25" (58mm)	176	5195	Range Series Open Top Low-Ride Holster, for Pistols	219
94P	Buckleless™ w/o Hook and Loop, 2.25" (58mm)	176	5196	Open Top Concealment Hi-Ride Belt Slide Holster, for Pistols	221
99	Buckleless™ Reversible, 1.5" (38mm)	177	5196	Open Top Concealment Hi-Ride Belt Slide Holster, for Revolvers	224
123	Horizontal Magazine Pouch	262	5197	Open Top Belt Loop Holster w/ Detent Holster, for Pistols	225
135	Baton Holder	72	5198	Open Top Paddle and Belt Loop Combo w/ Detent Holster, for Pistols	221
146	Border Patrol w/ Buckle, 2.25" (58mm)	177	5198	Open Top Paddle and Belt Loop Combo w/ Detent Holster, for Revolvers	224
146V	Border Patrol Belt w/ Hook and Loop System, 2.25" (58mm)	178	5199	Open Top Belt Clip Holster w/ Detent Holster, for Pistols	221
168	Key Ring, 2-Snap	75	5199	Open Top Belt Clip Holster w/ Detent Holster, for Revolvers	224
169S	Key Ring, 1-Snap	76	6004	SLS Tactical Holster, for Pistols	105
170	Silent Key Holder	76	6004	SLS Tactical Holster, for Revolvers	119
190	Single Handcuff Case	164	6004-4	Leg Shroud Only	171
190/190H	Handcuff Case, Top Flap, 1-Snap	79	6004-6	Double Strap Leg Shroud	168
200	Top Gun™ Mid-Ride, Level I Retention™ Holster, for Pistols	20	6004-8	Small MOLLE Adapter Plate	171
200	Top Gun™ Mid-Ride, Level I Retention™ Holster, for Revolvers	24	6004-10	Single Strap Leg Shroud	168
277	Quad Magazine Pouch	99	6004-11	Vertical Leg Strap Only	171
290, 290H	Double Handcuff Case, Top Flap, 1-Snap	80	6004-14	Single Strap Leg Shroud Only	171
295	Mid-Ride, Level II Retention™ Holster, Pistols Only	25	6004-110	Lightweight Leg Shroud	169
306	Open Top Mini Flashlight Holder	77	6004-114	Lightweight Leg Shroud Only	171
307	EDW Cartridge Holder	77, 165	6004DFA	Drop Flex Adapter	169
308	Hand-Held Flashlight Holder	78, 165	6004UFA	Universal Flex Adapter	170
332	Range Series Belt	280	6004RDS	SLS Tactical Holster, for Pistols	118
333	Triple Speedloader Holder	188	6005	SLS Tactical Holster w/ Quick-Release, for Pistols	105
334	Rigid Competition Belt	280	6005	SLS Tactical Holster w/ Quick-Release for Revolvers	119
340	Double Speedloader Pouch, 2-Snap	189	6005-6	Double Strap Leg Shroud w/ Quick-Release	172
371	Split-Six Speedloader Pouch, Leather, 1.5"-1.75"	189	6005-7	Buckle Portion of Quick-Release Leg Strap	173
			6005-10	Single Strap Leg Shroud w/ Quick-Release	172
			6005-11	Quick-Release Leg Strap Only	173
566	Custom Fit Hi-Ride, for Pistols	199	6005-12	Shotgun Speedloader Holder	287
566	Custom Fit Hi-Ride, for Revolvers	204	6005-23	MLS Accessory Fork on Quick-Release Strap	173
567	Custom Fit Belt Loop Holster, for Pistols	199	6005RDS	SLS Tactical Holster w/Quick-Release, for Pistols	118
567	Custom Fit Belt Loop Holster, for Revolvers	204			

Index

LISTED BY MODEL NUMBER

How to Order	Duty Holsters	Duty Accessories	Tactical Holsters	Tactical/ Accessories	Duty Belts	OAS	Speed Loaders	Light Systems	Concealment Holsters	Concealment Accessories	Competition	Apparel	Sales Support	Index/ Price List
	6005-110	Lightweight Leg Shroud w/ Quick-Release	172											
	6005VE	Quick-Release Buckle w/Enhanced Hook & Loop Belt Attachment	173											
	6009-6	Double Strap Leg Shroud w/ D-Ring	173											
	6009-10	Single Strap Leg Shroud w/ D-Ring	174											
	6009-11	D-Ring Leg Strap Only	174											
	6009-110	Lightweight Leg Shroud w/ D-Ring	174											
	6009VE	D-Ring Strap w/Enhanced Hook & Loop Belt Attachment	174											
	6034	SLS Military Tactical Holster, for Pistols	121											
	6035	SLS Military Tactical Holster w/ Quick-Release, for Pistols	121											
	6230	SLS Military Mid-Ride Holster, for Pistols	122											
	6235	SLS Military Low-Ride Holster, for Pistols	122											
	6280	SLS Mid-Ride, Level II Retention™ Holster, for Pistols	27											
	6280	SLS Mid-Ride, Level II Retention™ Holster, for Revolvers	39											
	6280RDS	SLS Mid-Ride, Level II Retention™ Holster, for Pistols	40											
	6282	SLS Hi-Ride, Level II Retention™ Holster, for Pistols	27											
	6282	SLS Hi-Ride, Level II Retention™ Holster, for Revolvers	39											
	6282RDS	SLS Hi-Ride, Level II Retention™ Holster, for Pistols	40											
	6285	SLS Low-Ride, Level II Retention™ Holster, for Pistols Only	27											
	6285	SLS Low-Ride, Level II Retention™ Holster, for Revolvers	39											
	6285RDS	SLS Low-Ride, Level II Retention™ Holster, for Pistols	40											
	6287	SLS Belt Loop Holster, for Pistols	227											
	6304	ALS®/SLS Tactical Holster, for Pistols	123											
	6304RDS	ALS®/SLS Tactical Holster, for Pistols	129											
	6305	ALS®/SLS Tactical Holster w/ Quick-Release, for Pistols	123											
	6354	ALS® Tactical Holster, for Pistols	130											
	6354DO	ALS® Optic Tactical Holster, for Pistols	136											
	6354RDS	ALS® Tactical Holster, for Pistols	135											
	6355	ALS® Tactical Holster, for Pistols	130											
	6355RDS	ALS® Tactical Holster w/Quick-Release, for Pistols	135											
	6360RDS	ALS®/SLS Mid-Ride, Level II Retention™ Holster, for Pistols	53											
	6362	ALS®/SLS Hi-Ride Level III Retention™ Holster, for Pistols	47											
	6362RDS	ALS®/SLS Hi-Ride, Level II Retention™ Holster, for Pistols	53											
	6365	ALS®/SLS, Low-Ride, Level III Retention™ Holster, for Pistols	47											
	6365RDS	ALS®/SLS Low-Ride, Level II Retention™ Holster, for Pistols	53											
	6367	ALS®/SLS Belt Loop Holster, for Pistols	236											
	6376	ALS® Hi-Ride Belt Slide Holster, for Pistols	242											
	6376	ALS® Hi-Ride Belt Slide Holster, for Revolvers	247											
	6377	ALS® Belt Loop Holster, for Pistols	242											
	6377	ALS® Belt Loop Holster, for Revolvers	247											
	6378	ALS® Paddle and Belt Loop Combo Holster, for Pistols	242											
	6378	ALS® Paddle and Belt Loop Combo Holster, for Revolvers	247											
	6378USN	Als® Low Signature Holster	137											
	6379	ALS® Belt Clip Holster, for Pistols	242											
	6379	ALS® Belt Clip Holster, for Revolvers	247											
	6384	ALS® OMV Tactical Holster, for Pistols	138											
	6384RDS	ALS® OMV Tactical Holster, for Pistols	143											
	6385	ALS® OMV Tactical Holster w/ Quick-Release, for Pistols	138											
	6385RDS	ALS® OMV Tactical Holster w/Quick-Release, for Pistols	143											
	6390	ALS®, Mid-Ride, Level I Retention™ Holster, for Pistols	41											
	6390RDS	ALS® Mid-Ride, Level II Retention™ Holster, for Pistols	44											
	6392	ALS®/SLS Hi-Ride Level I Retention™ Holster, for Pistols	41											
	6392RDS	ALS® Hi-Ride, Level II Retention™ Holster, for Pistols	46											
	6395	ALS®, Low-Ride, Level I Retention™ Holster, for Pistols	41											
	6395RDS	ALS® Low-Ride, Level II Retention™ Holster, for Pistols	46											
	6520	SLS EDW Clip-On Style, Level II Retention™ Holster	55											
		SLS/ALS® Accessories	70											
		Belt Loop Accessories for 3-Hole Pattern Holsters	70											
	7004	7TS™ SLS Tactical Holster, for Pistols	145											
	7005	7TS™ SLS Tactical Holster w/Quick-Release, for Pistols	145											
	7280	7TS™ SLS Mid-Ride Level II Retention™ Holster, for Pistols	56											
	7280/7360/7390	CAS™ - Camera Activation System	69											
	7282	7TS™ SLS Hi-Ride Level II Retention™ Holster, for Pistols	56											
	7285	7TS™ SLS Low-Ride Level II Retention™ Holster, for Pistols	56											
	7304	7TS™ ALS® Tactical Holster, for Pistols	149											
	7305	7TS™ ALS® Tactical Holster w/ Quick-Release, for Pistols	149											
	7352	Badge Holder w/ Neck Chain	103											
	7354	7TS™ ALS® Tactical Holster	153											
	7355	7TS™ ALS® Tactical Holster w/ Quick-Release	153											
	7360	7TS™ ALS®/SLS Mid-Ride Level III Retention™ Holster, for Pistols	60											
	7362	7TS™ ALS®/SLS Hi-Ride Level III Retention™ Holster, for Pistols	60											
	7365	7TS™ ALS®/SLS Low-Ride Level III Retention™ Holster, for Pistols	60											
	7367	7TS™ ALS®/SLS Concealment Belt Slide Holster, for Pistols	251											
	7376	7TS™ ALS® Hi-Ride Belt Slide Holster, for Pistols	254											
	7377	7TS™ ALS® Concealment Belt Slide Holster, for Pistols	254											
	7378	7TS™ ALS® Concealment Paddle and Belt Loop Holster Combo, for Pistols	254											
	7379	7TS™ ALS® Concealment Belt Slide Holster, for Pistols	254											
	7384	7TS™ ALS® Tactical Holster, for Pistols	157											
	7385	7TS™ ALS® Tactical Holster w/ Quick-Release, for Pistols	157											
	7390	7TS™ ALS® Level I Retention™ Mid-Ride Duty Holster, for Pistols	64											
	7392	7TS™ ALS® Hi-Ride Level I Retention™ Holster, for Pistols	64											
	7395	7TS™ ALS® Low-Ride Level I Retention™ Holster, for Pistols	64											
	7350-01	Badge Holder, Clip-On	102											
	7350-03	Badge Holder, Clip-On	102											
	7350-04	Badge Holder, Clip-On	103											
	7520	EDW/7TS™ SLS Clip-On Style, Level II Retention™	68											
	BAN-200-3	SAFARILAND Banner 3'x2'	294											
	BAN-200-9	SAFARILAND Banner 9'x3'	294											
		Belt Loop Accessories for 3-Hole Pattern Holsters	70											
	CD-2	CD-2 Speedloader Holder, up to 2" (50mm) Belt Clip	188											
	CD-Auto	Clip-On Magazine Holder	257											
	COMP I	COMP I Speedloader	187											
	COMP II	COMP II Speedloader	187											
	COMP III	COMP III Speedloader	187											
	ELS 34	Equipment Locking Fork	183											
	ELS 35	Equipment Receiver Plate	183											
	ELS-KIT	Equipment Locking Kit	185											
	HK-10	Handcuff Key	76											
	HK-10-12	Handcuff Key Display, One Dozen Keys	76											
	HK-10-144	Handcuff Key Display, 12 Dozen Keys	76											
	HK-11	Belt Keeper, Hide a Keyper™	75											
	HRA	High Ride Adaptor	71											
	In-Store	Support Items	294											
	J-KTR	Loading Block	281											
	J-LP	Loading Block	281											
	L820	Leather Plainclothes Belt, 1.25" (32mm)	274											
	L830	Leather Plainclothes Belt, 1.5" (38mm)	274											
	LGT-1	RLS™ Light Only	190											
	MLS 16	MOLLE Accessory Locking Fork	184											
	MPA	Mounting Pattern Adaptor	165											
	P-2200	Duty Holster Belt Loop Insert Adapter	182											
	P-2201	Duty Holster UBL Insert Adapter	182											
	QLS 19	Quick Locking Fork	184											
	QLS 22	Quick Receiver Plate	185											
	QLS 22L	Quick Receiver Plate	185											
	QUICK-KIT1	Quick Locking System Kit	186											
	QUICK-KIT2	Quick Locking System Kit	186											
	QUICK-KIT3	Quick Locking System Kit	186											