

[Fabric Replacement Top](#) for Suzuki® Samurai®

Black Denim - 53701.15

White Denim - 53701.52

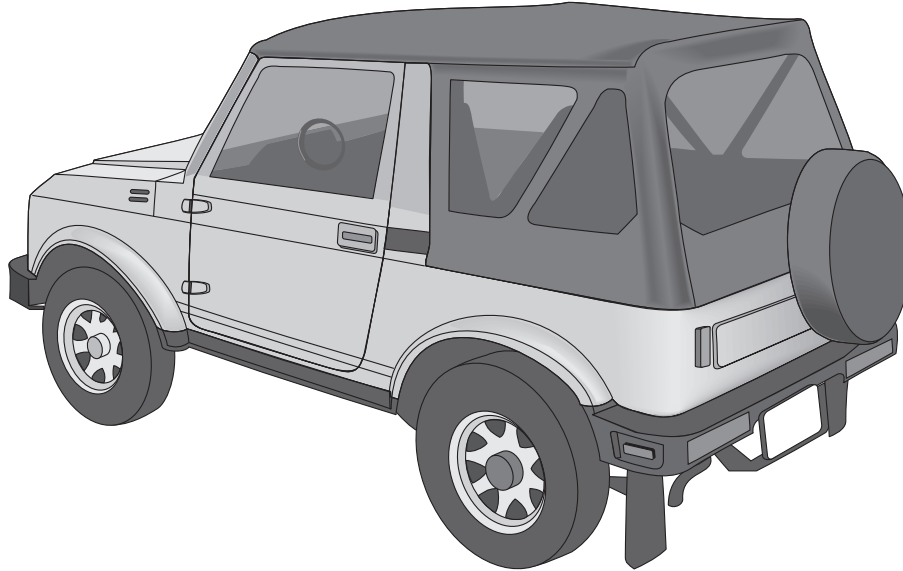

Installation Tips: Before you begin installing this top assembly, read all instructions thoroughly. For ease of installation, the top should be installed at temperatures above 72° F. Below this temperature, the top may contract an inch or more, making it difficult to fit to the vehicle. It is normal for a top to contract and wrinkle when stored in the shipping carton and there may be indentations in the windows. Within a few days of exposure to sunlight, after the installation, the top will relax and the wrinkles will disappear.

ATTENTION ROOF RACK OWNERS: The soft top manufacturer's tests indicate that this soft top can be damaged to the point of failure when used with various roof rack designs. If this replacement soft top is installed on a Samurai vehicle in conjunction with any form of roof rack product, the warranty is null and void.

Necessary Tools:

- Phillips Screwdriver
- Power Drill
- 3/32" and 7/32" Drill Bits
- Pencil
- Center Punch
- Hammer

WARNING: This top is intended to enhance the look of the vehicle and to shield the passengers from normal weather conditions. Do not rely, in any way, on the components of this top to contain occupants within the vehicle, or to protect against injury or death in the event of an accident. This top will not protect the passengers from falling objects. Never operate vehicle in excess of manufacturer's specifications. Read and follow, precisely, all installation instructions provided when installing this top. Failure to do so may result in a poor fitting top and could place occupants of the vehicle in a potentially dangerous situation. Remember to wear your seatbelt at all times.

Step One: Align the top with the two snaps at the front of the vehicle. Drape the top over the vehicle. Open the hook & loop flaps over the door and snap the front snaps into place. Center the plastic strip and slip only the plastic part into the channel at the top of the windshield.

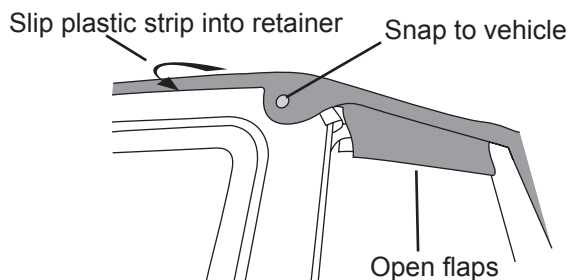

Step Two: Lay the top over the rear bow. Slide the front edges of the side panels into the channel on the rear of the sport bar.

Slide front edge of the side panel into the channel

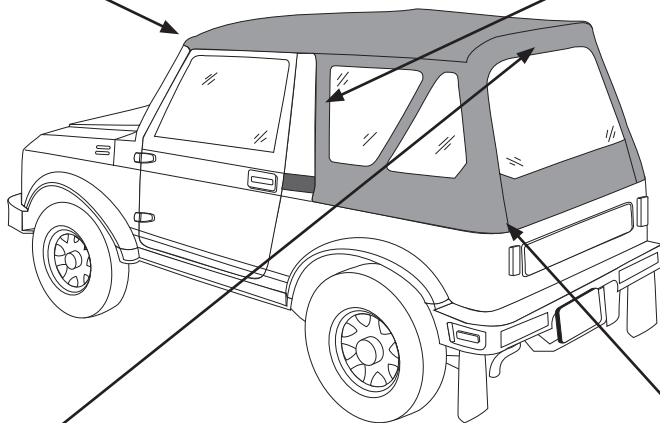
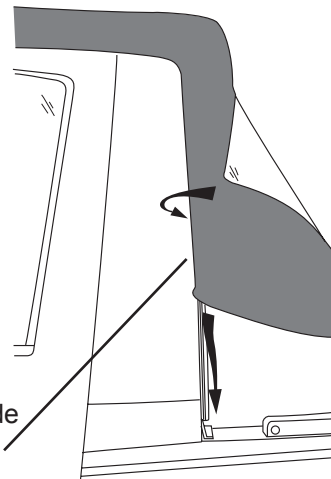

Rear bow

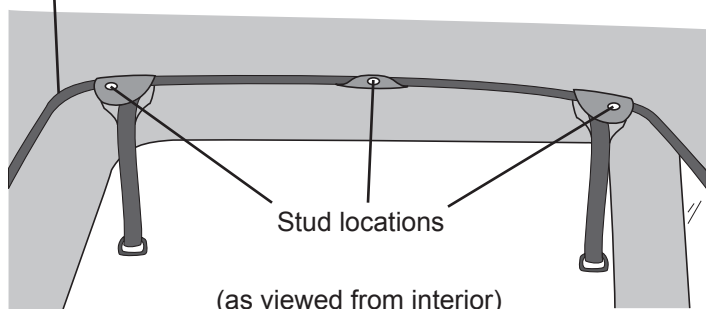

Step Three (Optional): If the Studs are missing from the top bow, install Body Studs (not included). Center the rear seam on the bow and use the snap flap as a guide for marking the location of each snap. Center punch and drill a 3/32" hole for each stud. Install the studs with a sheet metal screw.

Tailgate

Tension Strap

Center punch and drill a 7/32" hole

Use a Phillips head screw and a lock nut

(as viewed from overhead interior, rear corner)

Step Four (Optional): If the Tension Straps are missing from the vehicle, install the included Tension Straps. Center punch and drill a 7/32" hole in each side of the tailgate above the existing bolt. Install each Tension Strap with a Phillips head screw and a lock nut. Install the Tension Strap with the hook & loop fasteners facing the outside of the vehicle.

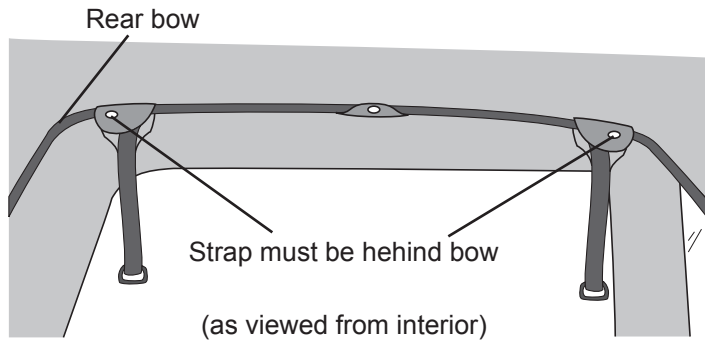

Step Five: Make sure that the straps sewn into the rear of the top are behind the rear bow.

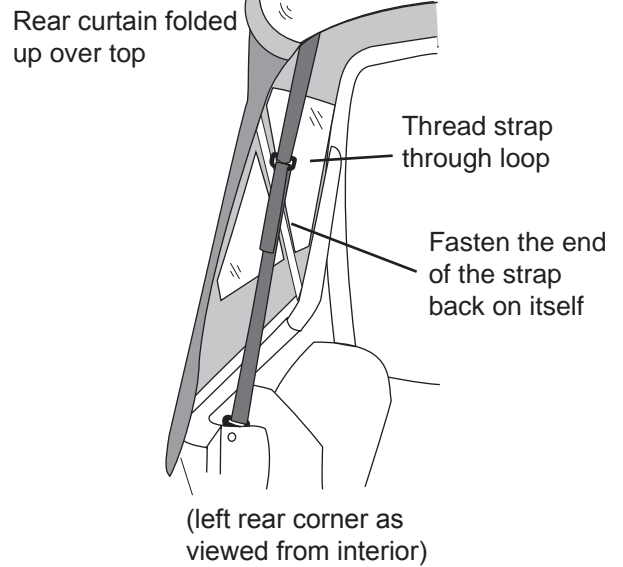
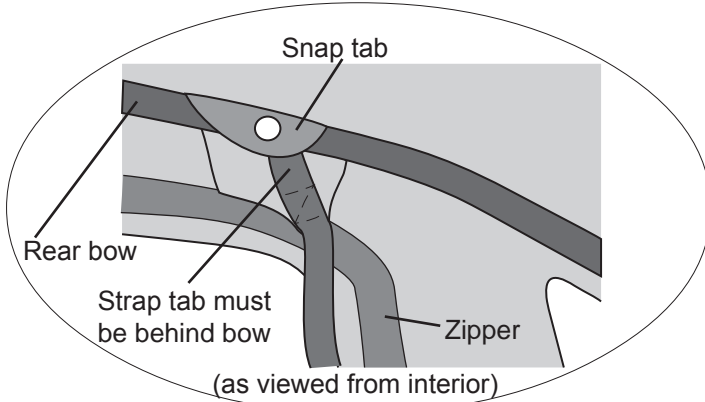

Step Six: Thread the Tension Straps through the loop on the strap sewn into the rear of the top. Pull the strap tight and secure it in place with the hook & loop sewn to the strap. **NOTE:** Pull the strap down tight but do not use excessive force, it is not designed to pull the bow assembly downward.

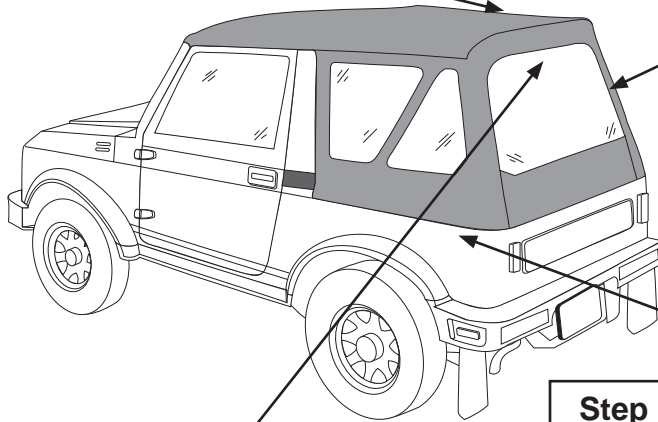

Step Eight: Snap the snaps on the bottom of the side panels from front to back.

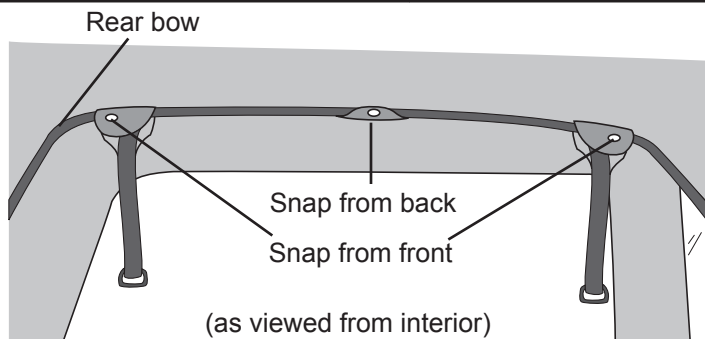

Step Seven: Snap the top to the rear bow. The center snap flap will wrap around the bow from behind and the two outer snap flaps will wrap around the bow from the front.

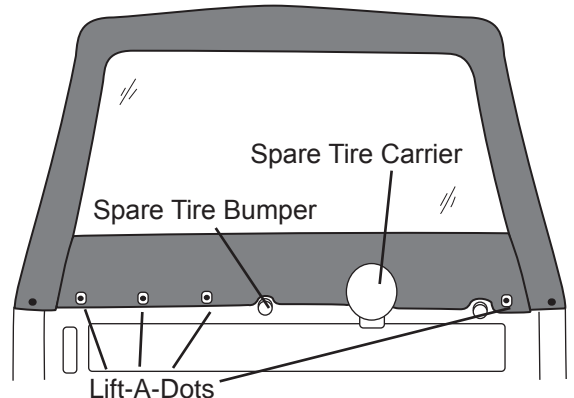

Step Nine: Fasten the bottom of the Rear Curtain to the Lift-A-Dots on the rear of the vehicle.

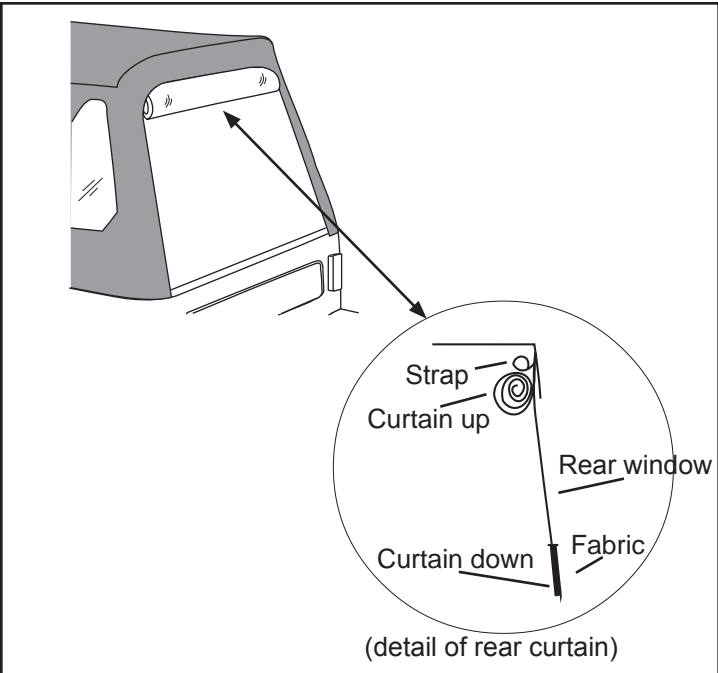
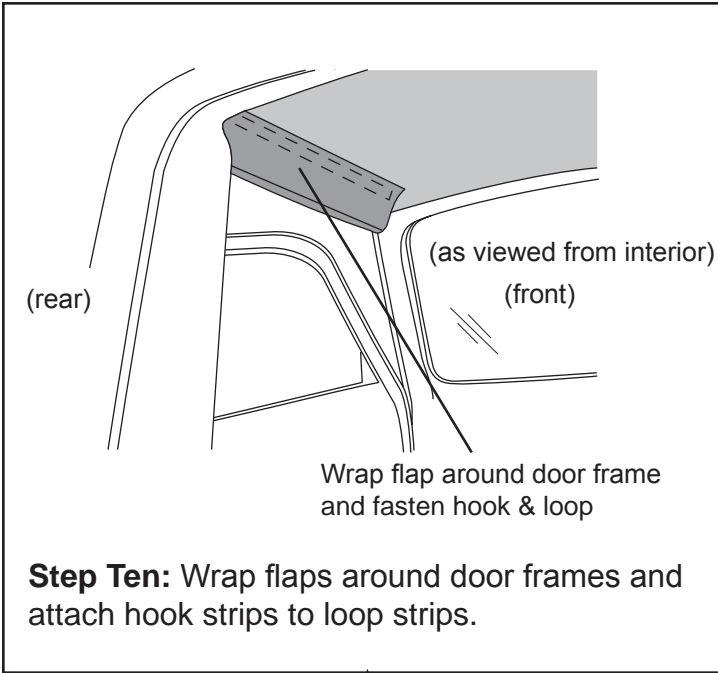

Rear Window: To roll up the Rear Curtain, start at the bottom and roll it upward toward the inside of the vehicle. Avoid wrinkles in the fabric and window. Secure the window in place with the curtain straps inside of the top.

WARNING: When operating the vehicle with the rear window open, at least one or more door windows must be open for proper ventilation.

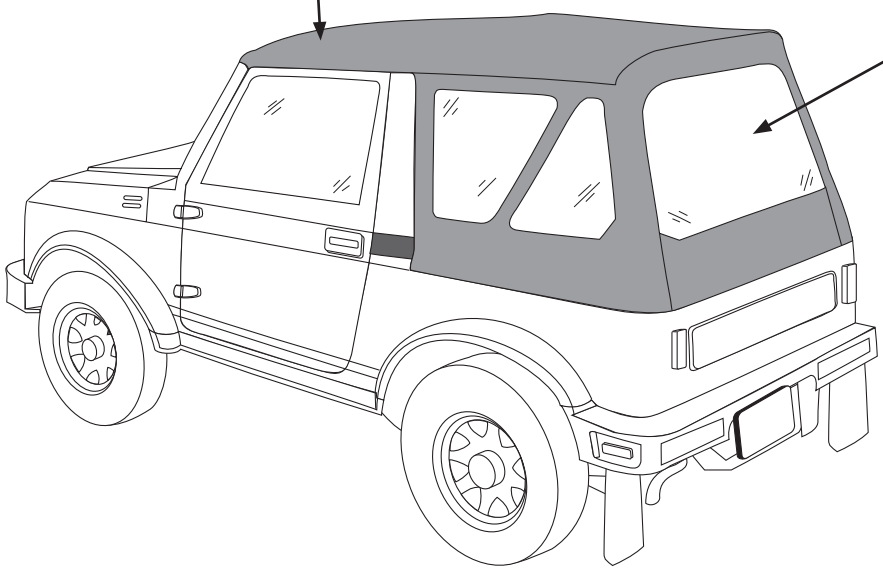

Care and Maintenance of Your New Top.

Your top is made of the finest materials available. To keep it looking new and for the maximum possible wear, it will need periodic cleaning and maintenance.

Washing:

The fabric should be washed often using soap, warm water and a soft bristle brush. Rinse with clear water to remove all traces of soap.

Zippers:

Keeping the zipper cleaned and lubricated with a silicone lubricant will help prevent damage and keep the zippers in a smooth working condition. If a zipper opens behind the slider, the slider may have been spread apart. This problem can usually be repaired by using an ordinary pair of pliers to bring the sides back into parallel. Return slider to end of the zipper in the normal open position. Squeeze lightly at first and test the zipper. If the zipper continues to remain open, squeeze more firmly with the pliers and try the zipper again. Repeat this procedure until the zipper operates correctly.

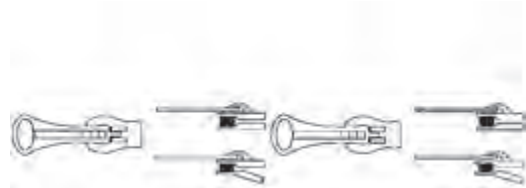

Water:

In the event of seeping through the seams, 3M Scotchgard® may be applied on the inside of the seams to stop the seepage. Rips in the fabric may be repaired with Bondex® iron on patches. Iron the patches to the inside of the top, carefully following the Bondex® instructions.

Snaps:

Keep snaps cleaned and lubricated with silicone to help prevent snaps from sticking to the studs. If a snap does become stuck to a stud, use a small flat head screw driver and GENTLY pry apart to prevent permanent damage to the snap or the top fabric.

Windows:

Keep windows clean to avoid scratching. DO NOT use a brush on the windows! Wash with a water soaked cloth or sponge and a mild dish washing detergent. NEVER WIPE THE WINDOWS WHEN THEY ARE DRY! Be careful when cleaning snow or frost from the vinyl WINDOWS WHEN THEY ARE DRY! Be careful when cleaning snow or frost from the vinyl windows since they are easily scratched and may crack at low temperatures. DO NOT roll the sides or rear window in cold weather. The windows become stiff and will crack.