

## 1976-2006 Jeep CJ, Wrangler XHD Tow Hitch

Contents:	Quantity:
1. Tow Hitch	1
2. Backing Plate	2
3. M12 x 45 HHCS	8
4. M12 Washers	8
5. M12 Lock Washers	8

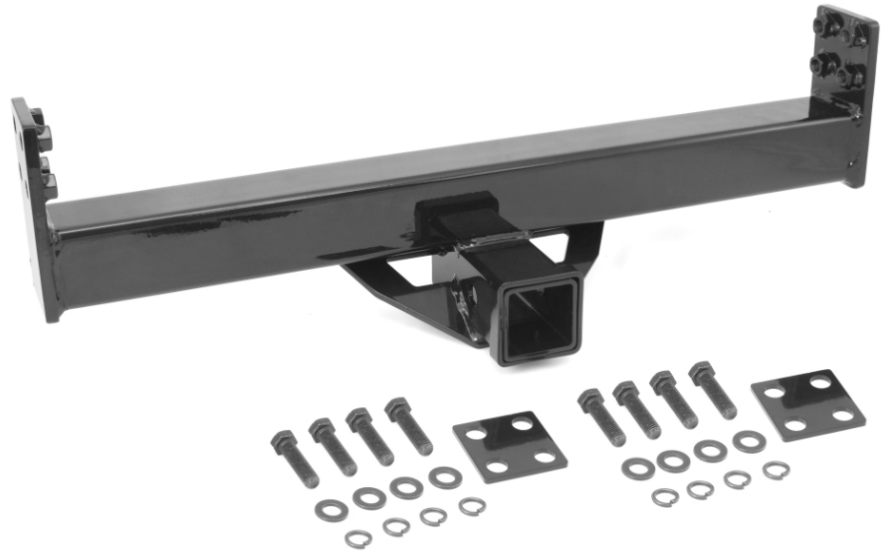

Notice: This tow hitch must only be used with the Rugged Ridge 1976-2006 XHD Bumper, part number 11546.10.

Notice: This hitch is designed for light duty towing (2,000 towing weight, 200lb tongue weight capacity). Always follow manufacturers recommended towing specifications when towing or using any tow hitch accessories.

1. Supporting the tow hitch from below, raise the tow hitch up (Figure 1) between the two sub-frames and slot the hitch in the pre-cut opening in the bumper.
2. It is necessary to temporarily locate and secure the tow hitch in order to ease the installation of backing plates. While supporting the tow hitch thread a supplied M12 bolt through the top right corner of the sub-frame and into the corresponding welded nut of the tow hitch (Figure 2).
3. Repeat on the other side of the tow hitch.

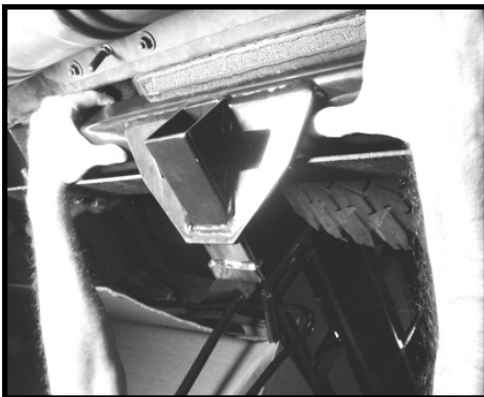

Figure 1.



Figure 2.

4. The backing plates do not have uniform hole placement and vertical orientation needs to be determined. Refer to Figure 3 for the proper orientation of the backing plate.
5. Once vertical orientation is determined, insert bolt and washer assembly (Figure 4) through the bottom right corner of the backing plate (Figure 5).
6. Thread the bolt and washer assembly into the tow hitch. Do not tighten the bolt at this time.
7. Repeat on the other side of the vehicle.

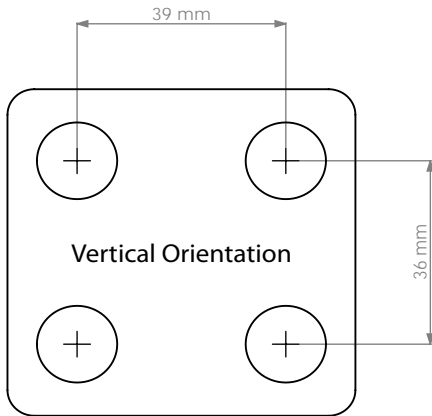

Figure 3.

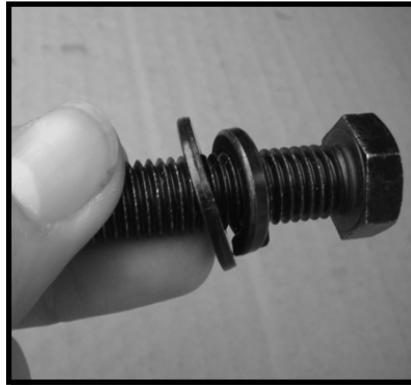

Figure 4.

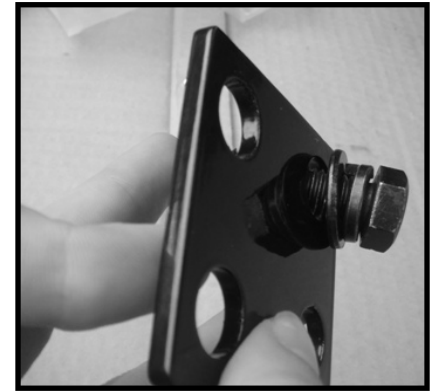

Figure 5.

8. Remove the bolt that was installed in step 2. Rotate the backing plate so all of the holes line up with the holes in the sub-frame. Thread another bolt and washer assembly into the top right corner of the backing plate and sub-frame into the tow hitch (Figure 6).
9. Install 2 more bolt and washer assemblies through the backing plate, sub-frame, and into the tow hitch (Figure 7). Do not tighten the bolts at this time.
10. Repeat the above steps on the other side of the vehicle.

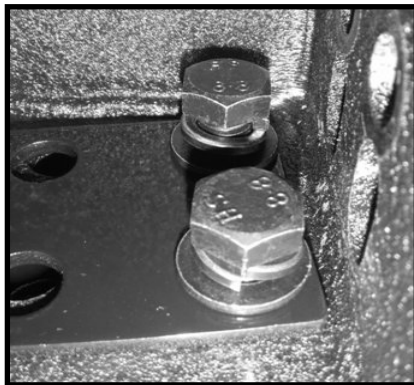

Figure 6.



Figure 7.

11. Once all eight bolt and washer assemblies have been loosley installed, make sure the hitch is centered in the bumper cutout (Figure 8).
12. Using an 18mm socket with an extenssion (or a deep well socket), tighten the driver side bolts approxiamtely half way down. Move to the other side of the vehicle and tighten the bolts approximately the same amount as the driver side. If equipped with the optional Rugged Ridge 1976-2006 XHD Tire Carrier, part number 11546.42, it may be necessary to loosen the tire carrier mounting bolts in the top of the bumper in order to access the bolts located at the top of the sub-frames.
13. Repeat step 12 until the bolts are all tightened down.

Note: The gradual side to side tightening is done in order to keep the tow box of the tow hitch centered in the bumper cutout.

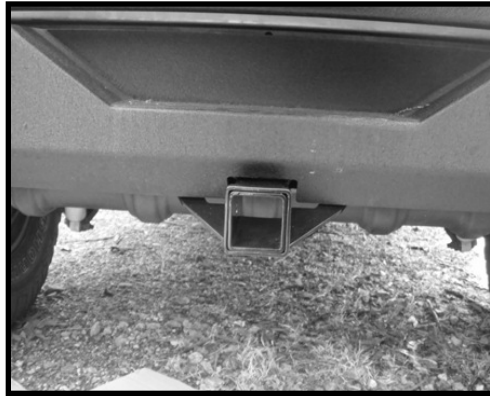

Figure 8.

This completes the installation of the 1976-2006 Jeep CJ, Wrangler XHD Tow Hitch.

