

ROUGH COUNTRY

SUSPENSION SYSTEMS®



1557BAG16

2015-18 F-150 4"/5"/6" LIFT KIT

THANK YOU FOR CHOOSING ROUGH COUNTRY FOR YOUR SUSPENSION NEEDS.

Rough Country recommends a certified technician install this system. In addition to these instructions, professional knowledge of disassemble/reassembly procedures as well as post installation checks must be known. Attempts to install this system without this knowledge and expertise may jeopardize the integrity and/or operating safety of the vehicle.

Please read instructions before beginning installation. Check the kit hardware against the parts list. Be sure you have all needed parts and know where they go. Also please review tools needed list and make sure you have needed tools.

PRODUCT USE INFORMATION

▲WARNING The taller a vehicle is, the easier it will roll. We strongly recommend, because of rollover possibility that seat belts and shoulder harnesses should be worn at all times. Avoid situations where a side rollover may occur.

▲WARNING Generally, braking performance and capability are decreased when larger/heavier tires and wheels are used. Take this into consideration while driving. Do not add, alter, or fabricate any factory or after-market parts to increase vehicle height over the intended height of the Rough Country product purchased. Mixing component brands is not recommended.

Rough Country makes no claims regarding lifting devices and excludes any and all implied claims. We will not be responsible for any product that is altered. If questions exist we will be happy to answer them concerning the design, function, and correct use of our products.

▲NOTICE The 6" suspension system was developed using a 35X12.50/18 tire with 18 x 9 wheel with 4 1/2" backspace. The lifts were designed to lift the front to level the vehicle. Due to manufacturing, dimension variances, and inflation all tire and wheel combinations should be tested prior to installation on all oversized / wider then stock tires. We recommend a wheel not exceeding 8" in width be used with a minimum backspacing of 4.5" to a maximum of 5". When using a stock wheel, it must be 18" or larger and the maximum tire width is 11 1/2".

▲NOTICE Vehicles will require the EPAS (Electronic Power Assist Steering) plugs to be disconnected prior to beginning installation of this kit. See installation instructions. Failure to disconnect these plugs may result in damage to the EPAS module resulting in an error message being displayed, which will require replacement of the EPAS module

▲NOTICE DEALER AND VEHICLE OWNER

Any vehicle equipped with any Rough Country product should have a "Warning to Driver" decal installed on the inside of the windshield or on the vehicle's dash. The decal should act as a constant reminder for whoever is operating the vehicle of its unique handling characteristics.

Tools Needed:

5mm Allen Wrench	Floor Jack
8mm Allen Wrench	Jack stands
8mm wrench /socket	Reciprocating Saw
10mm wrench /socket	Hammer
12mm Wrench	9/16 wrench /socket
13mm wrench / socket	1 1/16" Wrench
15mm wrench /socket	Drill
16mm wrench /socket	1/4" Drill Bit
18mm wrench /socket	5/8" Drill Bit
19mm wrench /socket	11/32" Drill Bit
21mm wrench /socket	
22mm wrench /socket	
24mm wrench /socket	
30mm wrench /socket	

Torque Specs:

Size	Grade 5	Grade 8
5/16"	15 ft/lbs	20 ft/lbs
3/8"	30 ft/lbs	35 ft/lbs
7/16"	45 ft/lbs	60 ft/lbs
9/16"	95 ft/lbs	130 ft/lbs
	Class 8.8	Class 10.9
10MM	32ft/lbs	45ft/lbs
18MM	170ft/lbs	240ft/lbs



KIT CONTENTS

1557Box1:

1-Driver Side Knuckle

1557Box2:

1-Pass Side Knuckle

1555Box4:

1-Fr Crossmember

1-Rr Crossmember

1557Box15:

2-Dr & Pass Diff Bracket

1-Pass Side Diff Brace Bracket

1-Dr Side Sway Bar Bracket

1-Pass Side Sway Bar Bracket

2-Fr Brake Line Brackets

1-Front Lower Skid Plate

1-Rear E-Brake Bracket

1-Front Driveshaft Spacer

1-Rear Brake Line Bracket

1-1557Bag8

1-1557Bag13

1-1557Bag14

1-1557Bag15

1-Front Pass Diff Bracket

1-Dr Rear Diff Mount

2-Cable Ties

1-1500

1557Box12 or 13 (6"), 1556Box11 (5"), or

1555Box2 or 3 (4"):

2-Rear Blocks

2-Rear Shocks

2-Fr Strut Spacers (Not In Strut Kit)

2-Rear Bump Stop Brackets

1-1263Bag2

1-9/16Bag

4-9/16" x 3" x 13" Ubolts

1-10mmStudBag

1-1556Bag2

23033-4" Struts

23034-6" Struts

1557Bag8 Containing:

For Fr Dr Side Upper Diff Mount:

1-9/16" x 4" Bolt

2-9/16" Flat Washers

1-9/16" Lock Nut

1-1/2" x 1.5" Bolt

1-1/2" Nylock Nut

2-1/2" Flat Washer

1557Bag8 Continued:

For Fr Dr Side Lower Diff Mount:

1-9/16" x 4" bolt

2-9/16" Flat Washers

1-9/16" Lock Nut

For Fr / Rr Crossmember:

2-18mm x 150mm Bolts

4-3/4" Flat Washers

2-18mm Lock Nuts

For Fr Pass Side Diff Mount:

1-9/16" x 4" Bolt

2-9/16" Flat Washers

1-9/16" Lock Nut

1500 Containing:

For Lower Control Arms:

4-18mm x 160mm Cam Bolts

4-Flat Washers

4-18mm Lock Nuts

1557Bag15 Containing:

For Pass Diff Brace:

2-12mm x 35mm

2-12mm Lock Nut

4-Flat Washers

1557Bag13 Containing:

For Front Skid Plate:

4-3/8" x 1" Bolt

4-3/8" Flat Washers

2-3/8" Nylock Nuts

For Front Driveshaft:

6-10mm x 85mm Allen Bolts

For Front Brake Line Bracket:

2-5/16" x 3/4" Bolt

2-5/16" Flat Washer

2-5/16" Lock Nut

For Sway Bar Brackets:

4-7/16" x 1.25" Bolts

8-7/16" Flat Washers

4-Lock Nuts

For Diff Tube:

1-Diff Tube Ext.

1-Tube Coupler

1557Bag13 Coninued:

For Rear Brake Line Brkt:

1-3/8" x 1" Bolt

2-3/8" Flat Washers

1-3/8" Lock Nut

For Rear E-brake Bracket:

1-5/16" x 3/4" Bolt

2-5/16" Flat Washers

1-5/16" Lock Nut

10mmStudBag Containing:

For Front Strut Spacers:

6-10mm Studs

6-10mm Lock Washer

7-10mm Hex Nuts

1-1/2" Jam Nut

6-3/8" Flat Washers

9/16Bag:

For Rear Blocks:

8-9/16" Nuts

8-9/16" Flat Washers

1263Bag2:

For Rear Blocks:

4-7/16" UBolts

8-7/16" Nylock Nuts

8-7/16" Flat Washers

1556Bag2:

For Rear Blocks:

2-3/8" UBolts

4-3/8" Nylock Nuts

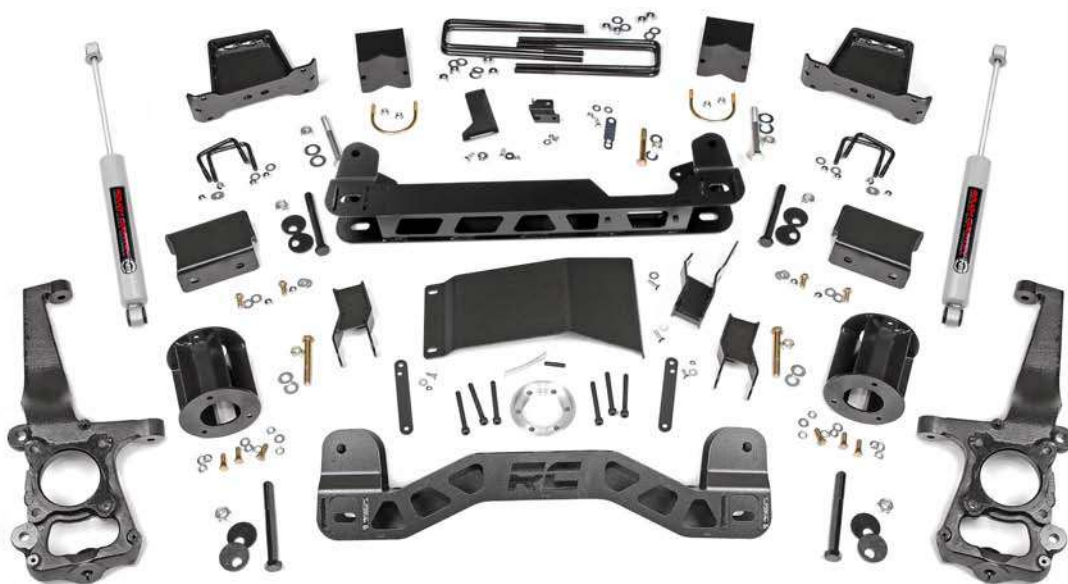

6" Kit Shown in Picture



INSTALLATION INSTRUCTIONS

1. Chock the rear wheels and jack up the front of the vehicle.
2. Place jack stands under the frame rails and lower onto jack stands.
3. Remove the wheels/tires using a 21mm socket.
4. Remove the skid plate with a 13mm socket. **See Photo 1.**
5. Remove the EPAS (Electronic Power Assist Steering) Plugs as shown located on the steering assembly by the front differential. **See Photo 2. This must be done BEFORE installation is started.**



PHOTO 1



PHOTO 2

6. Remove tie-rod end using a 21mm wrench. Using the appropriate tool remove the tie-rod from the knuckle. **Photo 3.**
7. Remove the ABS and brake line bracket from the knuckle using a 8mm wrench for the ABS wire and a 10mm wrench for the brake line bracket. Retain hardware for reuse. **See Photo 4.**



PHOTO 3

TAP TO LOOSEN THE TIE ROD

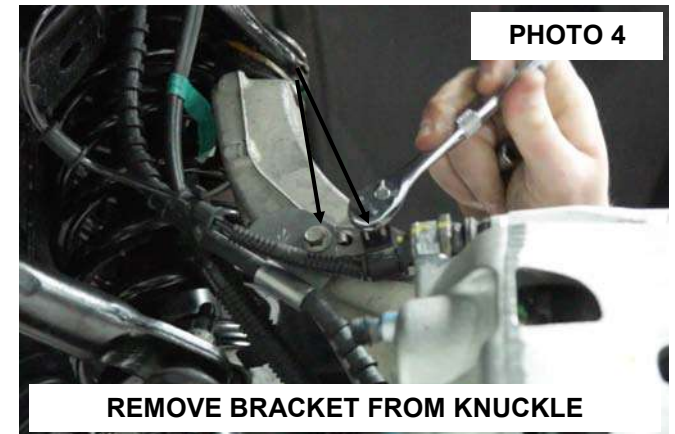

PHOTO 4

REMOVE BRACKET FROM KNUCKLE

8. Remove the vacuum line from the hub. **See Photo 5.**
9. Using a 19mm socket or 21mm socket, remove brake caliper as shown in **Photo 6.** Hang caliper out of way. Do not let caliper hang by brake hose as this will damage hose. Retain hardware for reuse. Remove rotor.



PHOTO 5

REMOVE VACUUM LINE FROM HUB

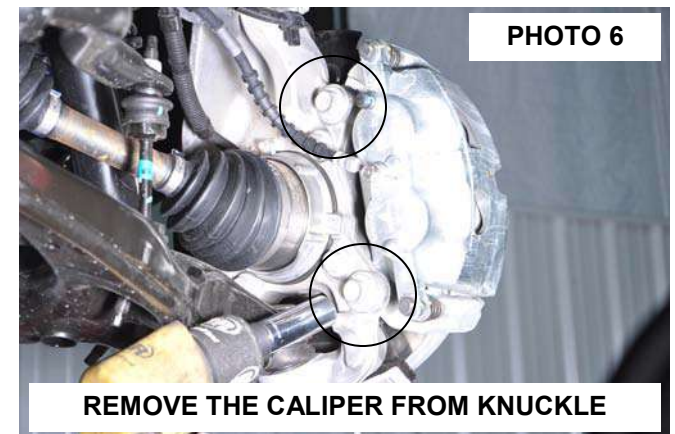
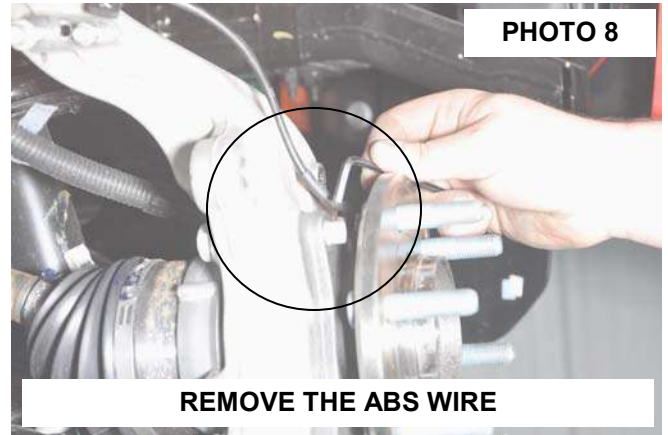
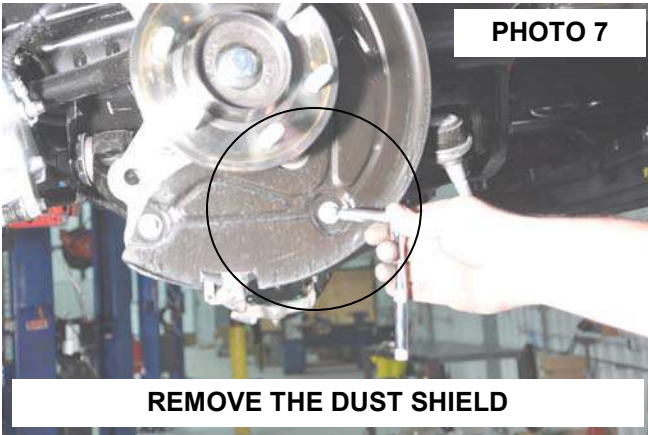

PHOTO 6

REMOVE THE CALIPER FROM KNUCKLE

10. Remove the dust shield using a 8mm socket and dust cap. **See Photo 7.**

11. Remove the ABS wire from the bearing assembly using a 5mm allen wrench. **See Photo 8.**



12. Remove the axle nut using a 15mm socket. Retain hardware for reuse. **See Photo 9.**

13. Loosen the upper ball joint nut using a 21mm wrench. Use the appropriate tool to release ball joint from knuckle. **See Photo 10.**

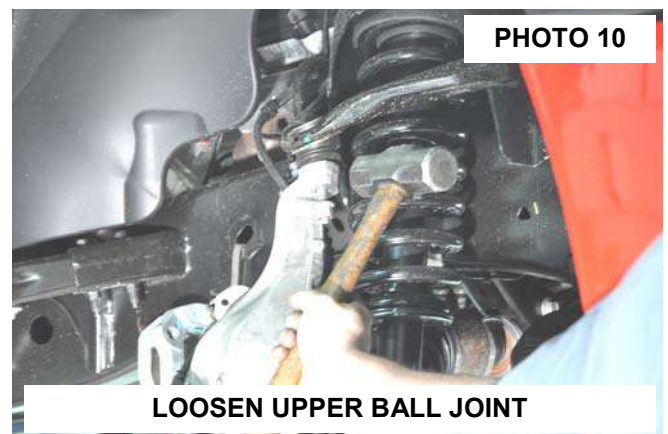

14. Loosen the lower ball joint using a 24mm wrench. Use the appropriate tool to release ball joint from knuckle. **See Photo 11.**

15. Remove the upper and lower ball joint nuts and remove the knuckle from the vehicle.

16. Remove the sway bar links from the sway bar using a 8mm and 19mm wrench. Retain hardware for reuse. **See Photo 12.**

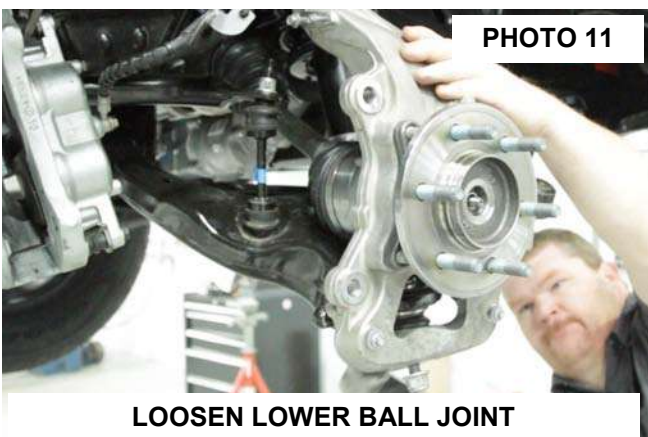

17. Remove the lower strut nuts using a 18mm socket. **See Photo 13.** Retain hardware for reuse.
18. Remove the sway bar from the frame mount using a 15mm socket. *Please note the position that the sway bar is installed from the factory to make sure it is reinstalled correctly.* Retain hardware for reuse. **See Photo 14.**

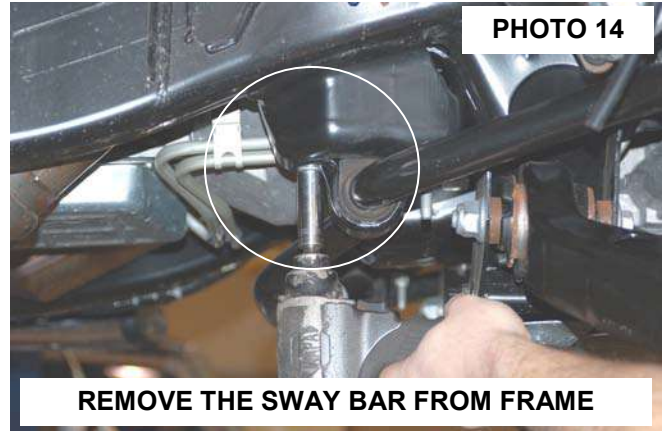
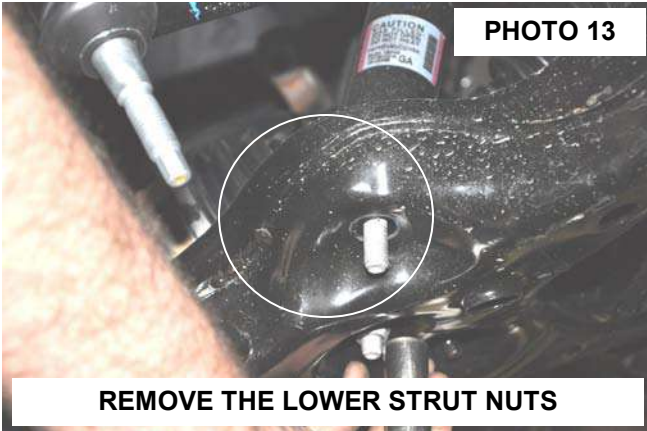

19. Remove the lower control arm using a 21mm and 1-1/16" wrench. Retain hardware for reuse. **See Photo 15.**
20. Remove the strut from the upper mount using a 15mm socket / wrench. Retain hardware for reuse. **See Photo 16.**

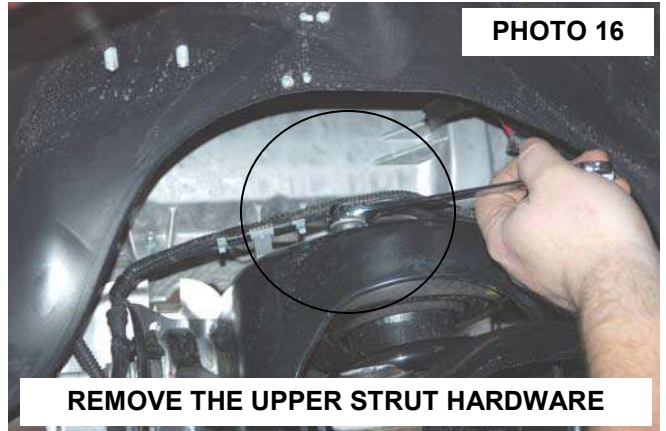
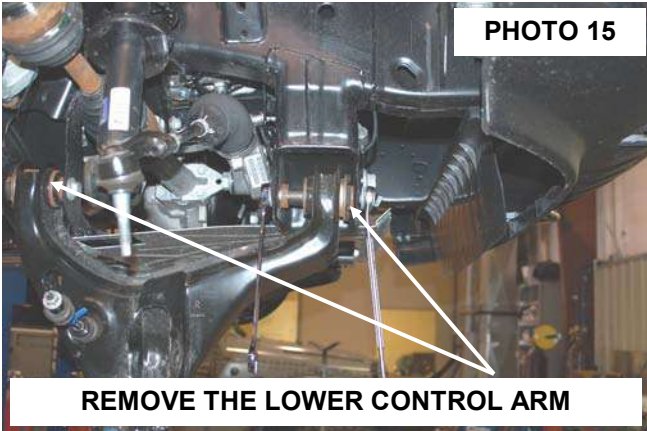

21. Remove the lower skid plate if equipped by removing the 4 bolts using a 13mm socket. **See Photo 17.**
22. Remove the driveshaft from the front differential using a 10mm socket. **See Photo 18.** Secure driveshaft out of the way.

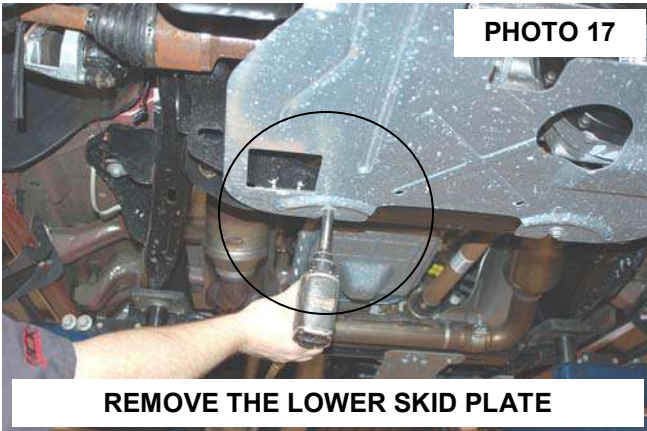

23. Remove the stock rear cross-member using a 15mm & 18mm socket. Retain hardware for reuse. **See Photo 19.**

▲ NOTICE 2018 Models will have to make rear crossmember mount cuts in steps 26-30 before removing the differential.

24. Support the differential using a floor jack and remove the upper driver side differential bolt using a 18mm wrench. Retain hardware for reuse. **See Photo 20.**

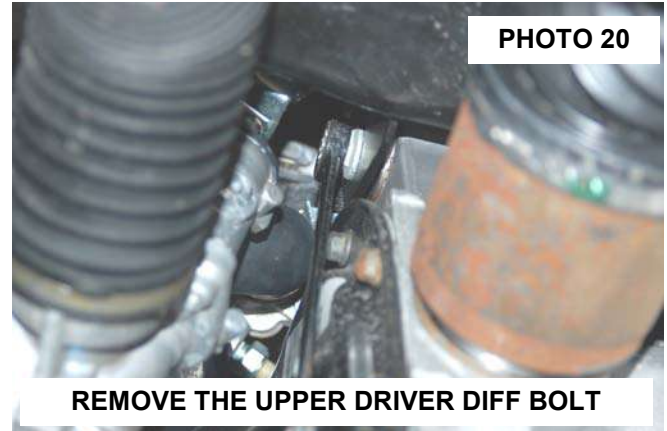
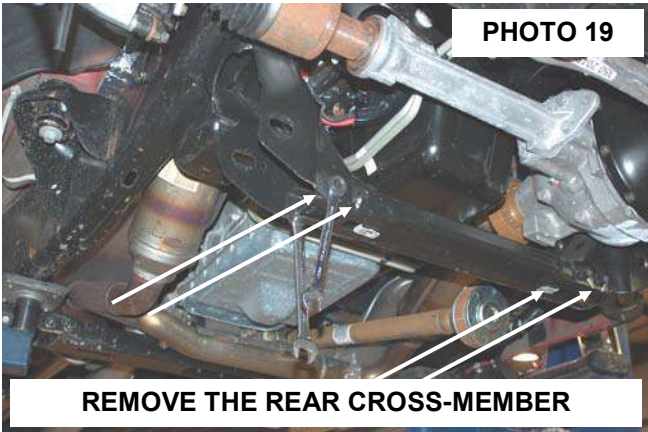

25. Remove the differential vent tube from the differential.

26. Remove the passenger side differential bolt using a 18 & 21mm wrench. Retain hardware for reuse. **See Photo 21.**

27. Remove the lower rear driver side differential bolt using a 21mm socket / wrench. Lower and remove the differential from the vehicle. Tape supplied cutting template on front and back side of the driver side lower cross-member mount. Using template as a guide, trim cross-member mount to allow the differential to be removed. **See Photo 22.**

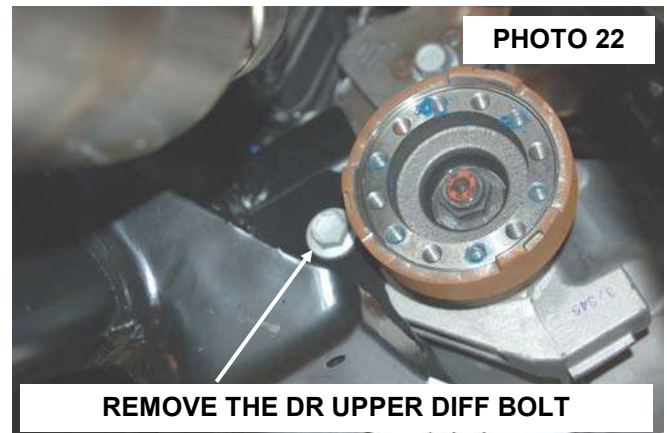
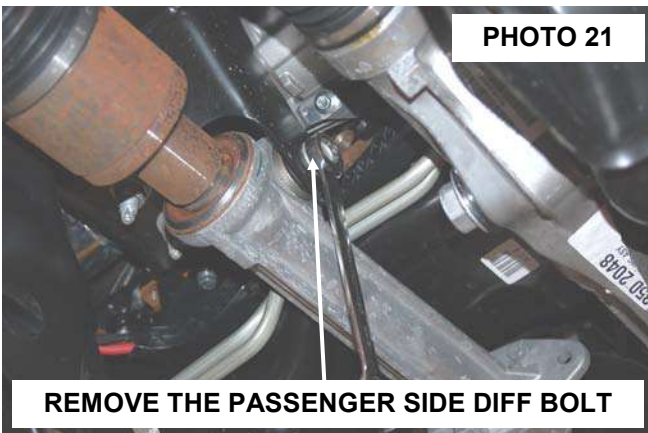

28. Tape supplied cutting template on front and back side of the driver side lower cross-member mount. Using template as a guide, trim cross-member mount to allow the differential to be removed. **See Photo 23.**

29. Complete the trimming of the frame on the driver side using the template. **See Photo 24.**

PHOTO 23



PHOTO 24

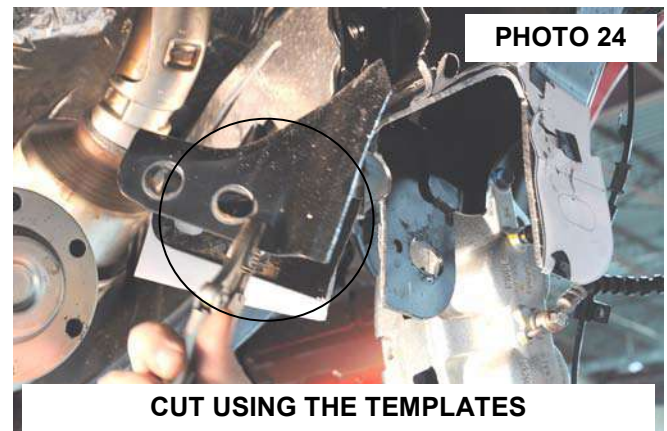

30. Install the new bracket on the passenger side diff mount (**94003787**) with the supplied hardware. Install the 9/16" x 4" bolt, washers & nut in the in the passenger side mount. **See Photo 25.**
31. Install the front driver side diff mount (**94003762C**) with the supplied 9/16" x 4" bolt, washers and nut **from the front to rear**. **NOTE: The differential mounts bolts will need to be inserted from the front of the differential in order to clear the rack and pinion. See Photo 26.**

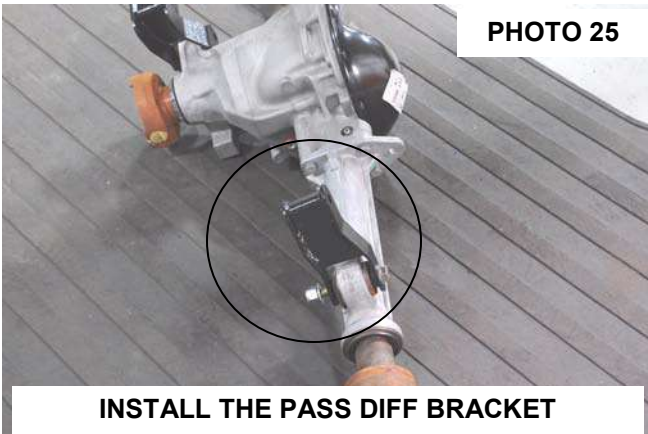

32. Install the rear diff mount using the supplied 9/16" x 4" hardware. **See Photo 27.**
33. Raise the differential into place and install the upper differential bolts using the stock hardware. **See Photo 28.** Do not tighten at this time.

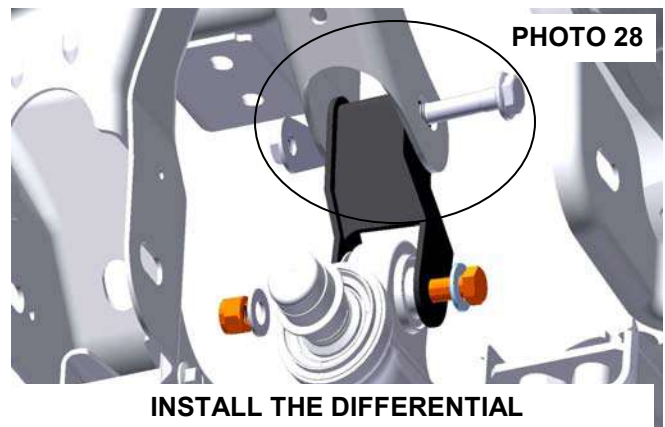

34. Install the sway bar drop brackets using factory hardware. **Do not tighten at this time.**
35. Install the rear cross-member with the supplied 18mm x150mm bolt. The bolt will install through the sway bar bracket and rear cross-member, securing it to the stock location. Do not tighten at this time. **See Photo 29.**
36. Install the passenger side differential brace as shown in **Photo 30** using the supplied 12mm hardware in 1557BAG15. Do not tighten at this time.

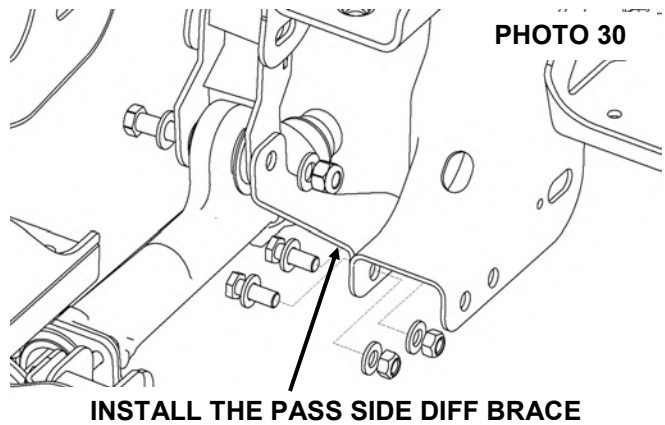
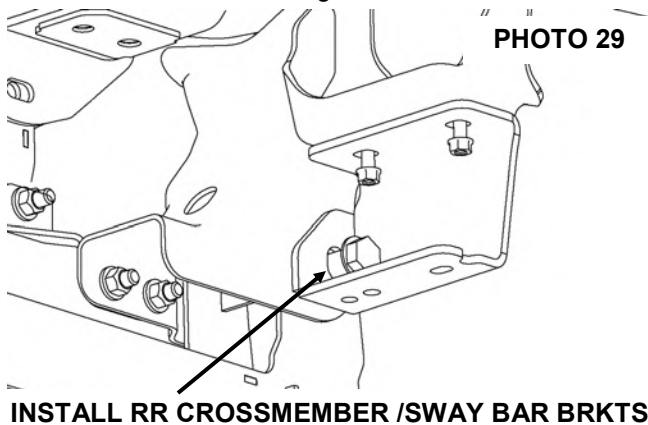

37. Attach the rear diff mount to the cross member using the supplied 1/2" hardware. Attach to upper mount using factory hardware. **See Photo 31.**
38. Tighten the diff bolt with a 21mm and 22mm wrench. **See Photo 32.**

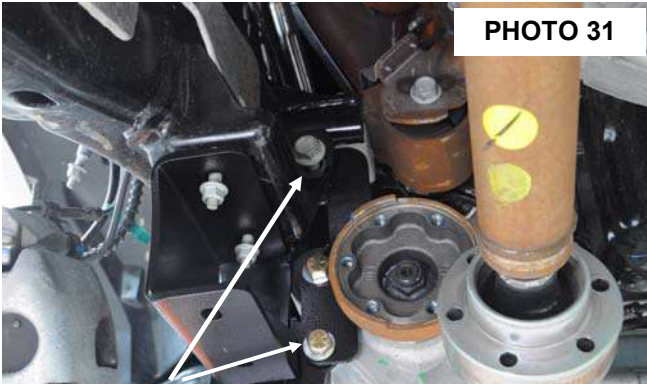

PHOTO 31

INSTALL THE DR SIDE LOWER REAR DIFF BOLT

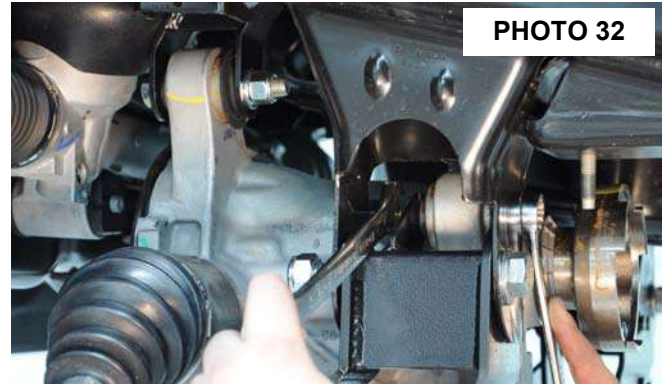

PHOTO 32

TIGHTEN DIFF BOLTS

39. Tighten the sway bar drop mounts to the frame using the factory hardware with a 15mm socket. **See Photo 33.**
40. At this time tighten all diff bolts using 18mm socket / wrench for the upper diff bolts and a 21mm & 22mm socket / wrench for the new supplied lower diff bolts. Also tighten the passenger side diff brace hardware using a 19mm & 18mm socket /wrench.
41. Reinstall the vent tube on the differential with the new supplied vent tube extension 1557BAG13.
42. Install the front cross-member using the factory hardware. **See Photo 34.** Do not tighten at this time.

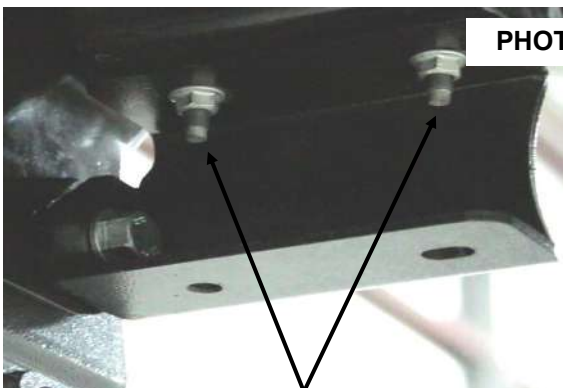

PHOTO 33

TIGHTEN THE SWAY BAR BRACKETS

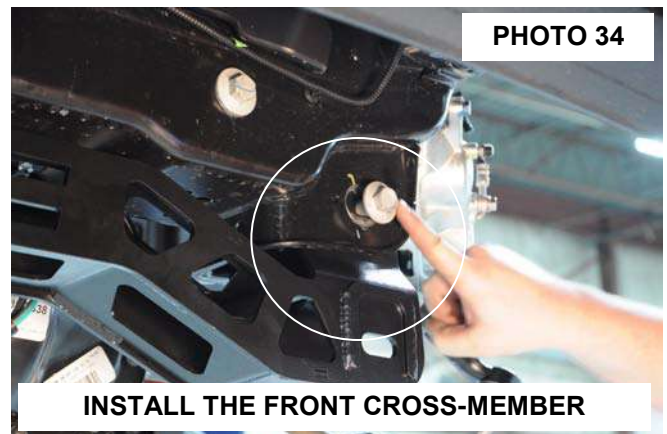

PHOTO 34

INSTALL THE FRONT CROSS-MEMBER

43. Install the lower control arms using the supplied 18mm x 160mm cam bolts, washers and nuts. **See Photo 35.** Do not tighten at this time.
44. Install the new skid plate in the rear cross member threaded holes using the supplied 3/8" x 1" bolts, washers. Attach to the front cross member using the supplied 3/8" x 1" bolts, washers and nylock nuts from 1557BAG6. **See Photo 36.** Tighten using a 9/16" socket and wrench.
45. Tighten all upper cross-member bolts using a 21mm, 1 1/16" socket and 1 1/16" wrench.

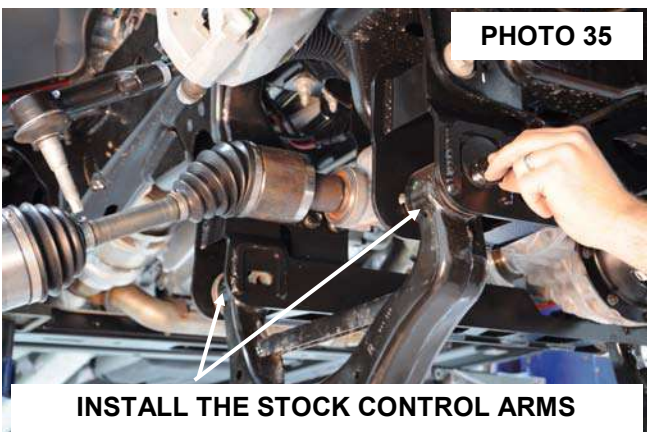

PHOTO 35

INSTALL THE STOCK CONTROL ARMS

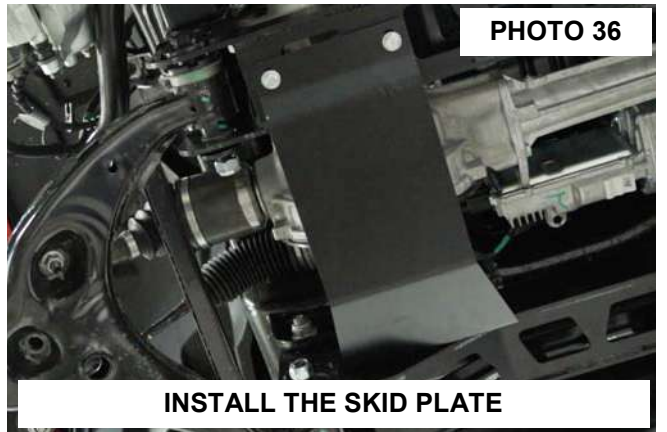

PHOTO 36

INSTALL THE SKID PLATE

46. Install the drive shaft spacer with supplied 10mm x 85mm hardware. **See Photo 37.** Tighten using a 8mm allen wrench.
47. Using a 10mm wrench remove the brake line bracket from the driver and pass side frame. **See Photo 38.**

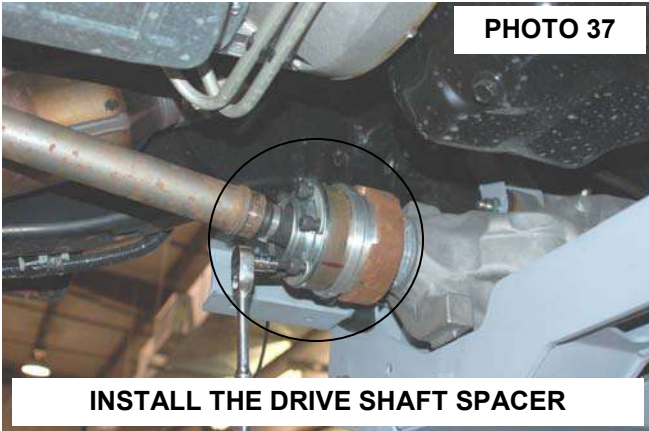

PHOTO 37

INSTALL THE DRIVE SHAFT SPACER

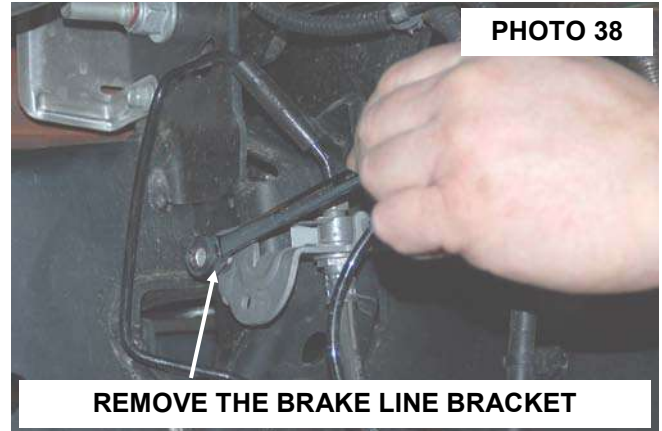

PHOTO 38

REMOVE THE BRAKE LINE BRACKET

48. On the passenger side remove the brake line from the two factory clips. **See Photo 39.**
49. Install the new brake line bracket on the driver and passenger side with the stock hardware. **See Photo 40.**

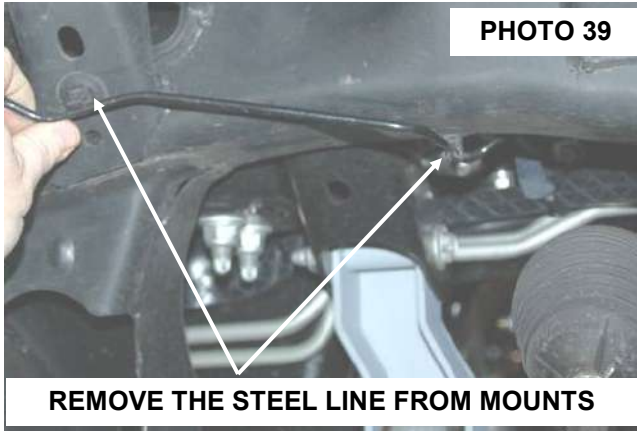

PHOTO 39

REMOVE THE STEEL LINE FROM MOUNTS

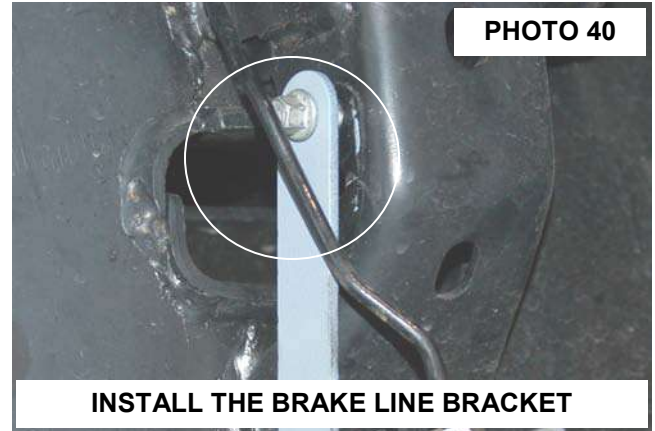

PHOTO 40

INSTALL THE BRAKE LINE BRACKET

50. Install the factory passenger side brake line in the new bracket using the supplied 5/16" x 3/4" bolt, washer and nuts. **Take care to not kink the brake line. See Photo 41.**
51. On the driver side, pull slightly on the brake line to allow the line to be installed on the new bracket. Secure the brake line to the new bracket with the supplied 5/16" x 3/4" bolt, washers and nut. **Take care to not kink the brake line.**
52. Using a 13mm socket / wrench, tighten the supplied brake line hardware and 10mm for the stock hardware.

▲ NOTICE If installing new lifted struts, follow supplied strut instructions and skip to step 56.

52. Install the supplied 10mm studs in the strut spacers with a 17mm wrench, using the 1/2" jam nut as a spacer. **See Photo 42.**

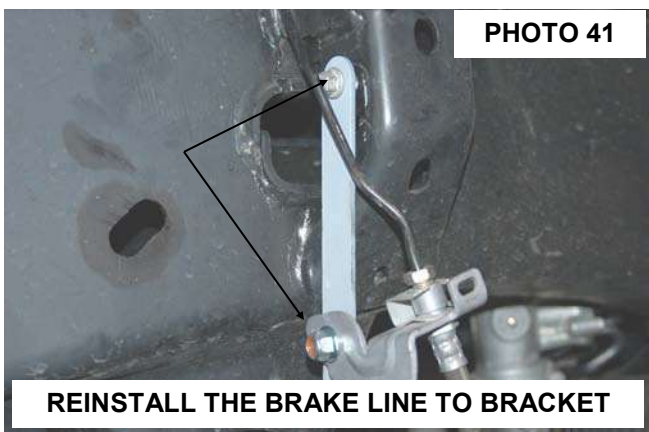

PHOTO 41

REINSTALL THE BRAKE LINE TO BRACKET

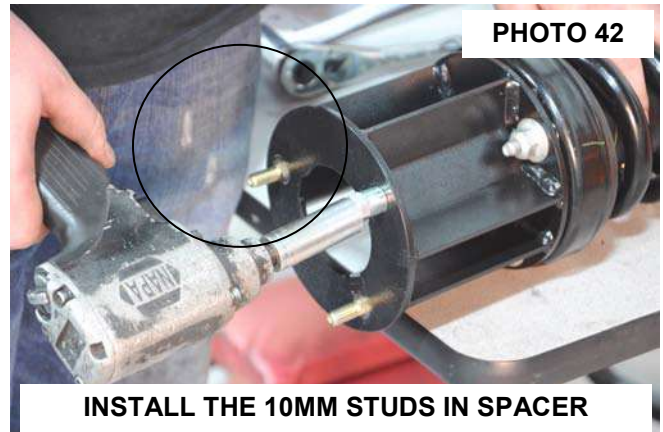

PHOTO 42

INSTALL THE 10MM STUDS IN SPACER

54. Using the stock hardware, install the strut spacers on the struts. Tighten using a 15mm socket. **See Photo 43.**
55. Install the strut with strut spacers installed in the stock upper mount. Secure with supplied 10mm nuts, washers and lock washers. **See Photo 44.** Do not tighten at this time.

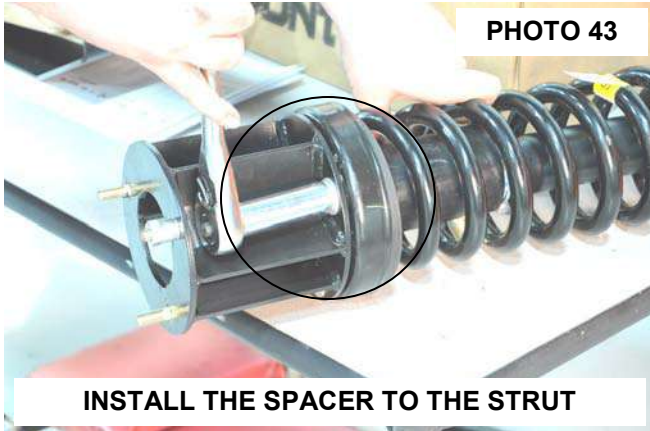

PHOTO 43

INSTALL THE SPACER TO THE STRUT

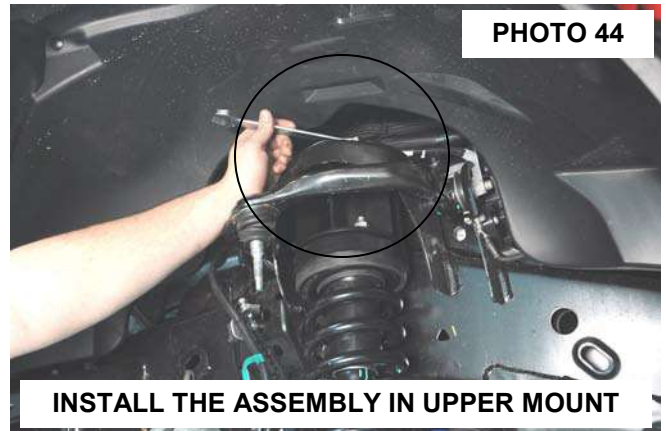

PHOTO 44

INSTALL THE ASSEMBLY IN UPPER MOUNT

56. Install the lower strut in the lower control arm using the factory hardware. Tighten using a 18mm socket.
57. Tighten upper strut mount hardware using 17mm wrench.
58. Install the sway bar body on the sway bar links located on the lower control arms. Install nut to hold the sway bar in place but do not tighten at this time. **See Photo 45.**
59. Swing up the sway bar and install on the sway bar drop brackets using the supplied 7/16" x 1" bolts, washers and nuts. Tighten using a 18mm on the sway bar drop hardware and 18mm wrench on sway bar links on the lower control arms. **See Photo 46.**

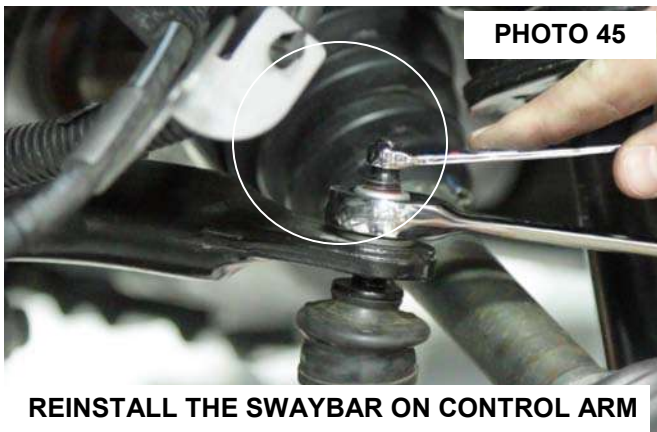

PHOTO 45

REINSTALL THE SWAYBAR ON CONTROL ARM

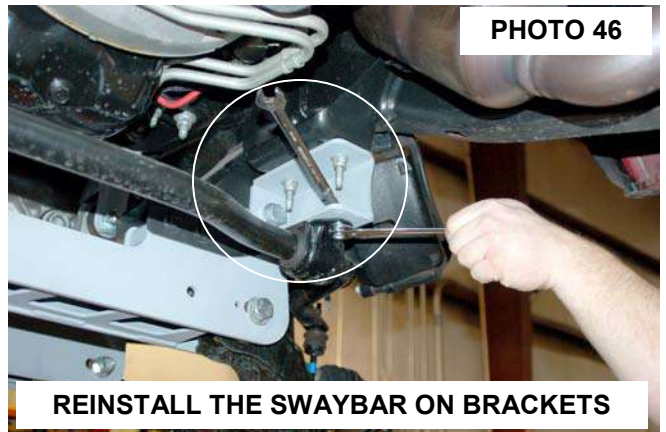

PHOTO 46

REINSTALL THE SWAYBAR ON BRACKETS

60. Remove the stock bearing assembly from the stock knuckle using a 18mm for the bearing and a 8mm for the locking hub mechanism. Install the bearing assembly on the lifted knuckle using the stock hardware. Tighten using a 18mm wrench. **See Photo 47.**
61. Install the new knuckles using the stock hardware on the lower ball joints, tighten using 24mm and a 12mm wrench. **See Photo 48. Do not use air impact on the upper and lower ball joint, tighten with hand tools.**



PHOTO 47

REMOVE BEARING AND HUB

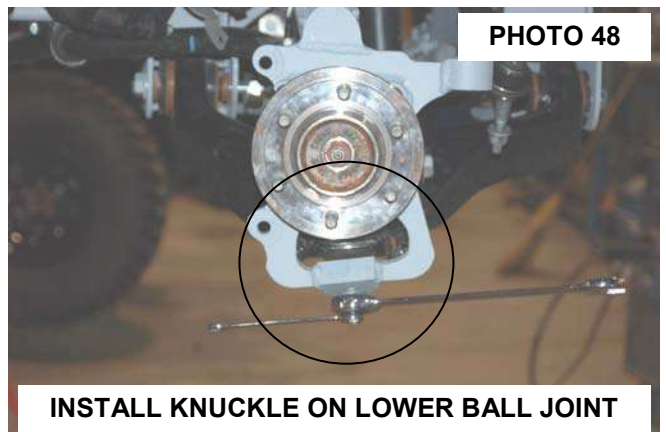

PHOTO 48

INSTALL KNUCKLE ON LOWER BALL JOINT

▲ NOTICE We recommend using OE instructions for disassembly and assembly of IWE actuator, the following instructions are for reference only.

62. Install IWE actuator on CV shaft.

▲ NOTICE Make sure the actuator splines line up to the splines on the CV shaft. See photo 49.

63. Install CV shaft into the knuckle assembly. See Photo 50.



64. Using a floor jack, raise the lower control arm and connect the upper ball joint on the upper control arm to the spindle. Using a 21mm wrench, torque to manufacturer specs. If ball joint turns while tightening, use a 3/8" wrench to hold the ball joint.

65. Reinstall the steering linkage nut using a 21mm wrench.

66. Using a hand vacuum pump, apply and hold 24inHG of vacuum to the actuator through the large port. See Photos 51 and 52.



67. Install the (3) bolts securing the actuator to the knuckle and tighten using an 8mm wrench. **See Photo 53.**

68. **▲ NOTICE** With vacuum still applied to actuator. Measure the depth of the CV shaft treads protruding through the hub bearing. If **minimum 15.5mm or .61"** is not achieved, rotate the hub to eliminate binding of the splines. **See Photo 54.**

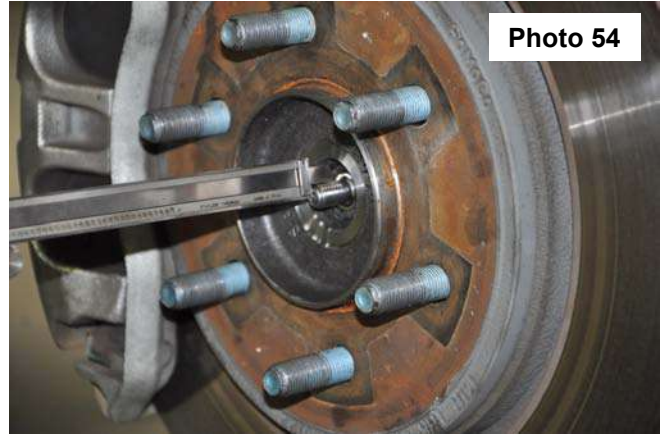

69. Install axle nut and tighten to 30 lb.ft. **▲ NOTICE** Do Not Use an impact, caution must be taken or damage to shaft may occur. **See Photo 55.**



70. Verify free rotation of the hub with **NO** CV shaft rotation. No clicking or grinding noise should be present

71. Release the vacuum from the actuator and rotate the hub to engage the actuator. You may hear/feel the actuator engage.

72. Verify that the hub and CV rotate together. Reconnect the vacuum lines to the actuator. **See Photo 56.**

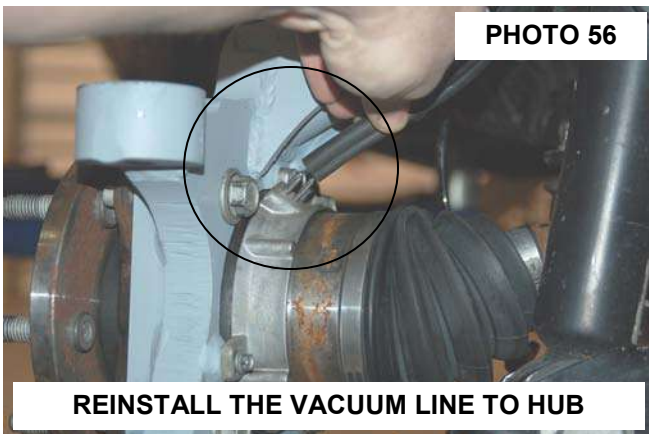

73. Install the ABS wire on the bearing assembly using a 5mm allen wrench. **See Photo 57. NOTE: The factory dust shield will not be reused.**
74. Install the rotor and caliper on the knuckle with the stock hardware using a 19mm or 21mm wrench. Tighten hardware. **See Photo 58.**

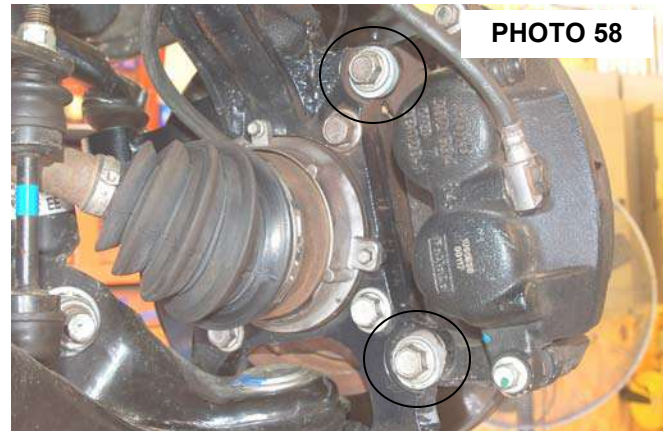
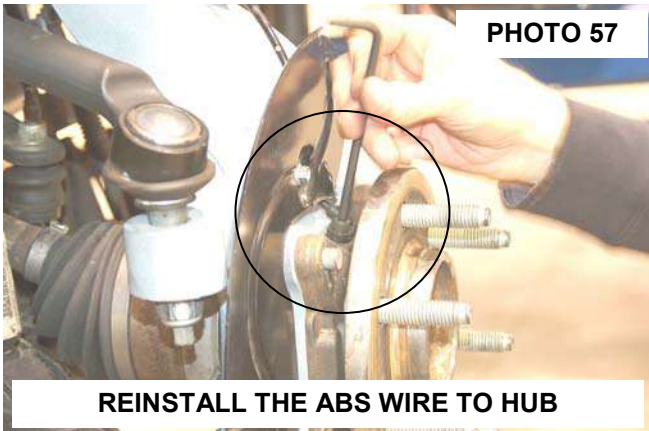

75. Make sure the vacuum hose and ABS wire are out of harms way. Using the supplied zip tie, secure the vacuum hose and ABS wire to the knuckle neck.
76. Install the tires and wheels using a 21mm socket. Remove the jack stands and lower the truck to the ground.
77. Tighten the lower control arm bolts using a 1-1/16" wrench and socket. **Torque to 240 ft/lbs.**

⚠ WARNING Do not cut or remove factory crash bar if equipped.



Front crash bar.



Rear crash bar.

REAR INSTALLATION

1. Chock the front tires and jack the rear the rear end up. Put jack stand under the frame rail and lower truck onto jack stands.
2. Remove tires and wheels using a 21mm socket.
3. Remove rear shocks from the upper and lower mount using 18mm and a 15mm wrench. **See Photo 1 & 2.** Retain the stock hardware.

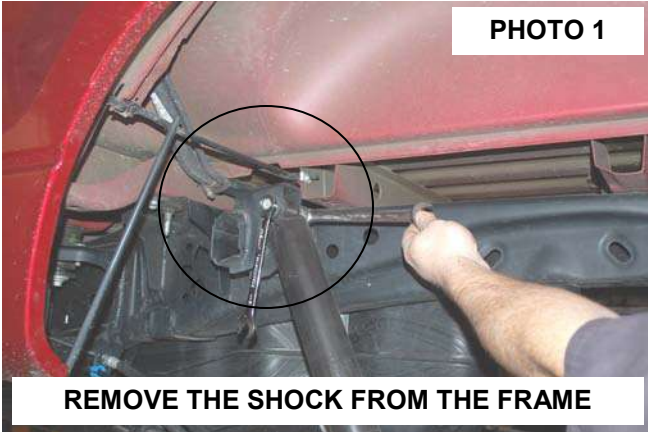

4. Using a 10mm wrench, remove the brake line assembly on the inner driver side frame rail. **See Photo 3.**
5. Install the brake line assembly to the new bracket using the supplied 3/8" x 1" bolt, washers and nut. Tighten using a 9/16" socket and wrench. **See Photo 4.**
6. Install the brake line extension bracket on the frame using the stock hardware and tighten using a 10mm wrench. **See Photo 4.**

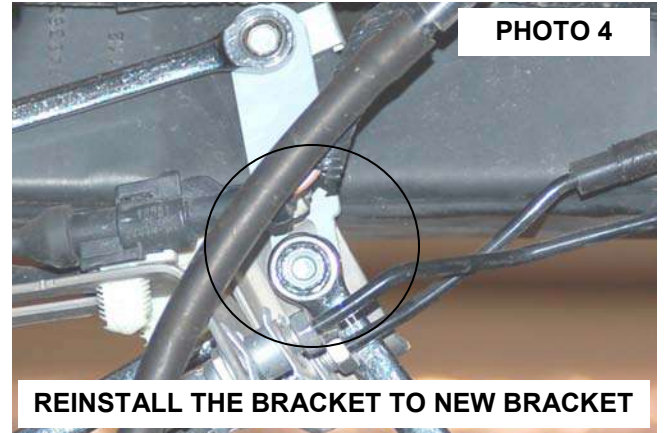
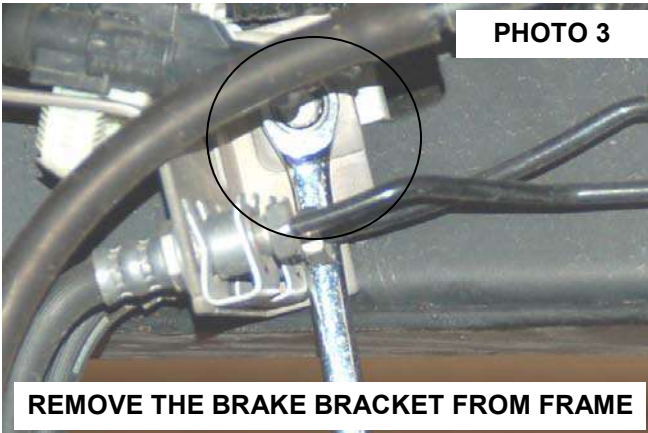

7. Remove the e-brake cable mount with a 10mm wrench as shown on the drivers side as shown in **Photo 5.**
8. Install the supplied e-brake bracket with the factory hardware. Tighten with a 10mm wrench. **See Photo 6.**

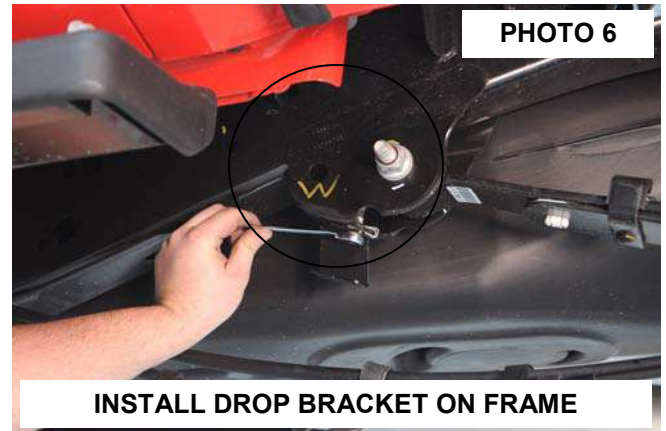
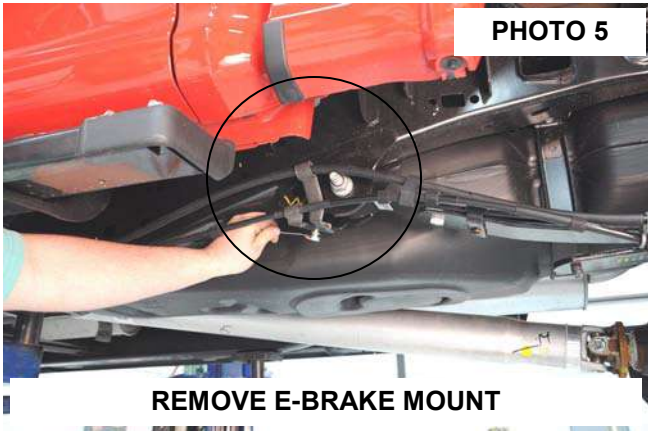

9. Install the e-brake cable mount to the new e-brake drop bracket using the supplied 5/16" bolt, washers, and lock nut. **See Photo 7.**
10. Using a jack support the rear end and remove U-bolts using a 21mm socket and remove the factory blocks. Retain factory block for the 4" kit. **See Photo 8.**



PHOTO 7

INSTALL NEW BRACKET

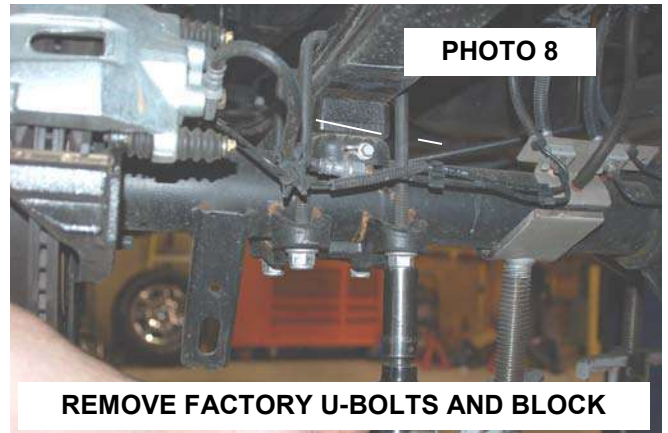

PHOTO 8

REMOVE FACTORY U-BOLTS AND BLOCK

11. Install the supplied blocks on the block pin holes on the axle and raise the axle into place. **See Photo 9.** Note the 4" kit will have a standard block with the factory block while the 5" kit will use the Rough Country Anti-wrap design blocks. **Note- Taller end of block to the rear of the truck!**
12. Install the axle u-bolts and tighten using a 22mm socket.
13. For the 5" kits install the upper leaf spring u-bolts over the leaf spring and into the blocks. Secure with supplied hardware and tighten using a 16mm socket. **See Photo 10.**

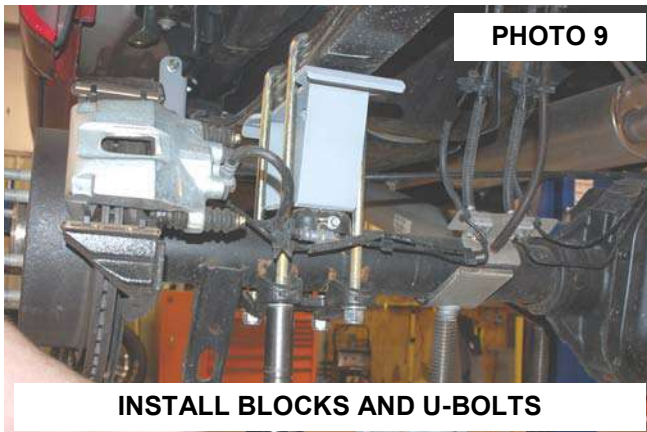

PHOTO 9

INSTALL BLOCKS AND U-BOLTS



PHOTO 10

7/16"

9/16"

14. Install the supplied rear bump stop bracket, if supplied, with the 3/8" x 3.5" round u-bolt, making sure the bracket lines up with the factory bump stop. Tighten with the 3/8" nylock nuts and a 9/16" socket. **See Photo 11.**

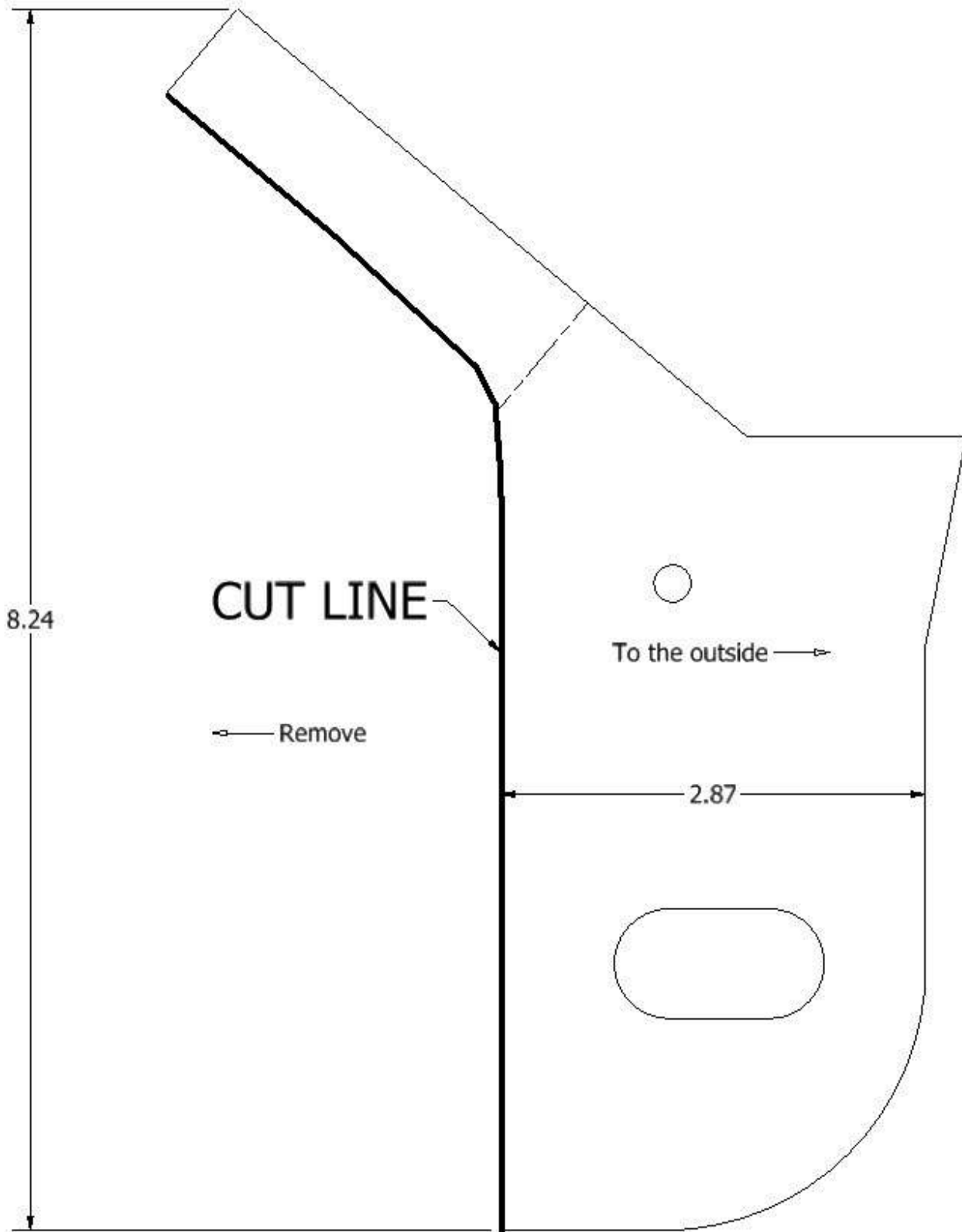

PHOTO 11

INSTALL BUMP STOP AND U-BOLT

15. Install the new shock absorbers in the upper and lower mounts using the stock hardware. Tighten using a 18 and 15mm wrench. **Shocks will mount with the body down.**
16. Install the tire and wheels.
17. Raise up the rear of the vehicle and remove the jack stands. Lower the vehicle to the ground.

CUTTING / DRILLING TEMPLATE—FR SIDE OF DRIVER CROSSMEMBER



CUTTING / DRILLING TEMPLATE—REAR OF DRIVER SIDE CROSSMEMBER

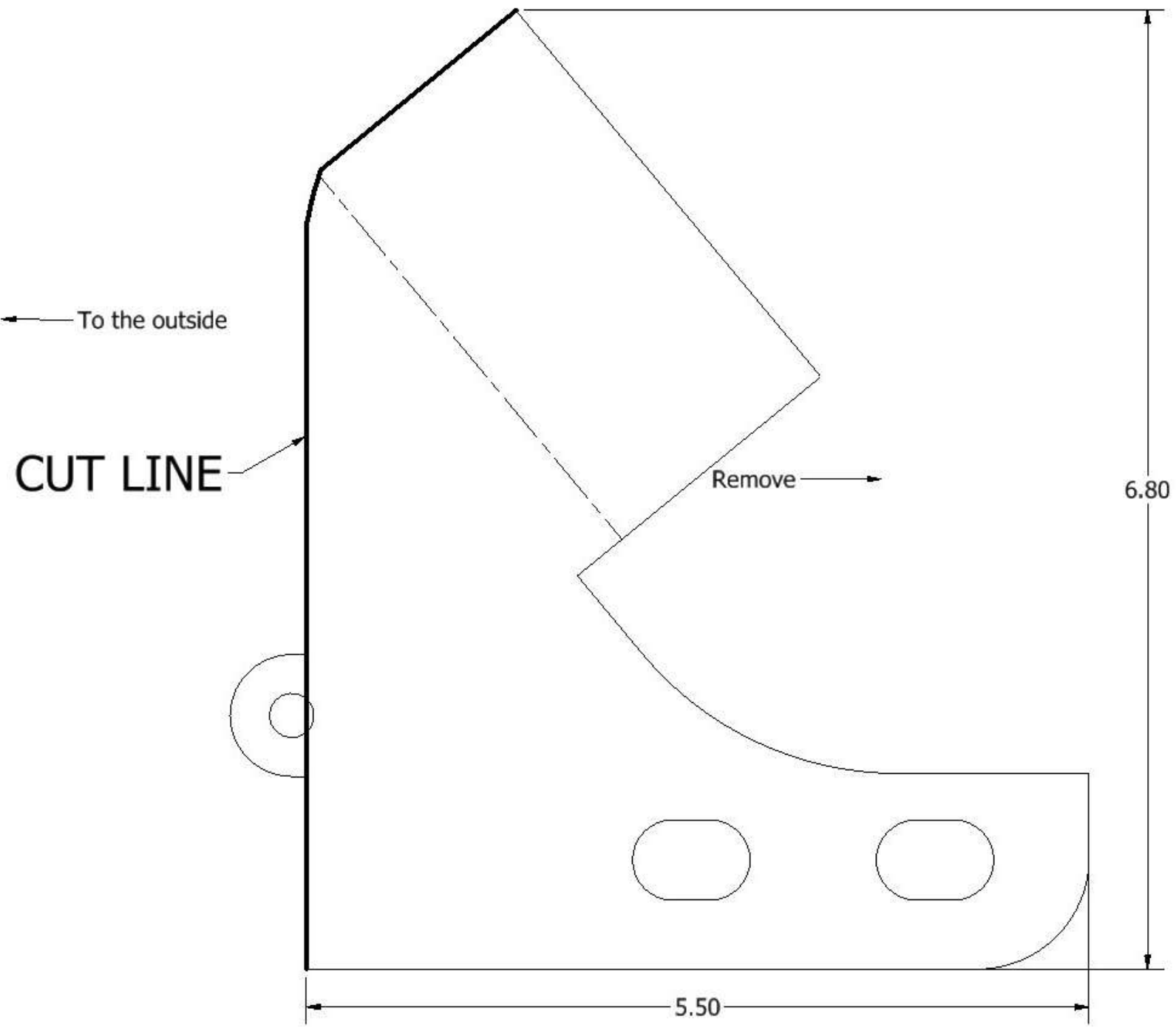

POST INSTALLATION INSTRUCTIONS

1. Check all fasteners for proper torque. Check to ensure there is adequate clearance between all rotating, mobile, fixed and heated members. Check steering gear for interference and proper working order. Test brake system
2. Perform steering sweep. Check to ensure brake hoses have sufficient slack and will not contact rotating, mobile, or fixed members, adjust lines/brackets to eliminate interference and maintain proper working order. Failure to perform inspections may result in component failure
3. Readjust headlights to factory settings
4. Have vehicle aligned by a certified alignment professional.
5. Re-torque all nuts, bolts, and especially u-bolts after the first 100 miles, again after another 100 miles and then check periodically thereafter
6. All components must be retightened after 500 miles, and every three thousand miles after installation.

Thank you for purchasing a Rough Country Suspension System.

By purchasing any item sold by Rough Country, LLC, the buyer expressly warrants that he/she is in compliance with all applicable , State, and Local laws and regulations regarding the purchase, ownership, and use of the item. It shall be the buyers responsibility to comply with all Federal, State and Local laws governing the sales of any items listed, illustrated or sold. The buyer expressly agrees to indemnify and hold harmless Rough Country, LLC for all claims resulting directly or indirectly from the purchase, ownership, or use of the items.

