

ROUGH COUNTRY

SUSPENSION SYSTEMS

2017 F250 6" 4-LINK SUSPENSION KIT

Thank you for choosing Rough Country for your suspension needs.

Rough Country recommends a certified technician installs this system. In addition to these instructions, professional knowledge of disassemble/reassembly procedures as well as post installation checks must be known. Attempts to install this system without this knowledge and expertise may jeopardize the integrity and/or operating safety of the vehicle.

Please read all the instructions before beginning the installation. Check the kit hardware against the parts list. Be sure you have all the needed parts and understand where they go. Also please review the tools needed list and make sure you have needed tools.

⚠ WARNING

As a general rule, the taller a vehicle is the easier it will roll. We strongly recommend seat belts and shoulder harnesses should be worn at all times. Avoid situations where a side rollover may occur.

Braking performance and capabilities are decreased when larger/heavier tires and wheels are used. Also, consider the additional stress introduced on suspension, steering and related components. Take this into consideration while driving. Also, speedometer recalibration is necessary when larger tires are installed.

Do not add, alter, or fabricate any factory or after-market parts which increase vehicle height over the intended height of the Rough Country product purchased. Mixing component brands, lifts, and/or combining body lift with suspension lifts voids all warranties. Rough Country makes no claims regarding lifting devices and excludes any and all implied claims. We will not be responsible for any product that is altered.

Due to vehicle options and ride height variances, the advertised amount of lift is an assumed figure. Final ride height may vary. Always measure vehicle ride height prior to kit installation.

This 6" suspension system was developed for **37x12.50x17** tire on an after market wheel w/ 4.5" back spacing.

⚠ NOTICE

NOTICE TO DEALER AND VEHICLE OWNER

Any vehicle equipped with any Rough country product must have the "Warning to Driver" decal installed on the sun visor or dash. The decal is to act as a constant reminder for whoever is operating the vehicle of its unique handling characteristics. **INSTALLING DEALER**—It is your responsibility to install the warning decal and to forward these installation instructions on too the vehicle owner for review and to be kept in the vehicle for its service life.

⚠ NOTICE

Note to installer : Before installation begins we recommend that a test drive be performed. While driving check for uncommon sounds and/or vibrations . What you feel and hear during the test drive will only magnify once lift kit is installed. Advise you to discuss possible issues identified from drive with customer before proceeding to install this kit.

Tools Needed:

15mm Socket / Wrench
18mm Socket / Wrench
18mm Socket / Wrench
19mm Socket / Wrench
21mm Socket / Wrench
24mm Socket / Wrench
30mm Socket / Wrench
46mm or 1-13/16" Socket
5/8" Socket / Wrench
3/4" Socket / Wrench

10mm Socket / Wrench
12mm Socket / Wrench
1 7/8" Socket / Wrench
Pliers
Coil Spring Compressor
Pitman Arm Puller
Jack Stands
Jack
Torque Wrench

Torque Specs:

Size	Grade 5	Grade 8
8MM	18ft/lbs	23 ft/lbs
5/16"	15 ft/lbs	20 ft/lbs
3/8"	30 ft/lbs	35 ft/lbs
7/16"	45 ft/lbs	60 ft/lbs
1/2"	65 ft/lbs	90 ft/lbs
9/16"	95 ft/lbs	130 ft/lbs
5/8"	135 ft/lbs	175 ft/lbs
3/4"	185 ft/lbs	280 ft/lbs



Kit Contents:

- 9296 Coil Springs
- 1560Box2 Fixed Upper Control Arms (A)
- 1560Box3 Adj Lower Control Arms (B)
- 1560Box1 Track Bar Bracket (C)
- Control Arm Bracket (D)
- Sway Bar Link (E)
- Sway Bar Link (F)
- Pitman Arm (G)
- Dr Brake Line Bracket (H)
- Pass Brake Line Bracket (I)
- Frame Mount Stab Brkt (J)
- Bar Mount Stab Brkt (K)
- Fr Bump Stop Spacers (L)
- RR Brake Brkt (M)
- 155020 N2 Fr Shock Absorbers (N)
- N2 Rr Shock Absorbers (O)
- 1563Box3 or 1550BOX2 Rr Anti-Wrap Blocks (P)
- U-bolts (Q)
- Spring Top Plates (2) ®
- 7673 or 7675 Ubolts for 4" Rear Axles

Kit Bags:

- 1580Bag4-Qty 2**
For Upper and Lower Arms:
8-Bushings
4-Sleeves
- 1580Bag3-**
For Lower Adj Arms:
2-Jam Nuts
- 1565Bag1-**
For Upper and Lwr Arms
2-Crush Sleeves
6-3/4" x 5" Bolts
6-3/4" Lock Nuts
12-3/4" Flat Washers
- For Fr Bump Stops:
2-8mm x 95mm Bolts
2-8mm Flat Washers
- For Rear Brake Line Brkt:
1-7/16" x 1" Bolt
1-7/16" Lock Nut
2-7/16" Flat Washers

1550Bag2-

- For Front Brake Line Brckts:
2-5/16" x 3/4" Bolts
2-5/16" Washers
2-5/16" Flange Nuts
- For Steering Stabilizer Relocation:
1-1/2" x 1.75" Bolt
1-1/2" Nylock Nut
1-1/2" Washer
1-5/16" Ubolt
2-5/16" Flange Nuts
1-12mm x 55mm Bolt
1-12mm Flange Nut
- For Sway Bar Links:
4-1/2" x 1.5" Bolts
4-1/2" Washers
4-1/2" Nuts
4-12mm x 65mm bolts
4-12mm Nuts
- 1481Bag1-**
For Rear Spring U-bolts:
8-7/16" Lock Nuts
8-7/16" Flat Washers
- For Rear Axle U-bolts:
8-5/8" Lock Nuts

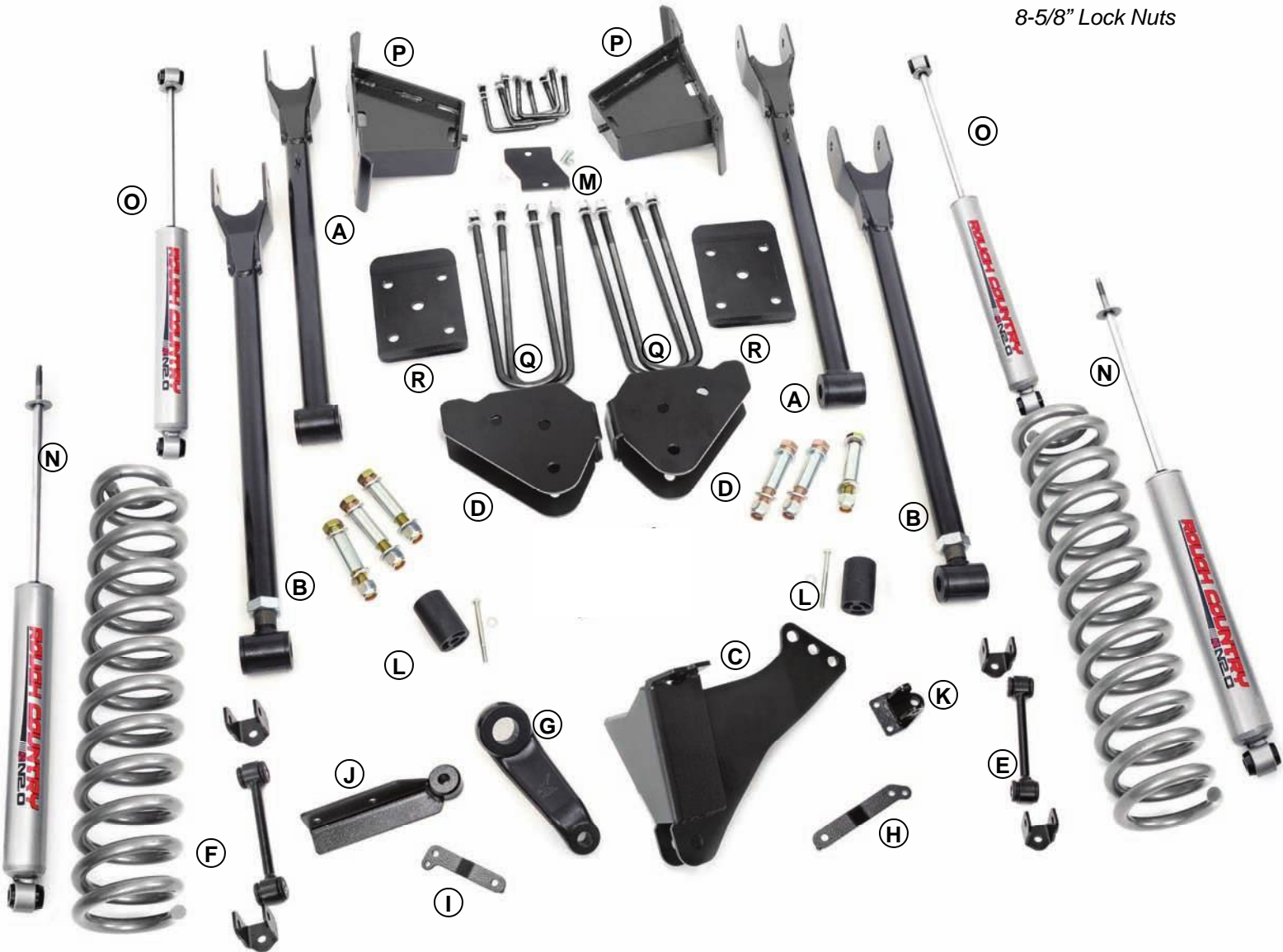

FRONT INSTALLTION INSTRUCTIONS

1. Block the rear wheels of the vehicle. Raise the front of the vehicle and support the frame with jack stands. Remove the front wheels and tires, using a 21mm socket, and set aside. Position a hydraulic jack under the front axle and raise the jack until the front suspension begins to compress.
2. Disconnect the track bar from the driver side frame bracket, using a 30mm wrench. **See Photo 1.**
3. Remove the bump stop from the cup shaped bracket. Remove the bracket from the frame rail. **See Photo 2.**

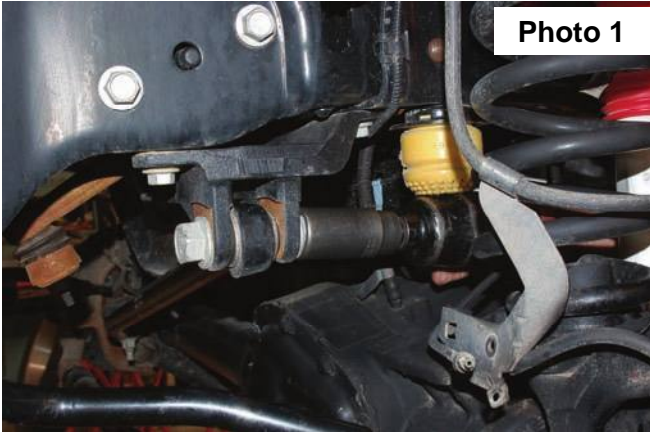

4. Using a 13mm socket, remove the brake line bracket from the frame. **See Photo 3.**
5. Remove the ABS wire from the brake line bracket. **See Photo 4.**

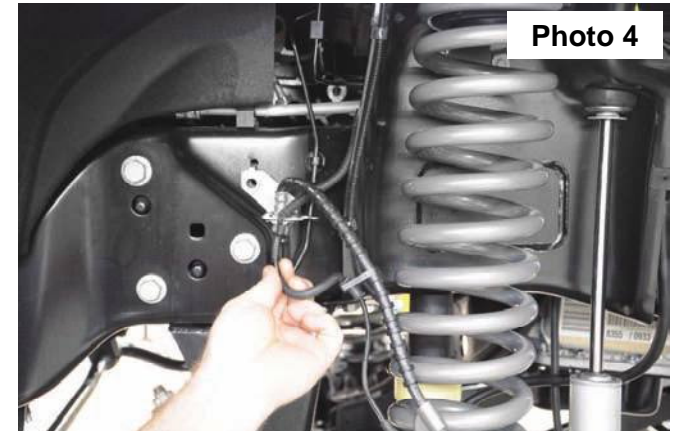
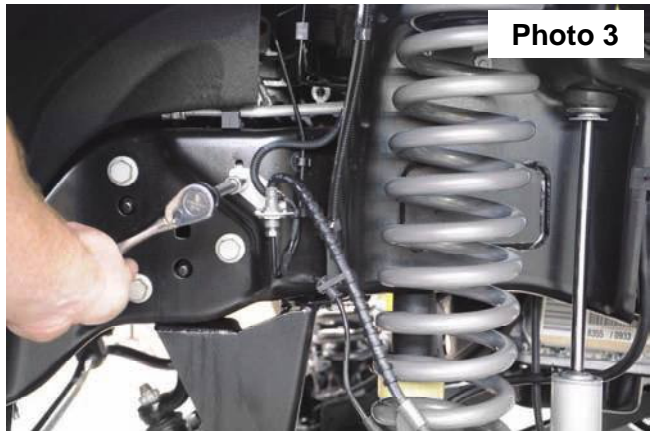

6. Carefully bend the brake line towards the coil. Install the new driver side brake line bracket on the frame using the factory hardware. Attach the brake line to the extended bracket using the 5/16" x 3/4" supplied bolt, washer and nut. **See Photo 5.**
7. Repeat the process on the passenger side brake line. **See Photo 6.**
8. Using an 18mm wrench remove the sway bar links from the truck.

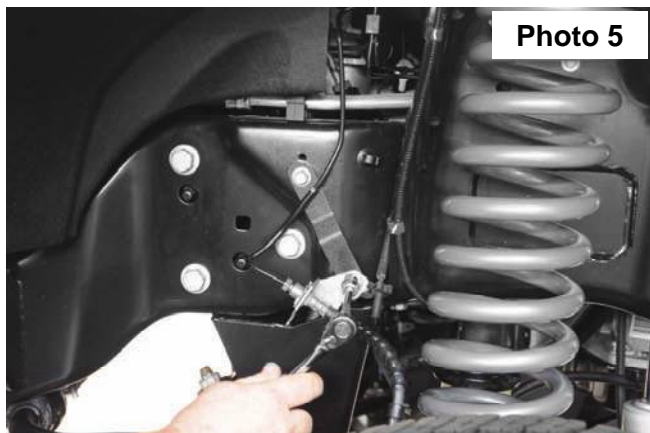

9. Using 18mm and 19mm wrenches, remove the front shocks.
10. Using 18mm and 15mm wrenches, remove the factory steering stabilizer from the truck.
11. Carefully lower the jack until the coil springs are free. Remove the coil springs from the vehicle. **Note:** Use of a coil spring compressor may be required for spring removal.

- Support both driver and passenger radius arms with jack stands. Using a 24mm wrench, and socket remove the bolts holding the radius arm to the axle. Retain stock hardware for re-use. **See Photo 7.**
- Using a 24mm wrench, and socket remove the bolt holding the radius arm to the frame. **See Photo 8.**



- Insert bushings, and sleeves from kit bag into the upper control arm. **See Photo 9.**
- Insert the radius arm drop bracket into the stock location. Bolt into place using the supplied 3/4" x 4.75" bolt, crush sleeve, nut and washer in the bracket. Do not tighten at this time. **See Photo 10.** It may be necessary to use a 3/4" drill to open the holes in the frame mounts.

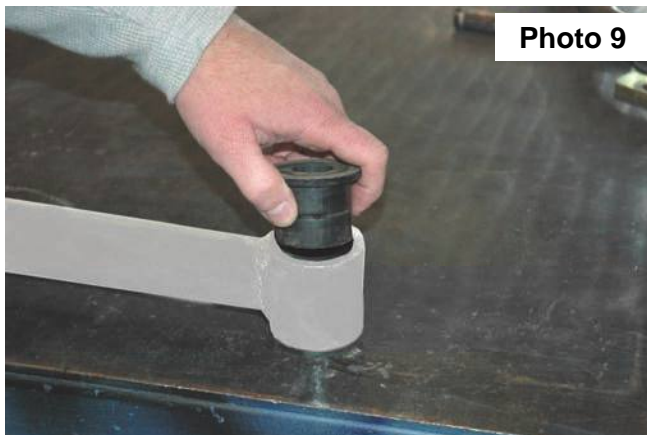

- Attach the control arms to the axle using the stock hardware. **See Photo 11.** It may be necessary to use the rear nut from the frame mount due to some models having the radius arm nut welded to the radius arm.
- Attach the upper control arm to the radius arm bracket in the top hole. Bolt into place using the supplied 3/4" x 4.75" bolt, nut and washer provided in the kit bag. Do not tighten at this time. **See Photo 12.**



- Adjust the arm to a measurement of 35 5/8" from center hole to center hole. Tighten the jam nut using a 1 7/8" wrench.

19. Attach the lower control arm to the axle using the stock hardware. **See Photo 13.** Do not tighten at this time.
20. Insert the joint end of the lower control arm into the radius arm drop bracket. Bolt into place using a 3/4" x 4.75" bolt, nut and washer provided in the kit bag. **See Photo 14.**

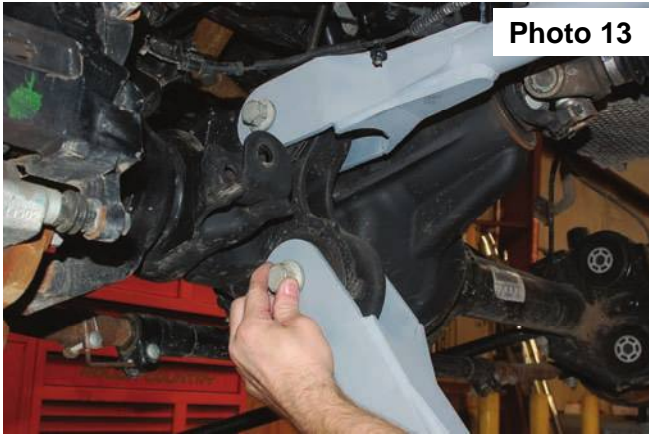

Photo 13

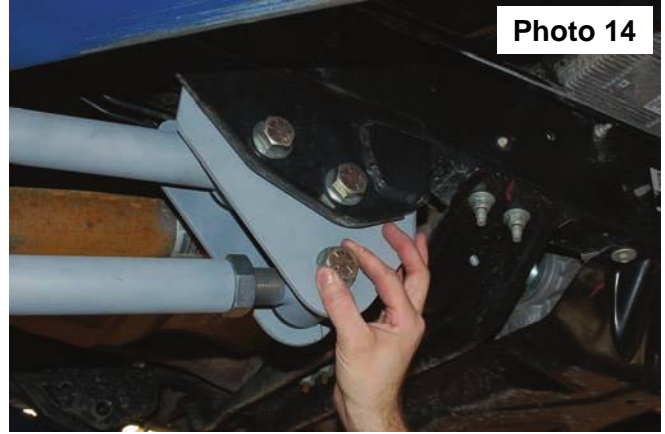

Photo 14

21. Repeat step 12-20 on the opposite side.
22. Using the nylon bump stop extension provided, place the extension between the frame and the bump stop cup. Bolt back into the original location using the supplied 8mm x 95mm bolt. Torque to 15 ft. lbs using a 12mm wrench. Re-install the factory bump stop in the bump stop cup. **See Photo 15.**
23. Using a 21mm wrench and 19mm socket remove the factory track bar bracket from the frame. Retain stock hardware for re-use.
24. Remove the cotter pin and nut using a 24mm wrench, from the drag link end where it attaches to the pitman arm. **See Photo 16.**

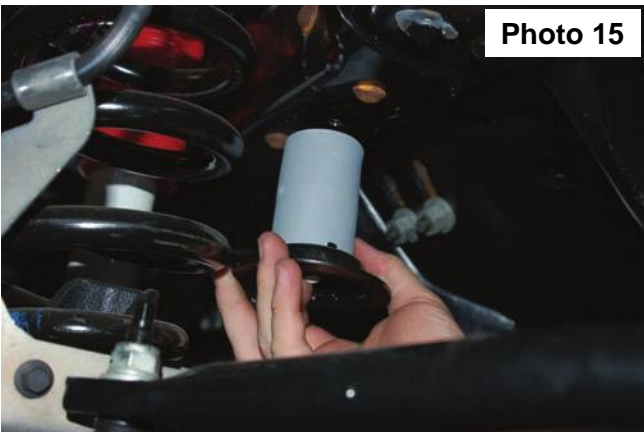

Photo 15

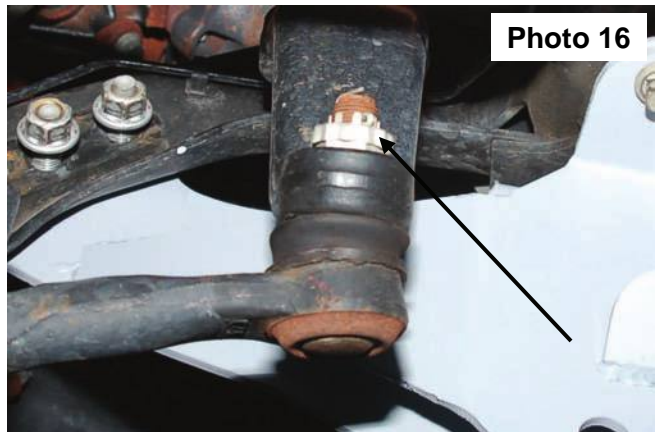

Photo 16

25. Dislodge link with a tie rod end puller. Note: Replace the link if any stud looseness is detected, or if you can twist the studs in its socket with your fingers.
26. Using a 46mm or 1-13/16" socket, remove the nut from the steering sector and remove the pitman arm with a puller tool. Inspect the spline on the shaft for excessive wear, repair if needed.
27. Using 15mm and 13mm wrenches, loosen the drag link adjustment collar.
28. Spin the drag link over so the tie rod end is pointing up.
29. Remove the collar lock bracket from the truck and torque the adjustment collar to factory specs.
30. Install new arm, lock washer, and nut. Using a 46mm or 1-13/16" socket, torque nut to factory specs.
31. Attach the drag link stud to the pitman arm. Torque nut to factory specs, and install cotter pin. Check for adequate linkage clearances while turning steering wheel full lock in both positions.

33. Position the Rough Country track bar bracket on the frame in the same position as the original and secure using the factory hardware. Torque to factory specs. **See Photo 17.**
34. Lower the front axle enough to install the new coil springs. Position the coil springs in the lower coil buckets on the axle and rotate as necessary to be sure that the pigtail of the coil is indexed properly in the bucket. Position the factory rubber isolator on top of each coil, then raise the axle enough to seat the coil springs in the upper spring buckets.
35. Compress the front springs enough to install the front shocks, 658787. Bolt the lower end of the shock to the axle using the stock hardware using a 18mm wrench. Attach the upper end of the shock with the stock hardware, using a 19mm wrench. Tighten only enough to bulge the bushing.
36. Using a 13mm socket, remove the stabilizer mount from the frame. **See Photos 18 & 19.**

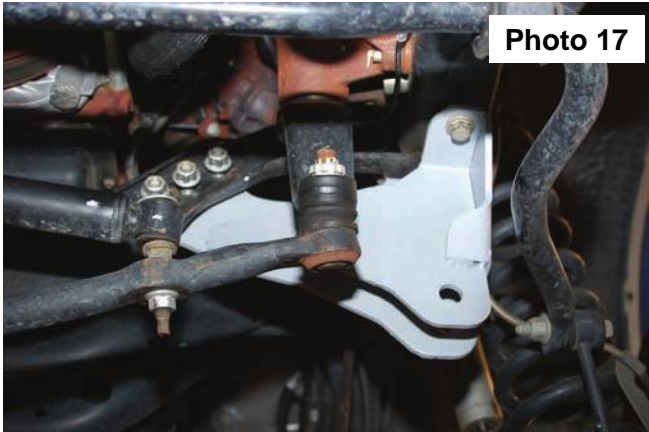

Photo 17

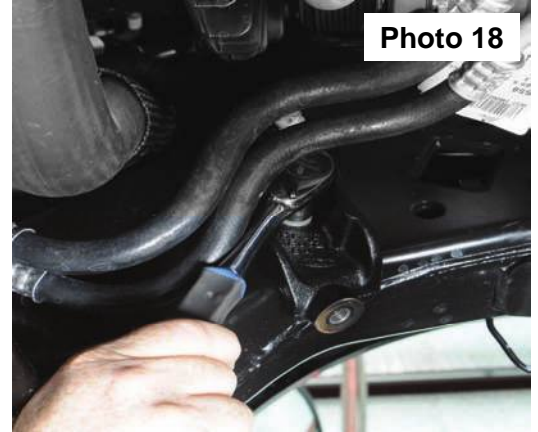

Photo 18

37. Install the new stabilizer bracket on the frame using the factory bolts, torque to factory specs with a 13mm socket. **See Photo 20.**

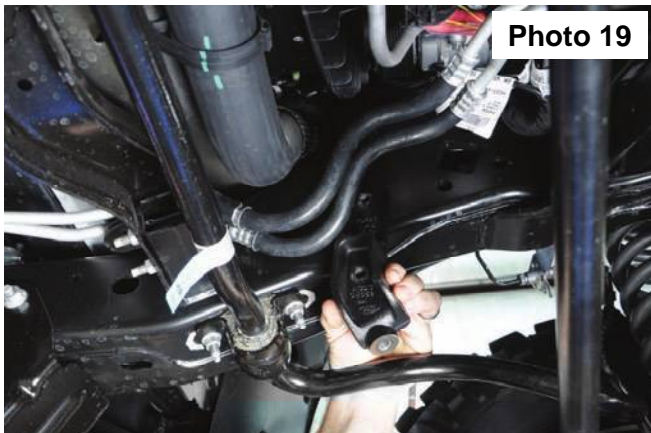

Photo 19

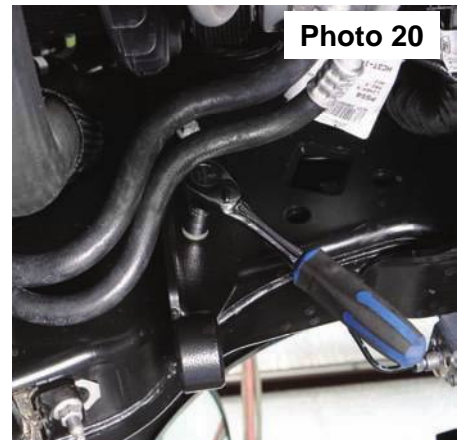

Photo 20

38. Install the stabilizer bracket on the drag link using the supplied .5" x 2" bolt, washer and nut also using the supplied ubolt and nuts. **See Photo 21.**
39. Install the stabilizer on the drag link mount using the supplied 12mm x 55mm bolt and nut. **See Photo 22.**

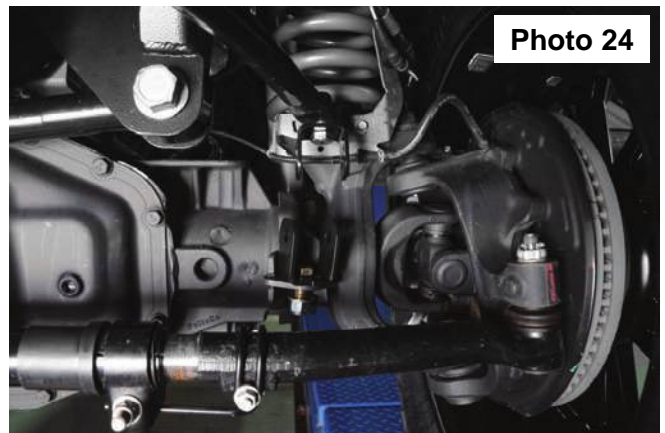

Photo 21

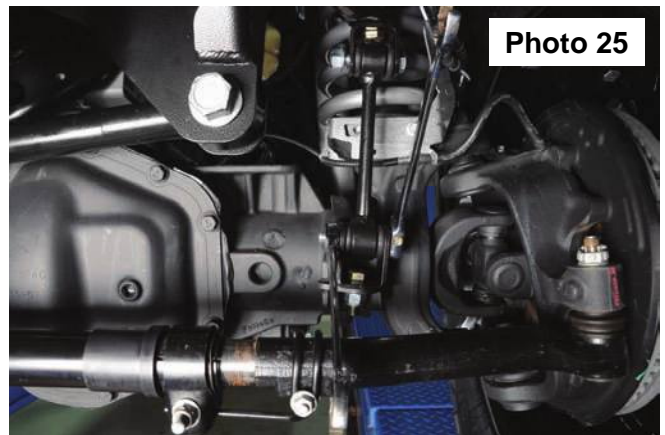

Photo 22

40. Install the stabilizer on the frame mount using the factory hardware. **See Photo 23.**
41. Tighten using 18mm and 19mm wrenches.
42. Install the supplied upper and lower sway bar link mounts using the supplied 1/2" x 1.5" bolts washers and nuts. Tighten using 3/4" wrenches. **See Photo 24.**



43. Install the sway bar links into the brackets using the supplied 12mm x 65mm bolts, washers, and nuts. Tighten using 18mm and 19mm wrenches. **See Photo 25.**
44. Install tires and wheels and lower the vehicle to the ground.
45. Line up the track bar with the hole in the new track bar bracket. You may have to start the truck and turn the wheels in the direction the track bar needs to go to help align the track bar with the hole. Install using the stock track bar bolt. Tighten bolt. Torque to factory specs.
46. Torque the radius arm bolts to factory specs.



REAR INSTALLATION

1. Chock front wheels and jack up the rear of the vehicle. Secure with jack stands on the frame rail. Using a 21mm socket, remove the rear tires and wheels.
2. Place a floor jack under the rear differential on the rear axle. Using a 18mm wrench for the upper, and 19mm and 15mm wrench for the lower, remove the stock shock absorbers, retain the stock hardware for reuse.
3. Remove the diff vent hose from the differential. **See Photo 1.**
4. Remove the diff vent tube using a 5/8" wrench. Retain the vent tube for reuse. **See Photo 2.**



Photo 1



Photo 2

5. Install the supplied bracket in the stock location using the stock hardware. Tighten using a 5/8" wrench. **See Photo 3.**
6. Install the stock brake line bracket to the new bracket with the supplied 7/16" x 1" Bolts, washers and lock nuts and tighten using 5/8" wrench. Reinstall the diff vent hose as shown. **See Photo 4.**



Photo 3



Photo 4

7. Using a 24mm socket, remove the stock u-bolts. Use the floor jack to lower the axle assembly to allow for lifted block installation.
8. Using C-clamps, clamp the spring pack on each side of the center pin.
9. Using locking pliers, lock onto the bottom of the center pin. **See Photo 5.**

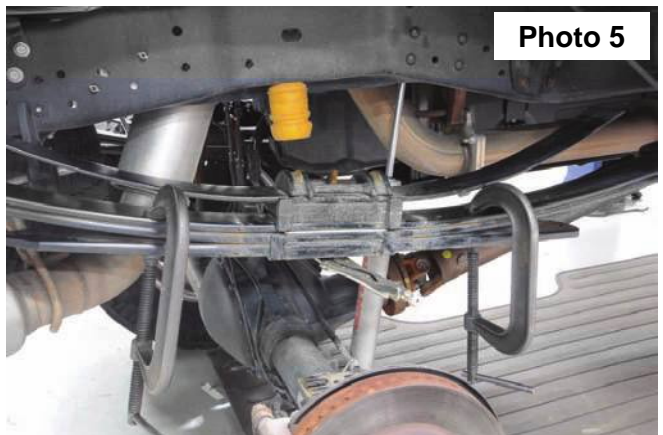

Photo 5

10. Using a 9/16" socket, remove the nut from the center pin. **See Photo 6.**

11. Remove the factory ubolt plate. **See Photo 7.**

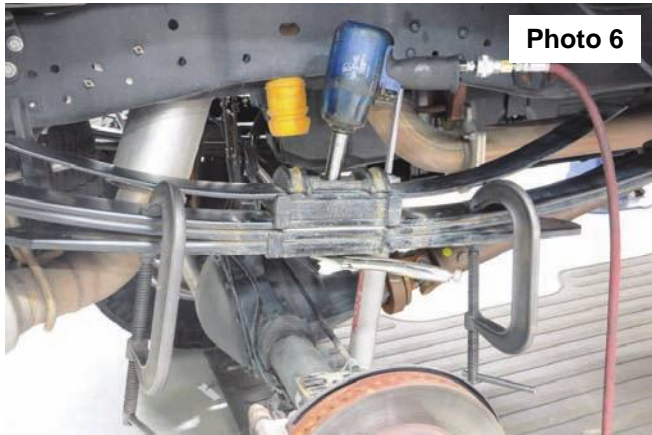

Photo 6

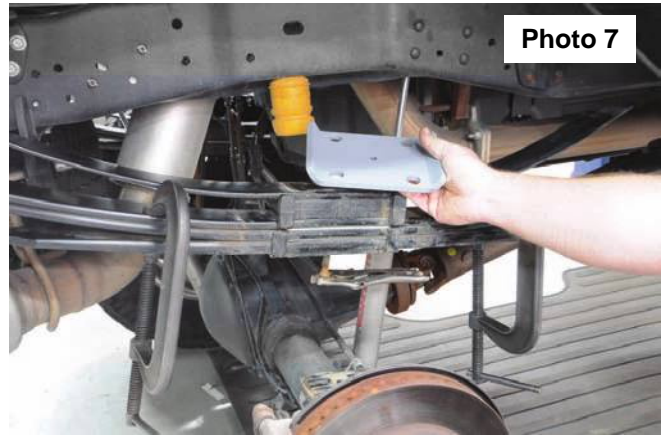

Photo 7

12. Using the stock hardware, attach the supplied ubolt plate and tighten the center pin using a 9/16" socket. **See Photo 8.**

13. Install the supplied shim plates between the block and the leaf spring. Install the supplied 7/16" square ubolts and hardware. Tighten using a 5/8" socket.

14. Install the new supplied 3/4" ubolts from the bottom. Use the supplied 3/4" hardware and tighten using a 1-1/8" socket. **See Photo 9.**

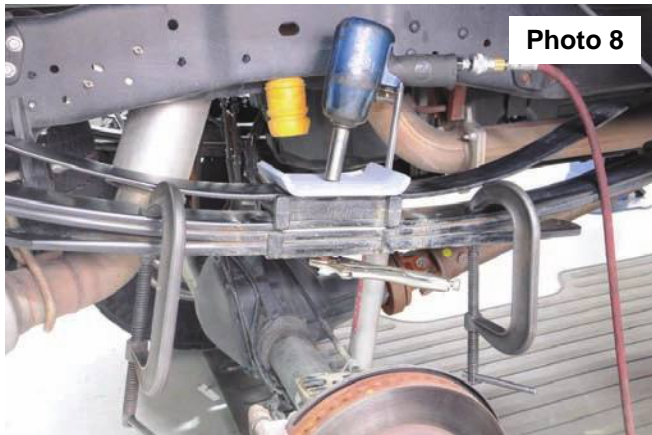

Photo 8

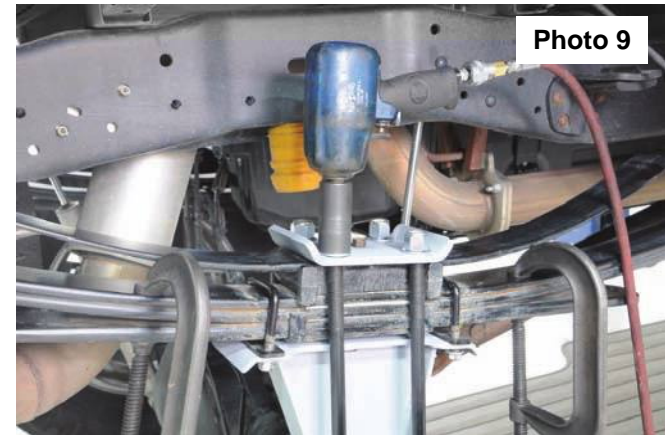

Photo 9

15. Locate shock part number 658887 gas shock and install using factory hardware on upper and lower shock mount. Tighten using a 18mm wrench for the upper and a 19mm and 15mm wrench for the lower. Torque to factory specs.

16. Install the tires and wheels.

17. Jack up the rear of the vehicle and remove the jack stands. Lower the vehicle to the floor.

18. With the weight of the vehicle on the axle, torque the u-bolts to 130-150 ft-lbs.

19. Check all hardware for proper torque.

POST INSTALLTION INSTRUCTIONS

1. Have a qualified alignment center realign front end to
Caster min- 4.0 degree
Camber -0.6—.09 degree
Toe -.10- .15 degree
2. Install Warning to Driver decal on sun visor.
3. Re-torque all nuts, bolts, and especially u-bolts after the first 100 miles, again after another 100 miles and then check periodically thereafter.
4. All components must be retightened after 500 miles, and every three thousand miles after installation
5. Adjust headlights to proper settings.

▲ NOTICE Double check all nuts and bolts. Refer to torque specs on front page of instructions.

▲ NOTICE With the vehicle on the ground and the weight on the tires, cycle the steering from lock to lock making sure there is no interference. Inspect the suspension, brake lines, wiring, drivelines, and fuel lines for correct tightness, location and clearance from any moving parts.

Drive line vibrations may be experienced depending on stock vehicle ride heights. Drive line angles may require adjusting, shafts may need to be lengthened or trued, and u-joints may need to be replaced.

Thank you for choosing Rough Country for your suspension needs.

By purchasing any item sold by Rough Country, LLC, the buyer expressly warrants that he/she is in compliance with all applicable , State, and Local laws and regulations regarding the purchase, ownership, and use of the item. It shall be the buyers responsibility to comply with all Federal, State and Local laws governing the sales of any items listed, illustrated or sold. The buyer expressly agrees to indemnify and hold harmless Rough Country, LLC for all claims resulting directly or indirectly from the purchase, ownership, or use of the items.



ROUGH COUNTRY

SUSPENSION SYSTEMS

55000BAG

Ford 2017 F250 Transfer Case Clocking Ring

Thank you for choosing Rough Country for all your suspension needs.

▲WARNING Rough Country recommends a certified technician install this system. In addition to these instructions, professional knowledge of disassemble/reassembly procedures as well as post installation checks must be known. Attempts to install this system without this knowledge and expertise may jeopardize the integrity and/or operating safety of the vehicle. Please read instructions before beginning installation. Check the kit hardware against the kit contents. Be sure you have all needed parts and know where they go. Also please review tools needed list and make sure you have needed tools.

PRODUCT USE INFORMATION

▲WARNING Do not add, alter, or fabricate any factory or after-market parts to increase vehicle height over the intended height of the Rough Country product purchased. Mixing component brands is not recommended. Rough Country makes no claims regarding lifting devices and excludes any and all implied claims. We will not be responsible for any product that is altered.

▲WARNING DEALER AND VEHICLE OWNER

Install the supplied "Warning to Driver" decal installed on the inside of the windshield or on the vehicle's dash. The decal should act as a constant reminder for whoever is operating the vehicle of its unique handling characteristics.

Tools Needed:

Wheel Chocks	Pliers
Ratchet	7/16" Socket & wrench
6mm Allen Socket	9/16" Socket
8mm Socket	5/8" Socket
12mm 12pt Socket	11/16" Socket
13mm Socket	Torque Wrench
18mm Socket	
21mm Socket	

Torque Specs:

Size	Grade 5	Grade 8
3/8"	30 ft/lbs	35 ft/lbs
7/16"	45 ft/lbs	60 ft/lbs
1/2"	65 ft/lbs	90 ft/lbs
9/16"	95 ft/lbs	130 ft/lbs
	Class 8.8	Class 10.9
6MM	5 ft/lbs	9 ft/lbs
8MM	18ft/lbs	23 ft/lbs
10MM	32ft/lbs	45ft/lbs
12MM	55ft/lbs	75ft/lbs

INSTALLATION INSTRUCTIONS

1. Chock the wheels.
2. Using a 13mm socket, remove the 4 bolts from the transfer case skid plate. **See Photo 1.**
3. Mark the front driveshaft and pinion yoke. **See Photo 2.**

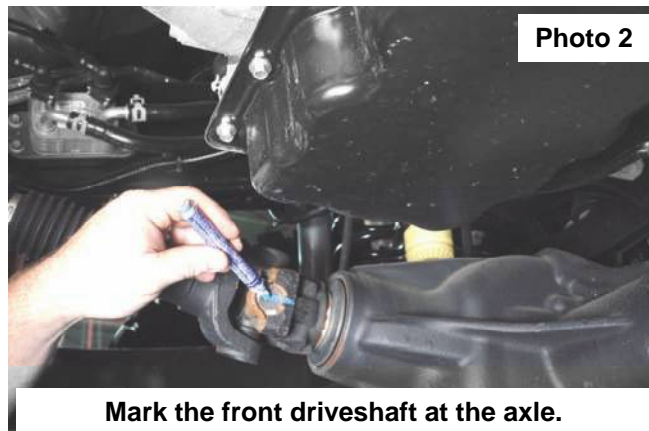
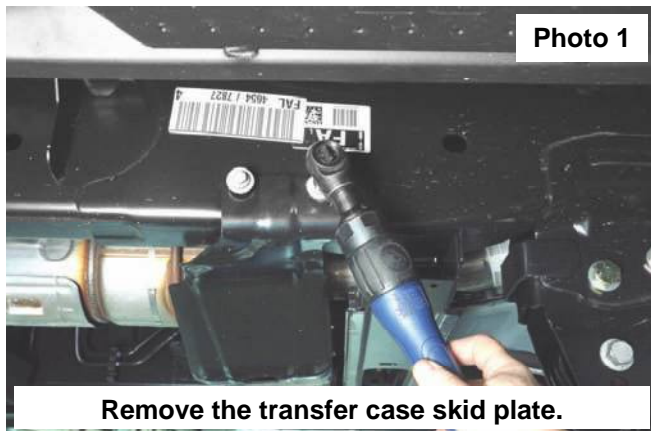

3. Mark the front driveshaft at the transfer case and the transfer case yoke. **See Photo 3.**
4. Mark the rear driveshaft at the rear end. **See Photo 4**



Photo 3

Mark the front driveshaft at the transfer case.



Photo 4

Mark the rear driveshaft at the axle.

5. Using a 8mm socket, remove the front driveshaft from the front axle. **See Photo 5.**
6. Using a 12mm 12-point socket, remove the front driveshaft from the transfer case. **See Photo 6.**

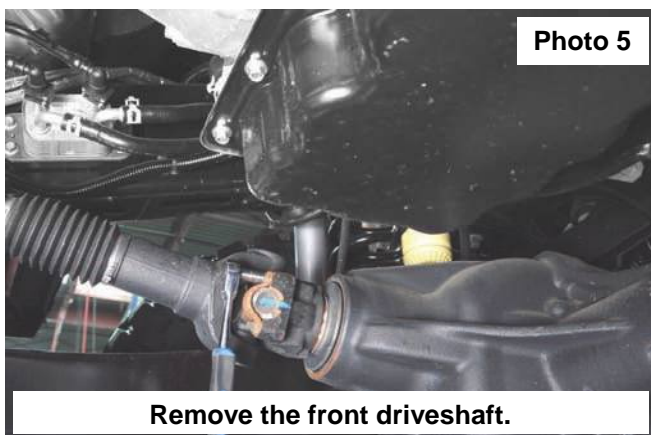

Photo 5

Remove the front driveshaft.

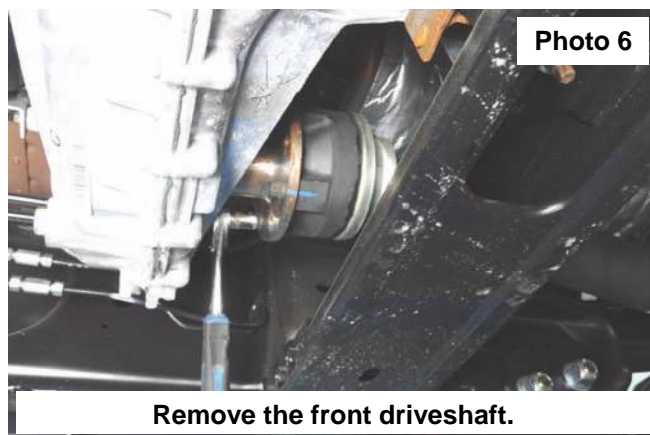

Photo 6

Remove the front driveshaft.

7. Using a 12mm 12-point socket remove the rear driveshaft from the rear axle. **See Photo 7.**
8. Unplug the transfer case actuator. **See Photo 8.**

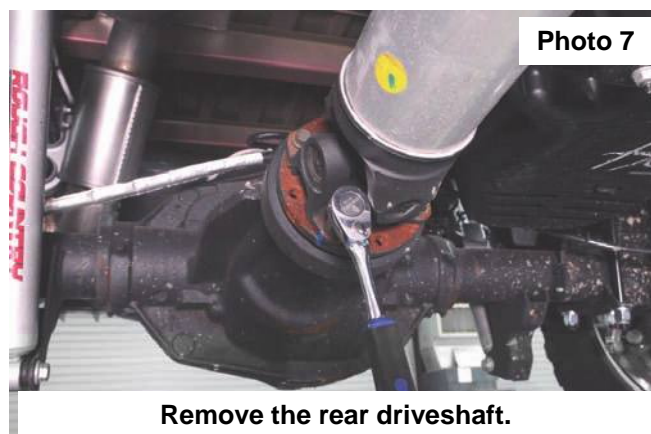

Photo 7

Remove the rear driveshaft.

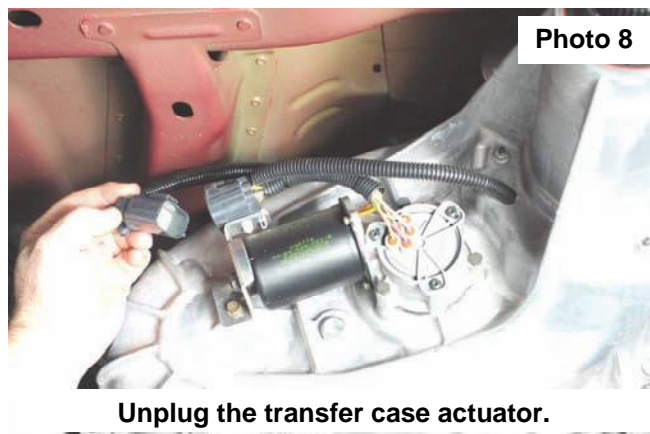
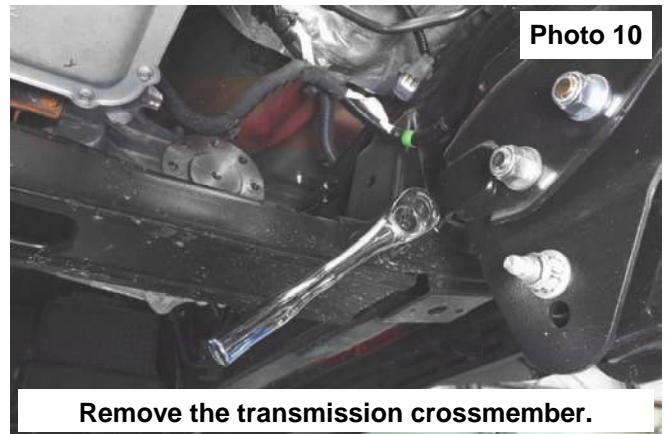
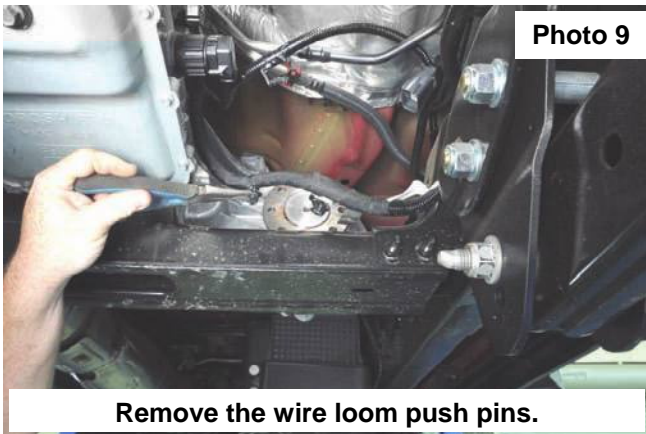

Photo 8

Unplug the transfer case actuator.

9. Using a pair of pliers, remove the push pin clip holding the wire to the transfer case and the transmission crossmember and remove the vent tube from the transfer case. **See Photo 9.**
10. Support the transmission and use a 18mm wrench and 21mm socket to remove the transmission crossmember bolts from the frame. **See Photo 10.**



11. Using a 13mm socket, remove the transmission crossmember from the mount then remove the mount from the transmission. **See Photo 11.**
12. Support the transfer case using a jack or jackstand. Using a 13mm socket, remove the 11 mounting bolts and remove the transfer case. **See Photo 12.**

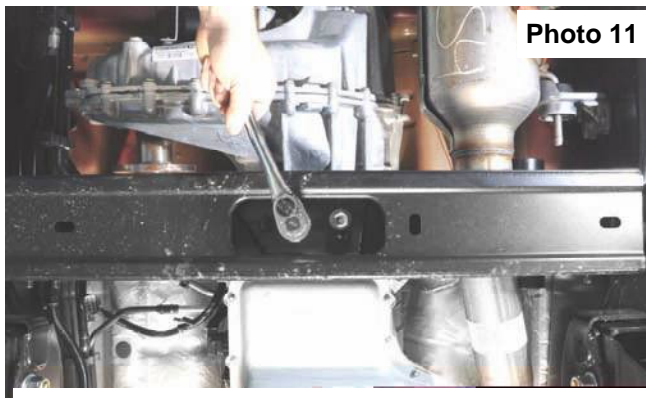

Remove the crossmember from the trans.



13. Place the stud into the clocking ring and the supplied 9/16" nut over the stud, then the supplied 7/16" washer and finally the supplied 7/16" non-locking nut. Using a 11/16" socket & ratchet to tighten the 7/16" nut, pulling the stud into the clocking ring **See Photo 13.**
14. Repeat this process to install the remaining 10 studs into the clocking ring making sure that all studs are flush with the clocking ring. Test fit on the transfer case to make sure the clocking ring sits flush on the transfer case **See Photo 14.**

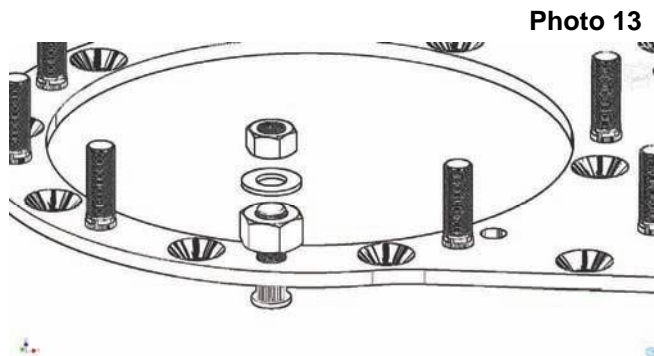

Install the studs in the clocking ring.



15. Install the clocking ring on the transmission using the 11 supplied 10mm x 25mm flat head Allen bolts and a mild thread locker. Torque to 32ft-lbs using a 6mm Allen socket. **See Photo 15.**
16. Attach the supplied wire loom bracket to the top of the transfer case using the supplied 1/4" x 1" bolt washer and nut. Tighten using a 7/16" socket and wrench. **See Photo 16.**

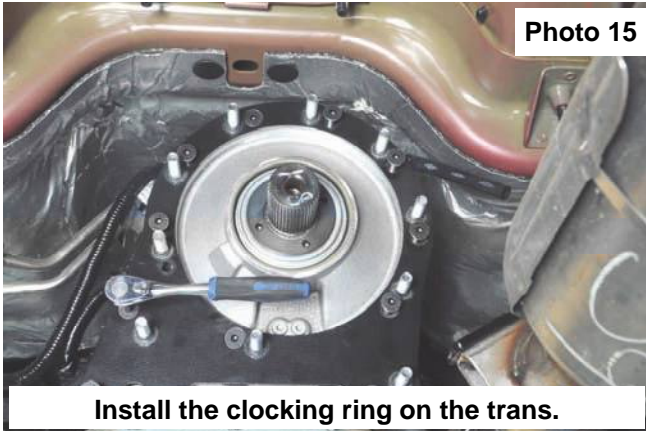

Install the clocking ring on the trans.

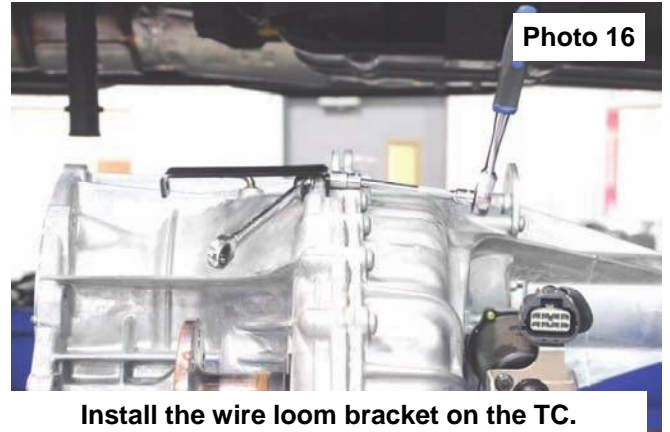

Install the wire loom bracket on the TC.

17. Install the transfer case using the supplied 7/16" nuts and washers. Torque to 45ft-lbs using a 11/16" socket. **See Photo 17.**
18. Install the transmission correction mount using the stock hardware. Torque to factory specs using a 13mm socket. **See Photo 18.**

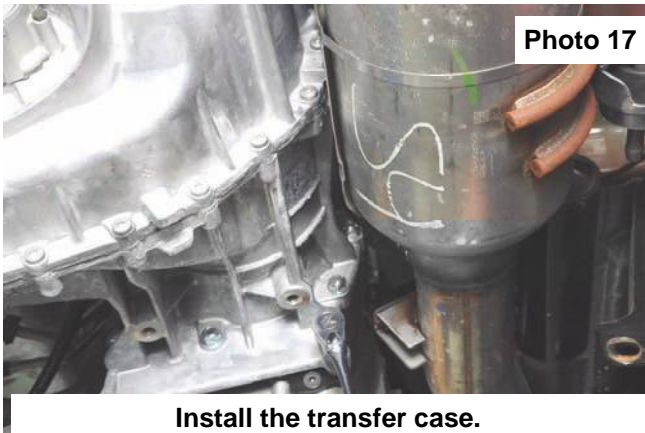

Install the transfer case.

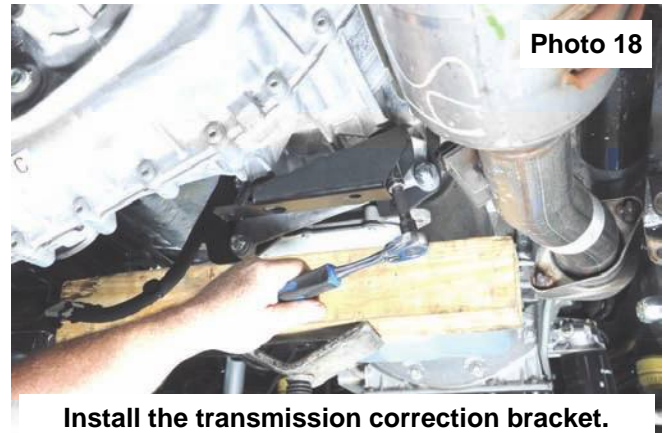

Install the transmission correction bracket.

19. Attach the transmission mount to the correction mount using the supplied 7/16" x 1" bolts, washers, and nuts. Torque to 60ft-lbs using a 5/8" and 11/16" socket. **See Photo 19.**
20. Install the New transmission crossmember (cutout in the crossmember is for driveshaft clearance) using the stock hardware. Torque to factory specs using a 18mm socket. **See Photo 20.**

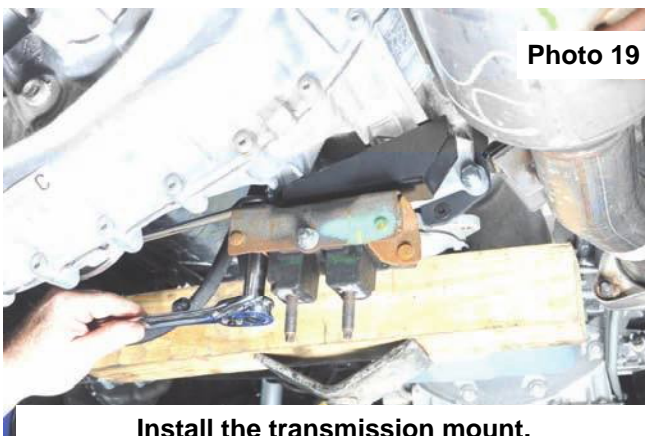

Install the transmission mount.



Install the transmission crossmember.

21. Torque the transmission mount to factory specs using a 21mm socket. **See Photo 21.**
22. Reinstall all wiring push pins (one push pin will go in the supplied wire loom bracket), plug in the transfer case actuator, and the vent tube.
23. Install the front and rear drive shafts, making sure to align the marks made before disassembly. Torque all hardware to factory specs.
24. Install the transfer case skid using the stock hardware on the passenger side and the supplied drop bracket on the driver side using the stock hardware and the supplied 3/8" x 1" bolts, washers and nuts. **See Photo 22.**

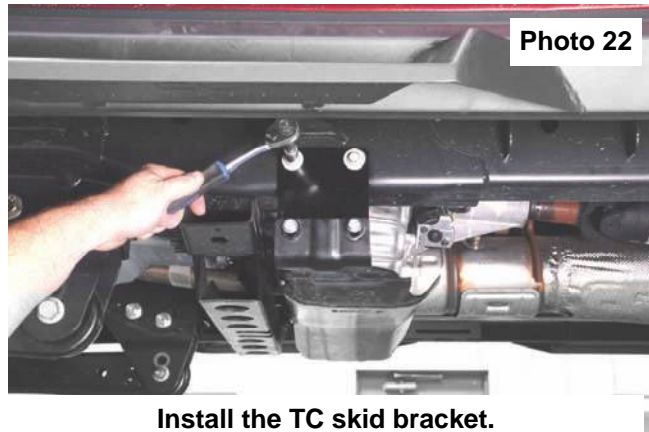

25. Torque the factory hardware to factory specs using a 13mm socket and the supplied 3/8" hardware to 30ft-lbs using a 9/16" socket and wrench. **See Photo 23.**

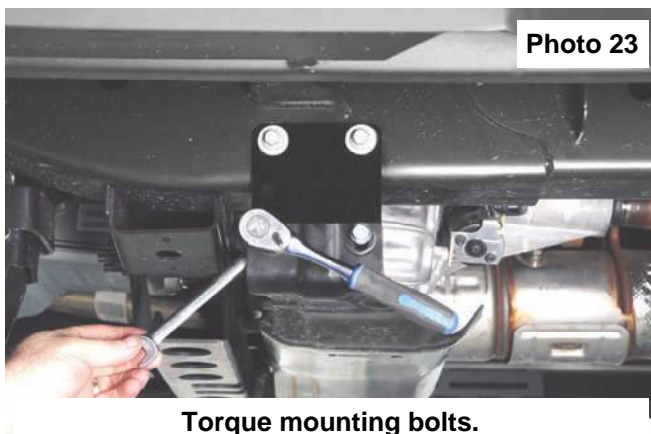

POST INSTALLATION INSTRUCTIONS

1. Check all fasteners for proper torque. Check to ensure for adequate clearance between all components.
2. Check and retighten wheels at 50 miles and again at 500 miles. Periodically check all hardware for tightness.
3. Install "Warning to Driver" decal on sun visor.

Kit Picture

Kit Contents:

1-Transfer Case Clocking Ring
1-Transmission Crossmember
1-Transfer Case Mount Relocation Bracket
1-Transmission Skid Drop Bracket
1-Wire Loom Bracket
1-55000BAG1

55000BAG1:

For Clocking Ring:

1-9/16" Nut
1-7/16"-20 Hex Nut
11-7/16"-20 x 1.5" Studs.
11-7/16"-20 Locking Nuts
12-7/16" Flat Washers
11-10mm Flat Head Bolts

For Wire Loom Bracket:

1-1/4" x 1" Bolt
1-1/4" Flat Washer
1-1/4" Nylock Nut

For Correction Mount:

2-7/16" x 1" Bolts
2-7/16" Flat Washers
2-7/16" Top Lock nuts

For Transmission Skid:

2-3/8" x 1" Bolts
2-3/8" Flat Washers
2-3/8" Flange Lock Nuts



By purchasing any item sold by Rough Country, LLC, the buyer expressly warrants that he/she is in compliance with all applicable , State, and Local laws and regulations regarding the purchase, ownership, and use of the item. It shall be the buyers responsibility to comply with all Federal, State and Local laws governing the sales of any items listed, illustrated or sold. The buyer expressly agrees to indemnify and hold harmless Rough Country, LLC for all claims resulting directly or indirectly from the purchase, ownership, or use of the items.



When it comes to quality performance suspension parts, Rough Country is the brand you can depend on.