

ROUGH COUNTRY

SUSPENSION SYSTEMS

14-18 2WD GM 1500 7" Kit for Aluminum and Stamped Steel LCA

Thank you for choosing Rough Country for your suspension needs. We appreciate your business!!

Rough Country recommends a certified technician install this system. In addition to these instructions, professional knowledge of disassemble/reassembly procedures as well as post installation checks must be known. Attempts to install this system without this knowledge and expertise may jeopardize the integrity and/or operating safety of the vehicle.

Please read instructions before beginning installation. Check the kit hardware. Be sure you have all needed parts and know where they go.

PRODUCT USE INFORMATION

▲WARNING The taller a vehicle is, the easier it will roll. Seat belts and shoulder harnesses should be worn at all times. Avoid situations where a side rollover may occur. Generally, braking performance and capability are decreased when larger/heavier tires and wheels are used. Take this into consideration while driving. Do not add, alter, or fabricate any factory or after-market parts to increase vehicle height over the intended height of the Rough Country product purchased. Mixing component brands is not recommended.

Rough Country makes no claims regarding lifting devices and excludes any and all implied claims. We will not be responsible for any product that is altered. We will be happy to answer any questions concerning the design, function, and correct use of our products.

▲WARNING Trucks equipped with electric power steering must unplug the steering components before any parts are removed. Failure to do so may cause damage to the rack and pinion.

This kit is packaged as a leveling kit—raising the front 7" and the rear 6". If you desire a different look or if the vehicle has a tool box or added weight in the rear, please consult with your sales representative about an add-a-leaf option.

▲NOTICE Due to differences in manufacturing, dimension and inflated measurements, tire and wheel combinations should be test fit prior to installation. For this application we recommend a 18" or larger wheel not to exceed 9" in width. When using a 18" wheel backspacing should be maximum of 5.5" and a minimum 5.0". With a 20" or larger wheel backspacing should be a maximum of 6.0" and a min of 5.5". Additionally a quality tire of radial design is recommended, not exceeding 35" tall and 12.5" wide. Please note that use of a 35" x 12.5" tire may require modification to the front valance.

▲WARNING Please refer to the instructions on the last page for trimming the tie rods. For alignment purposes, it will be necessary to trim/shorten the tie rod end to allow the front end alignment to be set properly.

Optional kicker Bars Part #1262 are available for this kit. Please contact you local Rough Country Dealer for information.

▲NOTICE DEALER AND VEHICLE OWNER

Any vehicle equipped with any Rough Country product should have a "Warning to Driver" decal installed on the inside of the windshield or on the vehicle's dash. The decal should act as a constant reminder for whoever is operating the vehicle of its unique handling characteristics.

INSTALLING DEALER - it is your responsibility to install the warning decal and forward these installation instructions on to the vehicle owner for review. These instructions should be kept in the vehicle for its service life.



KIT COMPONENTS



This kit is packaged in 4 boxes. Please confirm that you have all the needed parts and know where they go prior to beginning installation.

1229Box1

Front Cross Member
Rear Cross Member

1237N2

Sway Bar Bracket (2)
Fr Brake Line Bracket (2)
Rear Brake Line Bracket
Rear Shock (2)
Hardware Bag

For Front Cross Member

5/8" x 4 1/2" Bolt (2)
5/8" Lock Nuts (2)
5/8" Washers (4)

For Rear Cross Member

5/8" X 5 1/2" Bolt (2)
5/8" Lock Nuts (2)
5/8" Washers (4)

For Lwr Strut to Ctrl Arm Mt

10mm x 55mm Bolt (4)
10mm Lock Nuts (4)
10mm Washers (8)

For Sway Bar Bracket

10mm x 35mm Bolt (4)
10mm Lock Nuts (4)
10mm Lock Washer (4)
10mm Washers (8)

For Frt and Rr Brake Line Brkts

5/16" x 3/4" Bolt (4)
5/16" Nylon Lock Nut (4)
5/16" Washer (8)
Shock Bushing Bag
Bushings (4)
Shock Sleeve (4)

1237Box3

Rear Block (2)
9/16" x 2.5" x 13.5" Sq U-Blt (4)
9/16 U-Bolt Bag
9/16" Lock Nut (8)
9/16" Washer (8)
Block Hardware Bag
7/16" x 3" x 3" Sq U-Bolt (4)
7/16" Lock Nut (8)
7/16" Washer (8)
Front Strut Spacer (2)
Pre Load Spacers (2)
Strut Spacer Hardware Bag
3/8" x 1.25" Self Clinch Blt (6)
3/8" Nut (6)
3/8" Lock Washer (6)
Transmission Shims (2)
1296BAG3
Sway Bar Link (2)

1264Box3 (07-13), 1238Box1 (14-15 Aluminum), or 1237box1 (14-15 Steel)

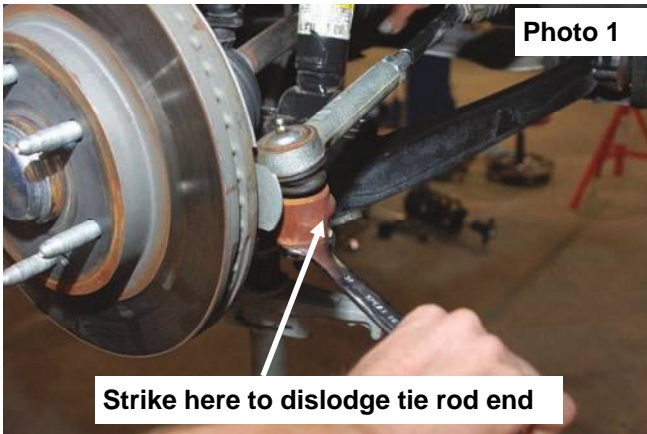
Dr Knuckle
Pass Knuckle

Tools Needed:

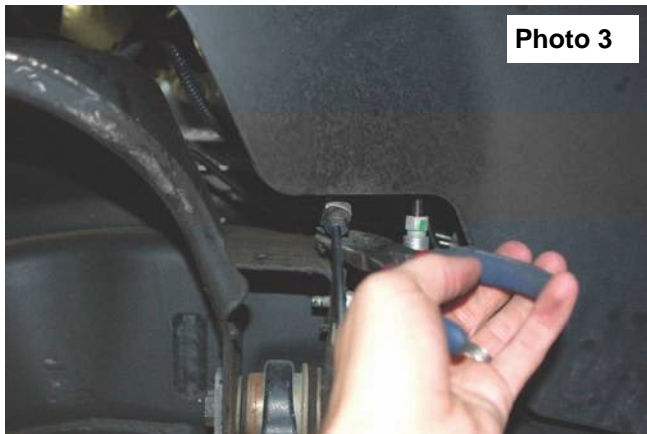
Floor Jack / Jack Stands
8mm Allen Socket
10mm Socket / Wrench
11mm Socket / Wrench
13mm Socket / Wrench
15mm Socket / Wrench
17mm Socket / Wrench
18mm Socket / Wrench
21mm Socket / Wrench
22mm Socket / Wrench
24mm Socket / Wrench
19mm Socket / Wrench
35mm Socket
9/16" Socket / Wrench
Torsion Bar Tool
Reciprocating Saw
Drill
11/16" Drill Bit
Hand Grinder
Loctite

FRONT INSTALLATION

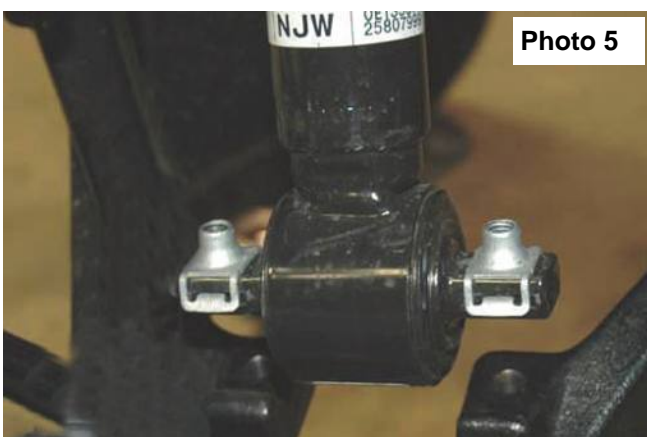
1. Park the vehicle on a level surface and chock the rear wheels.
2. Jack up the front of the vehicle. Place jack stands under the frame rails and lower onto jack stands letting the front suspension hang.
3. Remove the tires and wheels. Remove the upper and lower factory skid plates using a 15mm wrench. Retain factory hardware and front skid plate for reuse. Unplug the electric power steering if equipped.
4. Using a 21mm wrench, remove the tie-rod nut as shown in **Photo 1**. Strike the side of the mount to dislodge the tie rod end. Remove from the knuckle.
5. Remove the sensor wire from the plastic clip. Remove the bracket from the control arm using a 10mm wrench. **See Photo 2.**



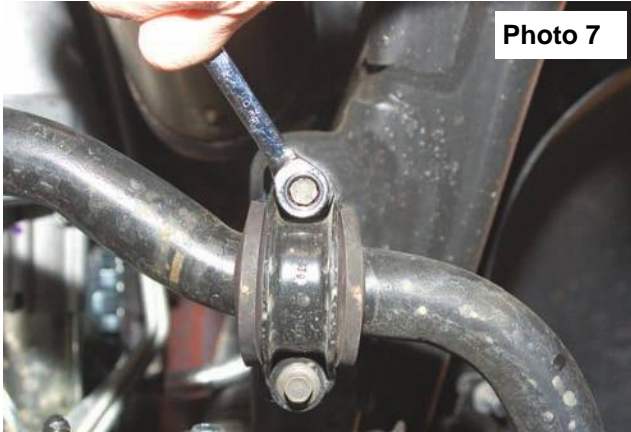
6. Remove and unplug the ABS sensor wire from the frame as shown in **Photo 3** and remove the two bolts holding brake caliper to the factory knuckle using a 18mm wrench. Remove the caliper assembly from the knuckle and hang securely out of the way. **⚠️ WARNING** Do not hang the caliper by the brake hose.
7. Using a 18mm wrench, remove the upper strut nuts as shown in **Photo 4**. Retain factory hardware for reuse.



8. Using a 15mm wrench, remove the 2 bolts securing the lower strut as shown in **Photo 5**, to the lower control arm and remove the strut from the vehicle. Remove and discard the factory lower retainer clips. New hardware will be used.
9. Remove the sway bar & end links from the lower control arm as shown in **Photo 7** using a 15mm wrench.



10. Remove the sway bar from the frame as shown in **Photo 7** using a 10mm wrench. Retain all hardware for reuse.
11. Using a 15mm wrench, remove the 6 axle shaft bolts from the differential and remove from the knuckle. Repeat on opposite side.
12. Remove the upper and lower ball joint from knuckle using a 18mm wrench and 24mm on the lower. Upper shown in **Photo 8**. Strike the knuckle as shown to dislodge the ball joint. Separate the upper control and lower control arm from the knuckle and remove the knuckle and the lower control arms from the vehicle.



13. Mark location of alignment cams on upper control arms to allow reinstallation of stock arm to the same position. Using a 21mm wrench and 21mm socket, remove the upper control arms from the vehicle. **See Photo 9**. Retain the hardware for reuse.



14. Remove the four rear cross member bolts and remove the rear cross member brace as shown in **Photo 10** using a 18mm wrench.
15. Install the front cross member as shown in **Photo 11** with the supplied 5/8" x 4 1/2" bolts, nuts /washers. Do not tighten at this time.



Photo 10

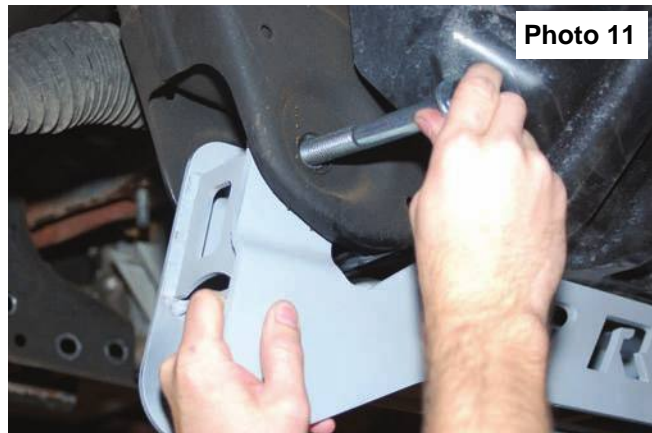


Photo 11

16. Install the rear cross member in the factory location using the supplied 5/8" x 5 1/2" bolts, nuts/ washers as shown in **Photo 12**.
17. Reinstall the lower control arms in the cross member brackets with the factory hardware. Do not tighten at this time.
18. Using a 17mm wrench and the supplied sleeve and nut, press in the 10mm studs into the strut spacer. **See Photo 13**.



Photo 12



Photo 13

19. Using a strut compressor, disassemble the strut and place the preload spacer between the coil isolator and the lower coil seat. Reassemble strut using a strut compressor. **See Photo 14**.
20. Install the strut spacer on top of the strut as shown in **Photo 15** with the stock hardware. Tighten using a 18mm wrench.
21. Install the strut in the upper strut tower using the supplied 10mm nuts, washers & lock washers. Tighten using a 18mm wrench.
22. Install the lower part of the strut in the factory location on the lower control arm with the supplied 10mm x 55mm bolts, nuts /washers. Tighten using a 17mm wrench.

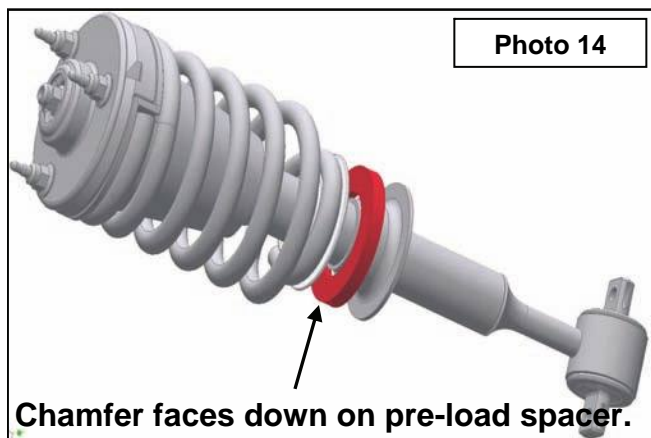


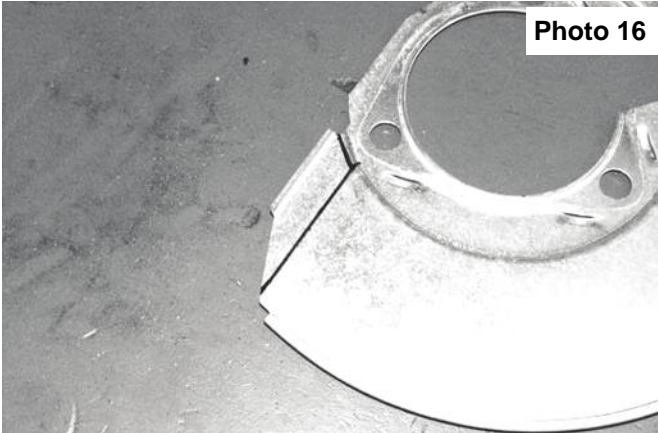
Photo 14

Chamfer faces down on pre-load spacer.

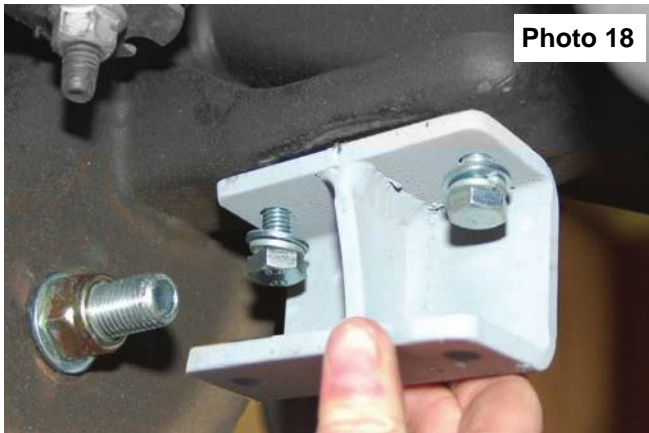


Photo 15

23. The brake shroud must be trimmed to allow the caliper to be reinstalled, Mark the dust shroud as shown in **Photo 15** and trim. Reinstall the brake caliper on the knuckle with the factory hardware and tighten.
24. On the factory knuckles, remove the bearing assembly using a 15mm wrench and install in the new knuckle. Tighten hardware. **See Photo 16.**



25. Install the knuckles on the lower ball joint with the factory hardware. Tighten using a 18mm wrench.
26. Trim tie rod ends as per instructions on last page and install on the knuckle. Tighten using a 21mm wrench.
27. Install the sway bar drop brackets with the 10mm x 35mm bolts, lock washers, and flat washers using a 17mm wrench. Tighten hardware. **See Photo 17.**
28. Install the sway bar on the sway bar drop brackets with the stock bolts and supplied 10mm nuts & washers. Tighten using a 17mm wrench. **See Photo 18.**



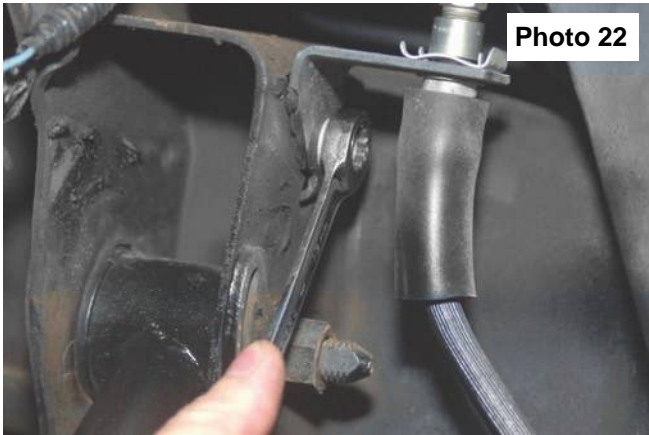
29. **Stamped Steel Lower Control Arms skip to step 30.** Using the supplied template on last page of instructions as a guide, mark and drill the lower control arm using a 11/16" drill bit to relocate the sway bar end link. **See Photo 19.** After drilling, install the sway bar end link with the stock hardware and tighten.
30. Install the supplied sway bar link using the supplied nuts. **Do Not use an Impact!!!** Torque to 90ft-lbs using a 19mm wrench and 21mm socket. **Do Not use an Impact!!! See photo 21.**



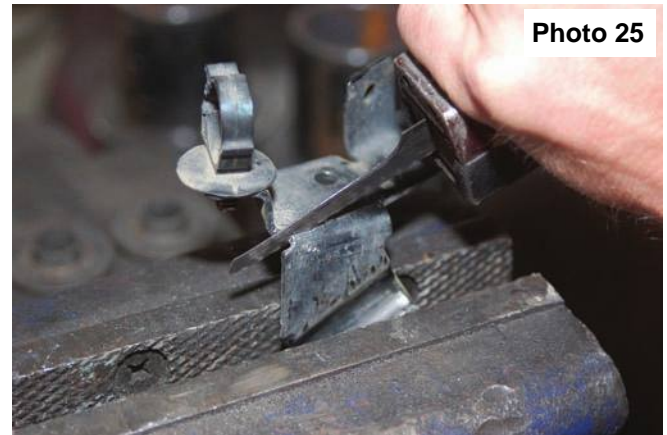
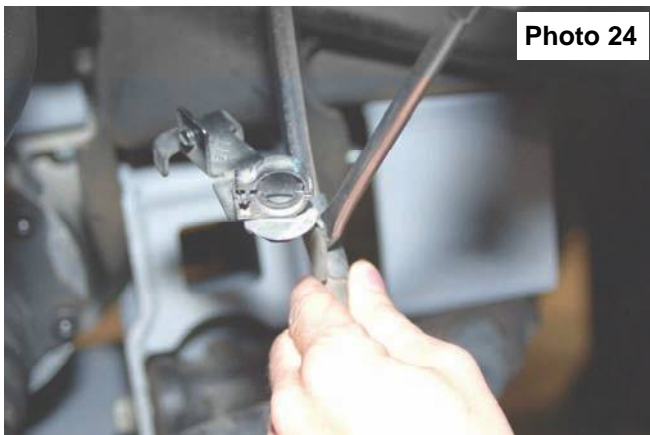
DRIVER SIDE SHOWN

Install sway bar links.

31. Remove the brake line bracket from the upper control arm mount as shown in **Photo 22** using a 13mm wrench.
32. Install the supplied brake line relocation bracket on the upper control arm mount with the stock hardware. Slightly pull down on the brake line assembly and reinstall on the drop bracket with the supplied 5/16" x 3/4" bolts, nuts /washers using a 7/16 wrench. **See Photo 23**. Reconnect the ABS wire that was disconnected in Step 6.



33. Remove the ABS wire from the brake line clip and remove the brake line from the bracket using a flat head screw driver as shown in **Photo 24** and trim as shown in **Photo 25**. Reinstall the modified bracket on the stock control arm with the stock hardware and reinstall the ABS wire in the clip.
34. If the optional kicker bars were purchased with this kit, install at this time per the instructions included with that kit.
35. Plug in the connector to the electric power steering if equipped. Reinstall the factory upper skid plate with the factory hardware.
36. Install the tires and wheels. Jack up the front of the vehicle and remove the jack stands.
37. Lower the vehicle to the ground.



REAR INSTALLATION INSTRUCTIONS

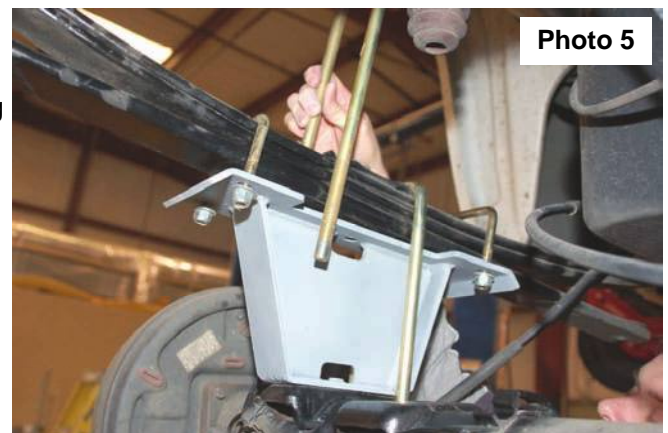
1. Chock the front tires.
2. Before jacking up the rear of the vehicle. Remove the stock brake line bracket using a 13mm wrench, from the driver side frame rail to allow the extension bracket to be installed. Also remove the clip securing the hard line and wiring harness to the top of the frame. **See Photo 1**. The stock bolts can be accessed from the side of the vehicle. Retain the stock hardware for reuse.
3. Install the brake line bracket to the new bracket with the supplied 5/16" x 3/4" bolts, nuts /washers. Reinstall the assembly in the stock location with the stock hardware using a 13mm wrench. **See Photo 2**.



4. Remove the e-brake cable from the mount as shown in **Photo 3**. This will require a screw driver to bend open mounting loop.
5. Remove the ABS wire, if equipped, from the frame rail as shown in **Photo 4** to allow slack in the line.



6. Jack up the rear of the vehicle and place jack stands under the frame rails. Remove tire and wheels.
 7. Lightly support the differential with a floor jack .
 8. Remove the stock shock absorbers using a 21mm wrench. Retain the hardware for reuse.
 9. Remove the stock u-bolts and lower the axle to allow the supplied block to be installed. Discard the factory block if so equipped.
 10. Install the new block with the supplied 7/16" X 3" u-bolts on the leaf spring. Do not tighten at this time. Jack up the axle to meet the new block and make sure the center pin is in the axle. Tighten 7/16" u-bolts. **See Photo 5**.
- ▲ NOTICE** The short side of block goes towards front of vehicle.
11. Install the supplied u-bolts and tighten using a 22mm wrench and a crossing pattern. **See Photo 5**.
 12. Insert bushings into RCX 2.2 series shock eye, then install sleeve into bushings. The use of dish soap to lubricate bushing makes this process easier.
 13. Install the shock absorbers in the factory location tighten using a 21mm wrench. **▲ NOTICE** 2.2 upgrade shocks are designed to run shock body up. N2.0 shocks are designed to run shock body down.
 14. Using WD-40 lubricate the ABS wire and slide the rubber sleeve up to allow the wire to be reinstalled in the clip on the frame. The connector will not be reattached to the top of the frame. Reroute the lines as needed to gain sufficient slack.



15. **07-13 models skip to step 18.**

16. Using a 15mm socket remove the 2 bolts from the transmission crossmember and jack up the transmission.. **See Photo 8.**

17. Install the (2) transmission shims along with the bolts and washers from 1296BAG3. **See Photo 9.**



18. Let the transmission down and tighten the hardware using a 16mm socket. Torque to 32 ft-lbs.

19. Re-install tires and wheels.

20. Remove jack stands and lower vehicle to ground.

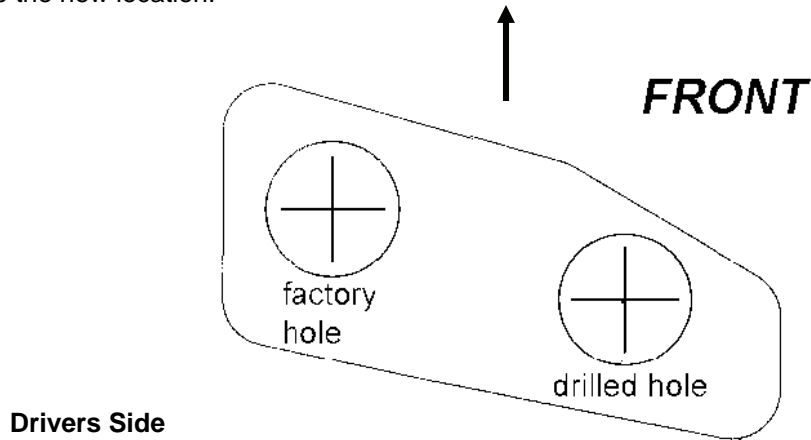
21. Place shock decals on shock absorbers and window decal on vehicle.

By purchasing any item sold by Rough Country, LLC, the buyer expressly warrants that he/she is in compliance with all applicable , State, and Local laws and regulations regarding the purchase, ownership, and use of the item. It shall be the buyers responsibility to comply with all Federal, State and Local laws governing the sales of any items listed, illustrated or sold. The buyer expressly agrees to indemnify and hold harmless Rough Country, LLC for all claims resulting directly or indirectly from the purchase, ownership, or use of the items.



TEMPLATE FOR SWAY BAR RELOCATION

Cut out template and position template on lower control arm as shown in Step 45.. Drill with a 11/16 drill bit and relocate the sway bar end links into the new location.



INSTRUCTIONS FOR TRIMMING TIE ROD ENDS.

1. Disassemble the tie rod from the tie rod ends
2. Measure over 3/8" and mark.
3. Cut the tie rods / tie rod sleeves as shown below to allow the vehicle to be realigned.
4. Smooth any rough edges.
5. Reassemble the cut assembly



POST INSTALLATION INSTRUCTIONS

1. Check all fasteners for proper torque. Check to ensure for adequate clearance between all rotating, mobile, fixed, and heated members. Verify clearance between exhaust and brake lines, fuel lines, fuel tank, floor boards and wiring harness. Check steering gear for clearance. Test and inspect brake system.
2. Perform steering sweep to ensure front brake hoses have adequate slack and do not contact any rotating, mobile or heated members. Inspect rear brake hoses at full extension for adequate slack. Failure to perform hose check/ replacement may result in component failure.
3. On some vehicles the front lower skirting will need to be trimmed if using certain wheel /tire combinations and with heavy offset wheels. Trim only as needed.
4. Activate four wheel drive system and check front hubs for engagement.
5. Have a qualified alignment center align the vehicle immediately. Realign to factory specifications. The following are the recommended specifications:

Caster in degrees	4.5 +-1.0
Camber in degrees	0.0—.3
Toe In in degrees	0.1 +- .2

⚠ WARNING For alignment purposes, please refer to the instructions above. The inner & outer tie rod ends may need to be trimmed to allow the front end alignment to be set properly. Please alert your alignment specialist of this possibility.

6. Perform head light check and adjustment to proper settings.
7. Check and retighten wheels at 50 miles and again at 500 miles.
8. All kit components must be retightened at 500 miles and then every three thousand miles after installation. Periodically check all hardware for tightness.
9. Install "Warning to Driver" decal on sun visor

Note: Installation of larger tires will require speedometer recalibration.

Thank you for choosing Rough Country for all of your suspension needs.



When it comes to quality performance suspension parts, Rough Country is the brand you can depend on.