

# ROUGH COUNTRY

## SUSPENSION SYSTEMS®

### 2007-15 4WD GM Tahoe, Yukon and Suburban 1500 3.5" LIFT KIT– Steel Knuckles

Thank you for choosing Rough Country for your suspension needs.

Rough Country recommends a certified technician install this system. In addition to these instructions, professional knowledge of disassemble/reassembly procedures as well as post installation checks must be known. Attempts to install this system without this knowledge and expertise may jeopardize the integrity and/or operating safety of the vehicle.

Please read instructions before beginning installation. Check the kit hardware against the parts list on the rear cover of these instructions. Be sure you have all needed parts and know where they go. Also please review tools needed list and make sure you have needed tools.

#### PRODUCT USE INFORMATION

**⚠ WARNING** As a general rule, the taller a vehicle is, the easier it will roll. Seat belts and shoulder harnesses should be worn at all times. Avoid situations where a side rollover may occur. Generally, braking performance and capability are decreased when larger/heavier tires and wheels are used. Take this into consideration while driving. Do not add, alter, or fabricate any factory or after-market parts to increase vehicle height over the intended height of the Rough Country product purchased. Mixing component brands is not recommended.

Rough Country makes no claims regarding lifting devices and excludes any and all implied claims. We will not be responsible for any product that is altered. If question exist we will be happy to answer any questions concerning the design, function, and correct use of our products.

**⚠ NOTICE** This kit will not fit trucks with aluminum knuckles.

The electric power steering must be unplugged before any of the steering components are removed. Failure to do so may cause damage to the electric power steering.

Vehicles with a mass damper on the front diff, the damper will have to be removed.

This kit is packaged as a leveling kit—raising the front 3.5" and the back 1.75". If you desire a different look or if the vehicle has a tool box or added weight in the rear, please consult with your sales representative about other coil spring spacer options.

This suspension system was developed using a 32 x 11.5 tire with factory wheels. Examples of tire sizes that we suggest are 285/65R18, 285/55R20, or 285/45R22. **Note** if wider tires are used, offset wheels will be required and trimming may be required.

#### ⚠ NOTICE NOTICE TO DEALER AND VEHICLE OWNER

Any vehicle equipped with any Rough Country product should have a "Warning to Driver" decal installed on the inside of the windshield or on the vehicle's dash. The decal should act as a constant reminder for whoever is operating the vehicle.

#### Tools Needed:

18MM Wrench  
15MM Wrench  
21MM Wrench  
11MM Wrench  
10MM Wrench  
Floor Jack  
Jack stands  
Strut Compressor  
Die Grinder

#### Torque Specs:

Size	Grade 5	Grade 8	Grade 10
5/16"	15 ft/lbs	20 ft/lbs	25 ft/lbs
3/8"	30 ft/lbs	35 ft/lbs	45 ft/lbs
7/16"	45 ft/lbs	60 ft/lbs	75 ft/lbs
1/2"	65 ft/lbs	90 ft/lbs	110 ft/lbs
9/16"	95 ft/lbs	130 ft/lbs	165 ft/lbs
5/8"	135 ft/lbs	175 ft/lbs	210 ft/lbs
3/4"	185 ft/lbs	280 ft/lbs	350 ft/lbs
	Class 8.8	Class 10.9	
6MM	5 ft/lbs	9 ft/lbs	
8MM	18ft/lbs	23 ft/lbs	
10MM	32ft/lbs	45ft/lbs	
12MM	50ft/lbs	75ft/lbs	
14MM	85ft/lbs	120ft/lbs	
16MM	130ft/lbs	165ft/lbs	
18MM	170ft/lbs	240ft/lbs	

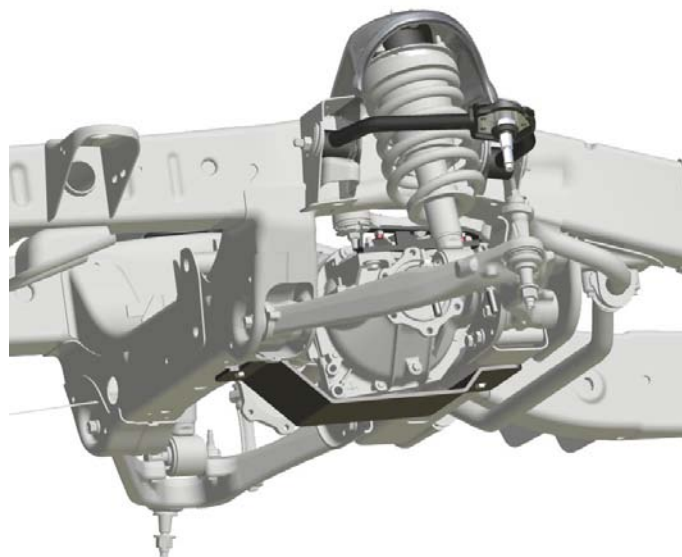

## FRONT INSTALLATION

1. Park the vehicle on a level surface and chock the rear wheels.
2. Jack up the front of the vehicle. Place jack stands under the frame rails and lower onto jack stands letting the front suspension hang.
3. Remove the tires and wheels. Remove the 6 bolts holding the factory skid plate using a 15mm socket. Unplug the three connectors going to the electric power steering. **See Photo 1.**
4. Retain factory hardware and front skid plate for reuse.
5. Using a 21mm wrench, remove the tie-rod nut as shown in **Photo 2**. Strike the front of the mount to dislodge the tie rod end. Remove from the knuckle.

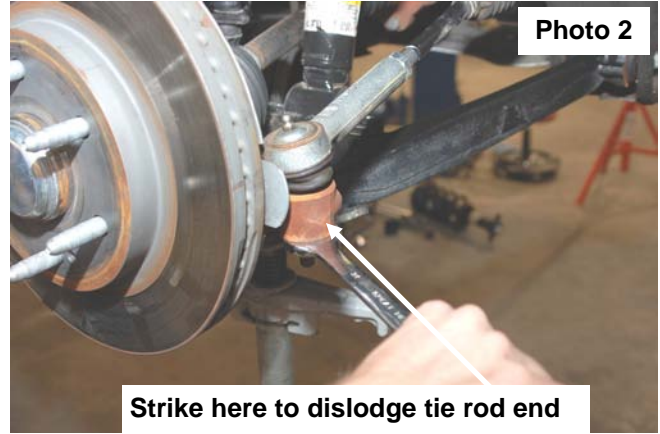
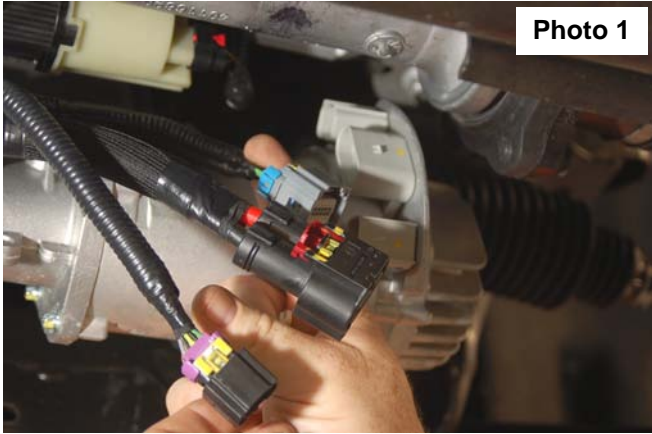

6. Remove the sensor wire from the plastic clip. Remove the brake line bracket from the control arm using a 10mm wrench. **See Photo 3.**
7. Remove and unplug the ABS sensor wire from the frame as shown in **Photo 4**.

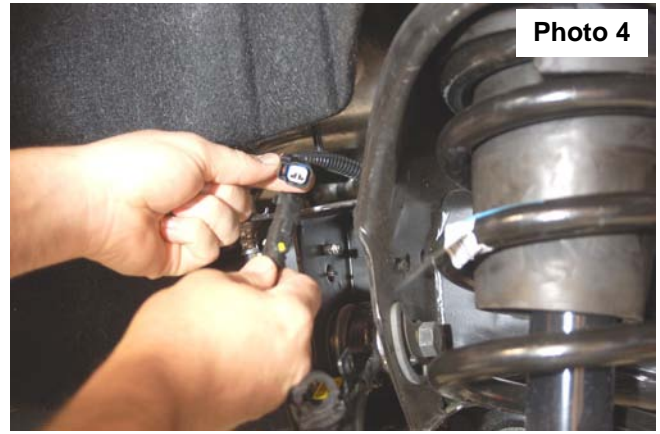

8. Remove sway bar link with 15mm socket and wrench. Place jack stand under knuckle for support and then remove upper ball joint nut using a 18mm wrench. **See Photo 5.** Strike the knuckle as shown to dislodge the ball joint. Separate the upper control arm from the knuckle.
9. Using a 18mm wrench, remove the upper strut nuts as shown in **Photo 6**. Retain factory hardware for reuse.

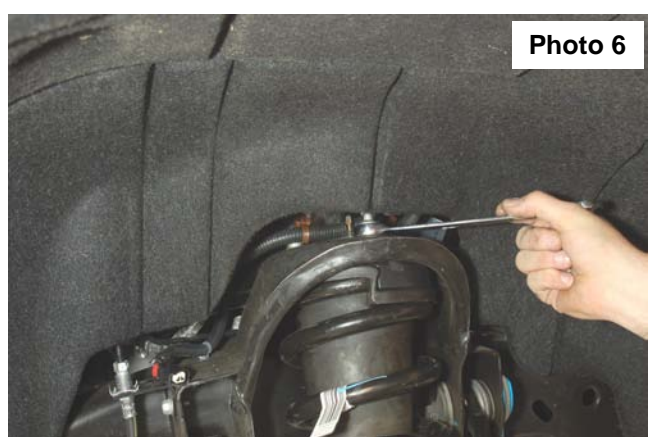

10. Using a 15mm wrench, remove the 2 bolts securing the lower strut mount to the lower control arm and remove the strut from the vehicle. **See Photo 7.**
11. Mark location of alignment cams on upper control arms to allow installation of new arm to same position. Using a 21mm wrench and 21mm socket, remove the upper control arms from the vehicle. **See Photo 8.** Retain the hardware.

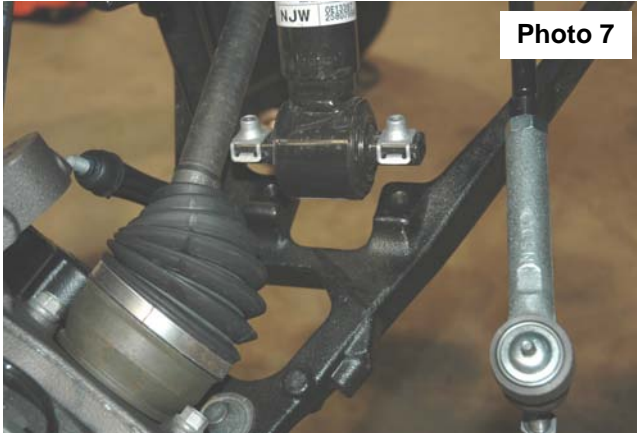
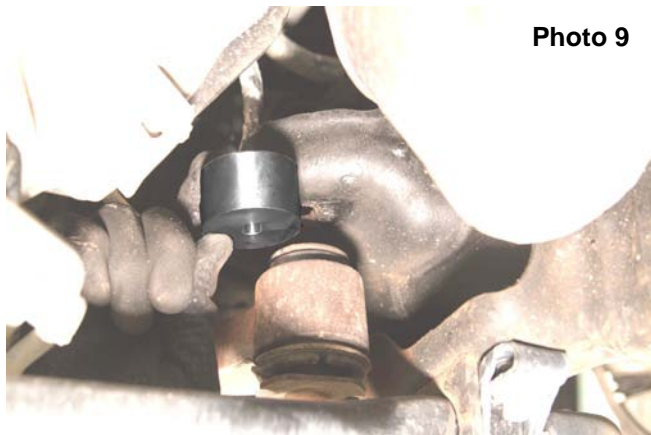

**Photo 7**

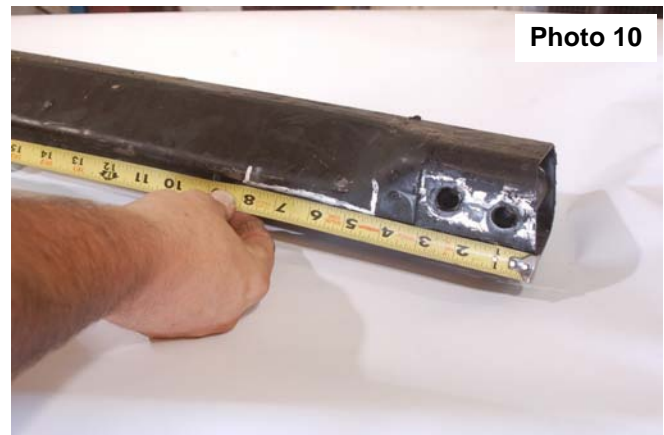

**Photo 8**

12. Using a 18mm socket and wrench remove the four bolts holding in the factory cross member. Retain factory hardware.
13. Use a jack stand to support the front diff. Remove the 4 bolts holding the diff mounts to the frame with a 15mm and 18mm wrench.
14. Lower the jack stand and pull down on the front of the diff to allow enough room to slide the two 1" diff drop spacers into place. Use the supplied 7/16" x 4.5" bolts, lock washers, and nuts from 275BAG6. Repeat this process to install 1" spacers in the rear diff mounts, as well. Tighten using 16mm and 18mm socket and wrench. Tighten with a 16mm and 18mm socket and wrench. **See Photo 9.**
15. On the driver side of the factory cross member measure from the end of the tube and make marks at 4.5" and 8" on the front side as shown in **Photo 10.** Measure 1/4" for the bottom, and 2" from the back side and mark.



**Photo 9**

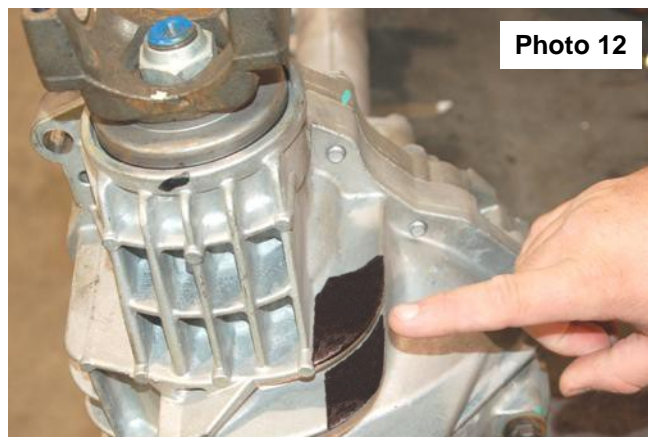

**Photo 10**

16. Using a die grinder and cut across the marks as shown in **Photo 11.**
17. Using a die grinder, grind the cooling fins on the diff. Hold the cross member into place and check clearance between the cross member and front diff. **See Photo 12.**

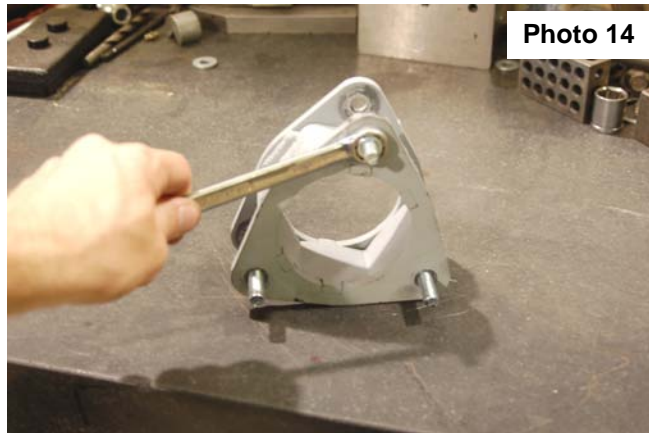

**Photo 11**

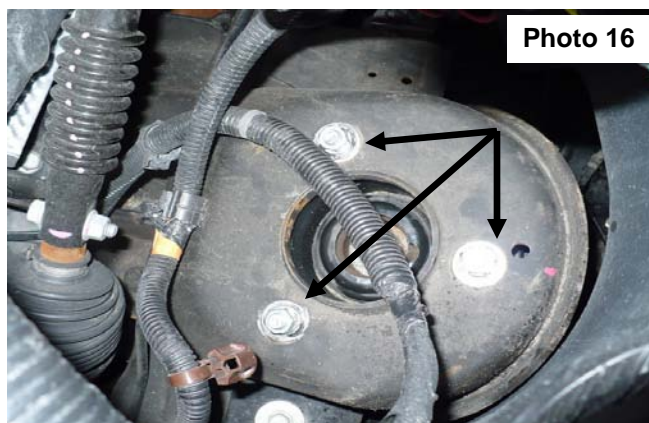
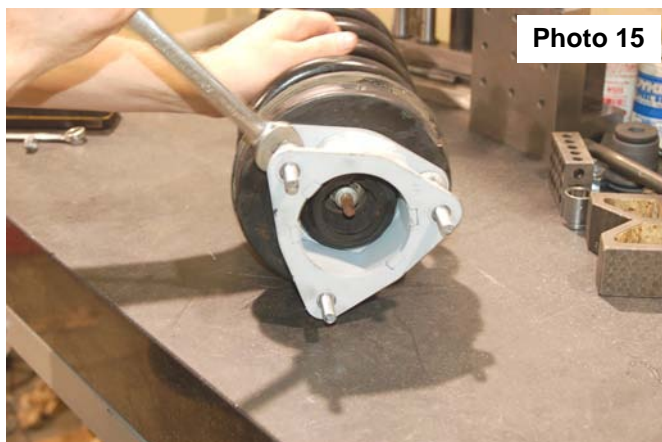

**Photo 12**

18. Insert factory hardware into the stock cross member and tighten with a 18mm socket and wrench. **See Photo 13.**
19. Using the supplied 10mm studs place each stud into the smaller sized holes in the strut spacer facing upward. Use the supplied sleeve to slide over each stud to act as a spacer allowing you to pull the stud through the hole with the 10mm nut and a 17mm wrench, locking the stud into place. Remove sleeve and repeat on the other five studs. **See Photo 14.**



20. Place the strut spacer on top of the stud and tighten using factory hardware and a 18mm wrench. **See Photo 15.**
21. Install the strut assembly in the factory mount with the supplied 10mm nuts/washers & lock-washers on the upper mount. Tighten using a 17mm wrench. **Note: Locking washer must be installed between nut and regular washer on studs. See Photo 16.**



22. Install the strut in the lower control arm using supplied 3/8" x 2.25" bolts, washers, and nuts. **See Photo 17.** It may be necessary to jack up the lower control arm with a floor jack to align lower strut holes.
23. Reinstall the sway bar on the lower control arm using a 15mm wrench.



**Photo 17**

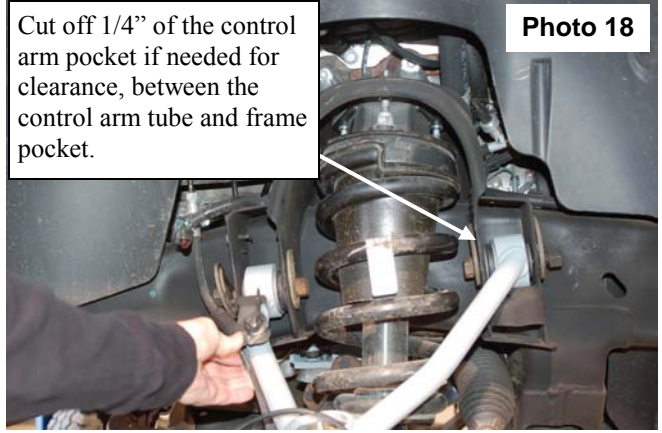

Cut off 1/4" of the control arm pocket if needed for clearance, between the control arm tube and frame pocket.

**Photo 18**

24. Install the supplied control arm with factory hardware. Reinstall the knuckle to the upper control arm with the supplied castle nuts/cotter pins. Tighten using 3/4" wrench to **50 ft/lbs. DO NOT OVER-TORQUE THE CASTLE NUT.** Reinstall the tie rod end into the knuckle with factory hardware and using a 21mm wrench.
25. Install the brake line bracket on the new control arm with the supplied 1/4" lock nut / washer and using a 7/16" wrench. **See Photo 18. Driver side shown.**
26. Reconnect the ABS wire that was disconnected.
27. Locate and install the new lower skid plate below the differential in the factory location with the factor hardware and using a 15mm wrench. **See Photo 19.**
28. Reconnect the three connectors going to the electric power steering.
29. Reinstall the wheels/tires.
30. Jack up the vehicle and remove the jack stands.
31. Lower the vehicle to the ground.



**Photo 19**

## REAR INSTALLATION

1. Chock the front wheels.
2. Place a floor jack under the differential and jack up the rear of the vehicle.
3. Place jack stands under the frame rails and lower onto the jack stands.
4. Remove the tires/wheels.
5. Locate and remove the ABS wire from the frame. **See Photo 1.**
6. Remove the upper and lower shock from the axle using a 21mm socket/ wrench. **See Photo 2.**

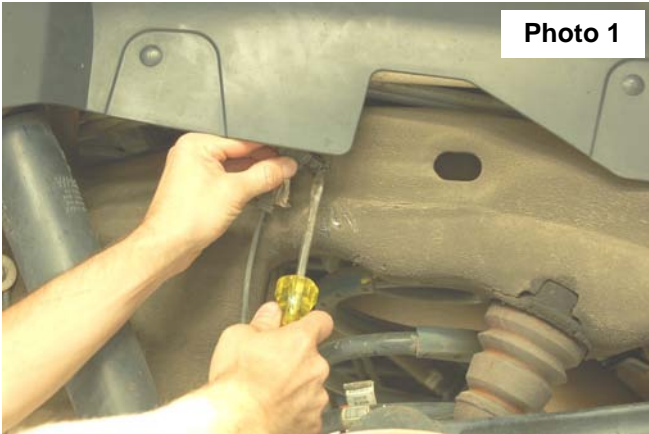

Photo 1



Photo 2

7. Remove the upper sway bar link using a 18mm socket/ wrench. **See Photo 3.**
8. Remove the e-brake mount using a 13mm socket / wrench. **See Photo 4.**



Photo 3

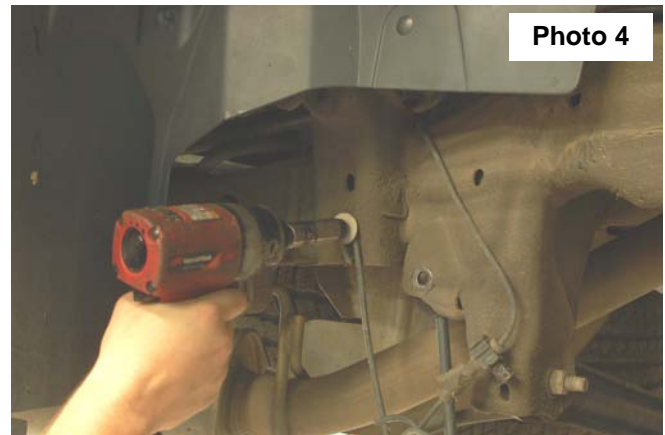

Photo 4

9. Remove the brake line with a 13mm wrench. **See Photo 5.**
10. Remove the coil.
11. Install the spring spacer washer on top of the mount as shown in **Photo 6.**



Photo 5



Photo 6

12. Secure the spacer in the mount and washer using the supplied 3/8" x 3 3/4" bolts and lock nuts. **See Photo 7.**
13. Reinstall the coil spring making sure the coil isolator is between the coil and new spacer.
14. Install the brake line spacer as shown in **Photo 8** with the supplied 8mm x 65mm bolt and locking nut. Tighten with a 13mm socket/ wrench.

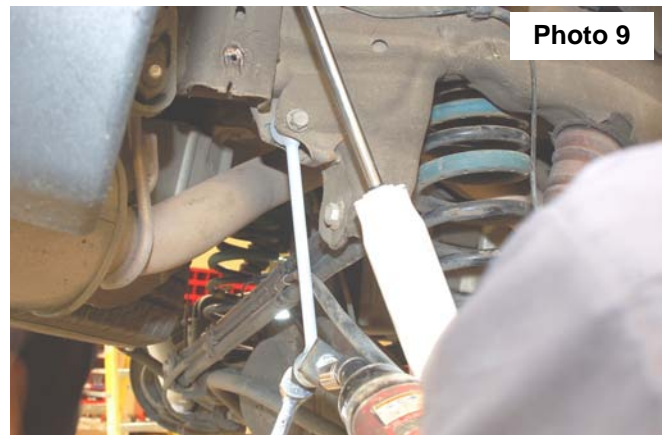

**Photo 7**



**Photo 8**

15. Install the supplied sleeves in the sway bar link and install on the frame using the stock hardware.
16. Place the supplied washer on the head of the supplied 12mm x 65mm bolt and install on the sway bar with the nut on the sway bar as shown in **Photo 9** using. Tighten using a 18mm & 19mm wrench.
17. Install the shock relocation bracket as shown in the factory shock location with the supplied 5/8" x 1 1/2" bolt, washers and lock nut on the bottom of the shock mount. **See Photo 10.**
18. Install the supplied 14mm x 75mm bolt, washers and lock nuts in the stock shock mount. **See Photo 11.**
19. Install the tires/wheels.
20. Jack up the vehicle to remove the jack stands. Remove the jack stands and lower the vehicle to the ground.



**Photo 9**



**Photo 10**

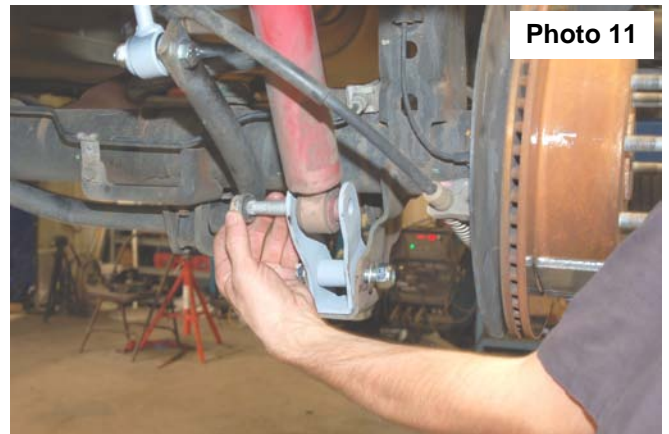

**Photo 11**

**Alignment Specs:**

		←	Optimal	→
<b>Total Toe</b>	Deg.	-0.10°	+0.10°	+0.30°
<b>Frnt. Toe Partial</b>	Deg.	-0.05°	+0.05°	+0.15°
<b>Front Camber</b>	Deg.	-0.90°	-0.10°	+0.70°
<b>Caster</b>	Deg.	+1.90°	+2.90°	+3.90°

## KIT CONTENT



### 193.20 Box Kit

- 1-Driver Side Control Arm
- 1-Pass Side Control Arm
- 1-Driver Side Diff Bracket
- 1-Pass Side Diff Bracket
- 1-Diff Lower Skid Plate
- 1-Diff Skid Plate
- 2-Strut Spacers
- 2-Rear Shock Relocation Brackets
- 2-Rear Sway Bar Links
- 2-Rear Coil Spacers
- 4-Diff Spacers

### 1-Front Kit Bag:

- For Lower Strut:*
- 4-3/8" x 2 1/4" bolts
- 8-3/8" washers
- 4-3/8" lock nuts
- For Upper Control Arms:*
- 2-1/4" nut
- 2-1/4" Flat Washers
- For Front Strut Spacers:*
- 6-10mm Studs
- 6-10mm Lock Washers
- 6-10mm Flat Washers
- 6-10mm Nuts
- For Differential:*
- 4-7/16" x 4.5" Bolts
- 4-7/16" Lock Washers
- 4-7/16" Nuts
- 2-1/4" Nylocks
- 4- 7/16" Flat Washers
- For Skid Plate:*
- 2-3/8 self tapping bolts

### 1-Rear Kit Bag:

- For Rear Coil Spacer:*
- 2-3/8" x 3 3/4" Bolts
- 2-3/8" Flange Locknut
- For Rear Brake Line:*
- 1-Sleeve
- 1-8mm x 60mm Bolt
- For Rear Sway Bar Link:*
- 2-12mm x 65mm Bolt
- 2-12mm Flange Lock Nuts
- 2-Flat Washers
- 4-12mm ID Sleeves
- For Rear Shock Relocation Brckts*
- 2-14mm x 75mm Bolts
- 2-14mm Lock Nuts
- 2-Flat Washers
- 2-5/8" x 1 1/2' Bolts
- 4-5/8" Flat Washers
- 2-5/8" Lock Nuts

Thank you for choosing Rough Country for your suspension needs.

By purchasing any item sold by Rough Country, LLC, the buyer expressly warrants that he/she is in compliance with all applicable, State, and Local laws and regulations regarding the purchase, ownership, and use of the item. It shall be the buyers responsibility to comply with all Federal, State and Local laws governing the sales of any items listed, illustrated or sold. The buyer expressly agrees to indemnify and hold harmless Rough Country, LLC for all claims resulting directly or indirectly from the purchase, ownership, or use of the items.



Check out the collection of performance suspension parts we offer.