



GM 2014-18 4WD 1500 7" Knuckle Kit

Thank you for choosing Rough Country for your suspension needs.

Rough Country recommends a certified technician install this system. In addition to these instructions, professional knowledge of disassemble/reassembly procedures as well as post installation checks must be known. Attempts to install this system without this knowledge and expertise may jeopardize the integrity and/or operating safety of the vehicle.

Please read instructions before beginning installation. Check the kit hardware against the parts list on the rear cover of these instructions. Be sure you have all needed parts and know where they go. Also please review tools needed list and make sure you have needed tools.

PRODUCT USE INFORMATION

▲ WARNING As a general rule, the taller a vehicle is, the easier it will roll. Seat belts and shoulder harnesses should be worn at all times. Avoid situations where a side rollover may occur. Generally, braking performance and capability are decreased when larger/heavier tires and wheels are used. Take this into consideration while driving. Do not add, alter, or fabricate any factory or after-market parts to increase vehicle height over the intended height of the Rough Country product purchased. Mixing component brands is not recommended.

Rough Country makes no claims regarding lifting devices and excludes any and all implied claims. We will not be responsible for any product that is altered. If question exist we will be happy to answer any questions concerning the design, function, and correct use of our products.

▲ NOTICE The electric power steering must be unplugged before any of the steering components are removed. Failure to do so may cause damage to the electric power steering.

▲ NOTICE Trucks equipped with a mass damper on the front diff, the damper will have to be removed.

This kit is packaged as a leveling kit—raising the front 7" and the back 5.75". If you desire a different look or if the vehicle has a tool box or added weight in the rear, please consult with your sales representative about other block and u-bolt options.

This suspension system was developed using a 35" x 12.5" tire with 20" x 9" wheel and a offset of -12mm to +12mm. If wider tires are used trimming may be required. If stock 20" wheels are used, tires no wider than 11.5" wide are recommended. 20 x 9 wheels with +18mm offset will require 1/4" wheel spacers.

▲ NOTICE DEALER AND VEHICLE OWNER

Any vehicle equipped with any Rough Country product should have a "Warning to Driver" decal installed on the inside of the windshield or on the vehicle's dash. The decal should act as a constant reminder for whoever is operating the vehicle.

Tools Needed:

24mm socket /wrench	Floor Jack /Jack Stands	19mm socket /wrench
8mm Allen Socket	35mm socket	
10mm socket /wrench	1/2" socket/wrench	
11mm socket /wrench	9/16" socket /wrench	
13 mm socket/wrench	#30 Torx bit	
15mm socket / wrench	Reciprocating Saw	
17mm socket/wrench	Drill	
18mm socket /wrench	9/16" Drill Bit	
21mm socket /wrench	Hand Grinder	
22mm socket /wrench	Strut Compressor	

Torque Specs:

Size	Grade 5	Grade 8	Size	Class 8.8	Class 10.9
5/16"	15 ft/lbs	20 ft/lbs	6MM	5 ft/lbs	9 ft/lbs
3/8"	30 ft/lbs	35 ft/lbs	8MM	18ft/lbs	23 ft/lbs
7/16"	45 ft/lbs	60 ft/lbs	10MM	32ft/lbs	45ft/lbs
1/2"	65 ft/lbs	90 ft/lbs	12MM	55ft/lbs	75ft/lbs
9/16"	95 ft/lbs	130 ft/lbs	14MM	85ft/lbs	120ft/lbs
5/8"	135 ft/lbs	175 ft/lbs	16MM	130ft/lbs	165ft/lbs
3/4"	185 ft/lbs	280 ft/lbs	18MM	170ft/lbs	240ft/lbs

Kit Boxes

Stamped Steel & Aluminum LCA Models

17431 (6" Kit w/ N3 Rr Shocks):

174BOX1
174BOX2
17430BOX2
17430BOX11
17430BOX12

17432 (6" Kit w/ N3 Struts & N3 Rr Shocks):

174BOX1
17430BOX2
17430BOX11
17430BOX12
23023
20159 x 2

17450 (6" Kit w/ Fr & RR Vertex Shocks):

174BOX1
17430BOX2
17430BOX11
17430BOX12
680001-2 x 2
690001 x 2

17470 (6" Kit w/ V2 Rr Shocks):

174BOX1
174BOX3
17430BOX2
17430BOX11
17430BOX12
760748

17471 (6" Kit w/ N3 Struts & V2 Rr Shocks):

174BOX1
17430BOX2
17430box11
17430box12
23023
760748

17457 (6" Kit w/ Vertex Coil overs & V2 Rr Shocks):

174BOX1
17430BOX2
17430box11
17430box12
680001-2 x 2
760748

Cast Steel LCA Models

22832 (6" Kit w/ N3 Rr Shocks):

174BOX1
174BOX2
17430BOX2
1237BOX5

22832 (6" Kit w/ N3 Struts & N3 Rr Shocks):

174BOX1
17430BOX2
1237BOX5
23023
20159 x 2

22851 (6" Kit w/ Fr & RR Vertex Shocks):

174BOX1
17430BOX2
1237BOX5
680001-2 x 2
690001 x 2

22870 (6" Kit w/ V2 Rr Shocks):

174BOX1
174BOX3
17430BOX2
1237BOX5
760748

22871 (6" Kit w/ N3 Struts & V2 Rr Shocks):

174BOX1
17430BOX2
1237BOX5
23023
760748

22857 (6" Kit w/ Vertex Coil overs & V2 Rr Shocks):

174BOX1
17430BOX2
1237BOX5
680001-2 x 2
760748



17431, 17432, 17450, 17470, 17471, & 17457 Kit Box & Bag Contents

Box Kit

174BOX1 or 17450BOX1

Dr Diff Drop Bracket-1
Pass Diff Drop Bracket-1
Front Diff Mount-1
Center Diff Bracket-1
Sway Bar Drop Brackets-2
Sway Links-2
Tie Rod Ends-2
CV Spacers-2
U-Bolts-4
Rear Blocks-2
Lower Skid Plate-1
E-Brake Bracket-1
Front Brake Brackets-2
Rear Brake Line Bracket-1
174INSTRBAG
1229BAG2
1272BAG3
1229BAG3
1290BAG6
1263BAG2
9/16BAG

17430BOX2

Front Crossmember-1
Rear Crossmember-1

174BOX3

10MMSTUDBAG-1-1
Strut Spacers-2

17430BOX11

Driver Knuckle-1

17430BOX12

Passenger Knuckle-1

20159-Rear N3 Shock

23023-N3 Strut

760748-Rear V2 Shock

680001-2-Vertex Coilover

690001-Rear Vertex Shock

Kit Bags

174INSTRBAG

Instruction Sheet-1
Warning to Driver Sticker-1

1290BAG6-Bag

10mm x 35mm Bolts-4
10mm Nylock Nuts-4
Flat Washers-4
5/16" x 1" Bolts-5
5/16" Toplock Nuts-5
5/16" Flat Washers-10

1229BAG2-Front Kit Bag

For Sway Bar Drop Brackets:

10mm x 35mm Bolts-4
10mm Nylock Nuts-4
3/8" Flat Washers-8

For Differential Drop Brackets:

14mm x 10mm Bolt-1
9/16" Flat Washers-4
14mm Nylock Nuts-2
14mm x 110mm Bolt-1
1/2" x 1.25" Bolts-2
1/2" Flat Washers-4
1/2" Nylock Nuts-2

For Skid Plates:

3/8" Flat Washers-12
3/8" x 1" Bolts-4
3/8" Lock Washers-8
3/8" x 3.75" Bolts-2
3/8" Nylock Nuts-2

For Front Differential:

3/16" Vent Hose-1
3/16" Vent Tube Connector-1

1272BAG3-CV Spacer Bag

10mm x 65mm Socket Head Bolts

Kit Bags

1229BAG3-Crossmember Bag

9/16" x 4.5" Bolts-2
9/16" x 5.5" Bolts-2
Flat Washers-8
9/16" Nylock Nuts-4

10MMSTUDBAG-1-Upper Strut Spacer Bag

10mm Stud-6
10mm Lock Washer-6
10mm Nut-7
1/2" Jam Nut-1

9/16BAG-U-bolt Bag

9/16" Washers-8
9/16" Nuts-8

1263BAG2-Anti Wrap U-bolt Bag

7/16" x 3 1/8" x 3 1/4" Square U-bolt-4
7/16" Washer-8
7/16 Nylock-8



22832, 22833, 22851, 22870, 22871, & 22857 Kit Box & Bag Contents

Box Kit

Kit Bags

Kit Bags

174BOX1 or 122850BOX3

Dr Diff Drop Bracket-1
Pass Diff Drop Bracket-1
Front Diff Mount-1
Center Diff Bracket-1
Sway Bar Drop Brackets-2
Sway Links-2
Tie Rod Ends-2
CV Spacers-2
U-Bolts-4
Rear Blocks-2
Lower Skid Plate-1
E-Brake Bracket-1
Front Brake Brackets-2
Rear Brake Line Bracket-1
174INSTRBAG
1229BAG2
1272BAG3
1229BAG3
1290BAG6
1263BAG2
9/16BAG

17430BOX2

Front Crossmember-1
Rear Crossmember-1

174BOX2

10MMSTUDBAG-1-1
Strut Spacers-2
Rear N3 Shocks-2

174BOX3

10MMSTUDBAG-1-1
Strut Spacers-2

1237BOX5

Driver Knuckle-1
Passenger Knuckle-1

20159-Rear N3 Shock

23023-N3 Strut

760748-Rear V2 Shock

680001-2-Vertex Coilover

690001-Rear Vertex Shock

174INSTRBAG

Instruction Sheet-1
Warning to Driver Sticker-1

1290BAG6-Bag

10mm x 35mm Bolts-4
10mm Nylock Nuts-4
Flat Washers-4
5/16" x 1" Bolts-5
5/16" Toplock Nuts-5
5/16" Flat Washers-10

1229BAG2-Front Kit Bag

For Sway Bar Drop Brackets:

10mm x 35mm Bolts-4
10mm Nylock Nuts-4
3/8" Flat Washers-8

For Differential Drop Brackets:

14mm x 10mm Bolt-1
9/16" Flat Washers-4
14mm Nylock Nuts-2
14mm x 110mm Bolt-1
1/2" x 1.25" Bolts-2
1/2" Flat Washers-4
1/2" Nylock Nuts-2

For Skid Plates:

3/8" Flat Washers-12
3/8" x 1" Bolts-4
3/8" Lock Washers-8
3/8" x 3.75" Bolts-2
3/8" Nylock Nuts-2

For Front Differential:

3/16" Vent Hose-1
3/16" Vent Tube Connector-1

1272BAG3-CV Spacer Bag

10mm x 65mm Socket Head Bolts

1229BAG3-Crossmember Bag

9/16" x 4.5" Bolts-2
9/16" x 5.5" Bolts-2
Flat Washers-8
9/16" Nylock Nuts-4

10MMSTUDBAG-1-Upper Strut Spacer Bag

10mm Stud-6
10mm Lock Washer-6
10mm Nut-7
1/2" Jam Nut-1

9/16BAG-U-bolt Bag

9/16" Washers-8
9/16" Nuts-8

1263BAG2-Anti Wrap U-bolt Bag

7/16" x 3 1/8" x 3 1/4" Square U-bolt-4
7/16" Washer-8
7/16 Nylock-8



FRONT INSTALLATION

1. Park the vehicle on a level surface and chock the rear wheels. Raise the hood and disconnect the battery using a 10mm socket. Lock the steering wheel in the straight position.
2. Jack up the front of the vehicle. Place jack stands under the frame rails and lower onto jack stands letting the front suspension hang.
3. Remove the tires and wheels. Remove the 6 bolts holding the factory skid plate using a 15mm socket. Unplug the two connectors going to the electric power steering wiring harness behind the front skid plate. **See Photo 1.**
4. Remove and unplug the ABS sensor wire from the frame as shown in **Photo 2.**



5. Remove the sensor wire from the plastic clip. Remove the brake line bracket from the control arm using a 10mm wrench. **See Photo 3.** Next remove the bracket line bracket from the control arm pocket with a 13mm wrench.
6. Using a 21mm wrench, remove the tie-rod nut as shown in **Photo 4.** Strike the front of the mount to dislodge the tie rod end. Remove from the knuckle.



7. Remove the brake caliper using a 18mm socket. Hang the caliper out of the way and remove the rotor using a 30 torx socket. **See Photo 5.**
8. Use a 10mm socket to remove the ABS bracket from the top side of the knuckle.
9. Remove the dust cap and then remove the axle nut using a 35mm socket.

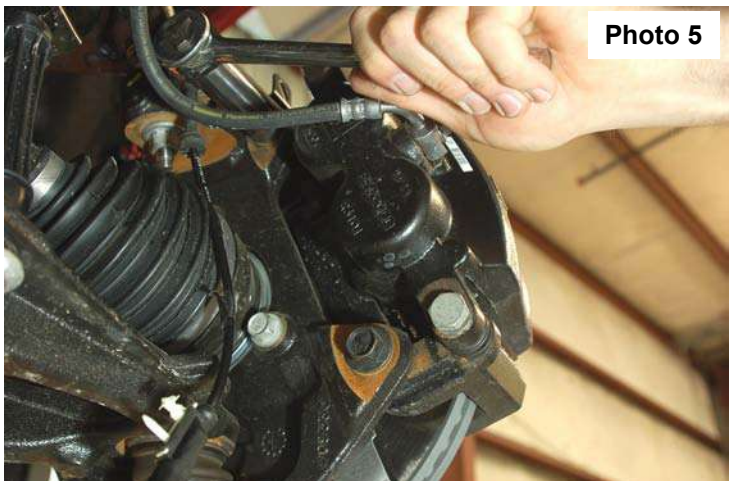

10. Remove the upper ball joint using a 18mm socket and separate using a hammer and striking the knuckle on the side as shown in **Photo 6**.
11. Remove the lower ball joint using a 24mm socket and separate with a hammer as shown in **Photo 7**. Next remove the knuckle from the truck.

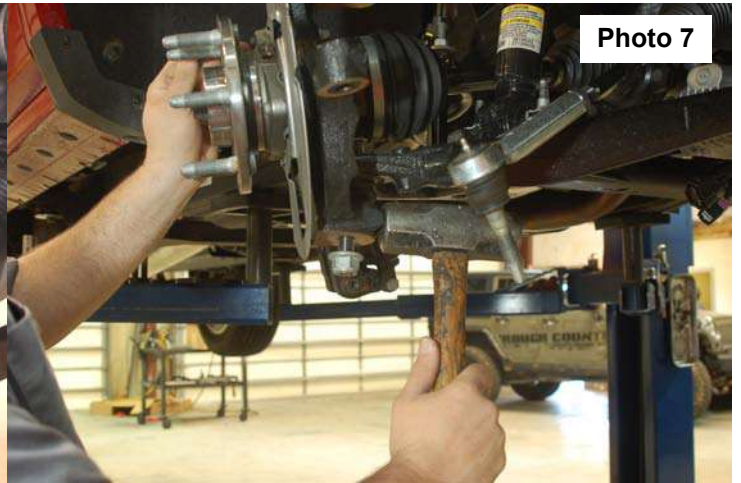

12. Using a 15mm wrench and socket remove the sway bar links from the truck. **See Photo 8**.
13. Remove the lower strut bolts using a 15mm socket as shown in **Photo 9** and remove the upper strut nuts using a 18mm wrench. Remove the strut from the truck.

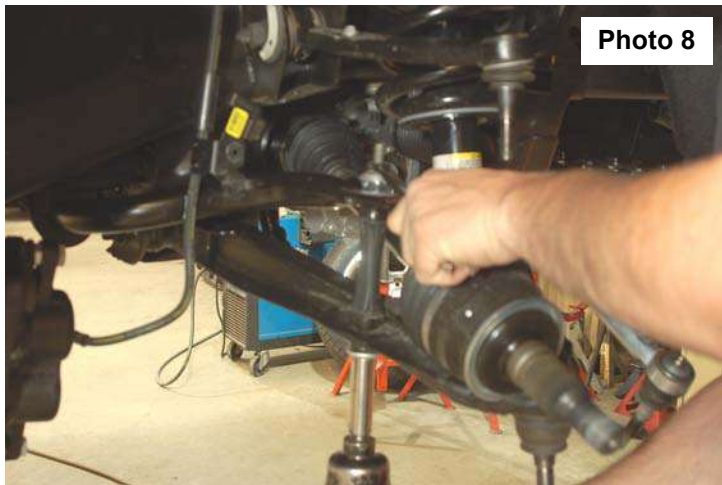

14. Remove CV axle bolts using a 15mm socket. **See Photo 10**.
15. Using a 10mm socket remove the sway bar from the bottom of the frame. **See Photo 11**.

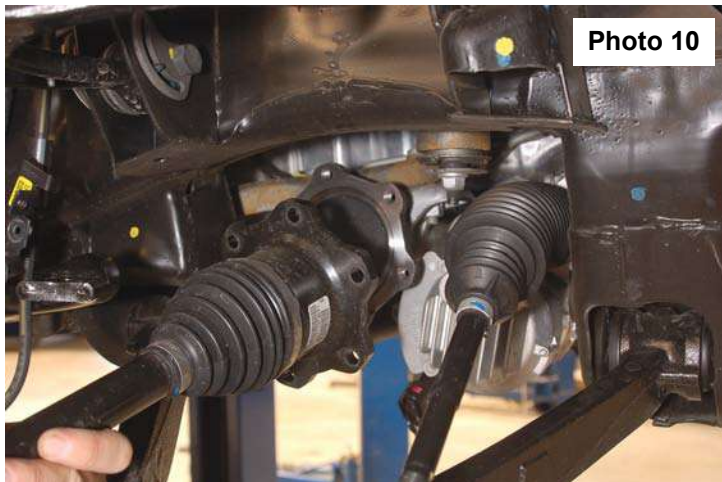

16. Remove the lower control arm using a 18mm wrench and a 24mm socket. **See Photo 12.**
17. Using a 18mm wrench and socket remove the factory lower rear cross-member. **See Photo 13.**

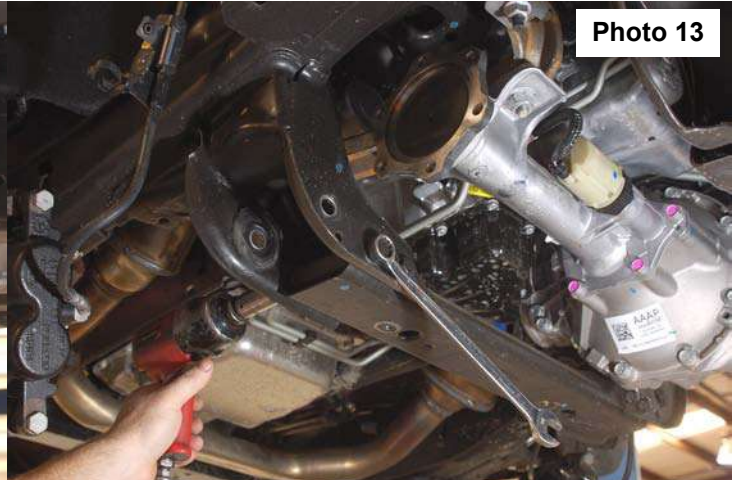
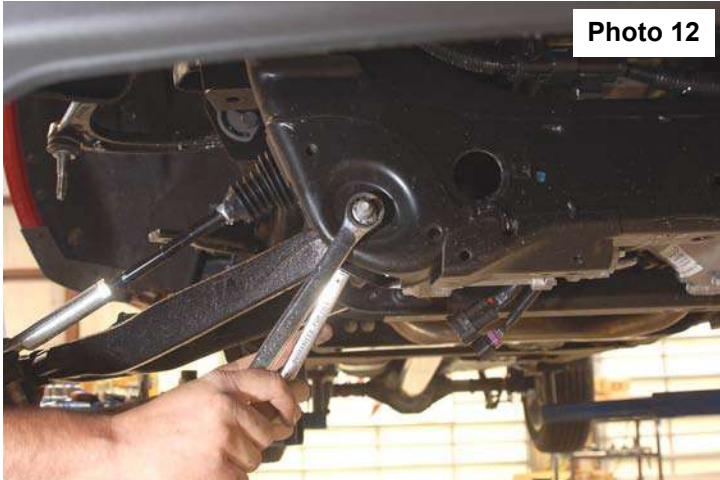

18. Using a 11mm socket remove the driveshaft from the front diff . **See Photo 14.** Unplug the actuator wire from diff, remove wire loom from diff, and remove vent tube from diff.
19. Make sure the steering wheel is straight, mark the steering shaft and pinion shaft as shown in **Photo 15.** Use a 11mm socket to remove the connecting bolt. With a jack support the rack and pinion, using a 24mm and 18mm socket remove the bolts from the rack and pinion mounts. Carefully lower the rack and pinion down making sure no wires are in harms way. Now you can remove the diff, use a 18mm and 21mm socket remove the bolts from diff. lower diff from truck.

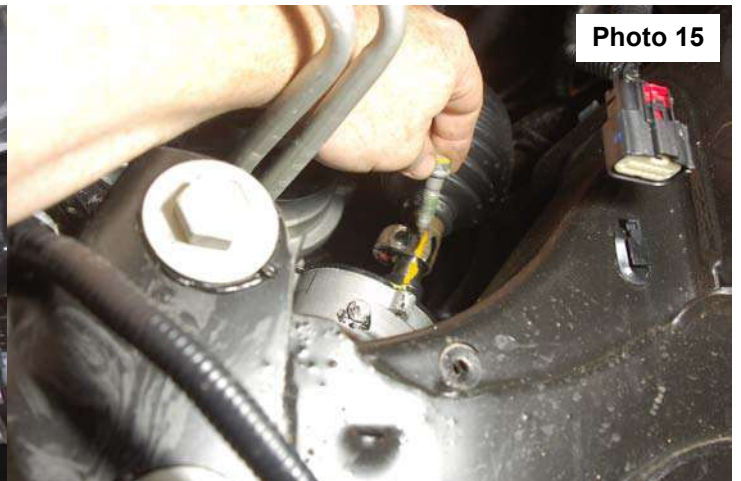

20. Mark the front and rear sides of the driver and passenger side rear control arm pocket, measure 3 3/8" from the end and cut off the factory crossmember mount. **See Photo 16 & 17.**

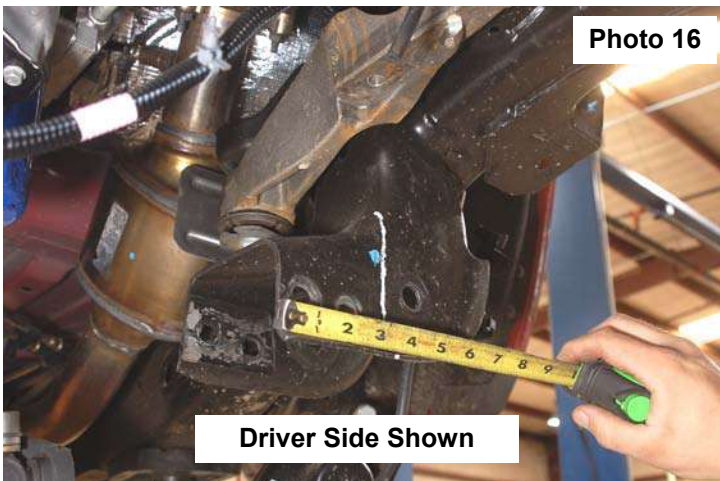

21. On the driver and passenger side rear control arm pocket cut the front lip off flush with the pocket 1.0" past the control arm hole . Sand edges and paint to prevent rust. **See Photo 18.**
22. On the passenger side of the diff cut the front ear off using a saw-zall or cut off wheel. Cut flush with the flat areas on the diff and grind smooth. **See Photo 19.**

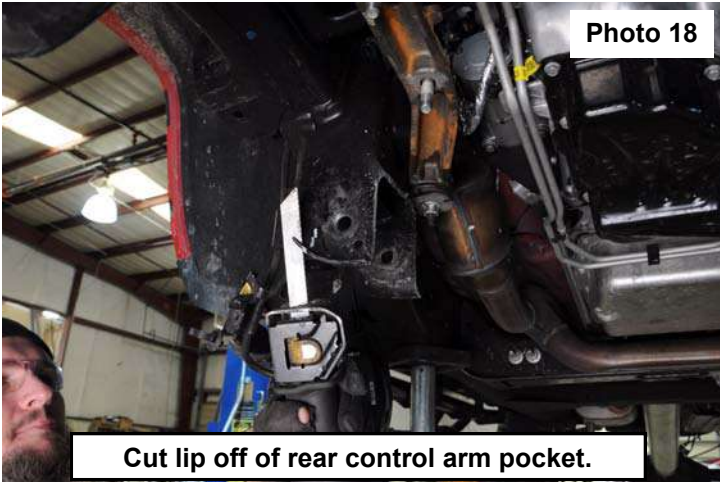

Photo 18

Cut lip off of rear control arm pocket.



Photo 19

Cut front ear off of differential.

23. Re-install the rack and pinion with factory hardware using a 24mm and 18mm sockets. Make sure to align the marks on the steering shaft. Install the passenger side diff drop bracket with the supplied 12mm flange locks on the factory studs. Tighten with a 18mm wrench. **See Photo 20. Torque all hardware to factory specs.**
24. Install the driver side diff drop bracket with the factory bolts and torque to factory specs with a 18mm socket. **See Photo 21.**

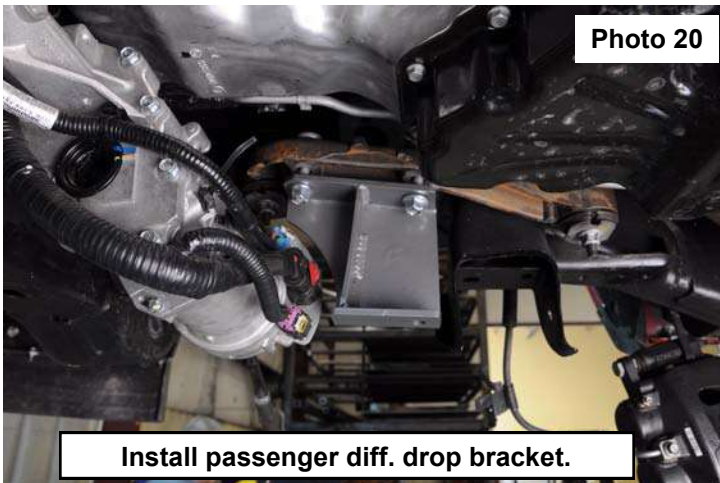

Photo 20

Install passenger diff. drop bracket.



Photo 21

Install driver diff. drop bracket.

25. Install the diff using the supplied 12mm bolts and flange nuts on the driver side and 12mm bolts with stock nuts on the passenger side. Do not tighten at this time.
26. Install front crossmember using new 5/8" x 4.5" bolts, washer, and nuts. Hand tighten. **See Photo 22.**
27. Install center diff drop mounting bracket using the supplied 1/2" x 1.0" bolts and nuts to the front crossmember. Tighten with a 3/4" socket and wrench. **See Photo 23. Torque to 90ft-lbs.**

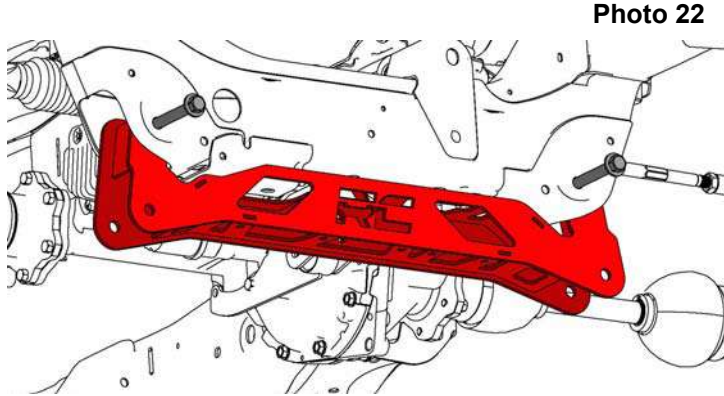

Photo 22

Install front crossmember.

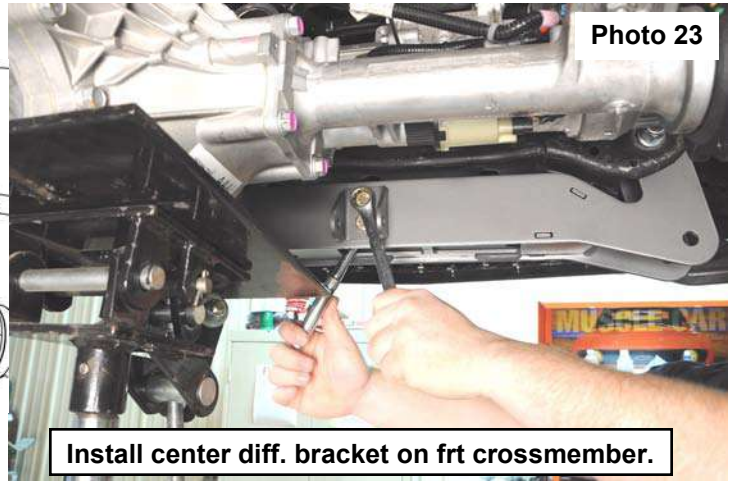

Photo 23

Install center diff. bracket on frt crossmember.

28. Remove the 3 bolts on the diff as shown in **Photo 24**. Next install the center diff bracket with the 3 factory bolts remove earlier and attach the bracket to the diff mount with the supplied 14mm x 85mm bolt, washers, and lock nut. Tighten using 18mm, 19mm, and 21mm socket and wrenches. **See Photo 24. Torque factory hardware to factory specs. Torque 14mm hardware to 85ft-lbs.**
29. After installing the diff, torque all diff bolts. **See Photo 25.** Make sure the diff on the passenger side clears the rack and pinion and no wires are pinched between the diff and the rack. Plug in the vent tube extension and the 4x4 actuator.

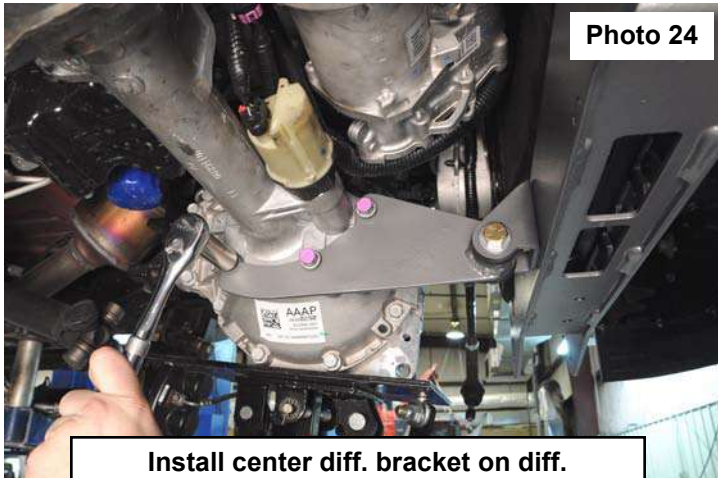

Photo 24

Install center diff. bracket on diff.

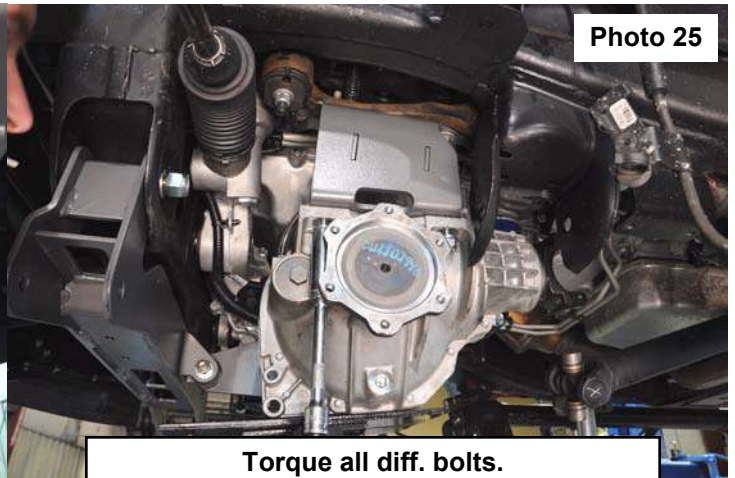

Photo 25

Torque all diff. bolts.

30. Install the driveshaft using stock hardware and a 11mm wrench to tighten. **See Photo 26. Torque to factory specs.**
31. Install the rear crossmember with the supplied 5/8" x 5.5" bolts. Hand tighten.
32. Install the factory lower control arm with stock hardware. Hand tighten. Now tighten the 5/8" bolts that secures the crossmembers to the frame with a 24mm wrench. **See Photo 27. Torque to 175ft-lbs.**



Photo 26

Install driveshaft.



Photo 27

Install lower control arm.

33. Install sway-bar drop bracket using 10mm x 35 mm bolts and washers. Tighten using 17mm wrench. **See Photo 28.** Install sway-bar using stock bolt with new 10mm nuts. **See Photo 29.** Use a 10mm socket and 17mm wrench to tighten. Install stock sway-bar link using a 15mm to tighten. **Torque to 35ft-lbs.**

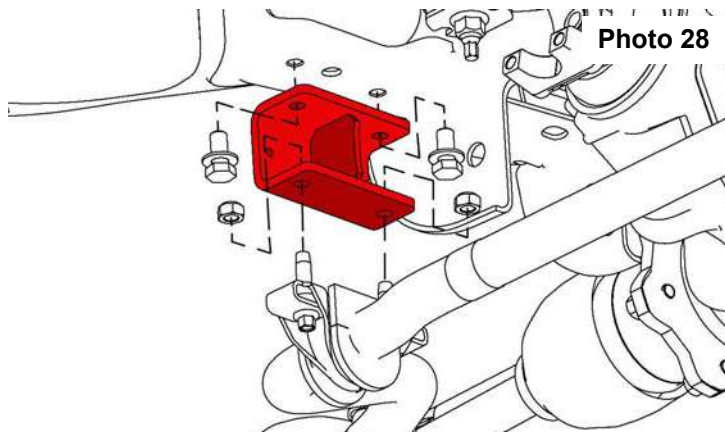

Photo 28

Install sway bar drop bracket.



Photo 29

Install sway bar.

34. Install the CV spacer as shown in **Photo 30** between the axle shaft and the differential. Secure with the supplied 10mm x 65mm allen head bolts with a 8mm allen socket to tighten. **Torque to 35ft-lbs.**
35. Install the supplied sway bar link using the supplied nuts. **Do Not use an Impact!!!** Torque to 90ft-lbs using a 19mm wrench and 21mm socket. **Do Not use an Impact!!! See photo 31.**

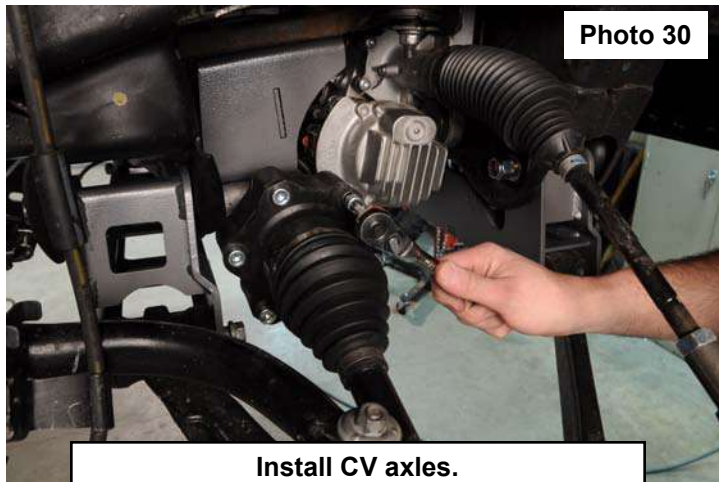

Photo 30

Install CV axles.

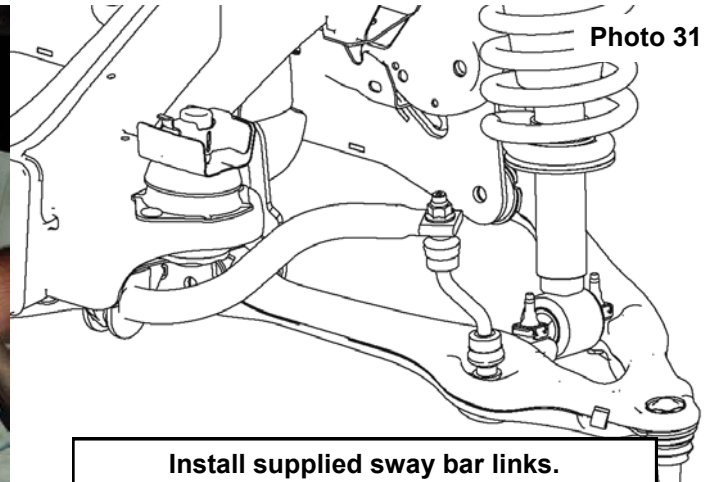

Photo 31

Install supplied sway bar links.

36. On the factory knuckles, remove the bearing assembly using a 15mm wrench. Next the brake shroud must be trimmed to allow the caliper to install on the new knuckle. Mark the dust shroud as shown in **Photo 32** and trim. Install the factory bearing and dust shroud into the new supplied knuckle. Tighten with a 15mm wrench. **See Photo 33. Torque to factory specs.**

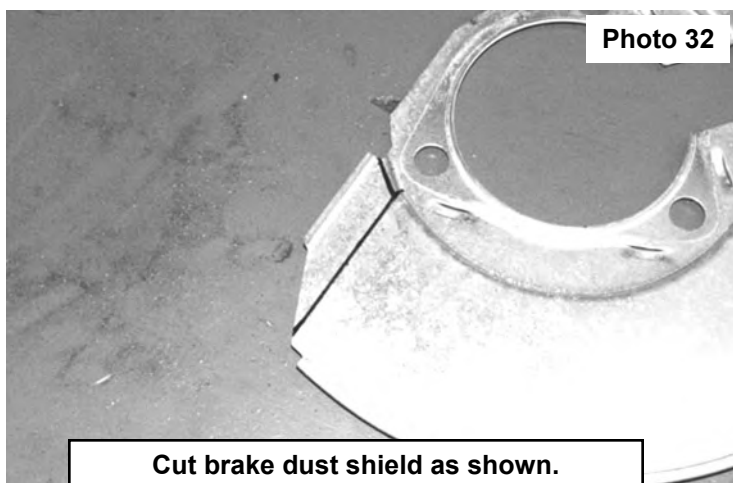

Photo 32

Cut brake dust shield as shown.

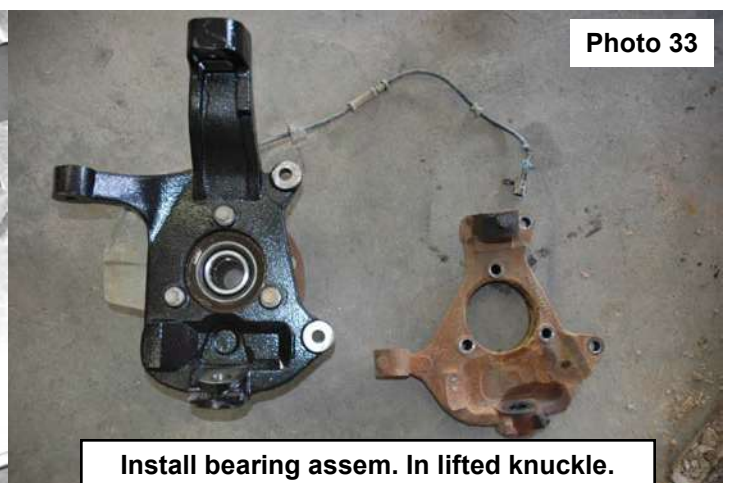
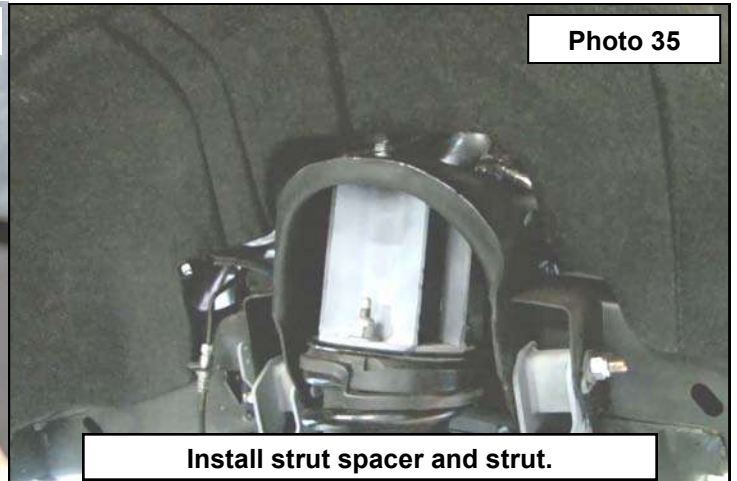
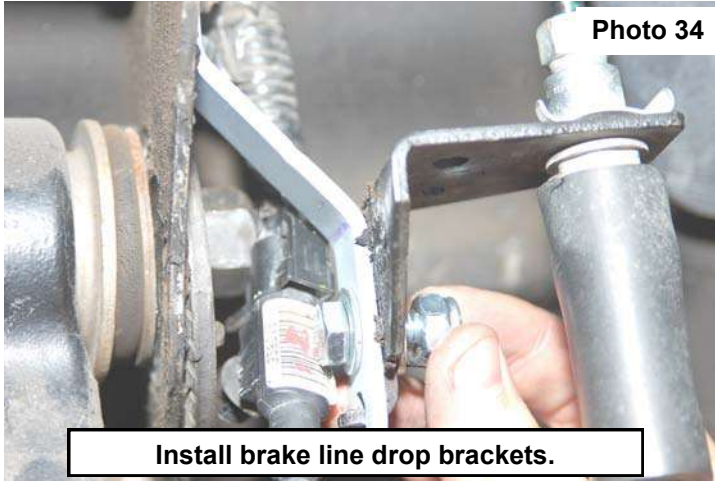

Photo 33

Install bearing assem. In lifted knuckle.

37. Install brake line drop bracket to the frame using stock hardware. Next secure factory brake line mount to the new drop bracket using the supplied 5/16" x 1" bolts, washers, and nuts. **See Photo 34.** Use a 13mm wrench and socket to tighten. **Torque to 35ft-lbs.**
38. **If installing the Rough Country lifted struts (23023) or Vertex coilovers (680001-2) refer to the instructions included with the strut and skip to step 42.**
39. Press in the 10mm studs into the strut spacer. Install strut spacer on to strut using stock hardware and a 18mm wrench to tighten.
40. Install strut into truck using the supplied 10mm nuts and lock washers. Use a 9/16" wrench to tighten. **See Photo 35.**



41. Use stock hardware for lower strut mount and use a 15mm wrench to tighten lower strut bolts. **Torque to factory specs.**
42. Remove the ABS wire from the brake line clip and remove the brake line from the bracket using a flat head screw driver and trim as shown in **Photo 36.** Reinstall the modified bracket on the stock control arm with the stock hardware and reinstall the ABS wire in the clip.
43. Install knuckles using stock hardware. **See Photo 37.** Use a 24mm for lower ball joint a 18mm for upper joint and a 35mm for axle nut. Install rotor and install bolt using a 30mm torx socket. Install the brake caliper using a 18mm socket for the bolts. **Torque to factory specs.**
44. Install the supplied tie rod ends on the tie rod and attach to the knuckle using the supplied hardware. Tighten using a 21mm wrench.
44. Install skid plates using supplied 3/8" x 1.25" bolts and washers. **See Photo 37.** Use a 14mm socket to tighten all bolts. **Torque to 35ft-lbs.**
45. Install the wheels and tires, then jack up the truck and remove the jack stands. Lower truck on ground tighten upper and lower control arm bolts using 21mm for upper and 18mm and 24mm socket and wrench for bottom. **Torque to factory specs.**

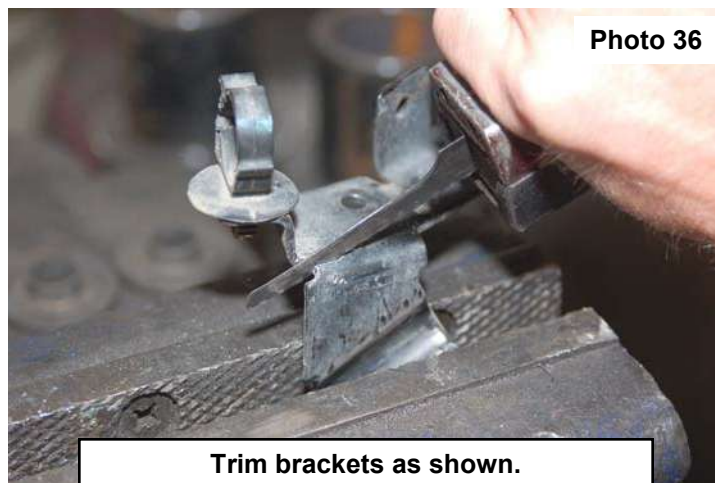

Due to tire manufacturer variances and/or other wheel and tire combinations, modification to the upper control arm may be necessary to prevent rubbing. Using a rotary sander, lightly sand the front lip of the factory upper control arm until there is no contact with the wheel and/or tire throughout the full turning radius. **See Photo 38.**

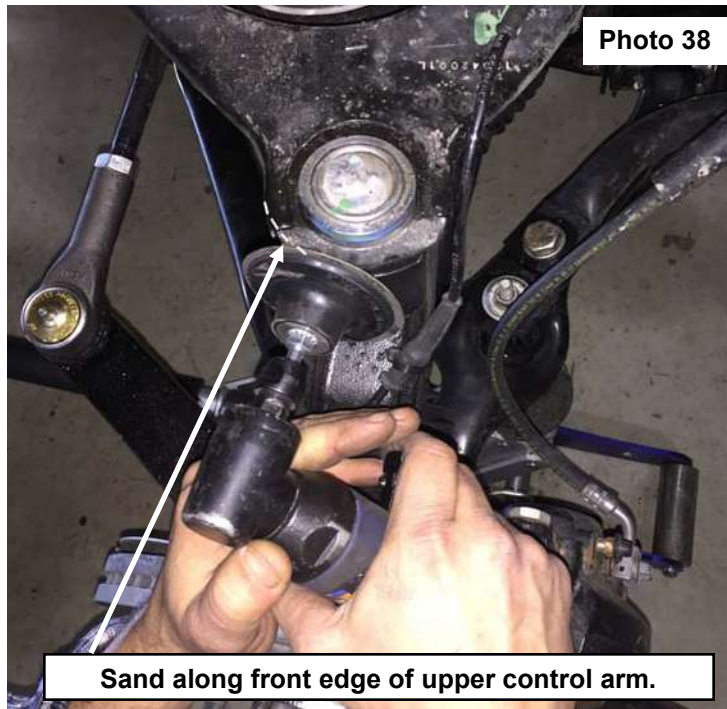

Sand along front edge of upper control arm.

REAR INSTALLATION

1. Chock the front tires.
2. Before jacking up the rear of the vehicle. Remove the stock brake line bracket using a 13mm wrench, from the driver side frame rail to allow the extension bracket to be installed. Also remove the clip securing the hard line and wiring harness to the top of the frame. **See Photo 1.** The stock bolts can be accessed from the side of the vehicle. Retain the stock hardware for reuse.
3. Install the brake line bracket to the new bracket with the supplied 5/16" x 1" bolts, nuts /washers. Reinstall the assembly in the stock location with the stock hardware using a 13mm wrench. **See Photo 2. Torque to 20ft-lbs.**



Photo 1



Photo 2

4. Remove the e-brake wire bracket from the frame with a 13mm socket. Use the supplied drop bracket and the factory bolt to mount to the frame. Use the supplied 5/16" x 1" bolt, washers, and nut to mount factory wire bracket to the new drop bracket as shown in **See Photo 3. Torque to 20ft-lbs.**
5. Remove the ABS wire, if equipped, from the frame rail as shown in **Photo 4** to allow slack in the line.



Photo 3



Photo 4

6. Jack up the rear of the vehicle and place jack stands under the frame rails. Remove tire and wheels.
7. Lightly support the differential with a floor jack .
8. Remove the stock shock absorbers using a 21mm wrench. Retain the hardware for reuse.
9. Remove the stock u-bolts and lower the axle to allow the supplied block to be installed. Discard the factory block if so equipped.
10. Install the new block with the supplied 7/16" X 3" u-bolts on the leaf spring. Do not tighten at this time. Jack up the axle to meet the new block and make sure the center pin is in the axle. Tighten 7/16" u-bolts. **Torque to 45ft-lbs. See Photo 5. Note short side of block goes towards front of vehicle.**
11. Install the supplied u-bolts and tighten using a 22mm wrench and a crossing pattern. **See Photo 5. Torque to 90ft-lbs.**

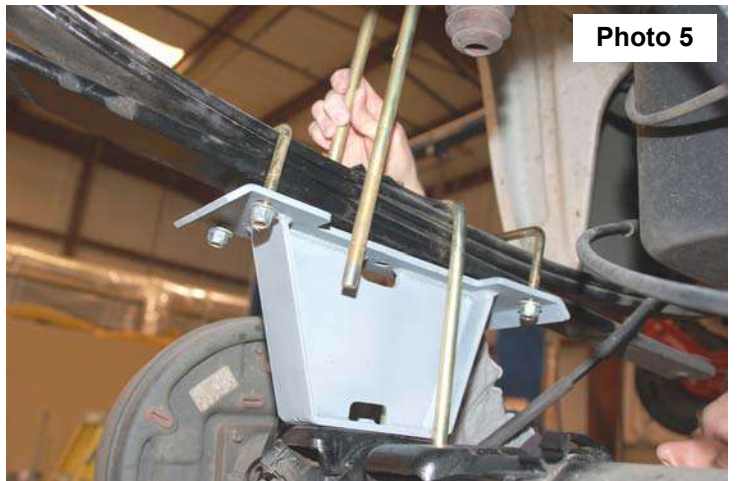

Photo 5

12. Install shock absorbers #660748 in the factory location tighten using a 21mm wrench. **If installing V2 rear shocks or Vertex rear shocks, refer to installation instructions included with those shocks. See Photo 6. Torque to factory specs.**
13. Using WD-40 lubricate the ABS wire and slide the rubber sleeve up to allow the wire to be reinstalled in the clip on the frame. The connector will not be reattached to the top of the frame. Reroute the lines as needed to gain sufficient slack.
14. Re-install tires and wheels.
15. Remove jack stands and lower vehicle to ground.
16. Place shock decals on shock absorbers and window decal on vehicle.



POST INSTALLATION INSTRUCTIONS

1. Check all fasteners for proper torque. Check to ensure for adequate clearance between all rotating, mobile, fixed, and heated members. Verify clearance between exhaust and brake lines, fuel lines, fuel tank, floor boards and wiring harness. Check steering gear for clearance. Test and inspect brake system.
2. Perform steering sweep to ensure front brake hoses have adequate slack and do not contact any rotating, mobile or heated members. Inspect rear brake hoses at full extension for adequate slack. Failure to perform hose check/ replacement may result in component failure.
3. On some vehicles the front lower skirting will need to be trimmed if using certain wheel /tire combinations and with heavy offset wheels. Trim only as needed.
4. Activate four wheel drive system and check front hubs for engagement.
5. Have a qualified alignment center align the vehicle immediately. Realign to factory specifications. The following are the recommended specifications:

Caster in degrees	4.5 +-1.0
Camber in degrees	0.0—.3
Toe In in degrees	0.1 +- .2
6. Perform head light check and adjustment to proper settings.
7. Check and retighten wheels at 50 miles and again at 500 miles.
8. All kit components must be retightened at 500 miles and then every three thousand miles after installation. Periodically check all hardware for tightness.
9. Install "Warning to Driver" decal on sun visor

Note: Installation of larger tires will require speedometer recalibration.

Thank you for choosing Rough Country for all of your suspension needs.

By purchasing any item sold by Rough Country, LLC, the buyer expressly warrants that he/she is in compliance with all applicable Federal, State, and Local laws and regulations regarding the purchase, ownership, and use of the item. It shall be the buyers responsibility to comply with all Federal, State and Local laws governing the sales of any items listed, illustrated or sold. The buyer expressly agrees to indemnify and hold harmless Rough Country, LLC for all claims resulting directly or indirectly from the purchase, ownership, or use of the items.

When it comes to quality performance suspension parts, Rough Country is the brand you can depend on.