



5315 Mazda CX 5 2013-2016

Installation Instructions



50 Min.

NOTE: Before starting this installation make sure all the hardware is included and this part number matches your vehicle.

MAZDA CX 5 2012 - PRESENT



4		DIN 6921;M10x25
6		DIN 6923;M10

8		DIN 125;M6
2		HTC269 M10

10		DIN 6923 M6x25
2		HTC 262 M10x30 (5x15x60)

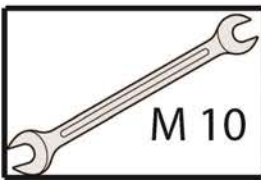
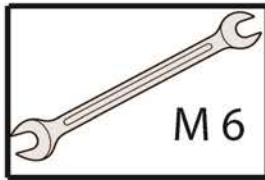
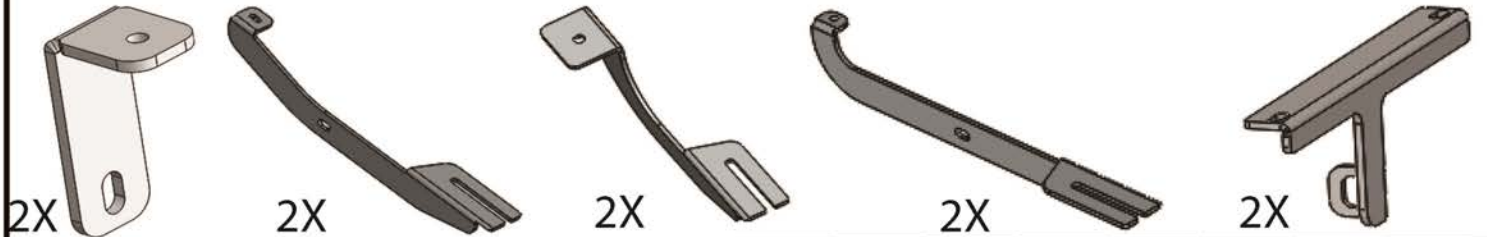

M6 = 8 Ft.Lb
M8 = 18 Ft.Lb
M10 = 35 ft.Lb

ATTENTION PLEASE! : DO NOT TIGHTEN ALL OF THE SCREWS UNTIL ALL OF THE PARTS ARE INSTALLED.

Keep your Romik accessories clean. To prevent corrosion and to maintain your high quality finish, wax or polish regularly with quality stainless polish. Use a non abrasive type automotive wax. Any use of abrasive soaps, polishes or waxes can be detrimental to the finish.

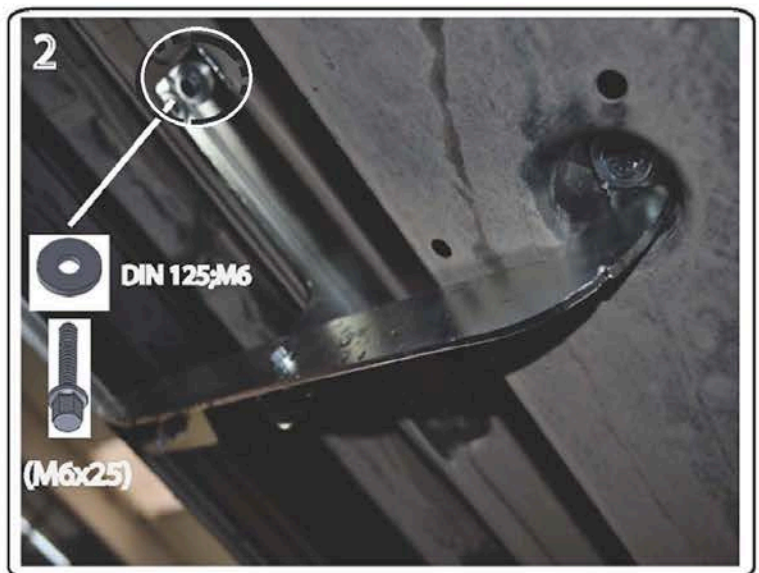
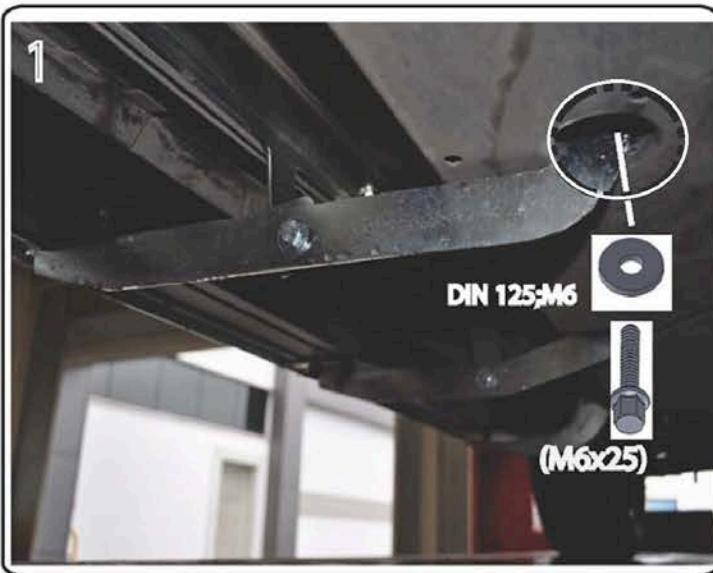

- 1) Locate front mounting area and remove factory bolt
- 2) Locate extra support area and remove factory bolts
- 3) Install front main support Pic #1 with supplied hardware M6x25
- 4) Install extra support Pic #2 with supplied hardware M6x25 Make sure all hardware is hand tight

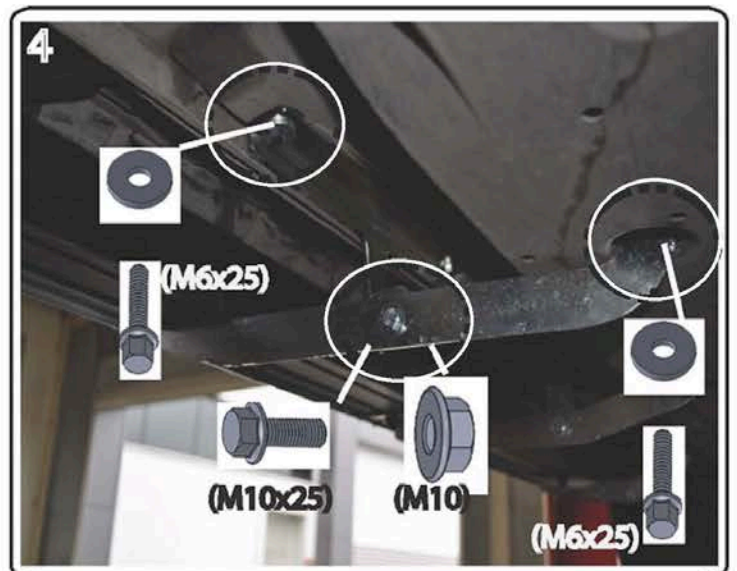
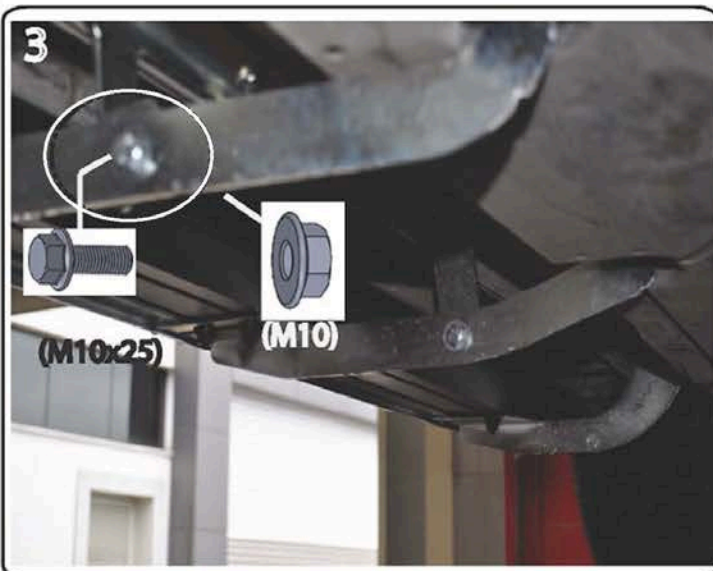

- 5) Attach extra support bracket to main bracket using supplied M10x25 hardware hand tight only

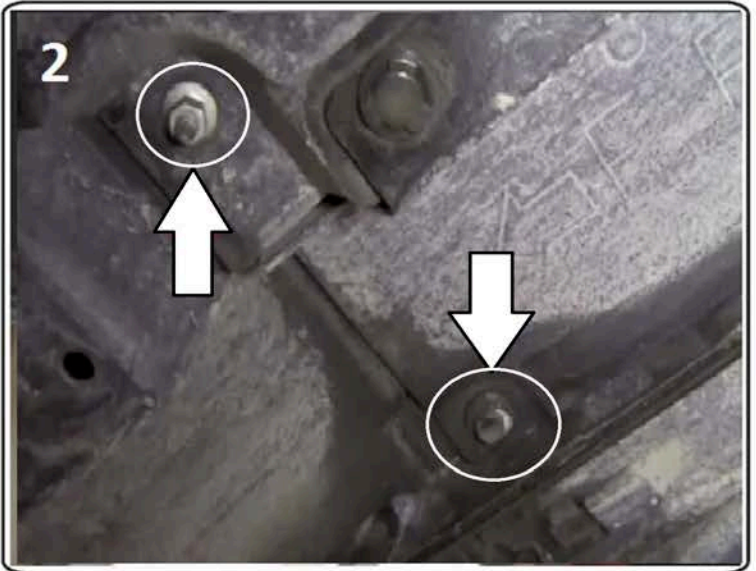
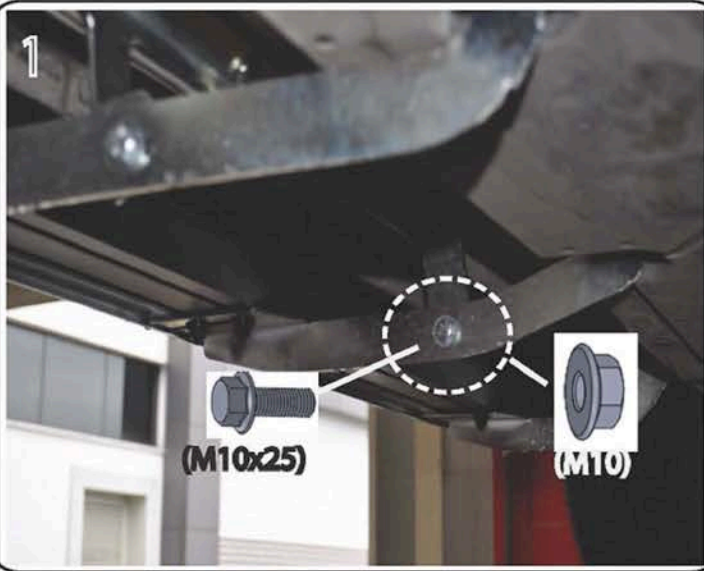

- 6) Locate middle bracket install area. Remove factory bolts as shown on Pic #2
- 7) Install main middle bracket re-using factory hardware Pic #4
- 8) Install extra support using supplied M6x25 as shown on Pic #4
- 9) Attach extra support to middle bracket using supplied M10x25 as shown on Pic #1
- 10) Make sure all brackets are hand tight only.

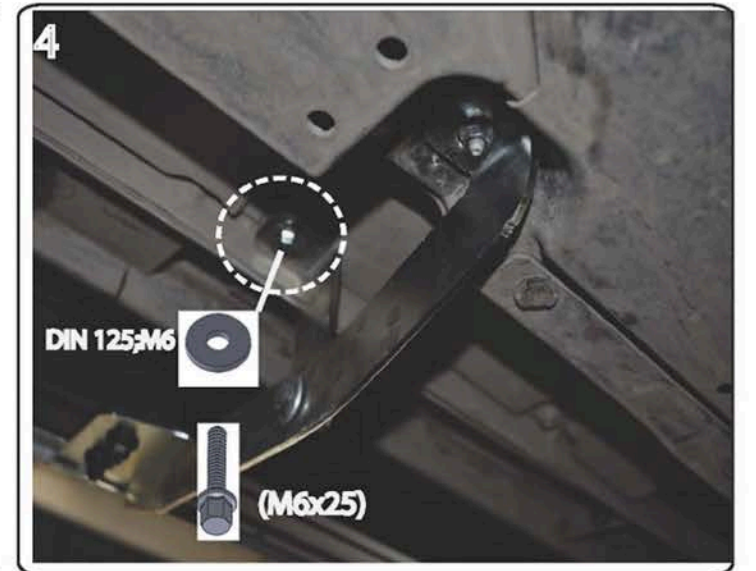

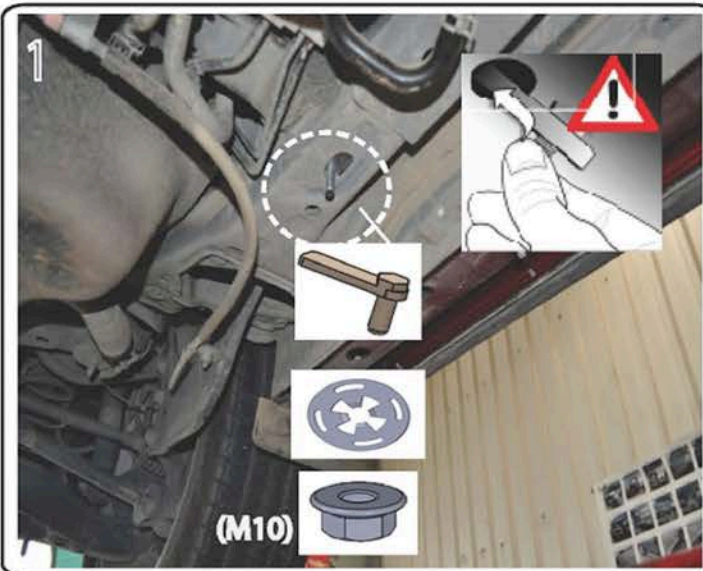

- 11) Locate rear bracket area. NOTE on some models you may need to remove and cut the plastic panel
12) Once rear are is located proceed to install supplied HTC 262 and proceed to attach rear bracket. Make sure this is hand tight only.
13) At this point proceed to install running boards onto brackets and center them as desired. Please make sure they are hand tight only.
14) Proceed to tighten all hardware M6 8 ft lbs / M8 18 ft lbs / M10 35 ft lbs



- 15) Once all the brackets are tight proceed to tighten the running boards to 18 ft lbs.

MAZDA CX5 2013-2016



WARNING: USE OF POWER TOOLS WILL VOID YOUR WARRANTY

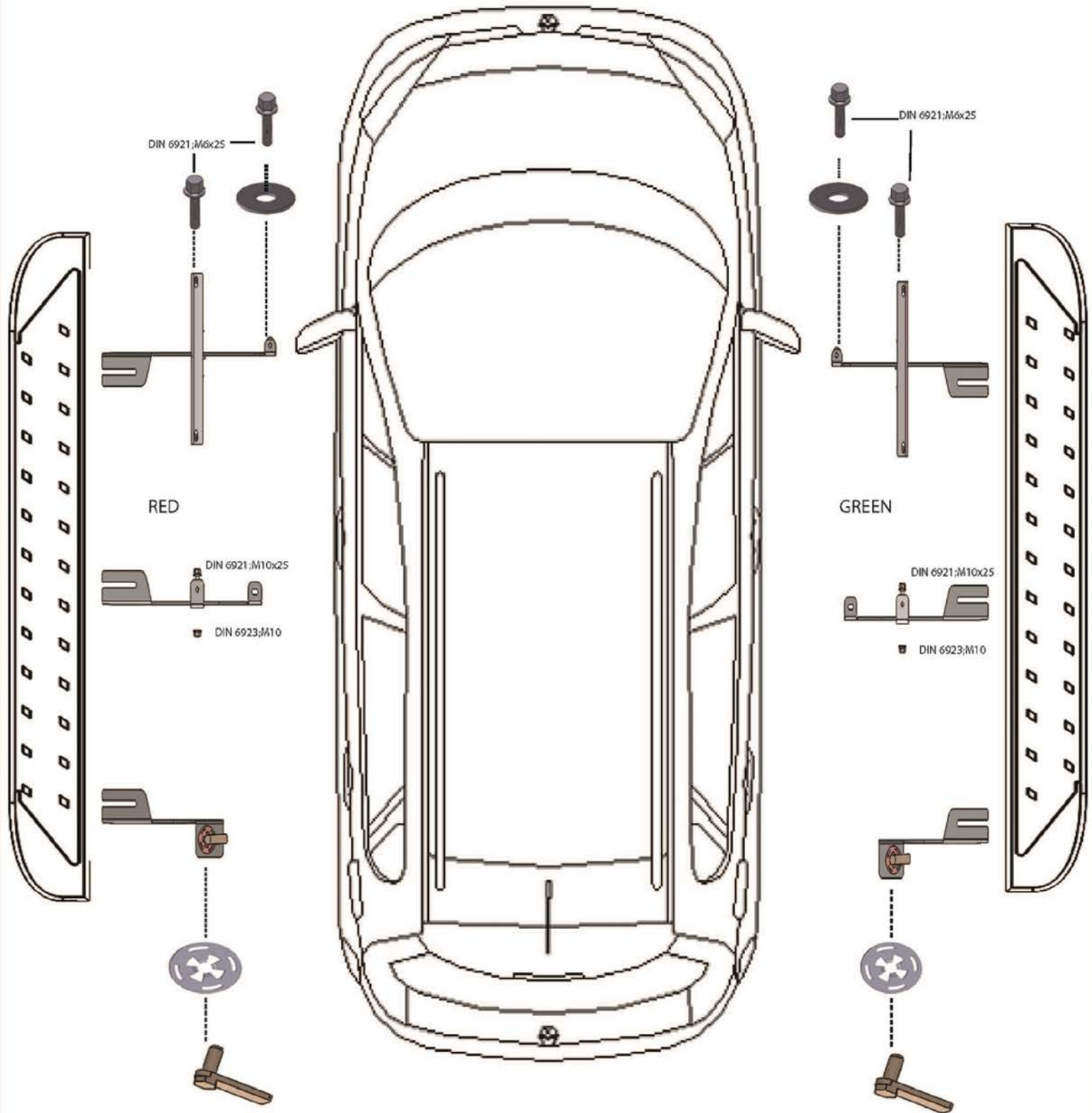

On our website you'll find a wide variety of high-quality [Running Boards & Step Bars](#) from [Romik](#).