



2326 – HYUNDAI SANTA FE 2013 PRESENT

Installation Instructions



60 Minutes

M6 = 8 Ft.Lb
 M8 = 18 Ft.Lb
 M10 = 35 ft.Lb



5 PASSENGER
 7 PASSENGER

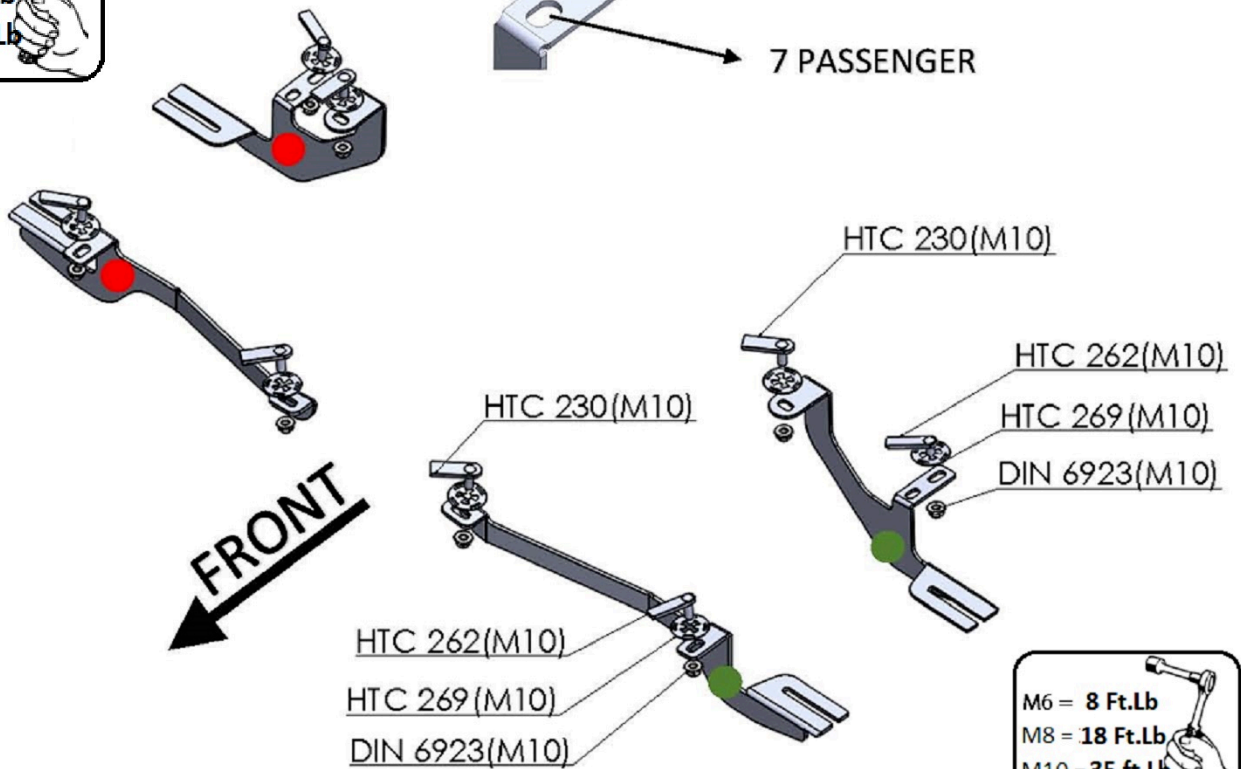

M6 = 8 Ft.Lb
 M8 = 18 Ft.Lb
 M10 = 35 ft.Lb

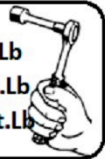

HARDWARE

4		HTC 230 M10x25(4x20x60)	4		HTC 262 M10x30(4x15x60)	8		HTC 269 KLIPS (M10)
---	--	----------------------------	---	--	----------------------------	---	--	------------------------

8		DIN 6923 (M10)
---	--	----------------

WARNING: Use of powertools will void warranty

BRACKETS

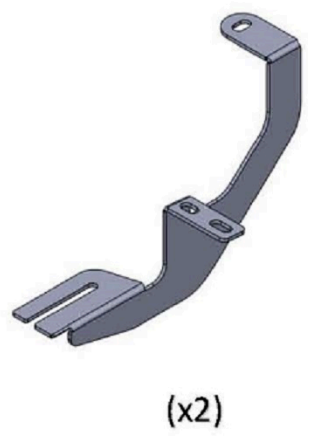
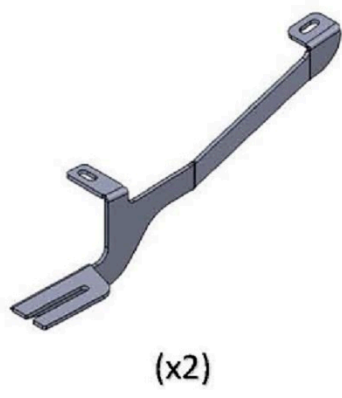

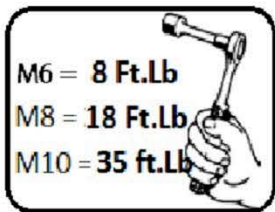

- 1) Locate front mounting area and remove rubber plugs on two locations as shown below
- 2) Proceed to insert HTC 230 and HTC 262
- 3) Proceed to install front bracket, hand tight only.

WARNING: Use of powertools will void warranty

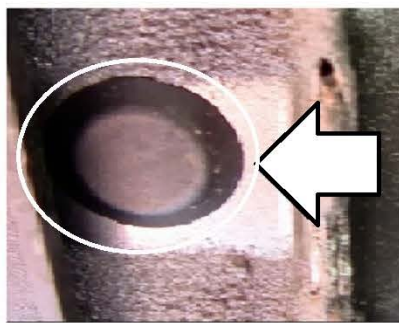
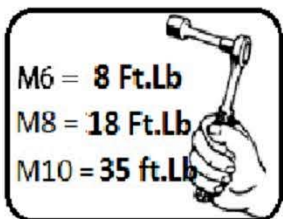
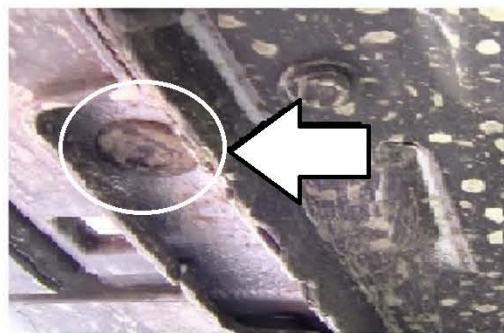
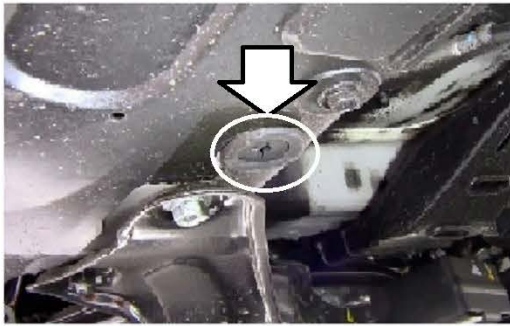

- 1) Remove rubber plugs on two locations as shown above
- 2) Proceed to install HTC 230 and HTC 262
- 3) Proceed to install bracket hand tight only
- 4) Proceed to install running boards hand tight only
- 5) Torque M10 to 35 ft lb and M8 to 18 Ft.Lb

M6 = 8 Ft.Lb

M8 = 18 Ft.Lb

M10 = 35 Ft.Lb

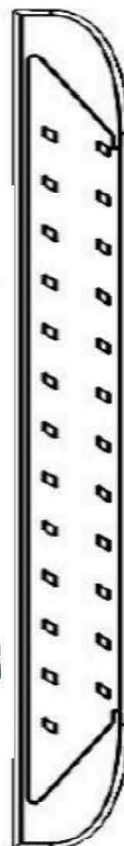
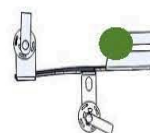
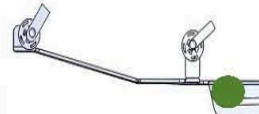
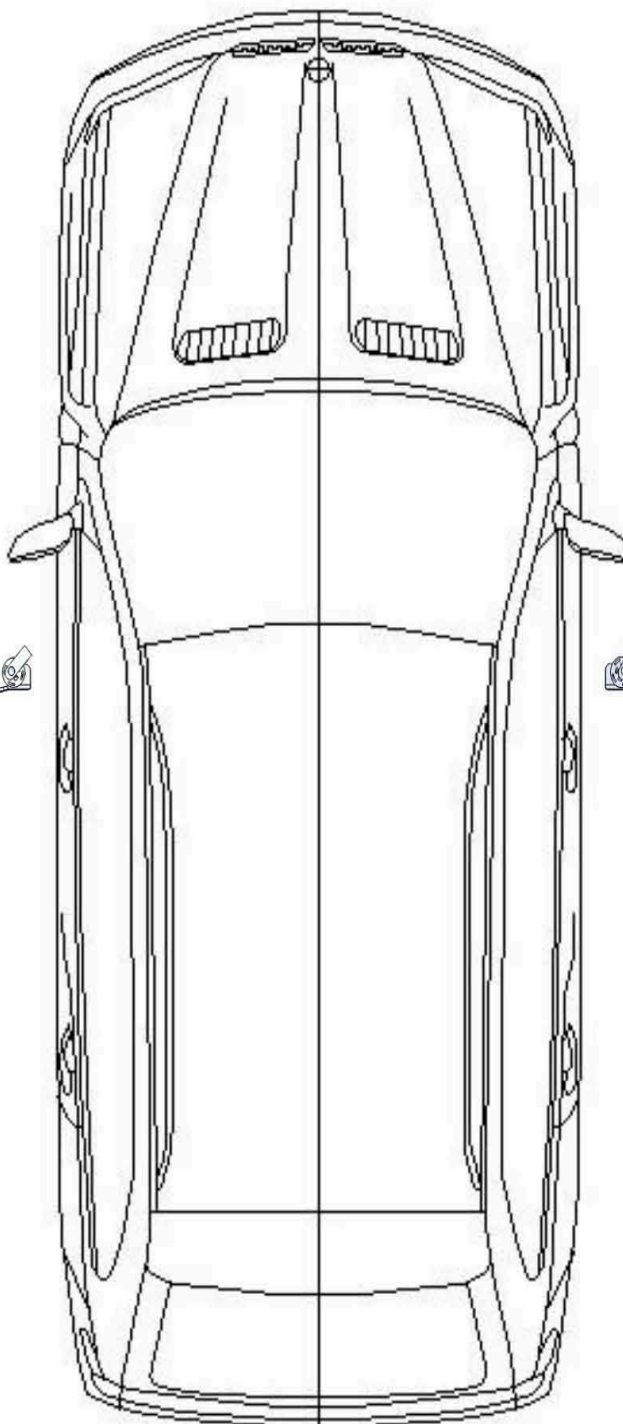
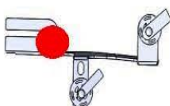
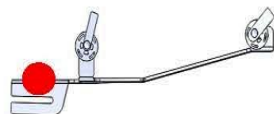
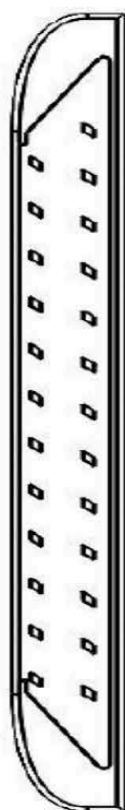

ATTENTION PLEASE! : DO NOT TIGHTEN ALL OF THE SCREWS UNTIL ALL OF THE PARTS ARE INSTALLED.

Keep your Romik accessories clean. To prevent corrosion and to maintain your high quality finish, wax or polish regularly with quality stainless polish. Use a non abrasive type automotive wax. Any use of abrasive soaps, polishes or waxes can be detrimental to the finish.

On our website you'll find a wide variety of high-quality Running Boards & Step Bars from Romik.