



2322 Hyundai Tucson 2010-2015
2322 Kia Sportage 2011-2016

Installation Instructions



60 Minutes

NOTE : Before starting this installation make sure all the hardware is included and this part number matches your vehicle

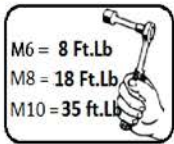

WARNING: Use of powertools will void warranty

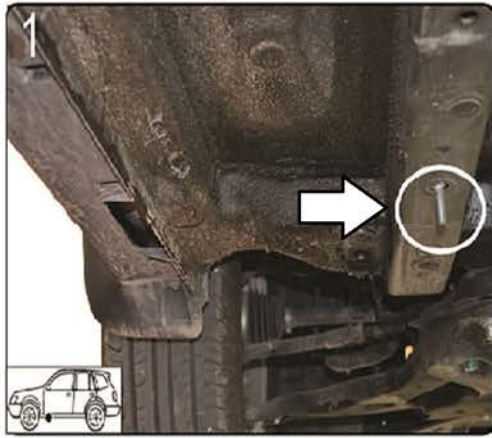

- 1) Locate front mounting area remove rubber plugs as shown on two locations
- 2) Proceed to install HTC 243 and HTC 230
- 3) Proceed to install front brackets hand tight only.

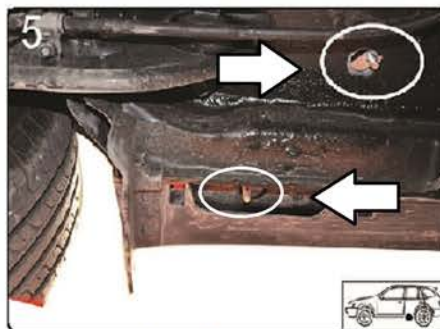
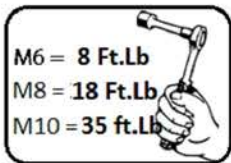

- 1) Locate rear mounting area and remove any rubber plugs
- 2) Proceed to install HTC 230 on both locations
- 3) Proceed to install rear bracket hand tight only
- 4) Proceed to install running boards hand tight only
- 5) Proceed to torque hardware on brackets M10 35 Ft.Lb M8 18 Ft.Lb
- 6) Proceed to torque hardware on running boards M8 18 Ft.Lb

WARNING: Use of powertools will void warranty



60 Minutes

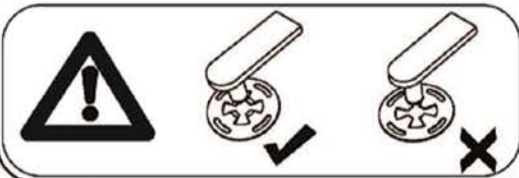
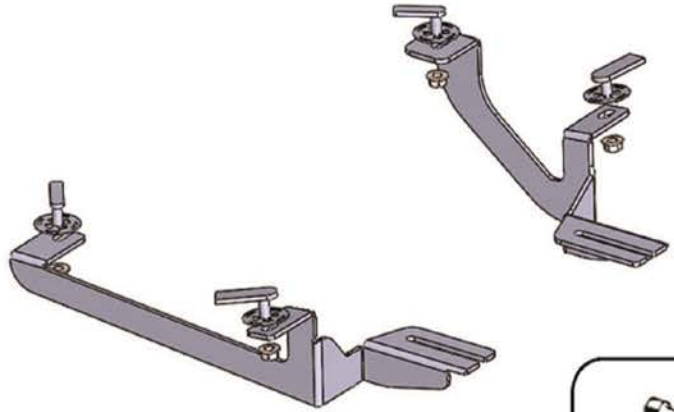
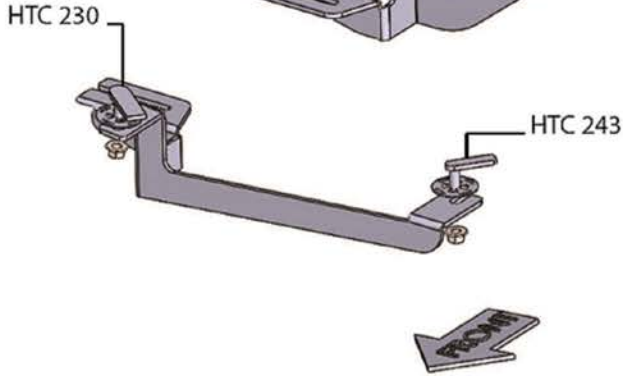
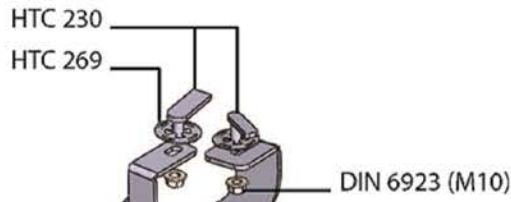

Please inspect all components before starting the installation.

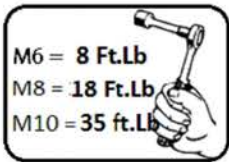

WARNING: Use of powertools will void warranty

Romik