



2618 - JEEP PATRIOT 2008-PRESENT

Installation Instructions



60 Minutes

NOTE: Before starting this installation makes sure that all hardware matches these instructions.

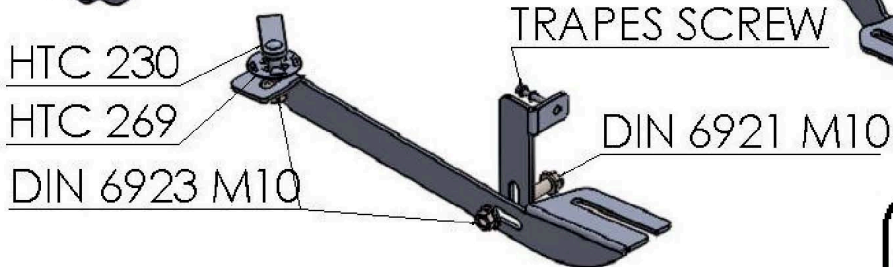
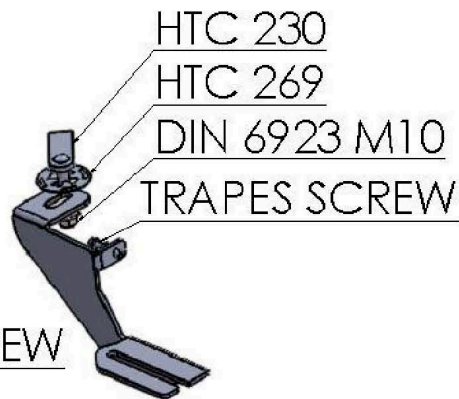
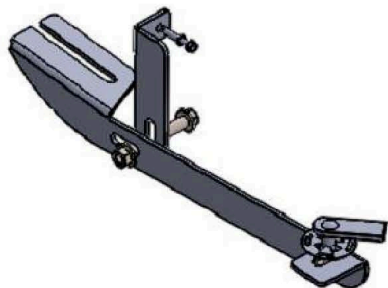
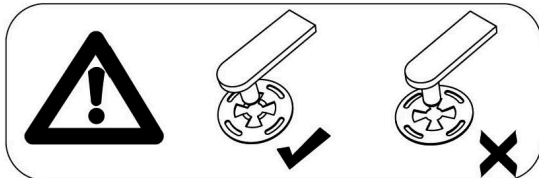

FRONT

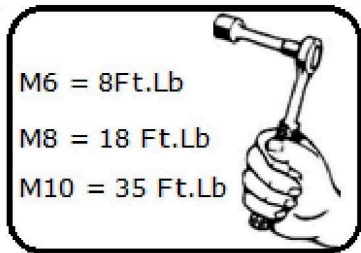

HARDWARE

4		HTC 230 M10x25(4x20x60)
---	--	----------------------------

2		DIN 6921 FLANGE BOLT M10x25
---	--	--------------------------------

4		HTC 269 KLIPS (M10)
---	--	------------------------

6		DIN 6923 NUT M10
---	--	---------------------

4		DIN 7504 TRAPEZ SCREW M5x30
---	--	--------------------------------

BRACKETS



(x2)

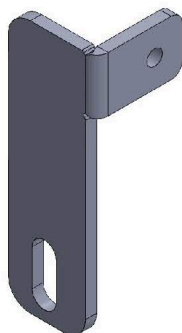

(x2)

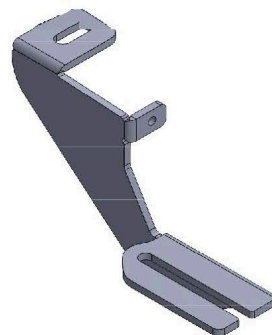

(x2)

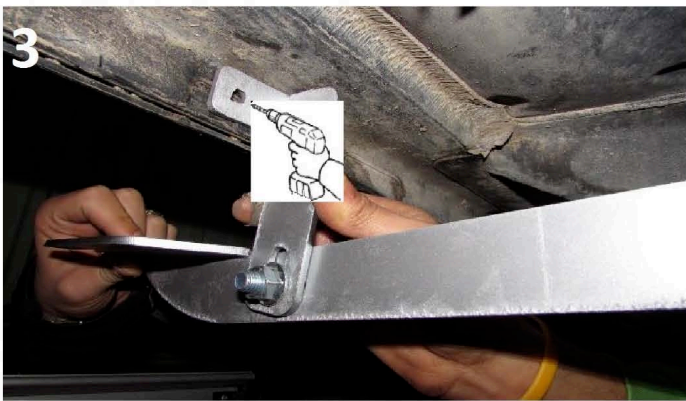
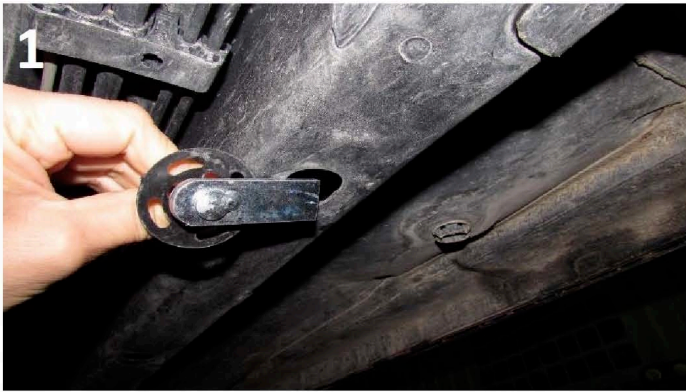
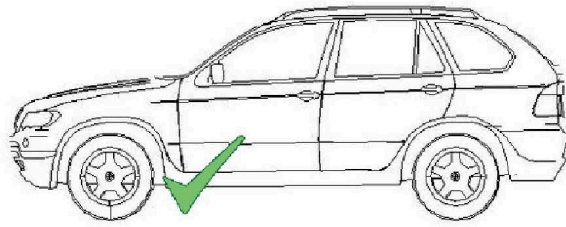

- 1) Locate front mounting area and remove rubber plug.
- 2) Install HTC 230 with HTC 269 as shown on image #1.
- 3) Install front bracket as shown on image #2.
- 4) Put extra support bracket then mark hole for screw and install this bracket as shown on image #3 and #4.
- 5) Connect extra support bracket with main bracket using supplied M10X25 bolt and nut as shown on image #3 and #4.
- 6) Tighten brackets hardware M10 to 35 ft lbs. **WARNING:** Do not use powertools.
- 7) Repeat procedure on opposite side.
- 8) Do not tighten anything yet and proceed to the rear bracket area.

Note: Use of powertools will damage products and void your warranty.

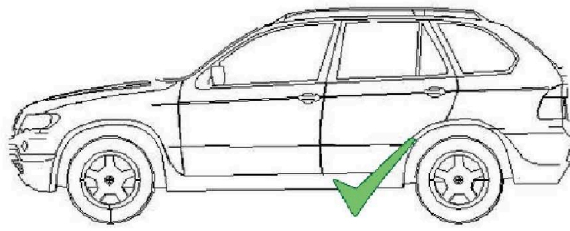

- 1) Locate rear mounting area and remove rubber plug.
- 2) Install HTC 230 with HTC 269 as shown on image #1.
- 3) Proceed to mark hole for screw and install rear bracket as shown on image #3 and #4.
- 4) Tighten brackets hardware M10 to 35 ft lbs. **WARNING:** Do not use powertools.
- 5) Repeat procedure on opposite side.
- 6) Do not tighten anything yet.

Note: Use of powertools will damage products and void your warranty.

2618 - JEEP PATRIOT 2008-PRESENT

Note: Use of powertools will damage products and void your warranty.

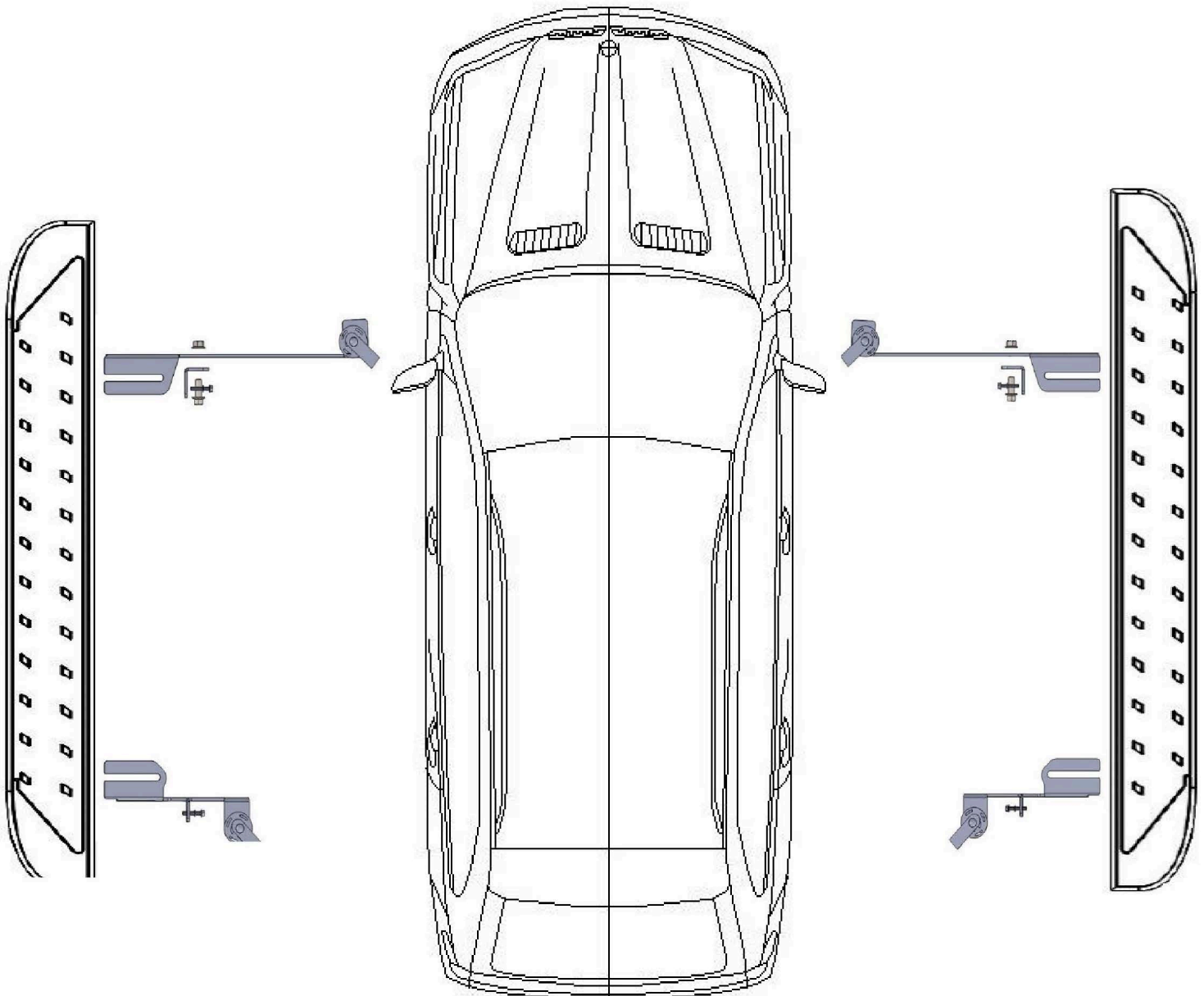

ATTENTION PLEASE! : DO NOT TIGHTEN ALL OF THE SCREWS UNTIL ALL OF THE PARTS ARE INSTALLED.

Keep your Romik accessories clean. To prevent corrosion and to maintain your high quality finish, wax or polish regularly with quality stainless polish. Use a non abrasive type automotive wax. Any use of abrasive soaps, polishes or waxes can be detrimental to the finish.

On our website you'll find a wide variety of high-quality Running Boards & Step Bars from Romik.