



5417 Kia Sportage 2017-Present
2328 Hyundai Tucson 2015-Present

Installation Instructions



60 Minutes

M6 = 8 Ft.Lb
M8 = 18 Ft.Lb
M10 = 35 ft.Lb

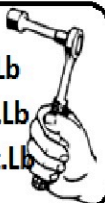
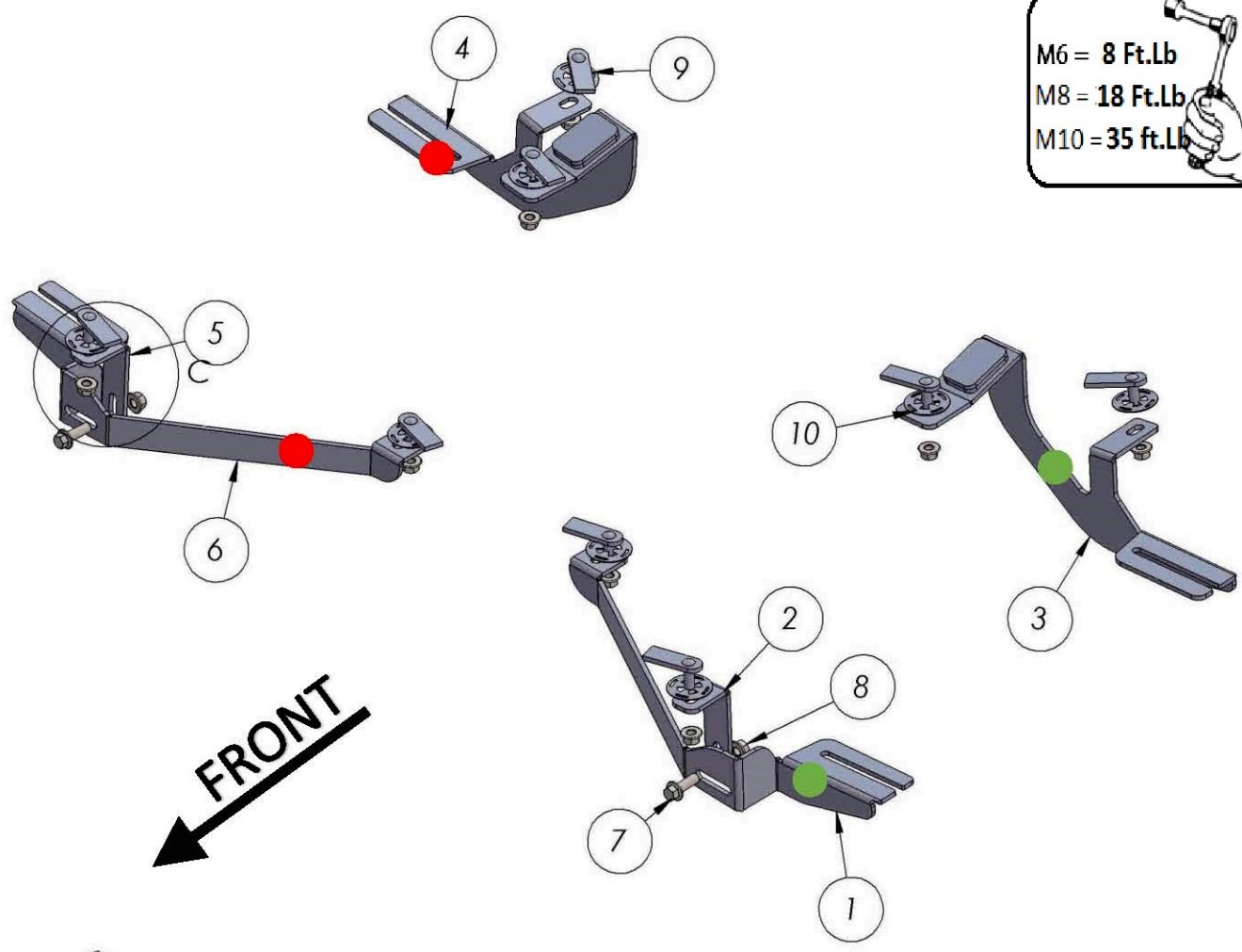
NOTE : **Kia Sportage 2017+ please reverse the extra support**

ITEM	PART NAME	QTY
1	5417850F0 DRIVER	1
2	5417850F1 DRIVER	1
3	5417850B0 DRIVER	1
4	5417850B0 PASSENGER	1
5	5417850F1 PASSENGER	1
6	5417850F0 PASSENGER	1
7	DIN 6921 FLANGE BOLT M10 x 30	2
8	DIN 6923 FLANGE NUT M10	10
9	HTC 230 - M10x25(5x20x60)	8
10	HTC 269 CLIPS (M10)	8

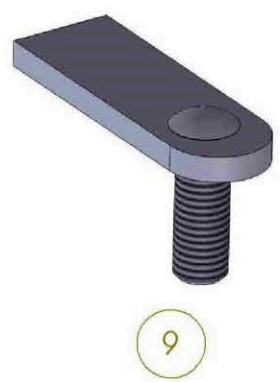

9



10

M6 = 8 Ft.Lb
M8 = 18 Ft.Lb
M10 = 35 ft.Lb

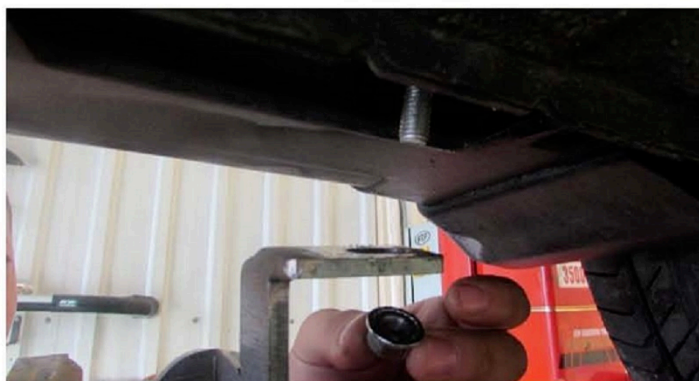
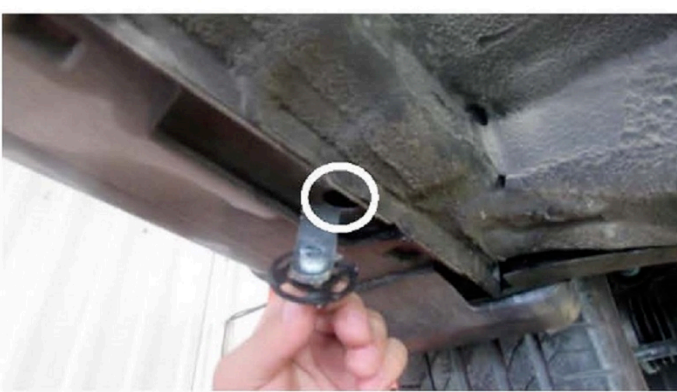
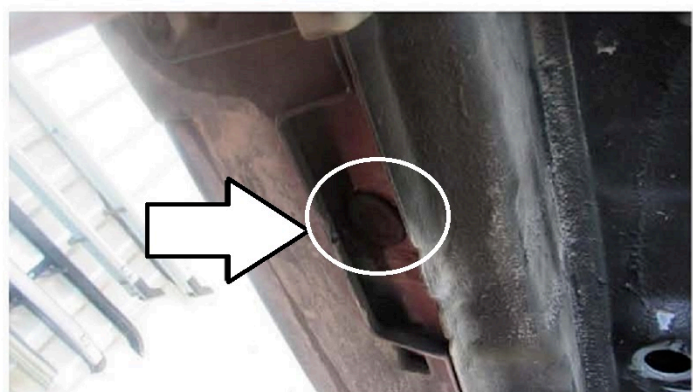
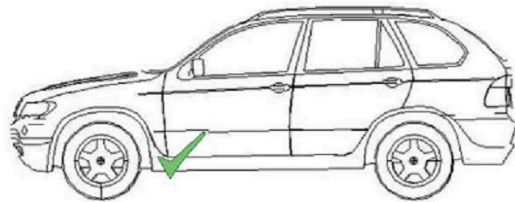

- 1) Locate front mounting area, remove rubber plugs as shown above.
- 2) Proceed to install HTC 230
- 3) Proceed to install front bracket hand tight only

Warning: Use of power tools will void warranty

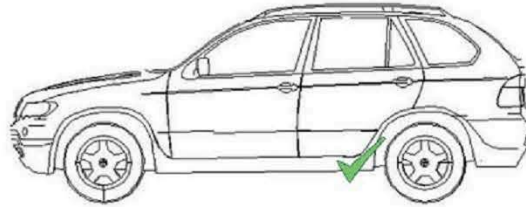
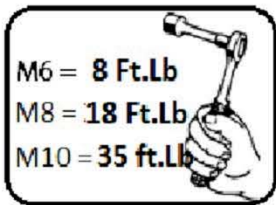

- 1) Locate rear mounting area and remove rubber plugs as shown above.
- 2) Proceed to install HTC 230
- 3) Proceed to install rear brackets hand tight only
- 4) Proceed to install running boards hand tight only
- 5) Proceed to torque bracket hardware M10 to 35 Ft.Lb
- 6) Proceed to torque running board hardware M8 to 18 Ft.Lb

WARNING: Use of powertools will void warranty

M6 = 8 Ft.Lb
M8 = 18 Ft.Lb
M10 = 35 ft.Lb

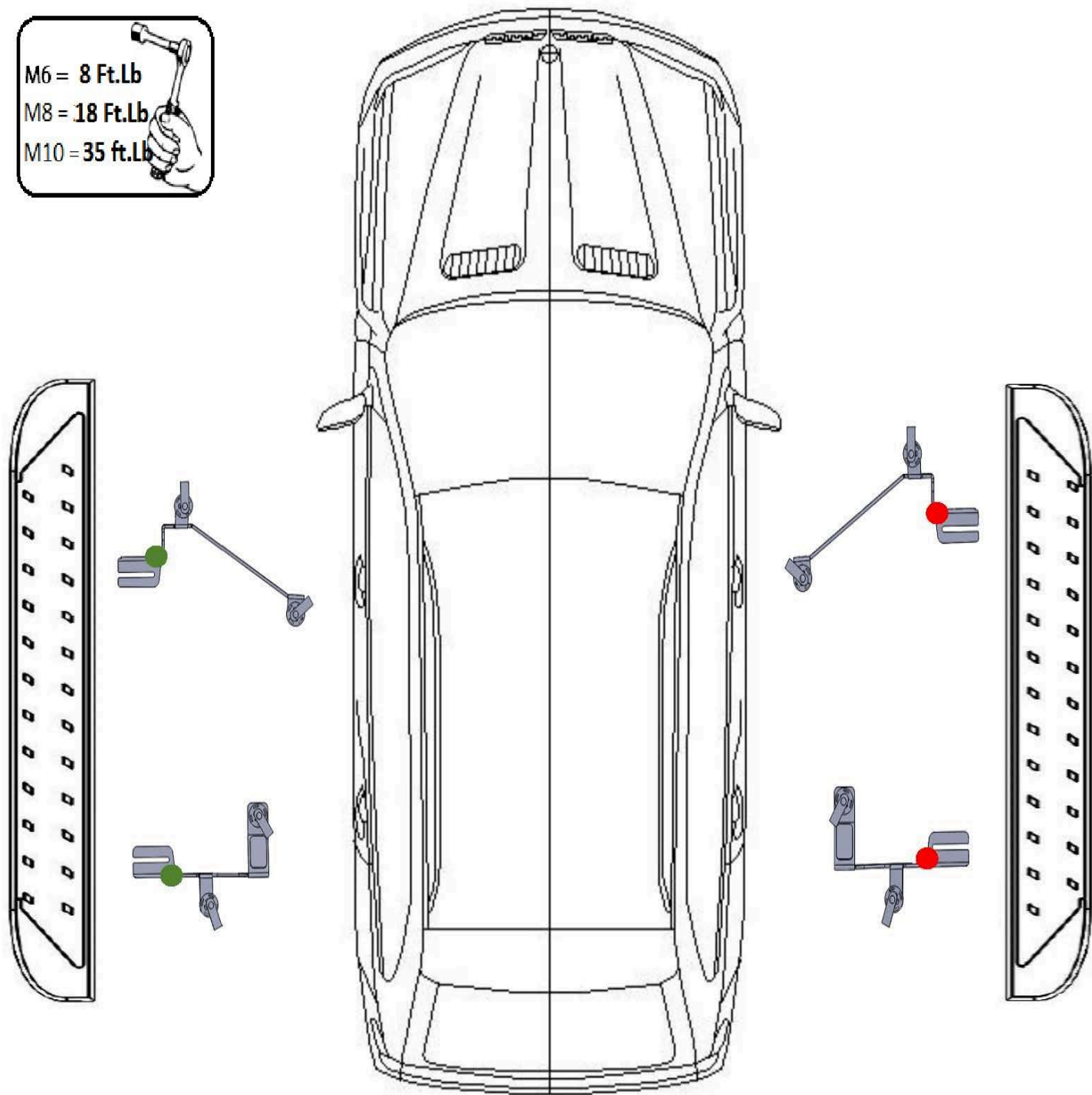
ATTENTION PLEASE! : DO NOT TIGHTEN ALL OF THE SCREWS UNTIL ALL OF THE PARTS ARE INSTALLED.

Keep your Romik accessories clean. To prevent corrosion and to maintain your high quality finish, wax or polish regularly with quality stainless polish. Use a non abrasive type automotive wax. Any use of abrasive soaps, polishes or waxes can be detrimental to the finish.

On our website you'll find a wide variety of high-quality Running Boards & Step Bars from Romik.