

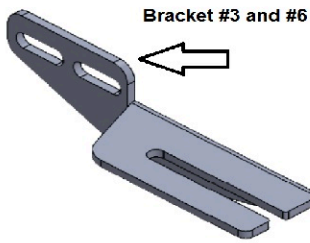

**2614 Jeep Grand Cherokee 2011-2017**

*Fits: Laredo, Overland, High Altitude, Limited, Summit and Trailhawk models without factory rock guards. Does not fit SRT*



Bracket #3 and #6

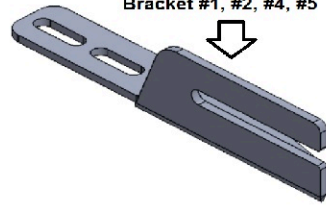

Bracket #1, #2, #4, #5

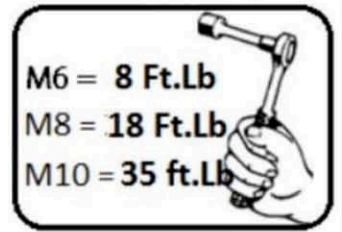

M6 = 8 Ft.Lb

M8 = 18 Ft.Lb

M10 = 35 ft.Lb

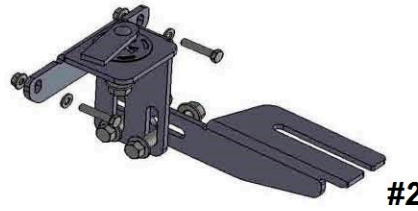
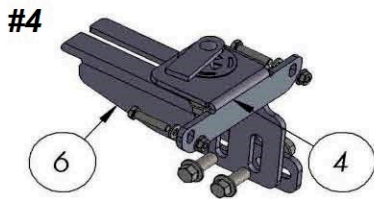
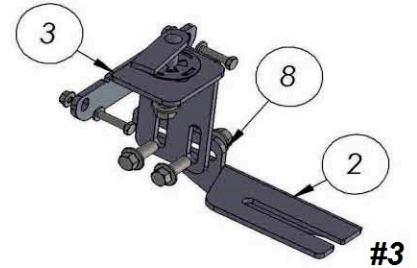
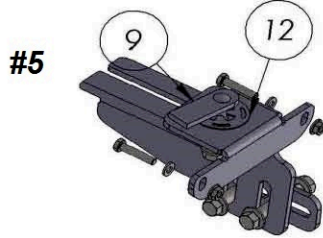
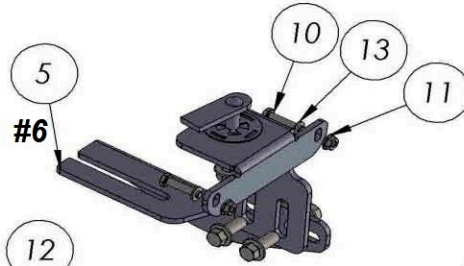

FRONT



#1 ← Bracket order for all models except "Summit"

ITEM/NO	PART NAME/PARÇA ADI	QTY/ADET
1	2614850F0C0 DRIVER-PASSENGER	2
2	2614850B0 DRIVER	1
3	2614850FCB0 DRIVER	3
4	2614850FCB0 PASSENGER	3
5	2614850B0 PASSENGER	1
6	2614850F0C0 PASSENGER - DRIVER	2
7	DIN 6921 FLANGEBOLT M10 x 25	12
8	DIN 6923 FLANGE NUT M10	18
9	HTC 230 - M10x25(5x20x60)	6
10	DIN 6921 FLANGE BOLT M6 x 30	12
11	DIN 6923 FLANGE NUT M6	12
12	HTC 269 CLIPS / KLIPS (M10)	6
13	DIN 125 WASHER - M6	12

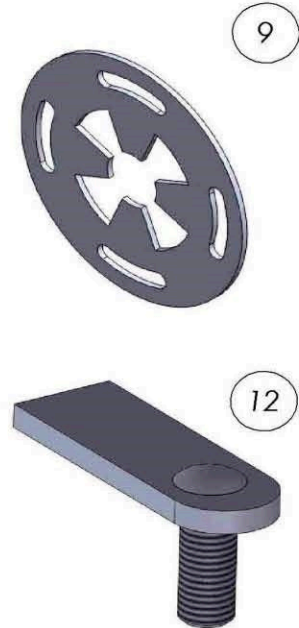

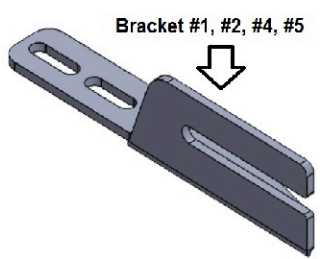
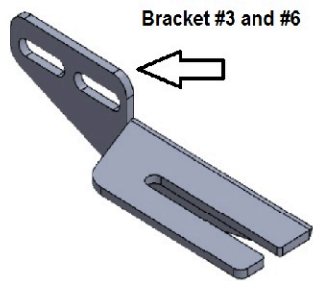

M6 = 8 Ft.Lb  
M8 = 18 Ft.Lb  
M10 = 35 ft.Lb

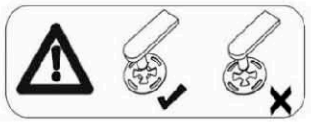
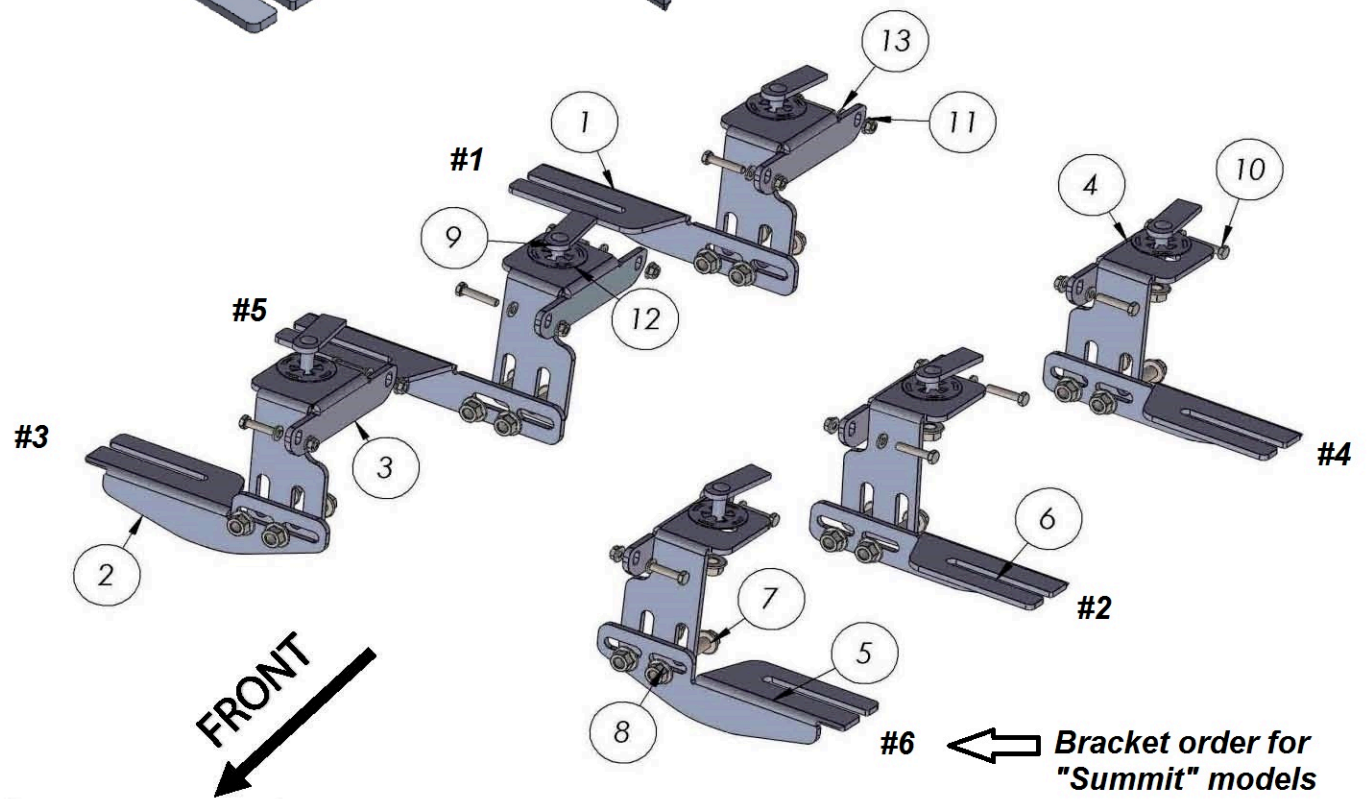

ITEM/NO	PART NAME/PARÇA ADI	QTY/ADET
1	26 14850F0C0 PASSENGER	2
2	26 14850B0 PASSENGER	1
3	26 14850FCB0 PASSENGER	3
4	26 14850FCB0 DRIVER	3
5	26 14850B0 DRIVER	1
6	26 14850F0C0 DRIVER	2
7	DIN 6921 FLANGE BOLT M10 x25	12
8	DIN 6923 FLANGENUT M10	18
9	HTC 230 - M10x25(5x20x60)	6
10	DIN 6921 FLANGE BOLT M6 x 30	12
11	DIN 6923 FLANGE NUT M6	12
12	HTC 269 CLIPS / KLIPS (M10)	6
13	DIN 125 WASHER - M6	12

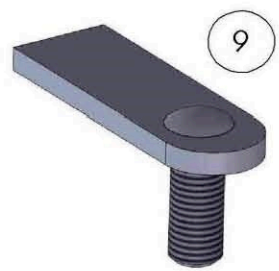



***Please make sure to look at bracket placement pages 2a and 2b of this manual for correct model order.***

- 1) Locate and remove factory plastic or rubber coverings as shown on pic # 1***
- 2) Install supplied HTC 230 with HTC 269 as shown on pic # 3***
- 3) Install upper portion of mounting bracket using supplied DIN 6923 hardware as shown on pic #5 and diagram page 2a or 2b leave hardware hand tight only***
- 4) Install lower portion of bracket according to your model as shown on pic # 6 using supplied DIN 6921 hardware leave hardware hand tight only.***

***Proceed to middle brackets***

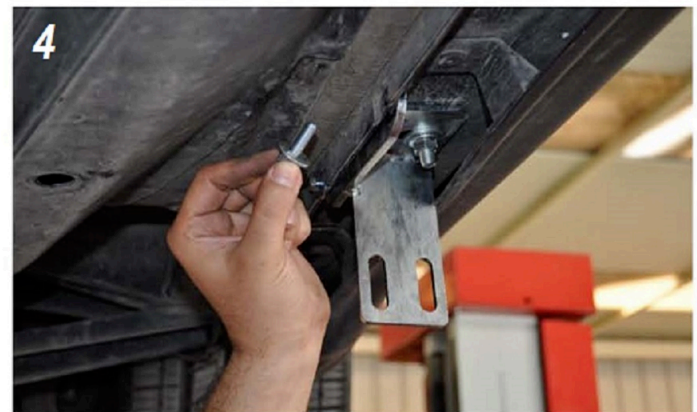
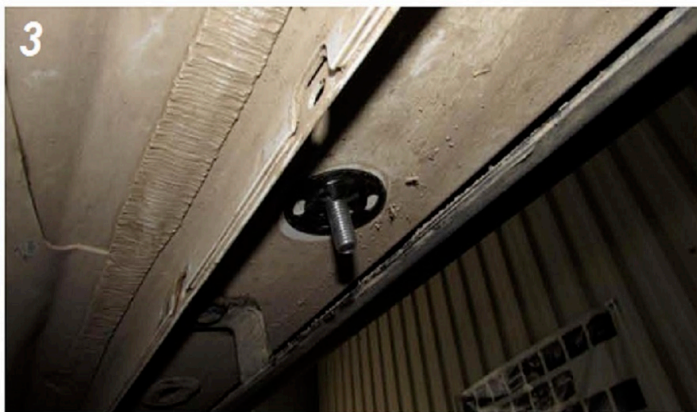

*Please make sure to look at bracket placement pages 2a and 2b of this manual for correct model order*

- 1) Locate and remove factory plastic or rubber coverings as shown on pic # 1**
- 2) Install supplied HTC 230 with HTC 269 as shown on pic # 2 and # 3**
- 3) Install upper portion of mounting bracket using supplied DIN 6923 hardware as shown on pic # 4 and diagram page 2a or 2b leave hardware hand tight only**
- 4) Install lower portion of bracket # 2 and # 5 pic # 5 using supplied DIN 6921 hardware leave hardware hand tight only.**

*Proceed to rear brackets*



*Please make sure to look at bracket placement pages 2a and 2b of this manual for correct model order.*

- 1) Locate and remove factory plastic or rubber coverings as shown on pic # 1**
- 2) Install supplied HTC 230 with HTC 269 as shown on pic # 2**
- 3) Install upper portion of mounting bracket using supplied DIN 6923 hardware as shown on pic # 3 and diagram page 2a or 2b leave hardware hand tight only**
- 4) Install lower portion of bracket according to your model as shown on pic # 5 using supplied DIN 6921 hardware leave hardware hand tight only.**

#### ***Install running boards***

- 5) Loosen M8 hardware on back of running boards and slide onto brackets**
- 6) Use a level to adjust pitch, tighten M8 bolts on running boards hand tight only**
- 7) Once running boards are leveled proceed to tighten M10 hardware to 35 ft lbs and M6 to 8 ft lbs**
- 8) You may now tighten the bottom of the running boards M8 to 18 ft lbs. Do not use power tools as this may damage the running boards and void your warranty.**

***Video installation is available for this model please scan QR code on page 1***

# 2614 - JEEP GRAND CHEROKEE 2012 - PRESENT

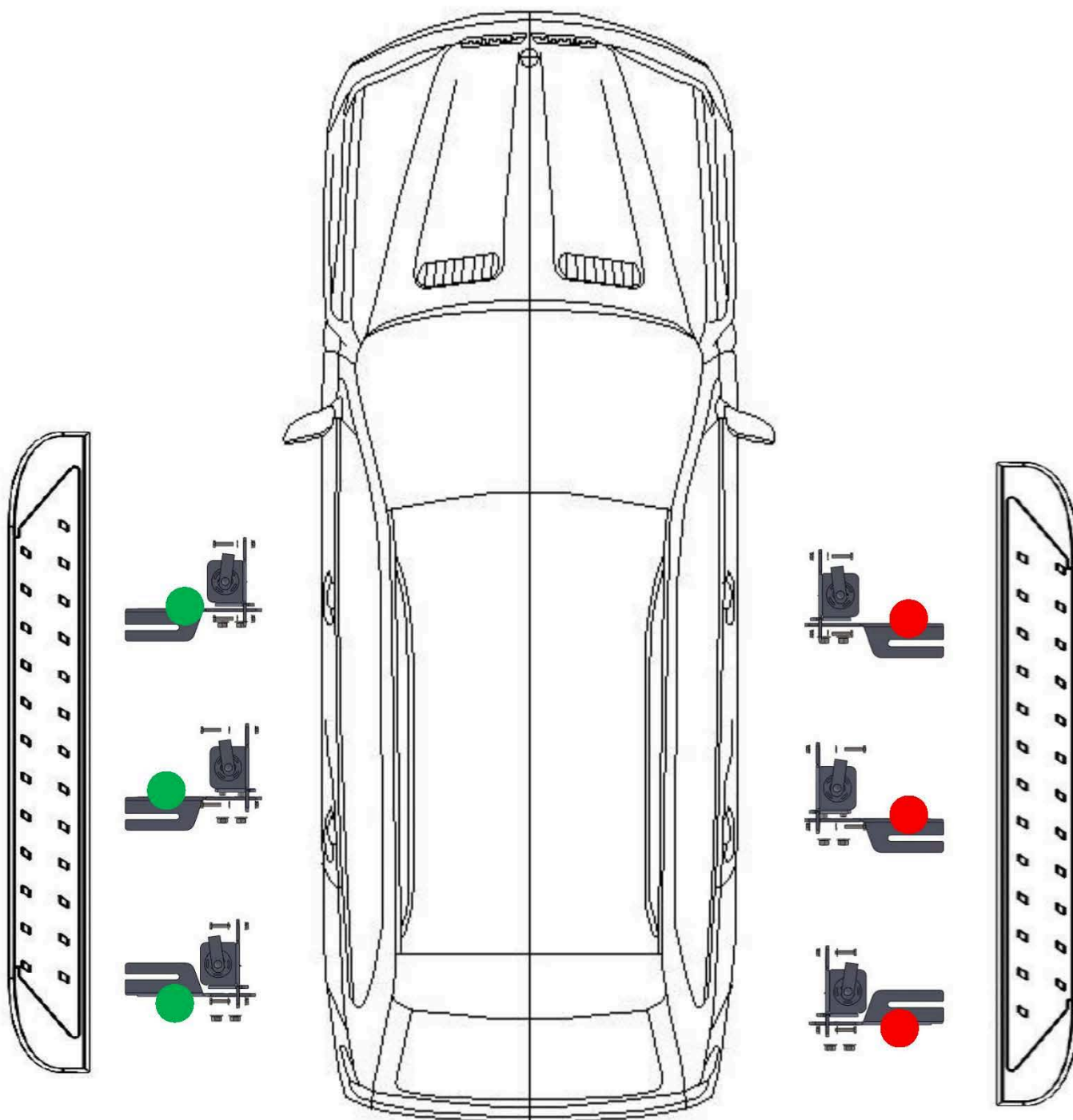

ATTENTION PLEASE! : DO NOT TIGHTEN ALL OF THE SCREWS UNTIL ALL OF THE PARTS ARE INSTALLED.

Keep your Romik accesories clean. To prevent corrsion and to maintain your high quality finish, wax or polish regulary with quality stainless polish. Use a non abrasive type automotive wax. Any use of abrasive soaps, polishes or waxes can be detrimental to the finish.

On our website you'll find a wide variety of high-quality Running Boards & Step Bars from Romik.