



3125 - MITSUBISHI OUTLANDER 2013-PRESENT

Installation Instructions



50 Min.

NOTE: Before starting this installation makes sure that all hardware matches these instructions.

Note: Use of powertools will damage the product and void your warranty.

M6 = 8Ft.Lb
M8 = 18 Ft.Lb
M10 = 35 Ft.Lb

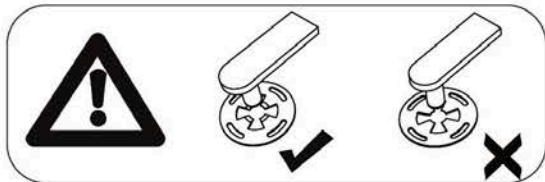
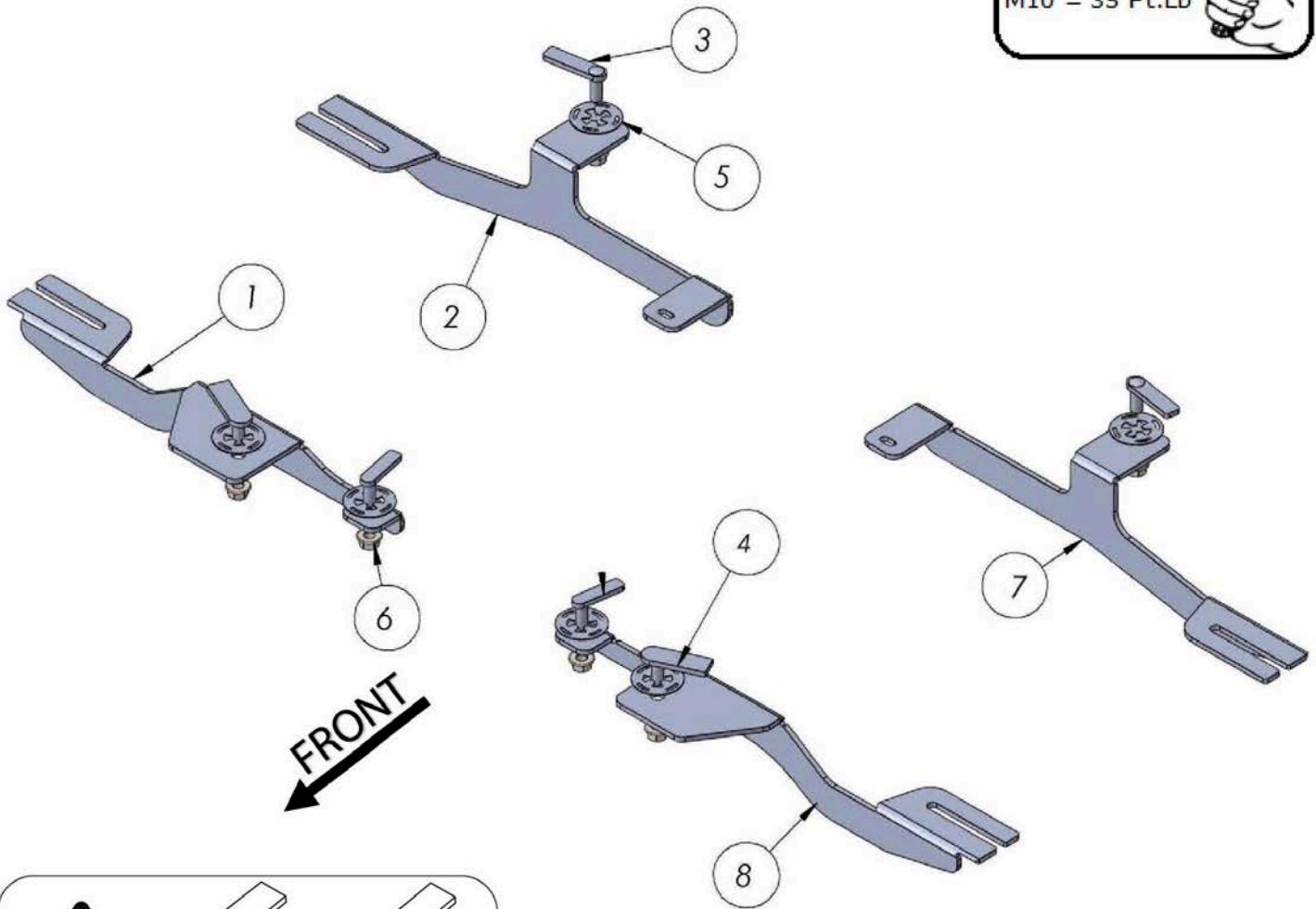

ITEM	PART NAME	QTY
1	3125850F0 PASSENGER	1
2	3125850B0 PASSENGER	1
3	HTC 262 - M10x30(5x15x60)	4
4	HTC 230 - M10x25(5x20x60)	2
5	HTC 269 - KLIPS (M10)	6
6	DIN 6923 FLANGE NUT M10	6
7	3125850B0 DRIVER	1
8	3125850F0 DRIVER	1

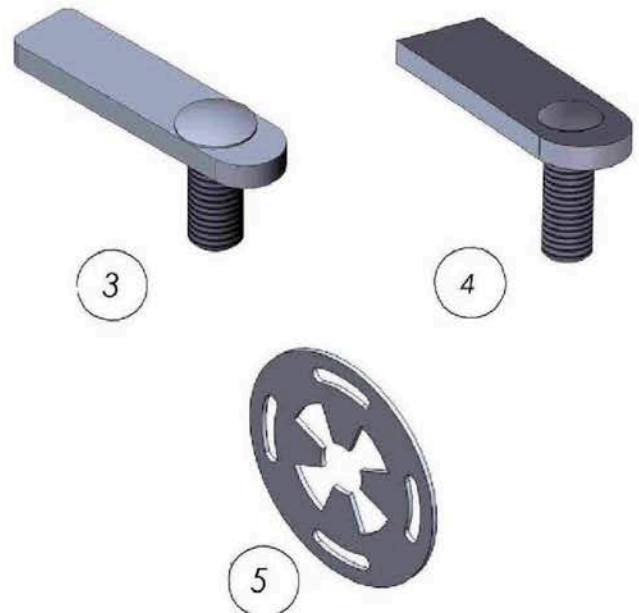

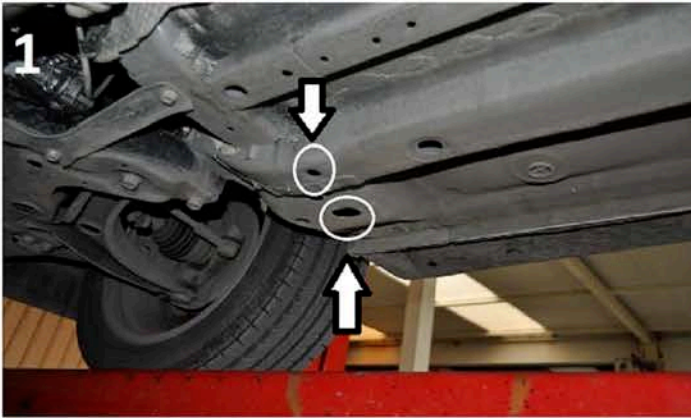

- 1) Locate front mounting area and remove rubber plugs as shown on image #1.
- 2) Install HTC 262 and HTC230 with HTC 269
- 3) Install front bracket as shown on image #2
- 4) Do not tighten anything yet and proceed to the rear bracket area.

WARNING: Do not use powertools.

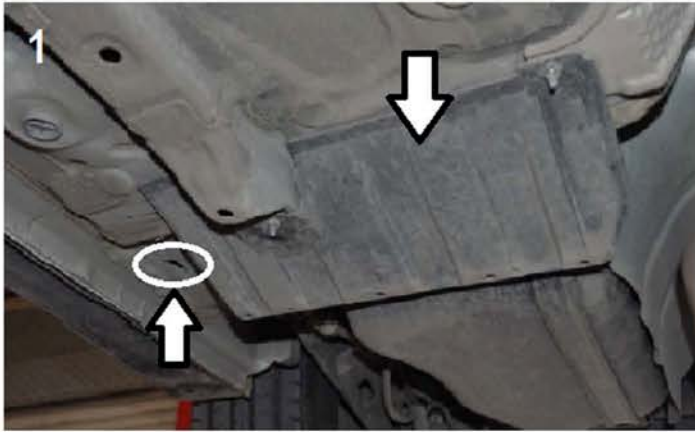
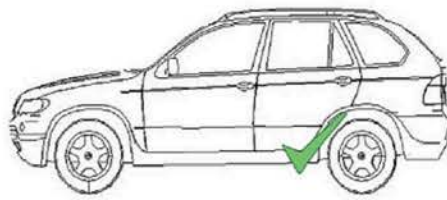

- 1) Locate rear mounting area and remove rubber plugs .
- 2) Remove vehicle rear plastic panels.
- 3) The back portion is attached to a factory mounting point. Remove the vehicle's bolt and use the bolt again after you install rear bracket. image #2
- 4) Install HTC 262 with HTC 269 for the front portion. image #3
- 5) Install rear bracket as shown on image #4
- 6) Loosen the M8 hardware on back of the steps and install onto brackets hand tight only
- 7) Tighten brackets hardware M10 to 35 ft lbs. **WARNING: Do not use powertools.**
- 8) Tighten steps M8 hardware to 18 ft lbs.

Repeat procedure on opposite side.

3125 - MITSUBISHI OUTLANDER 2013-PRESENT

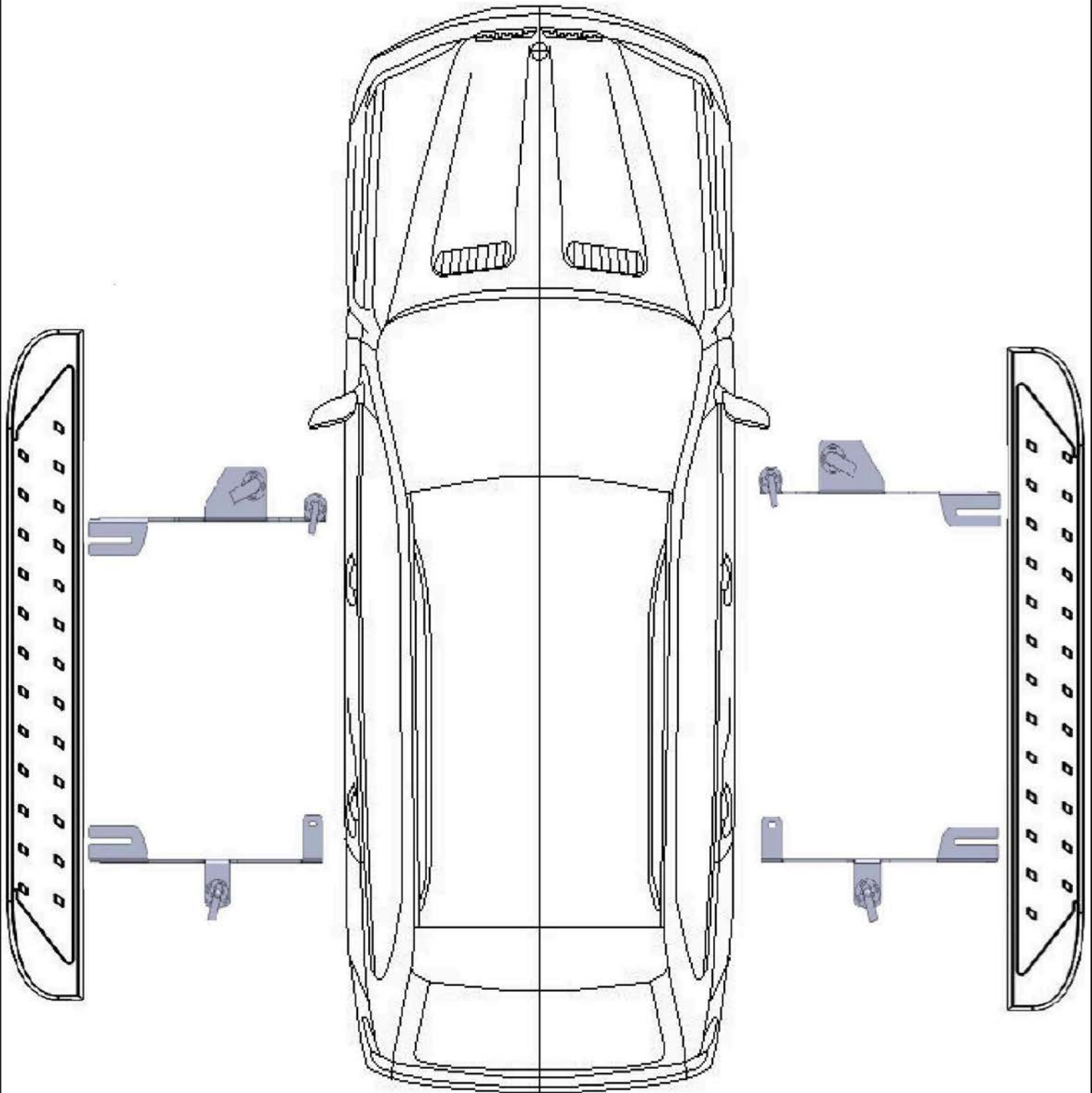

ATTENTION PLEASE! : DO NOT TIGHTEN ALL OF THE SCREWS UNTIL ALL OF THE PARTS ARE INSTALLED.

Keep your Romik accessories clean. To prevent corrosion and to maintain your high quality finish, wax or polish regularly with quality stainless polish. Use a non abrasive type automotive wax. Any use of abrasive soaps, polishes or waxes can be detrimental to the finish.

On our website you'll find a wide variety of high-quality [Running Boards & Step Bars](#) from [Romik](#).