



MOUNTING BRACKET KIT KIT# 521239-5

INSTALLATION INSTRUCTIONS

Important

Note: this bracket will not accommodate the Guardian rock shield, some models of the Tow Defender, Stowaway or the StowMaster and StowMaster All Terrain tow bars.

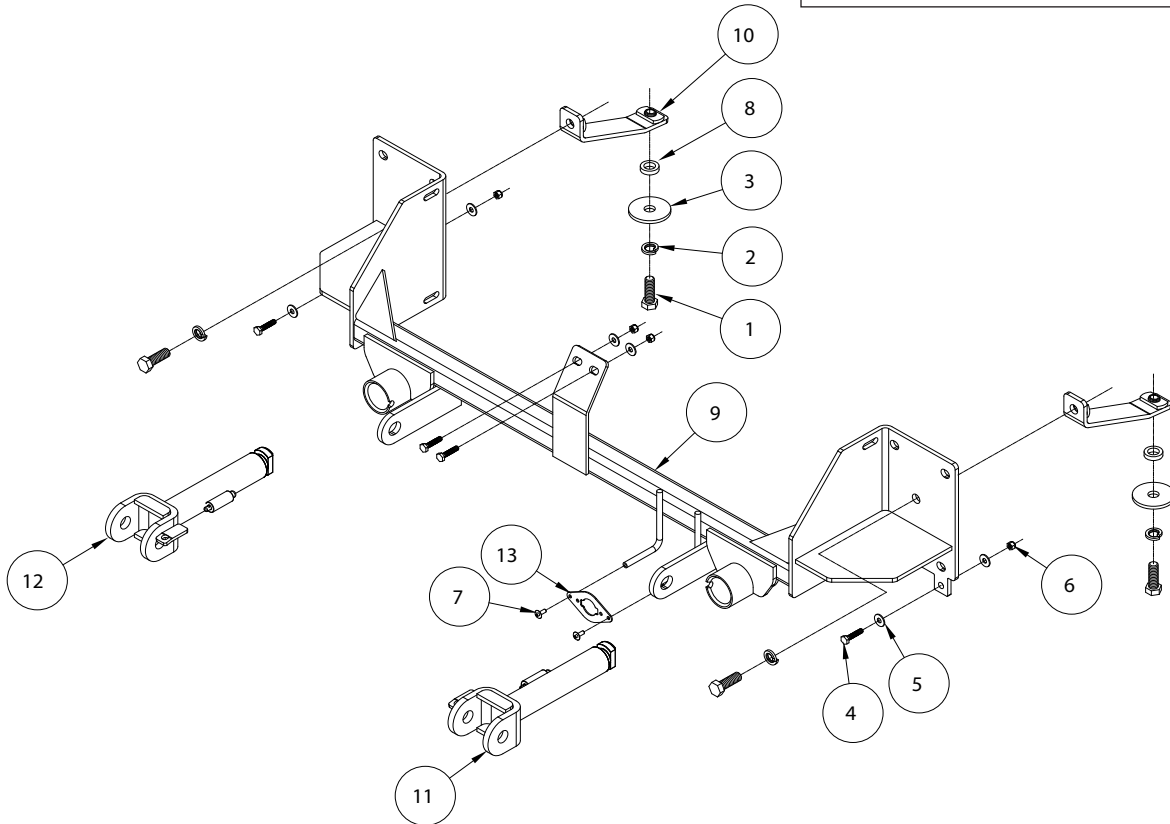

ITEM	QTY	NAME	PART#
1	4	1/2" x 1 1/2" BOLT	350095-00
2	4	1/2" LOCK WASHER	350309-00
3	2	1/2" PLATE WASHER	350354-00
4	4	6mm x 1.0 x 20mm BOLT	355750-00
5	6	1/4" FLAT WASHER	350300-00
6	4	6mm NYLON LOCKNUT	355760-00
7	2	#10 x 3/4" SELF TAPPING SCREW	350247-35
8	2	1" x 1/4" SPACER	A-001022
9	1	MAIN RECEIVER	C-002873
10	2	BRACE	C-002874
11	1	DRIVER SIDE ARM	C-002383
12	1	PASSENGER SIDE ARM	C-002384
13	1	WIRE PLUG PLATE	A-003801
14	2	ZIP TIE	300140-10



MOUNTING BRACKET KIT INSTALLATION INSTRUCTIONS

KIT# 521239-5

This is one of our EZ5 Twistlock series brackets, which allows the visible front portion of the bracket to be easily removed from the front of the vehicle (Fig.A and Fig.B). The bracket consists of a main receiver brace, two support brackets, two removable front braces, and a hardware pack.

The main receiver brace mounts to the frame and the bumper core mounts. The removable front braces install in the main receiver brace.

Before starting the installation, lay out the kit components in order, as they will be used. This will give you a visual idea of how the components work, and will also confirm that everything is present and accounted for.



IMPORTANT: All brackets **must** be assembled with all the bolts left loose for final adjustment and positioning (before tightening) unless otherwise instructed. All bolts **must** be torqued for proper strength. If more than one bolt is used per fastening point, the diagram may only show one.

- Use flat washers over all slotted holes
- Use lock washers on all fasteners

ROADMASTER Limited Warranty, including One-Year Conditional Warranty Text and Product Registration Card, in Carton.

WARNING

Failure to follow these instructions can result in property damage, personal injury or even death.

- Installation of most mounting brackets requires moderate mechanical aptitude and skills. We strongly recommend professional installation by an experienced installer.
- The installer must read the instructions and use all bolts and parts supplied. Failure to do so could result in loss of the towed vehicle.
- Use Loctite® Red on all bolts used for mounting this bracket.
- Every 3,000 miles, the owner must inspect the fasteners for proper torque, according to the bolt torque requirements chart on the last page of these instructions. The owner must also inspect all mounts and brackets for cracks or other signs of fatigue every 3,000 miles. Failure to do so could result in loss of the towed vehicle.
- The owner must check the vehicle manufacturer's instructions for the proper procedure(s) to prepare the vehicle for towing. Some vehicles must be equipped with a transmission lube pump, an axle disconnect, driveline disconnect or free-wheeling hubs before they can be towed. Failure to properly equip the vehicle will cause severe damage to the transmission.
- If running changes were made by the vehicle manufacturer after this bracket was designed, some bolts or other fasteners in the hardware pack may no longer be the correct size. It is the installer's responsibility to verify that the bracket is securely fastened to the vehicle and fitted with the correct hardware to account for these changes. Failure to securely fasten the bracket could result in loss of the towed vehicle.
- If the towed vehicle has been in an accident, it must be properly repaired before attaching the bracket. Do not install the bracket if any structural frame damage is found. Failure to repair the damage could result in the loss of the towed vehicle.

- Roadmaster manufactures many styles of brackets. If your bracket has removable arms, they must be removed before driving the vehicle, unless the arms can be pinned or padlocked in place. If not secured, the arms could vibrate out, resulting in non-warranty damage or personal injury.
- Some motorhome chassis have such a tight turning radius that you can damage your motorhome, towed vehicle, tow bar or bracket while turning sharply. Before getting on the road, test your turning radius in an empty parking lot. Turning too sharply could result in non-warranty damage to towing system, motorhome and/or towed vehicle.
- Do not back up with the towed vehicle attached or non-warranty damage will occur to your towing system, motorhome and/or towed vehicle.
- The safety cables must connect the towing vehicle to the towed vehicle frame to frame, with the cables crossed, with enough slack for sharp turns. Refer to the cable instructions for proper routing. Failure to leave enough slack in the safety cables, or failure to connect the safety cables frame to frame, will result in the loss of the towed vehicle.
- This bracket is designed for use with ROADMASTER tow bars and ROADMASTER adaptors only. Using this bracket with other brands, without an approved ROADMASTER adaptor, may result in non-warranty damage or injury.
- Do not use this document for custom fabrication, as it may not show all parts or structural components. Custom fabrication or an attempt to copy this bracket design could result in loss of the towed vehicle.
- Upon final installation, the installer must inspect the bracket to ensure adequate clearance, particularly around hoses, air conditioner lines, radiators, etc., or non-warranty damage to the towed vehicle will result.
- This bracket is only warranted for the original installation. Installing a used bracket on another vehicle is not recommended and will void the warranty.



MOUNTING BRACKET KIT INSTALLATION INSTRUCTIONS

KIT# 521239-5



1. **Important:** please use all supplied bolts and parts and read all instructions carefully before beginning this installation. The majority of questions you may have can be answered within the text, and proper installation will ensure safe and secure travel. Now, begin the installation by removing two T25 Torx screws attaching the upper grille to the core support (Fig.C). Now, firmly grip the upper grille and pull up to release the clips attaching it to the fascia (Fig.D). *Note:* take care not to break the clips at the corners of the grille.



2. Remove three T30 Torx bolts attaching the upper fascia to the core support (Fig.E).
3. On each side, remove four T20 Torx screws attaching the fascia to the fender liner and the fascia to the fender (Fig.F).
4. On each side, remove seven T27 Torx screws attaching the bottom of the fascia to the splash shielding (Fig.G).





MOUNTING BRACKET KIT INSTALLATION INSTRUCTIONS

KIT# 521239-5



5. Reach in behind the fascia and disconnect the fog lights, if the vehicle is so equipped. Then, on each side, locate the plastic tab indicated by the yellow arrow (Fig.H – passenger side). Pull out on the corners of the fasciato release the locking strips while releasing the tabs (Fig.I).

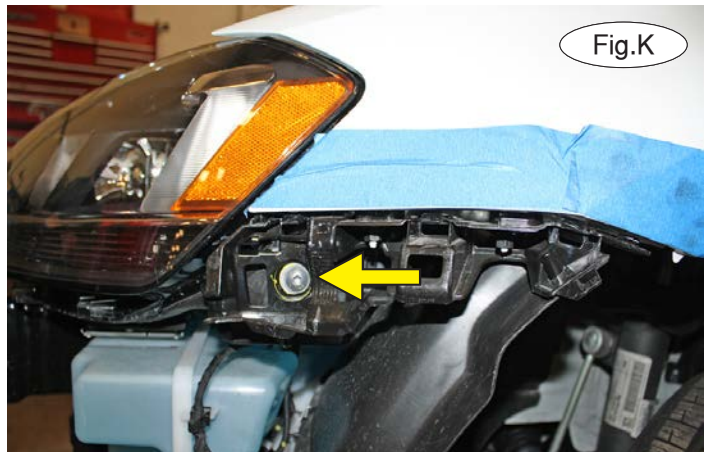

6. On each side, there are four T30 screws attaching each headlight to the frame. Remove three and loosen one (Fig.J, K and L – driver's side). Disconnect each headlight and set it aside for now.

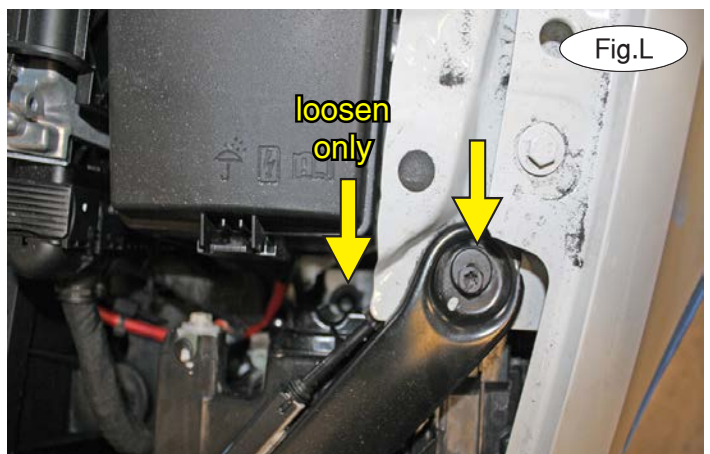



MOUNTING BRACKET KIT INSTALLATION INSTRUCTIONS

KIT# 521239-5

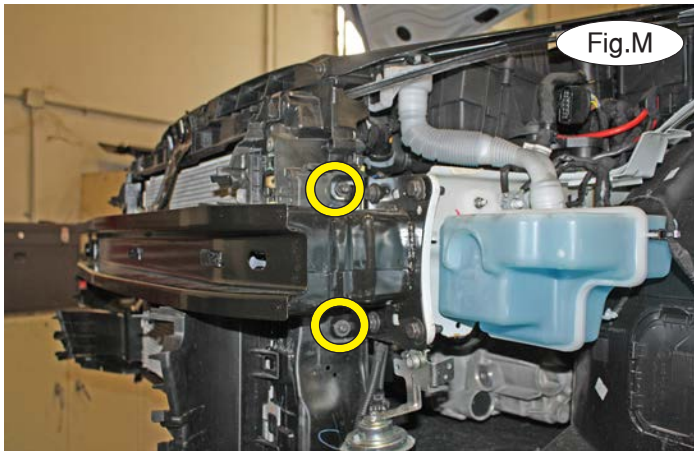

7. Support the core support with a jack stand. On each side, remove two T30 Torx bolts attaching the core support to the bumper (Fig.M).

8. On each side, use a pair of pliers to loosen and remove the horn mounting bolt (Fig.N). Disconnect the horns and move the horns out of the way for now.

9. Release the plastic clip attaching the ambient temperature sensor to the bumper core and then slide the ambient temperature sensor off its mount (Fig.O). Let it hang down, out of the way for now.

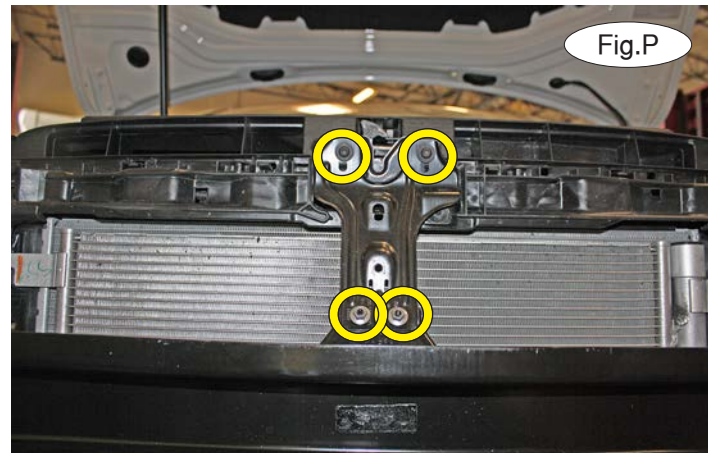

10. Remove two 10mm nuts and two T30 Torx bolts attaching the core support bracket to the bumper core (Fig.P). Set it aside for now.

11. On each side, remove four 16mm (head) bolts attaching the bumper core to the frame (Fig.Q). The bumper core will not be replaced. *Note:* retain the bumper core so that it can be replaced if the bracket is ever removed.

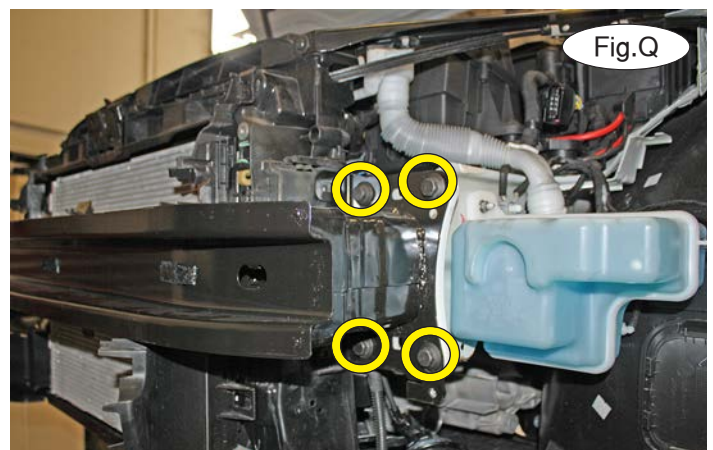



MOUNTING BRACKET KIT INSTALLATION INSTRUCTIONS

KIT# 521239-5

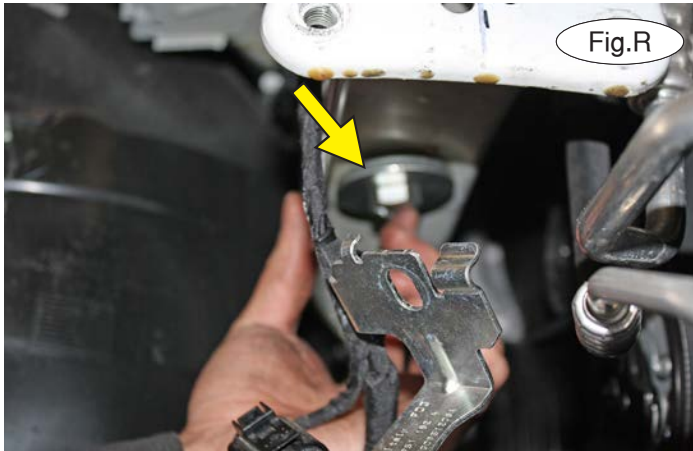

12. On each side, place a ½" plate washer over the supplied ½" x 1½" bolt and then add a 1" x .188 wall pipe spacer and bolt up through the rearmost hole in the bottom of the frame rail (Fig.R – passenger side). Then, place the support bracket in the end of the frame rail and over the bolt and finger tighten it (Fig.S – passenger side). **Note: ensure proper alignment, as the bolts will receive Loctite® Red and will be torqued at the end of these instructions.**



13. Trim the air deflectors as indicated with yellow lines (Fig.T).

14. Place the main receiver brace over the ends of the frame rails. Then, bolt through the center mounting point and into the support bracket on each side using a supplied ½" x 1½" bolt and ½" lock washer and replace the bumper core bolts you removed in step 11 (Fig.U).

15. Replace the core support bracket using the T30 Torx bolts from step 10 and the two supplied 6mm x 1.0 x 20mm bolts, two ¼" flat washers and 6mm Nylock nuts (Fig.V).





MOUNTING BRACKET KIT INSTALLATION INSTRUCTIONS

KIT# 521239-5

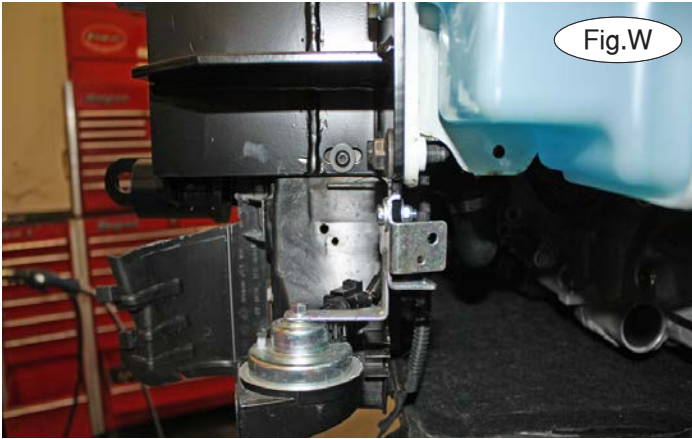

16. On each side, use the supplied 6mm x 1.0 x 20mm bolt, two 1/4" flat washers and 6mm Nylock nut to remount the horn mounting bracket (Fig.W).
17. Ziptie the ambient temperature sensor to the main receiver brace using the supplied zip ties (Fig.X).
18. Tighten all bolts to the bolt torque requirements found at the end of these instructions. **Note: use Loctite® Red on all nuts and bolts.**



19. Trim the fascia as shown in Figure Y to allow clearance for the main receiver brace.
20. Reverse steps 1 through 6 to reinstall the headlights and the fascia.
21. **Note: the following four images are for illustration purposes only, as your specific application may be slightly different.**

The spring-loaded pin on the removable arm snaps into a notch on the receiver, locking the removable arm into its final towing position. Before inserting each arm into the receiver, verify that the spring is working by ensuring that the spring-loaded pin moves easily back and forth within the barrel when pulled and that it can be pulled flush with the face of the barrel (Fig.Z and Fig.AA).





MOUNTING BRACKET KIT INSTALLATION INSTRUCTIONS

KIT# 521239-5

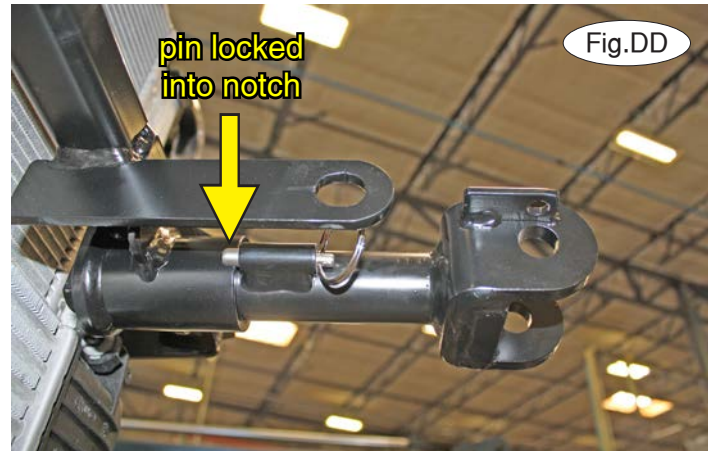
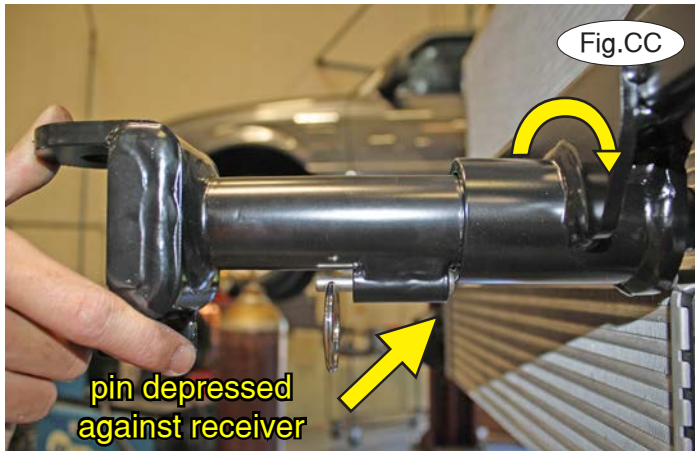

22. On each side, insert the removable front bracket arm into the front receiver 90 degrees from its final towing position, depressing the spring-loaded pin against the receiver (Fig.BB). Now, twist back 90 degrees until the spring-loaded pin snaps into place in the notch on the receiver, locking the arm into place in its final towing position (Fig.CC).

Please note: it is the owner's responsibility to ensure the locking of the pins before towing. Otherwise, failure of the towing system will result.

23. Install the tow bar to the mounting bracket according to the manufacturer's instructions.

IMPORTANT!

Safety cables are required by law. When towing, connect safety cables to the safety cable tabs illustrated on the first page and in Figure DD. Make certain there is adequate slack in the cables to allow a full turning radius; otherwise, damage will result. If necessary, longer cables or cable extensions are available.

Note: if the bracket is so equipped, the holes in the alignment tabs which are welded to the arms and main receiver braces are for padlocks only. Under no circumstances should you bolt the alignment tabs together. Bolting the alignment tabs together may result in non-warranty damage to the bracket.

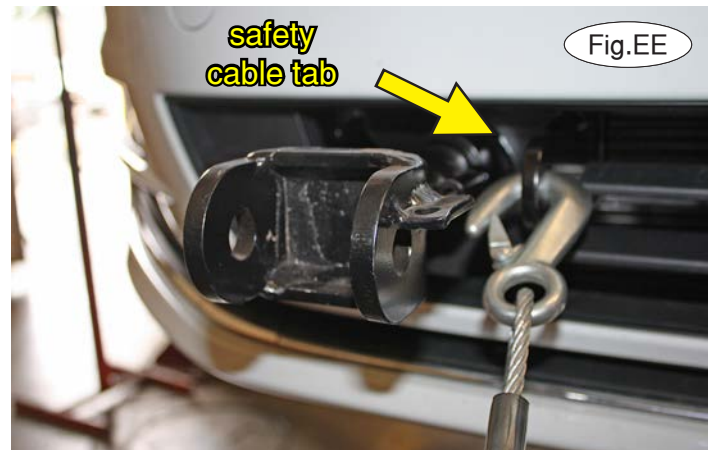



MOUNTING BRACKET KIT INSTALLATION INSTRUCTIONS

KIT# 521239-5

Three options for attaching the wiring plug to the main receiver brace

For six-wire plugs: use the two supplied $\frac{3}{4}$ " self-tapping screws to attach the electrical plug directly to the rods on the front of the main receiver brace.

For four-wire round plugs: attach to the plug mounting plate and then use the two supplied $\frac{3}{4}$ " self-tapping screws to attach the mounting plate to the rods on the front of the main receiver brace.

For four-wire flat plugs: place the plug through the mounting plug plate, and then secure it using the supplied zip tie on the front of the plug (Fig.EE). Use the two supplied $\frac{3}{4}$ " self-tapping screws to attach the mounting plate to the rods on the front of the main receiver brace.

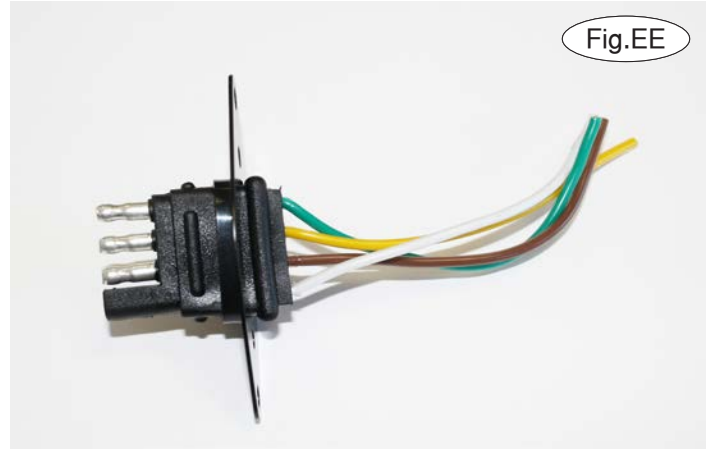

Fig.EE

BOLT TORQUE REQUIREMENTS

Note: The torque values represented below are intended as general guidelines. Torque requirements for specific applications may vary. Roadmaster does not warrant this information to be accurate for all applications and disclaims all liability for any claims or damages which may result from its use.

STANDARD BOLTS

Thread Size	Grade	Torque
5/16.....	5.....	13 ft./lb.
3/8.....	5.....	23 ft./lb.
7/16.....	5.....	37 ft./lb.
1/2.....	5.....	56 ft./lb.
5/8.....	5.....	150 ft./lb.

METRIC BOLTS

Thread Size	Grade	Plated / Unplated
8mm-1.0	8.8	20 ft./lb. 18 ft./lb.
8mm-1.25	8.8	19 ft./lb. 18 ft./lb.
10mm-1.25	8.8	38 ft./lb. 36 ft./lb.
10mm-1.5	8.8	37 ft./lb. 35 ft./lb.

METRIC BOLTS

Thread Size	Grade	Plated / Unplated
12mm-1.25	8.8	70 ft./lb. 65 ft./lb.
12mm-1.5	8.8	66 ft./lb. 61 ft./lb.
12mm-1.75	8.8	65 ft./lb. 60 ft./lb.
14mm-2.0	8.8	104 ft./lb. 97 ft./lb.