



MOUNTING BRACKET KIT INSTALLATION INSTRUCTIONS

KIT# 3177-3

Important

Note: this bracket will not accommodate the Guardian rock shield, some models of the Tow Defender, Stowaway or the StowMaster and StowMaster All Terrain tow bars.

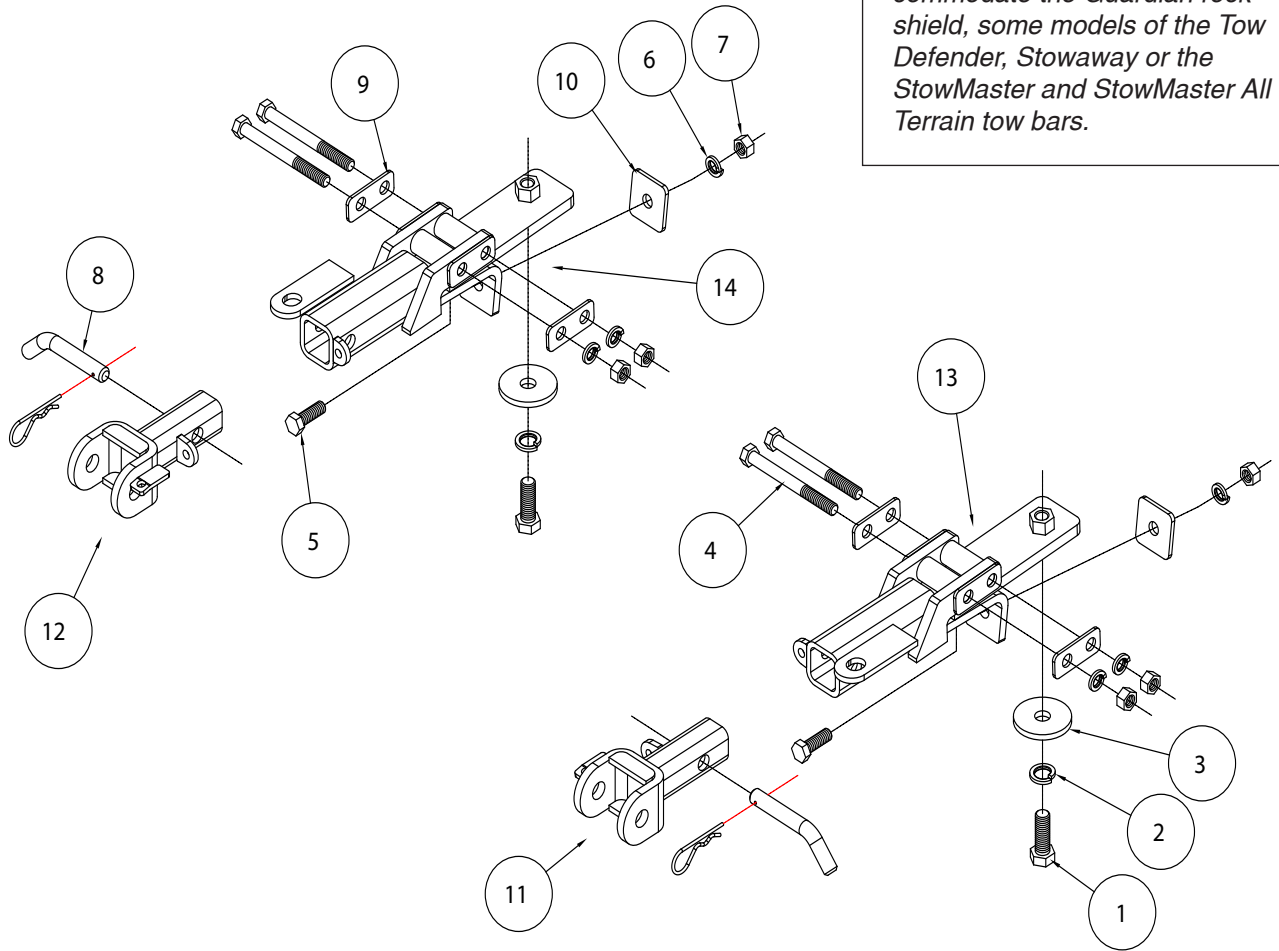

ITEM	QTY	NAME	PART #
1.....	2.....	5/8" x 2" BOLT.....	350150-00
2.....	2.....	5/8" LOCK WASHER.....	350313-00
3.....	2.....	5/8" PLATE WASHER.....	350352-00
4.....	4.....	1/2" x 5" BOLT.....	350107-00
5.....	2.....	1/2" x 1 1/2" BOLT.....	350095-00
6.....	6.....	1/2" LOCK WASHER.....	350305-00
7.....	6.....	1/2" HEX NUT.....	350258-00
8.....	2.....	DRAW PIN WITH CLIP.....	357035-00
9.....	4.....	1 1/8" x 2 3/4" BACKING PLATE.....	A-005218
10.....	2.....	3/16" x 2" x 2" BACKING PLATE.....	A-001066
11.....	1.....	DRIVER SIDE ARM.....	C-002595
12.....	1.....	PASSENGER SIDE ARM.....	C-002596
13.....	1.....	DRIVER SIDE RECEIVER.....	C-002648
14.....	1.....	PASSENGER SIDE RECEIVER.....	C-002649



MOUNTING BRACKET KIT INSTALLATION INSTRUCTIONS

KIT# 3177-3

This is one of our MX series brackets, which allows the visible front portion of the bracket to be easily removed from the front of the vehicle (Fig.A and Fig.B). The bracket consists of two main receiver braces, two removable front braces and a hardware pack.

The main receiver braces mount to the frame rails. The removable front braces install in the main receiver brace.

Before starting the installation, lay out the kit components in order, as they will be used. This will give you a visual idea of how the components work, and will also confirm that everything is present and accounted for.



IMPORTANT: All brackets **must** be assembled with all the bolts left loose for final adjustment and positioning (before tightening) unless otherwise instructed. All bolts **must** be torqued for proper strength. If more than one bolt is used per fastening point, the diagram may only show one.

- Use flat washers over all slotted holes
- Use lock washers on all fasteners

ROADMASTER Limited Warranty, including One-Year Conditional Warranty Text and Product Registration Card, in Carton.

WARNING

Failure to follow these instructions can result in property damage, personal injury or even death.

- Installation of most mounting brackets requires moderate mechanical aptitude and skills. We strongly recommend professional installation by an experienced installer.
- The installer must read the instructions and use all bolts and parts supplied. Failure to do so could result in loss of the towed vehicle.
- Use Loctite® Red on all bolts used for mounting this bracket.
- Every 3,000 miles, the owner must inspect the fasteners for proper torque, according to the bolt torque requirements chart on the last page of these instructions. The owner must also inspect all mounts and brackets for cracks or other signs of fatigue every 3,000 miles. Failure to do so could result in loss of the towed vehicle.
- The owner must check the vehicle manufacturer's instructions for the proper procedure(s) to prepare the vehicle for towing. Some vehicles must be equipped with a transmission lube pump, an axle disconnect, driveline disconnect or free-wheeling hubs before they can be towed. Failure to properly equip the vehicle will cause severe damage to the transmission.
- If running changes were made by the vehicle manufacturer after this bracket was designed, some bolts or other fasteners in the hardware pack may no longer be the correct size. It is the installer's responsibility to verify that the bracket is securely fastened to the vehicle and fitted with the correct hardware to account for these changes. Failure to securely fasten the bracket could result in loss of the towed vehicle.
- If the towed vehicle has been in an accident, it must be properly repaired before attaching the bracket. Do not install the bracket if any structural frame damage is found. Failure to repair the damage could result in the loss of the towed vehicle.
- Roadmaster manufactures many styles of brackets. If your bracket has removable arms, they must be removed before driving the vehicle, unless the arms can be pinned or padlocked in place. If not secured, the arms could vibrate out, resulting in non-warranty damage or personal injury.
- Some motorhome chassis have such a tight turning radius that you can damage your motorhome, towed vehicle, tow bar or bracket while turning sharply. Before getting on the road, test your turning radius in an empty parking lot. Turning too sharply could result in non-warranty damage to towing system, motorhome and/or towed vehicle.
- Do not back up with the towed vehicle attached or non-warranty damage will occur to your towing system, motorhome and/or towed vehicle.
- The safety cables must connect the towing vehicle to the towed vehicle frame to frame, with the cables crossed, with enough slack for sharp turns. Refer to the cable instructions for proper routing. Failure to leave enough slack in the safety cables, or failure to connect the safety cables frame to frame, will result in the loss of the towed vehicle.
- This bracket is designed for use with ROADMASTER tow bars and ROADMASTER adaptors only. Using this bracket with other brands, without an approved ROADMASTER adaptor, may result in non-warranty damage or injury.
- Do not use this document for custom fabrication, as it may not show all parts or structural components. Custom fabrication or an attempt to copy this bracket design could result in loss of the towed vehicle.
- Upon final installation, the installer must inspect the bracket to ensure adequate clearance, particularly around hoses, air conditioner lines, radiators, etc., or non-warranty damage to the towed vehicle will result.
- This bracket is only warranted for the original installation. Installing a used bracket on another vehicle is not recommended and will void the warranty.



MOUNTING BRACKET KIT INSTALLATION INSTRUCTIONS

KIT# 3177-3



1. **Important:** please use all supplied bolts and parts and read all instructions carefully before beginning this installation. The majority of questions you may have can be answered within the text, and proper installation will ensure safe and secure travel. Now, begin the installation. On each side, remove one 7mm (head) screw and one T15 (head) screw attaching the center fascia trim to the fender liner (Fig.C). *Note:* 2016 and later models may have an additional T15 screw to remove. Now, pull out on the trim and remove one 7mm (head) screw (Fig.D).

2. Release six clips attaching the center fascia trim to the back of the grille. Four of the six clips are shown in Figure E (passenger side). Pull out on the corner of the fascia while pulling down on the black tab on each clip to remove the center fascia trim.

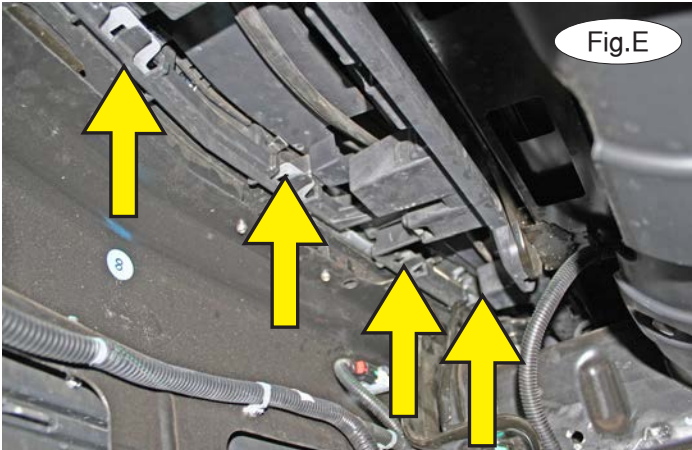

3. Remove four 10mm (head) bolts from the bottom of the grille (Fig.F).

4. On each side, remove 6 plastic fasteners attaching the radiator cover to the core support (Fig.G – passenger side).





MOUNTING BRACKET KIT INSTALLATION INSTRUCTIONS

KIT# 3177-3

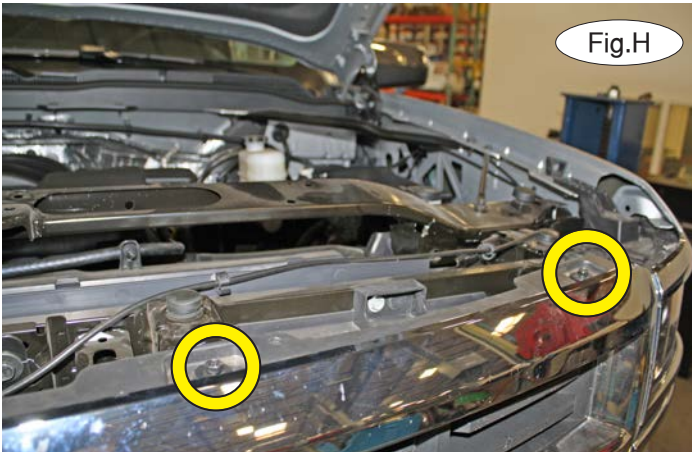

5. On each side, remove two 10mm (head) bolts attaching the top of the grille to the core support (Fig.H).
6. Carefully pull on the lower corner of the grille to release it from the locking clip (Fig.I – passenger side).



7. On each side, remove one 15mm (head) bolt attaching the bumper to the stabilizer bar (Fig.J – passenger side).
8. On the passenger side only, disconnect the wiring harness (Fig.K).
9. On each side, remove two 18mm (head) bolts attaching the bumper to the frame (Fig.L – passenger side). Now, remove the bumper. *Note:* this step will require two people due to the weight of the bumper.

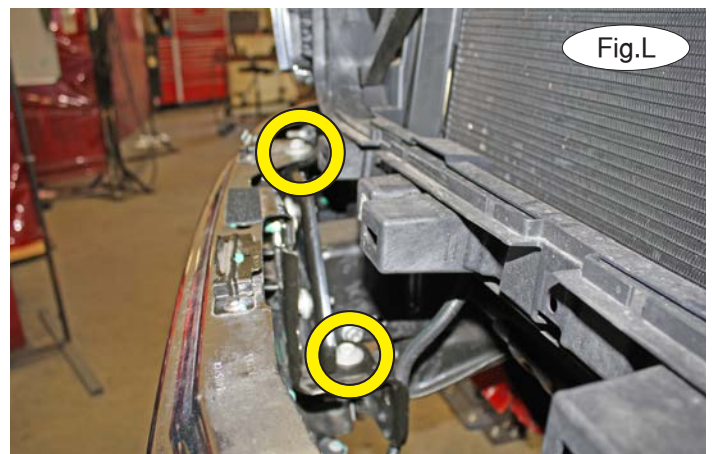



MOUNTING BRACKET KIT INSTALLATION INSTRUCTIONS

KIT# 3177-3

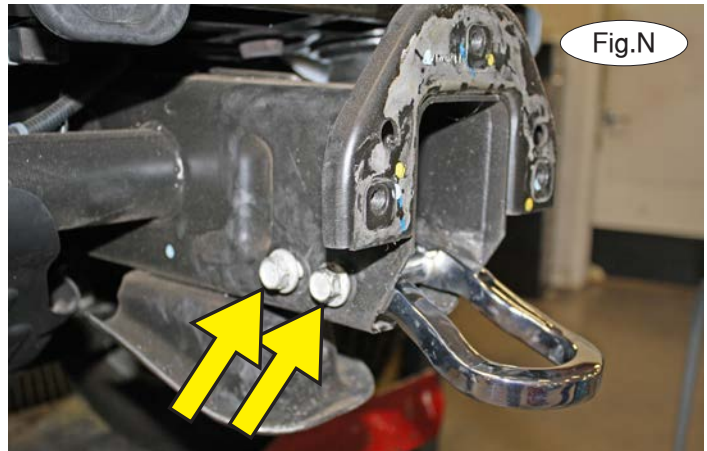
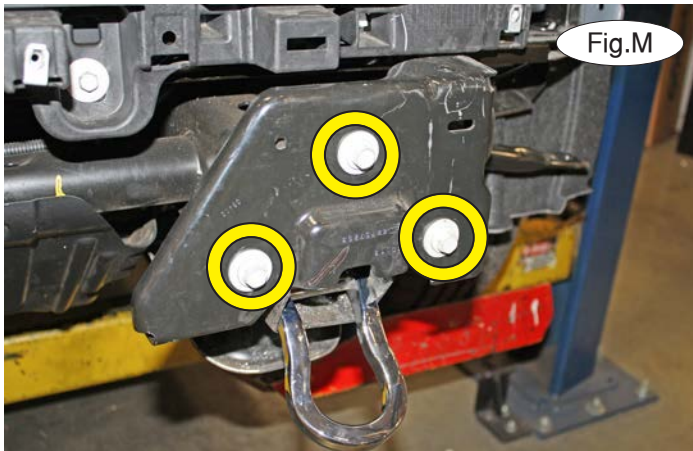

10. On the driver's side only, remove three 15mm (head) bolts attaching the bumper mounting plate to the frame rail (Fig.M).

11. On each side, remove one 18mm (head) bolt and nut, and one 18mm (head) bolt attaching the tow hook to the frame rail (Fig.N).



12. Working on one side at a time, insert the driver's side main receiver brace into the tow hook opening, and onto the front of the frame rail. *Note:* ensure that the safety cable tab is to the outside of the vehicle (Fig.O).

13. Attach the main receiver brace to the bottom of the frame rail by bolting one of the supplied 5/8" x 2" bolts, lock washers and plate washers through the existing hole at the bottom of the frame and into the existing weld nut in the main receiver brace (Fig.P). *Note:* ensure proper alignment, as the bolts will receive Loctite® Red and will be torqued at the end of these instructions.

14. On the outside of the frame rail, insert one of the supplied 1/2" x 5" bolts through one of the 1/4" x 1 1/4" x 2 3/4" backing plates (with two 9/16" holes) and into the existing hole at the front of the driver's side frame rail, which was used to attach the tow hook (Fig.Q). *Note:* due to manufacturing variances, this hole may need to be enlarged.

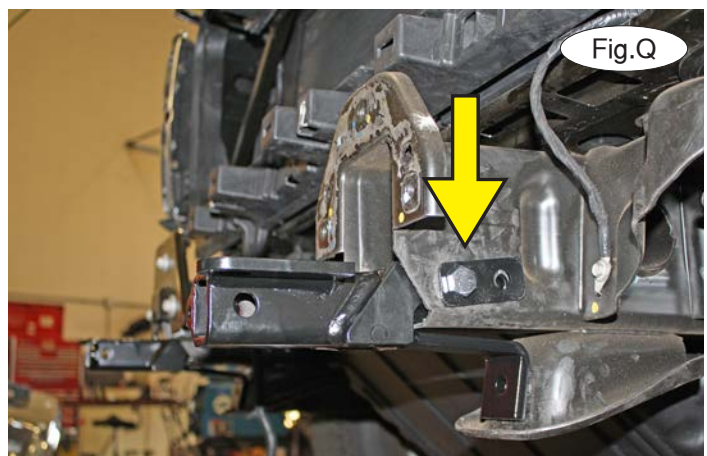



MOUNTING BRACKET KIT INSTALLATION INSTRUCTIONS

KIT# 3177-3



Fig.R



Fig.S

15. Using the pre-existing hole on the inside of the frame rail and the hole in the main receiver brace as a template, drill a 17/32" hole through the interior side of the frame rail and out through the backing plate you installed in the previous step (Fig.R).

16. From the outside of the frame rail, insert another 1/2" x 5" bolt through the backing plate and the hole you drilled in the previous step. On the inside of the frame rail, position another 1/4" x 1 1/4" x 2 3/4" backing plate (with two 9/16" holes) over the bolts. Then, attach the backing plate with two 1/2" lock washers and nuts (Fig.S).



Fig.T

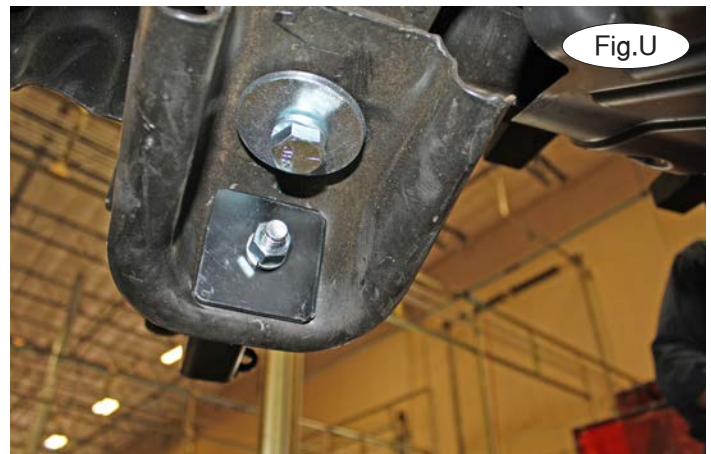

Fig.U

17. Using the lower hole in the main receiver brace as a template, drill a 17/32" hole through the lower frame reinforcement (Fig.T).

18. Now, using one of the supplied 1/2" x 1 1/2" bolts, bolt through the brace and the hole drilled in the lower frame reinforcement in the previous step. Finish with a 3/16" x 2" x 2" backing plate and 1/2" lock washer and nut (Fig.U).

19. **For 2016 and later models only:** trim the fascia on each side as shown in Figure V.



Fig.V



MOUNTING BRACKET KIT INSTALLATION INSTRUCTIONS

KIT# 3177-3

20. *Note:* use the drawing on page 1 as a guide to ensure the bracket is centered on the car and that the attachment points for the quick-disconnects are 28½" from center to center. Tighten all bolts to the bolt torque requirements found at the end of these instructions. *Note:* use Loctite® Red on all nuts and bolts.

21. Reinstall the fascia, bumper and bumper mounting plate, reversing steps 1 through 10. *Note:* ensure that the bumper aligns on top of the stabilizer bar when reversing step 7.

22. Insert the removable front bracket arms into the front receiver braces.

23. Install the tow bar to the mounting bracket according to the manufacturer's instructions. Attach the ends of the safety cables to the tow vehicle's safety cable tab and the tow bar.

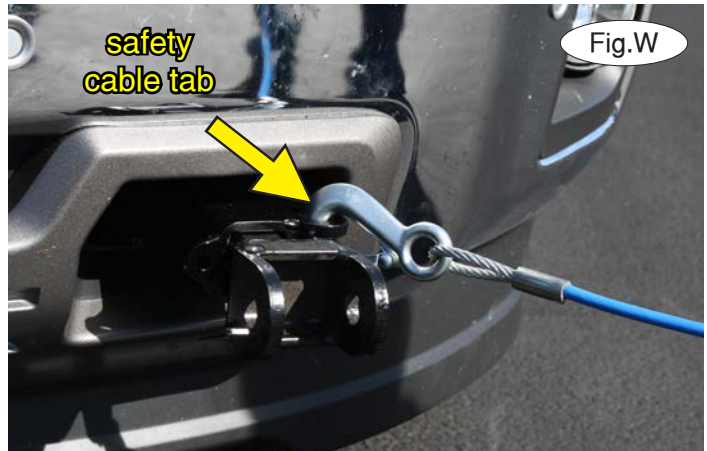

Fig.W

IMPORTANT!

Safety cables are required by law. When towing, connect safety cables to the safety cable tabs shown in Figure W. Make certain there is adequate slack in the cables to allow a full turning radius; otherwise, damage will result. If necessary, longer cables or cable extensions are available.

Note: if the bracket is so equipped, the holes in the alignment tabs which are welded to the arms and main receivers are for padlocks only. Under no circumstances should you bolt the alignment tabs together. Bolting the alignment tabs together may result in non-warranty damage to the bracket.



Fig.X

Three options for attaching the wiring plug to the main receiver brace

For six-wire plugs: use the two supplied ¾" self-tapping screws to attach the electrical plug directly to the rods on the front of the main receiver brace.

For four-wire round plugs: attach to the plug mounting plate and then use the two supplied ¾" self-tapping screws to attach the mounting plate to the rods on the front of the main receiver brace.

For four-wire flat plugs: place the plug through the mounting plug plate, and then secure it using the supplied zip tie on the front of the plug (Fig.X). Use the two supplied ¾" self-tapping screws to attach the mounting plate to the rods on the front of the main receiver brace.

BOLT TORQUE REQUIREMENTS

Note: The torque values represented below are intended as general guidelines. Torque requirements for specific applications may vary. Roadmaster does not warrant this information to be accurate for all applications and disclaims all liability for any claims or damages which may result from its use.

STANDARD BOLTS

Thread Size	Grade	Torque
5/16.....	5.....	13 ft./lb.
3/8.....	5.....	23 ft./lb.
7/16.....	5.....	37 ft./lb.
1/2.....	5.....	56 ft./lb.
5/8.....	5.....	150 ft./lb.

METRIC BOLTS

Thread Size	Grade	Plated / Unplated
8mm-1.0	8.8	20 ft./lb. 18 ft./lb.
8mm-1.25	8.8	19 ft./lb. 18 ft./lb.
10mm-1.25	8.8	38 ft./lb. 36 ft./lb.
10mm-1.5	8.8	37 ft./lb. 35 ft./lb.

METRIC BOLTS

Thread Size	Grade	Plated / Unplated
12mm-1.25	8.8	70 ft./lb. 65 ft./lb.
12mm-1.5	8.8	66 ft./lb. 61 ft./lb.
12mm-1.75	8.8	65 ft./lb. 60 ft./lb.
14mm-2.0	8.8	104 ft./lb. 97 ft./lb.