

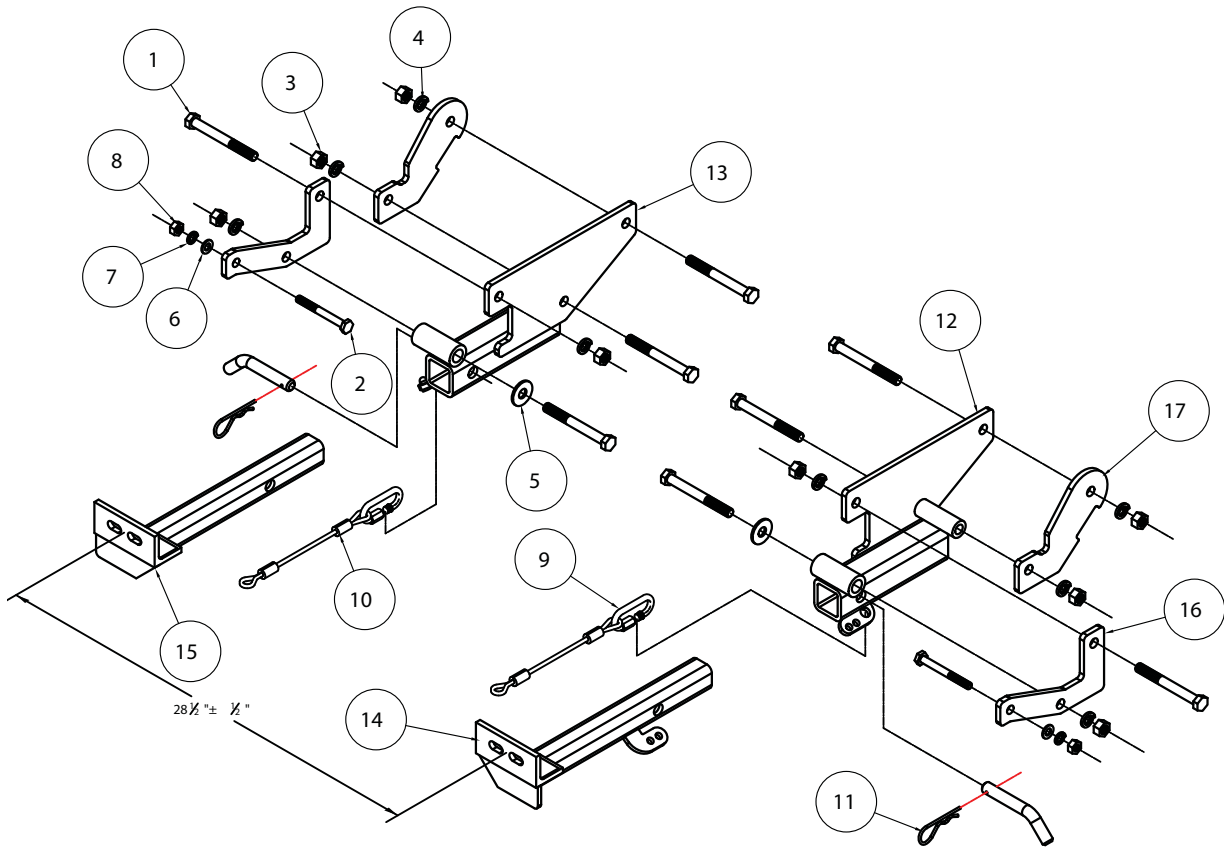

# MOUNTING BRACKET KIT INSTALLATION INSTRUCTIONS

**KIT# 3122-1**



Item	Qty.	Description	Part No.
1.....	8.....	1/2" x 4 1/2" BOLT.....	350106-00
2.....	2.....	10mm x 1.5 x 90mm BOLT.....	356115-00
3.....	8.....	1/2" NUT.....	350258-00
4.....	8.....	1/2" LOCK WASHER.....	350309-00
5.....	2.....	1/2" FLAT WASHER.....	350308-20
6.....	2.....	10mm FLAT WASHER.....	355710-00
7.....	2.....	10mm LOCK WASHER.....	355715-00
8.....	2.....	10mm x 1.5 NUT.....	356230-00
9.....	2.....	CABLE CONNECTORS.....	200008-00
10.....	2.....	10" SAFETY CABLES.....	650646-10
11.....	2.....	DRAW PIN/SPRING PIN.....	357035-00
12.....	1.....	DRIVER SIDE RECEIVER.....	C-000803
13.....	1.....	PASSENGER SIDE RECEIVER.....	C-000804
14.....	1.....	DRIVER SIDE ARM.....	C-000805
15.....	1.....	PASSENGER SIDE ARM.....	C-000806
16.....	2.....	FRONT MOUNTING PLATE.....	A-001432
17.....	2.....	REAR MOUNTING PLATE.....	A-001433



# MOUNTING BRACKET KIT INSTALLATION INSTRUCTIONS

**KIT# 3122-1**

This is one of our XL series brackets, which allows the visible front portion of the bracket to be easily removed from the front of the vehicle (Fig.A and Fig.B). The bracket consists of two main receiver braces, two front support braces, two rear support braces, two removable front braces, and a hardware pack.

The main receiver brace mounts to the frame rails; the front and rear support braces mount to the frame rails and the main receiver brace.

Before starting the installation, lay out the kit components in order, as they will be used. This will give you a visual idea of how the components work, and will also confirm that everything is present and accounted for.



**IMPORTANT:** All brackets **must** be assembled with all the bolts left loose for final adjustment and positioning (before tightening) unless otherwise instructed. All bolts **must** be torqued for proper strength. If more than one bolt is used per fastening point, the diagram may only show one.

- Use flat washers over all slotted holes
- Use lock washers on all fasteners

ROADMASTER Limited Warranty, including One-Year Conditional Warranty Text and Product Registration Card, in Carton.

## WARNING

Failure to follow these instructions can result in property damage, personal injury or even death.

- Installation of most mounting brackets requires moderate mechanical aptitude and skills. We strongly recommend professional installation by an experienced installer.
- The installer must read the instructions and use all bolts and parts supplied. Failure to do so could result in loss of the towed vehicle.
- Use Loctite® Red on all bolts used for mounting this bracket.
- Every 3,000 miles, the owner must inspect the fasteners for proper torque, according to the bolt torque requirements chart on the last page of these instructions. The owner must also inspect all mounts and brackets for cracks or other signs of fatigue every 3,000 miles. Failure to do so could result in loss of the towed vehicle.
- The owner must check the vehicle manufacturer's instructions for the proper procedure(s) to prepare the vehicle for towing. Some vehicles must be equipped with a transmission lube pump, an axle disconnect, driveline disconnect or free-wheeling hubs before they can be towed. Failure to properly equip the vehicle will cause severe damage to the transmission.
- If running changes were made by the vehicle manufacturer after this bracket was designed, some bolts or other fasteners in the hardware pack may no longer be the correct size. It is the installer's responsibility to verify that the bracket is securely fastened to the vehicle and fitted with the correct hardware to account for these changes. Failure to securely fasten the bracket could result in loss of the towed vehicle.
- If the towed vehicle has been in an accident, it must be properly repaired before attaching the bracket. Do not install the bracket if any structural frame damage is found. Failure to repair the damage could result in the loss of the towed vehicle.

- Roadmaster manufactures many styles of brackets. If your bracket has removable arms, they must be removed before driving the vehicle, unless the arms can be pinned or padlocked in place. If not secured, the arms could vibrate out, resulting in non-warranty damage or personal injury.
- Some motorhome chassis have such a tight turning radius that you can damage your motorhome, towed vehicle, tow bar or bracket while turning sharply. Before getting on the road, test your turning radius in an empty parking lot. Turning too sharply could result in non-warranty damage to towing system, motorhome and/or towed vehicle.
- Do not back up with the towed vehicle attached or non-warranty damage will occur to your towing system, motorhome and/or towed vehicle.
- The safety cables must connect the towing vehicle to the towed vehicle frame to frame, with the cables crossed, with enough slack for sharp turns. Refer to the cable instructions for proper routing. Failure to leave enough slack in the safety cables, or failure to connect the safety cables frame to frame, will result in the loss of the towed vehicle.
- This bracket is designed for use with ROADMASTER tow bars and ROADMASTER adaptors only. Using this bracket with other brands, without an approved ROADMASTER adaptor, may result in non-warranty damage or injury.
- Do not use this document for custom fabrication, as it may not show all parts or structural components. Custom fabrication or an attempt to copy this bracket design could result in loss of the towed vehicle.
- Upon final installation, the installer must inspect the bracket to ensure adequate clearance, particularly around hoses, air conditioner lines, radiators, etc., or non-warranty damage to the towed vehicle will result.
- This bracket is only warranted for the original installation. Installing a used bracket on another vehicle is not recommended and will void the warranty.



# MOUNTING BRACKET KIT INSTALLATION INSTRUCTIONS

**KIT# 3122-1**



1. **Important:** please use all supplied bolts and parts and read all instructions carefully before beginning this installation. The majority of questions you may have can be answered within the text, and proper installation will ensure safe and secure travel. Now, begin the installation. On each side, remove one 13mm (head) bolt attaching the splash shield to the frame (Fig.C). Remove the splash shield (Fig.D).

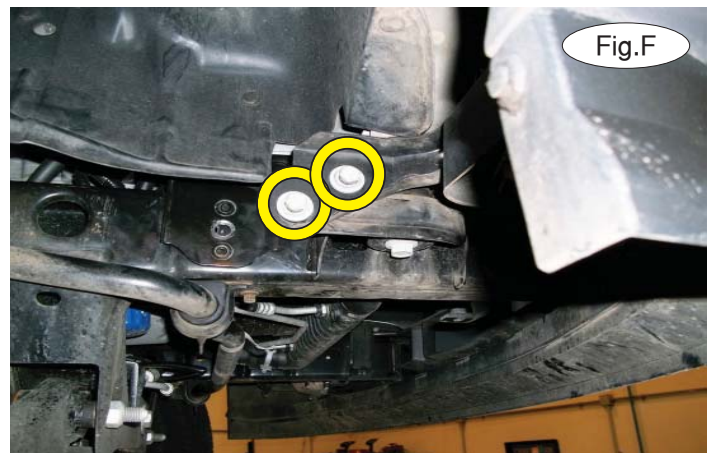
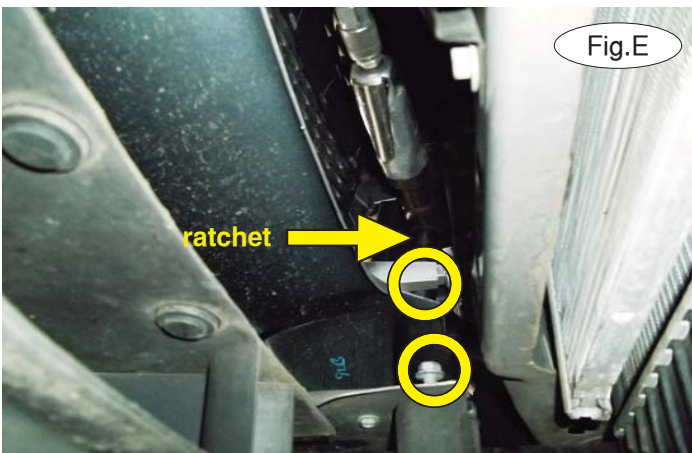

2. On the back side of the fascia, remove four 15mm (head) bolts with a deep socket ratchet (Fig.E – driver's side).

3. On each side, remove two 10mm (head) bolts attaching the bumper to the frame rail (Fig.F) and remove the bumper.

4. Pull out and forward to remove the bumper. Disconnect the fog lights, if the vehicle is so equipped.

5. On each side, remove two 18mm (head) bolts and nuts attaching the tow hook to the frame (Fig.G). The tow hooks will not be replaced. *Note:* retain the tow hooks and their attachment hardware for replacement in case the bracket is ever removed.





# MOUNTING BRACKET KIT INSTALLATION INSTRUCTIONS

**KIT# 3122-1**

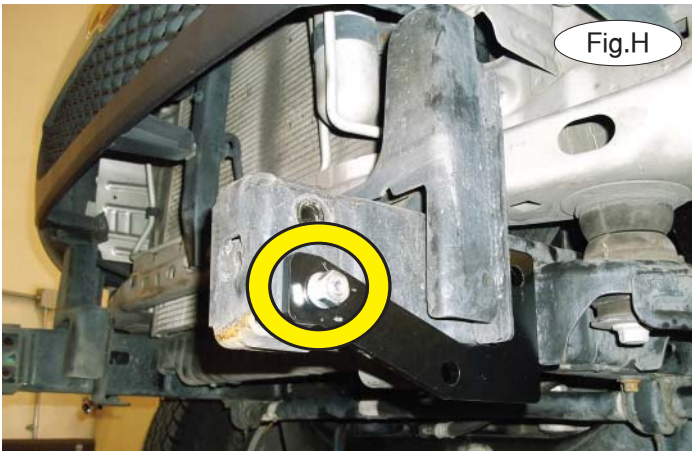

6. Working on the driver's side only, use one of the 10mm x 1.5 x 90mm bolts to bolt through the inside of the frame rail. Place the forwardmost hole of the front support brace over the bolt and finish with a 10mm lock washer and 10mm x 1.5 nut (Fig.H). *Note:* ensure proper alignment, as the bolts will receive Loctite® Red and will be torqued at the end of these instructions.

7. Place the main receiver brace to the inside of the frame rail, aligning the upper forwardmost hole of the brace with the pre-existing hole in the frame rail. Use a 1/2" x 4 1/2" bolt and bolt through the main receiver brace, inside of the frame rail and through the upper rearmost hole of the front support brace. Finish with a 1/2" lock washer and nut (Fig.I).

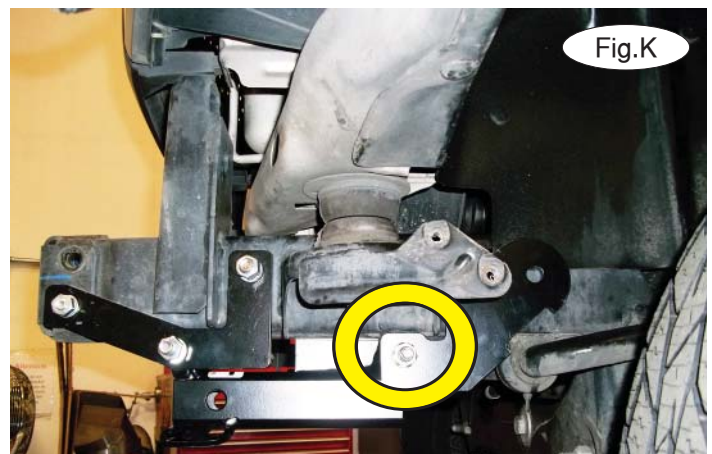

8. Place a 1/2" washer over a 1/2" x 4 1/2" bolt and bolt through the front pipe spacer of the main receiver brace and the bottom hole in the front support brace. Finish with a 1/2" lock washer and nut (Fig.J).

9. Use a 1/2" x 4 1/2" bolt and bolt through the lower rearmost hole of the main receiver brace and into the lower hole of the rear support brace. Finish with a 1/2" lock washer and nut (Fig.K).

10. Rotate the rear support brace up until it is level with the frame rail (Fig.L).

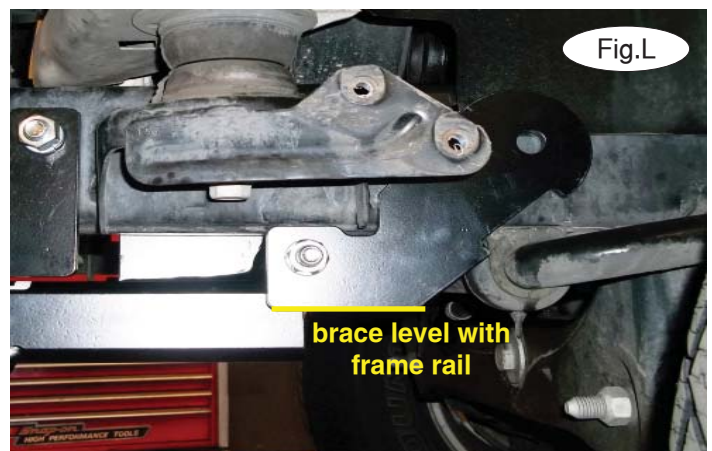



# MOUNTING BRACKET KIT INSTALLATION INSTRUCTIONS

**KIT# 3122-1**



Fig.M



Fig.N

11. Using the rearmost hole of the rear support brace as a template, drill a  $\frac{1}{2}$ " hole through the inside of the frame rail (Fig.M). *Note:* use caution so you only drill through the outside layer of the frame rail to avoid drilling into the radiator hose.

12. Now, place a  $\frac{1}{2}$ " x  $4\frac{1}{2}$ " bolt through the rearmost hole of the rear support brace, frame rail and main receiver brace. Finish with a  $\frac{1}{2}$ " lock washer and nut (Fig.N).

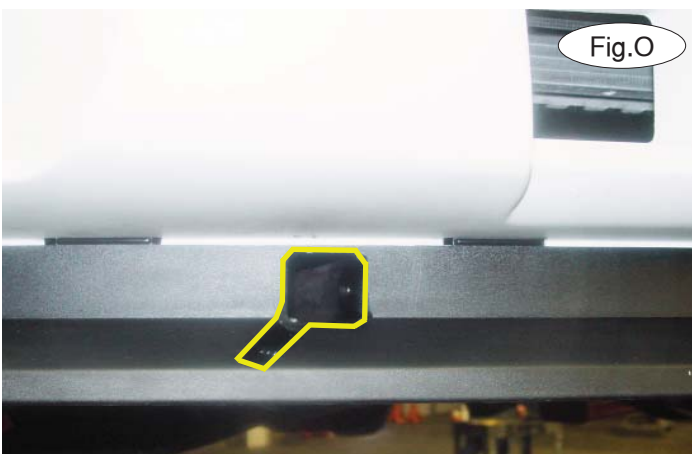

Fig.O

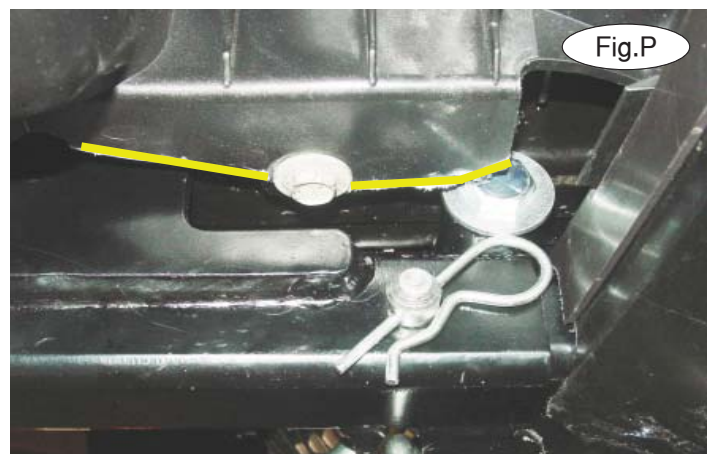

Fig.P

13. Repeat steps 6 through 12 for the passenger side. *Note:* if the vehicle is equipped with an auxiliary air pump, complete steps 6 through 9 and then proceed to the supplemental instructions found at the end of this document, which will replace steps 10 through 12.

14. Using the drawing on the first page as a reference, measure between the two front braces, ensuring that the distance is  $28" \pm \frac{1}{2}"$ .

15. Tighten all bolts to the bolt torque requirements found at the end of these instructions. *Note:* use Loctite® Red on all nuts and bolts.

16. Hold the fascia in place over the main receiver braces and trim using the yellow lines in Figure O as a reference for trimming. Now, reinstall the bumper, reversing steps 2 through 4.

17. Trim the splash guard you removed in step 1 to allow clearance for the main receiver brace. Reinstall the splash guard, reversing step 1 (Fig.P).



# MOUNTING BRACKET KIT INSTALLATION INSTRUCTIONS

**KIT# 3122-1**

18. Install the front arms and secure with 5/8" draw pins and 3/16" spring pins. Recheck the measurements, to make certain this distance is still 28" +/- 1/2". Attach the 10" safety cables with the cable connectors (Q-Links) to the front of the receiver braces (Fig.Q).

19. Attach the ends of the safety cables to the tow vehicle's safety cables and tow bar. Install the tow bar to the mounting bracket according to the manufacturer's instructions.

*Note:* if the bracket is so equipped, the holes in the alignment tabs which are welded to the arms and main receiver braces are for padlocks only. Under no circumstances should you bolt the alignment tabs together. Bolting the alignment tabs together may result in non-warranty damage to the bracket.



Fig.Q

## BOLT TORQUE REQUIREMENTS

Note: The torque values represented below are intended as general guidelines. Torque requirements for specific applications may vary. Roadmaster does not warrant this information to be accurate for all applications and disclaims all liability for any claims or damages which may result from its use.

### STANDARD BOLTS

Thread Size	Grade	Torque
5/16	5	13 ft./lb.
3/8	5	23 ft./lb.
7/16	5	37 ft./lb.
1/2	5	56 ft./lb.
5/8	5	150 ft./lb.

### METRIC BOLTS

Thread Size	Grade	Plated / Unplated
8mm-1.0	8.8	20 ft./lb. 18 ft./lb.
8mm-1.25	8.8	19 ft./lb. 18 ft./lb.
10mm-1.25	8.8	38 ft./lb. 36 ft./lb.
10mm-1.5	8.8	37 ft./lb. 35 ft./lb.

### METRIC BOLTS

Thread Size	Grade	Plated / Unplated
12mm-1.25	8.8	70 ft./lb. 65 ft./lb.
12mm-1.5	8.8	66 ft./lb. 61 ft./lb.
12mm-1.75	8.8	65 ft./lb. 60 ft./lb.
14mm-2.0	8.8	104 ft./lb. 97 ft./lb.

All illustrations and specifications contained herein are based on the latest information available at the time of publication approval. ROADMASTER, INC. reserves the right to make changes at any time without notice in material, specification and models or to discontinue models.



# MOUNTING BRACKET KIT INSTALLATION INSTRUCTIONS

**KIT# 3122-1**

## Auxiliary Air Pump Supplemental Instructions



1. On the outside of the frame rail, rotate the rear support brace over the air pump mounting plate until it's level with the frame (Fig.A).
2. Using the rearmost hole of the rear support brace as a template, drill a  $\frac{1}{2}$ " hole through the air pump mounting bracket and the outside of the frame rail. *Note:* use caution so you only drill through the outside layer of the frame rail to avoid drilling into the radiator hose.
3. Place the air pump mounting bracket on top of the rear support brace and then place a  $\frac{1}{2}$ " x  $4\frac{1}{2}$ " bolt through the air pump mounting bracket, rearmost hole of the rear support brace, frame rail and main receiver brace. Finish with a  $\frac{1}{2}$ " lock washer and nut (Fig.B).

Now, proceed to step 14 in the main instructions.