

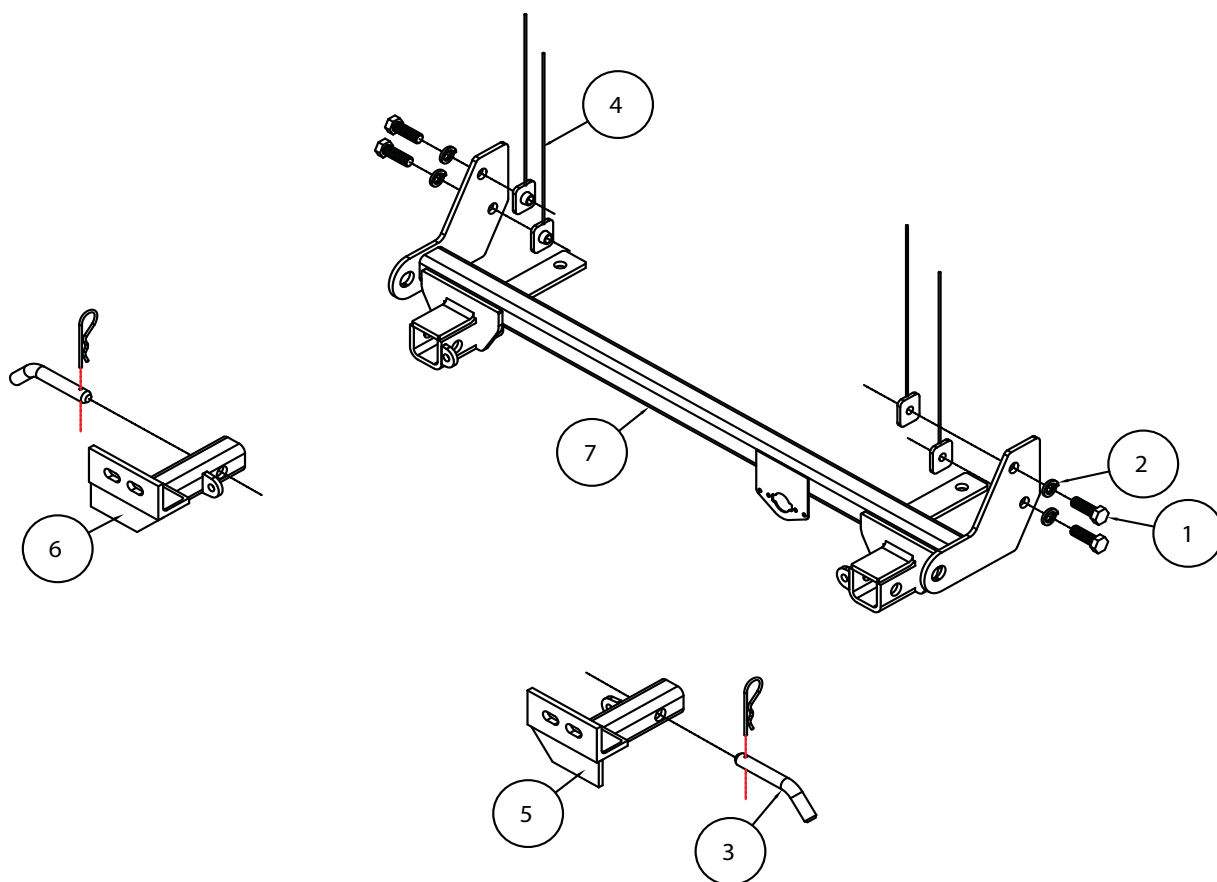

# MOUNTING BRACKET KIT INSTALLATION INSTRUCTIONS

KIT# 1444-1

**Special Tools Needed**  
Cut off wheel or die grinder



ITEM	QTY	NAME	PART #
1.....	4.....	1/2" x 1 1/2" BOLT .....	350095-00
2.....	4.....	1/2" LOCK WASHER.....	350309-00
3.....	2.....	5/8" DRAW PIN W/ CLIP .....	357035-00
4.....	4.....	3/16" x 1 1/4" x 2 1/2" THREADED BACKING PLATE W/ 10" ROD .....	C-001416
5.....	1.....	DRIVER SIDE ARM .....	C-002592
6.....	1.....	PASSENGER SIDE ARM.....	C-002593
7.....	1.....	MAIN RECEIVER .....	C-002594



# MOUNTING BRACKET KIT INSTALLATION INSTRUCTIONS

**KIT# 1444-1**

This is one of our XL series brackets, which allows the visible front portion of the bracket to be easily removed from the front of the vehicle (Fig.A and Fig.B). The bracket consists of a main receiver brace, two removable front braces, and a hardware pack.

The main receiver brace mounts to the sub-frame and the two removable front braces fit into the main receiver brace.

Before starting the installation, lay out the kit components in order, as they will be used. This will give you a visual idea of how the components work, and will also confirm that everything is present and accounted for.



Fig.A



Fig.B

**IMPORTANT:** All brackets *must* be assembled with all the bolts left loose for final adjustment and positioning (before tightening) unless otherwise instructed. All bolts *must* be torqued for proper strength. If more than one bolt is used per fastening point, the diagram may only show one.

- Use flat washers over all slotted holes
- Use lock washers on all fasteners

ROADMASTER Limited Warranty, including One-Year Conditional Warranty Text and Product Registration Card, in Carton.



## WARNING

Failure to follow these instructions can result in property damage, personal injury or even death.

- **Installation of most mounting brackets requires moderate mechanical aptitude and skills.** We strongly recommend professional installation by an experienced installer.
- **The installer must read the instructions and use all bolts and parts supplied.** Failure to do so could result in loss of the towed vehicle.
- **Use Loctite® Red** on all bolts used for mounting this bracket.
- **Every 3,000 miles, the owner must inspect the fasteners** for proper torque, according to the bolt torque requirements chart on the last page of these instructions. **The owner must also inspect all mounts and brackets for cracks or other signs of fatigue every 3,000 miles.** Failure to do so could result in loss of the towed vehicle.
- **The owner must check the vehicle manufacturer's instructions for the proper procedure(s) to prepare the vehicle for towing.** Some vehicles must be equipped with a transmission lube pump, an axle disconnect, driveline disconnect or free-wheeling hubs before they can be towed. Failure to properly equip the vehicle will cause severe damage to the transmission.
- **If running changes were made** by the vehicle manufacturer after this bracket was designed, some bolts or other fasteners in the hardware pack may no longer be the correct size. **It is the installer's responsibility** to verify that the bracket is securely fastened to the vehicle and fitted with the correct hardware to account for these changes. Failure to securely fasten the bracket could result in loss of the towed vehicle.
- If the towed vehicle has been in an accident, it must be properly repaired before attaching the bracket. **Do not install the bracket if any structural frame damage is found.** Failure to repair the damage could result in the loss of the towed vehicle.
- Roadmaster manufactures many styles of brackets. **If your bracket has removable arms, they must be removed before driving the vehicle, unless the arms can be pinned or padlocked in place.** If not secured, the arms could vibrate out, resulting in non-warranty damage or personal injury.
- Some motorhome chassis have such a tight turning radius that you can damage your motorhome, towed vehicle, tow bar or bracket while turning sharply. **Before getting on the road, test your turning radius in an empty parking lot.** Turning too sharply could result in non-warranty damage to towing system, motorhome and/or towed vehicle.
- **Do not back up with the towed vehicle attached** or non-warranty damage will occur to your towing system, motorhome and/or towed vehicle.
- **The safety cables must connect the towing vehicle to the towed vehicle frame to frame, with the cables crossed, with enough slack for sharp turns.** Refer to the cable instructions for proper routing. Failure to leave enough slack in the safety cables, or failure to connect the safety cables frame to frame, will result in the loss of the towed vehicle.
- This bracket is designed for use with ROADMASTER tow bars and ROADMASTER adaptors only. **Using this bracket with other brands, without an approved ROADMASTER adaptor, may result in non-warranty damage or injury.**
- **Do not use this document for custom fabrication,** as it may not show all parts or structural components. Custom fabrication or an attempt to copy this bracket design could result in loss of the towed vehicle.
- Upon final installation, **the installer must inspect the bracket to ensure adequate clearance, particularly around hoses, air conditioner lines, radiators, etc.,** or non-warranty damage to the towed vehicle will result.
- **This bracket is only warranted for the original installation.** Installing a used bracket on another vehicle is not recommended and will void the warranty.





# MOUNTING BRACKET KIT INSTALLATION INSTRUCTIONS

**KIT# 1444-1**

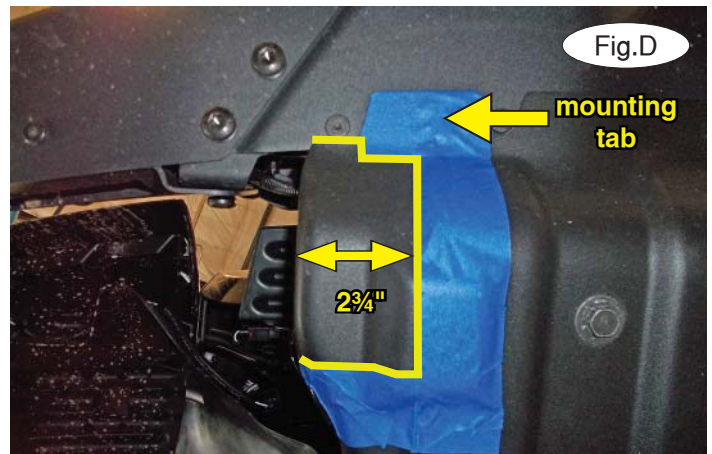
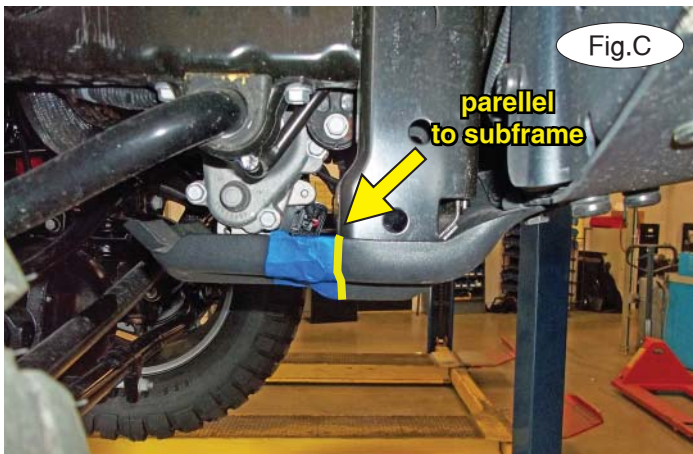

1. **Important:** please use all supplied bolts and parts and read all instructions carefully before beginning this installation. The majority of questions you may have can be answered within the text, and proper installation will ensure safe and secure travel. Now, begin the installation. Using tape or a marker, indicate the front corners of the skid plate for trimming, in a line parallel with the back of the subframe (Fig.C). Measure over 2 $\frac{3}{4}$ " from the edge of the skid plate and mark, leaving enough material for the mounting tab (Fig.D). Now, trim the skid plate. Figure E shows the completed trimming. Before moving onto step 2, check that the threaded backing plate with rod can easily fit into the end of the subframe (Fig.F). If it can't, trim the skid plate until it can.

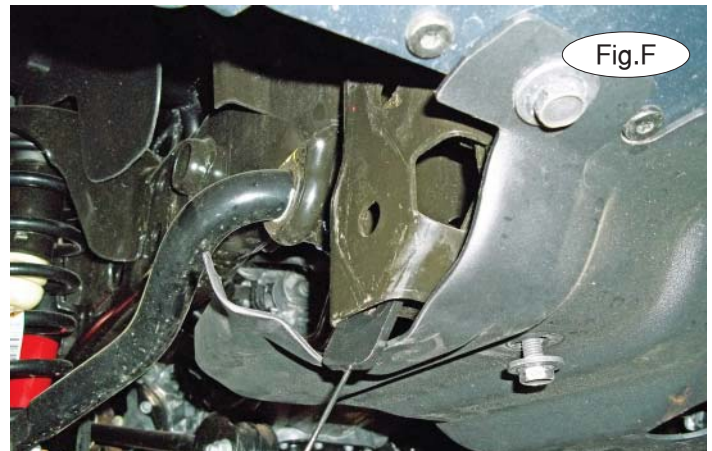

2. On each side, remove the rear 15mm (head) skidplate bolt. Place the main receiver brace around the subframe and then replace the 15mm (head) bolt, bolting through the main receiver brace, skid plate and into the subframe (Fig.G – driver's side).







# MOUNTING BRACKET KIT INSTALLATION INSTRUCTIONS

**KIT# 1444-1**

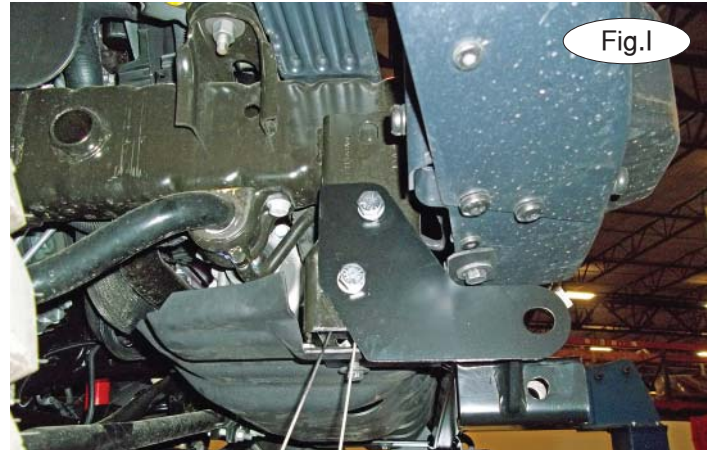
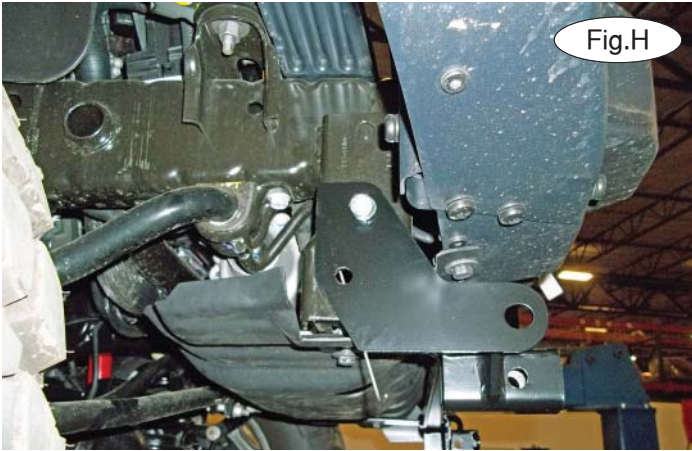

3. On each side, align the holes in the main receiver brace with the holes in the side of the subframe. Now, slide one of the 3/16" x 1 1/4" x 2 1/2" threaded backing plates with rod into the end of the subframe, aligning it with the uppermost hole. Using one of the 1/2" lock washers and 1/2" x 1 1/2" bolts, bolt through the main receiver brace, subframe and into the threaded backing plate with rod (Fig.H). *Note:* ensure proper alignment, as the bolts will receive Loctite® Red and will be torqued at the end of these instructions.

4. On each side, repeat step 3 for the lowermost hole (Fig.I).



5. Tighten all bolts to the bolt torque requirements found at the end of these instructions. *Note:* use Loctite® Red on all nuts and bolts.

6. Use a pair of pliers to break the wires off the backing plates (Fig.J).

7. Insert the removable front braces into the main receiver braces (Fig.K). Secure them in place with the supplied 5/8" draw pins and spring pins.

8. Attach the safety cables (Fig.L).

9. Install the tow bar to the mounting bracket according to the manufacturer's instructions.

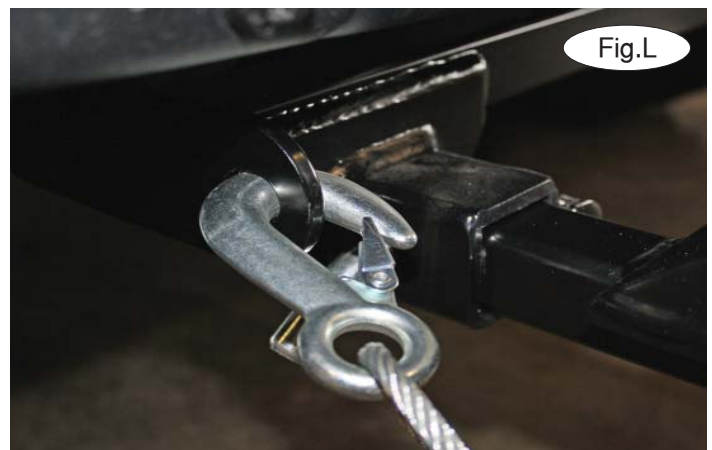



# MOUNTING BRACKET KIT INSTALLATION INSTRUCTIONS

**KIT# 1444-1**

**IMPORTANT!**

**Safety cables are required by law. When towing, connect safety cables to the safety cable tabs illustrated on page 1. Make certain there is adequate slack in the cables to allow a full turning radius; otherwise, damage will result. If necessary, longer cables or cable extensions are available.**

*Note:* if the bracket is so equipped, the holes in the alignment tabs which are welded to the arms and main receiver braces are for padlocks only. Under no circumstances should you bolt the alignment tabs together. Bolting the alignment tabs together may result in non-warranty damage to the bracket.

### Three options for attaching the wiring plug to the main receiver brace

**For six-wire plugs:** use the two supplied 3/4" self-tapping screws to attach the electrical plug directly to the rods on the front of the main receiver brace.

**For four-wire round plugs:** attach to the plug mounting plate and then use the two supplied 3/4" self-tapping screws to attach the mounting plate to the rods on the front of the main receiver brace.

**For four-wire flat plugs:** place the plug through the mounting plug plate, and then secure it using the supplied zip tie on the front of the plug (Fig.M). Use the two supplied 3/4" self-tapping screws to attach the mounting plate to the rods on the front of the main receiver brace.

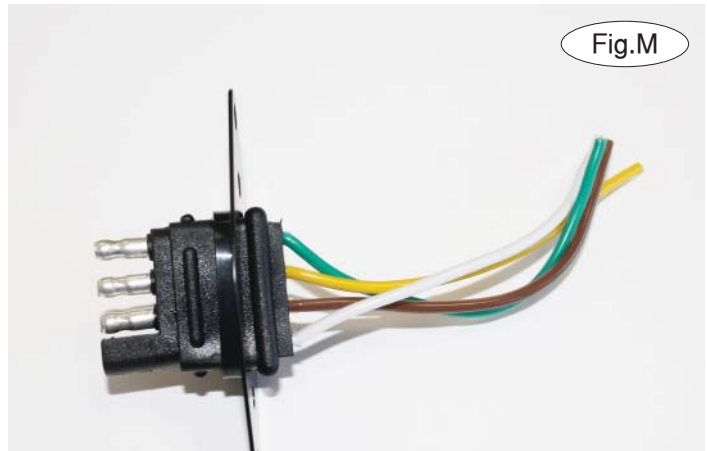

### BOLT TORQUE REQUIREMENTS

Note: The torque values represented below are intended as general guidelines. Torque requirements for specific applications may vary. Roadmaster does not warrant this information to be accurate for all applications and disclaims all liability for any claims or damages which may result from its use.

#### STANDARD BOLTS

Thread Size	Grade	Torque
5/16.....	5.....	13 ft./lb.
3/8.....	5.....	23 ft./lb.
7/16.....	5.....	37 ft./lb.
1/2.....	5.....	56 ft./lb.
5/8.....	5.....	150 ft./lb.

#### METRIC BOLTS

Thread Size	Grade	Plated / Unplated
8mm-1.0 .....	8.8 .....	20 ft./lb. 18 ft./lb.
8mm-1.25 .....	8.8 .....	19 ft./lb. 18 ft./lb.
10mm-1.25 .....	8.8 .....	38 ft./lb. 36 ft./lb.
10mm-1.5 .....	8.8 .....	37 ft./lb. 35 ft./lb.

#### METRIC BOLTS

Thread Size	Grade	Plated / Unplated
12mm-1.25 .....	8.8 .....	70 ft./lb. 65 ft./lb.
12mm-1.5 .....	8.8 .....	66 ft./lb. 61 ft./lb.
12mm-1.75 .....	8.8 .....	65 ft./lb. 60 ft./lb.
14mm-2.0 .....	8.8 .....	104 ft./lb. 97 ft./lb.

All illustrations and specifications contained herein are based on the latest information available at the time of publication approval. ROADMASTER, INC. reserves the right to make changes at any time without notice in material, specification and models or to discontinue models.