

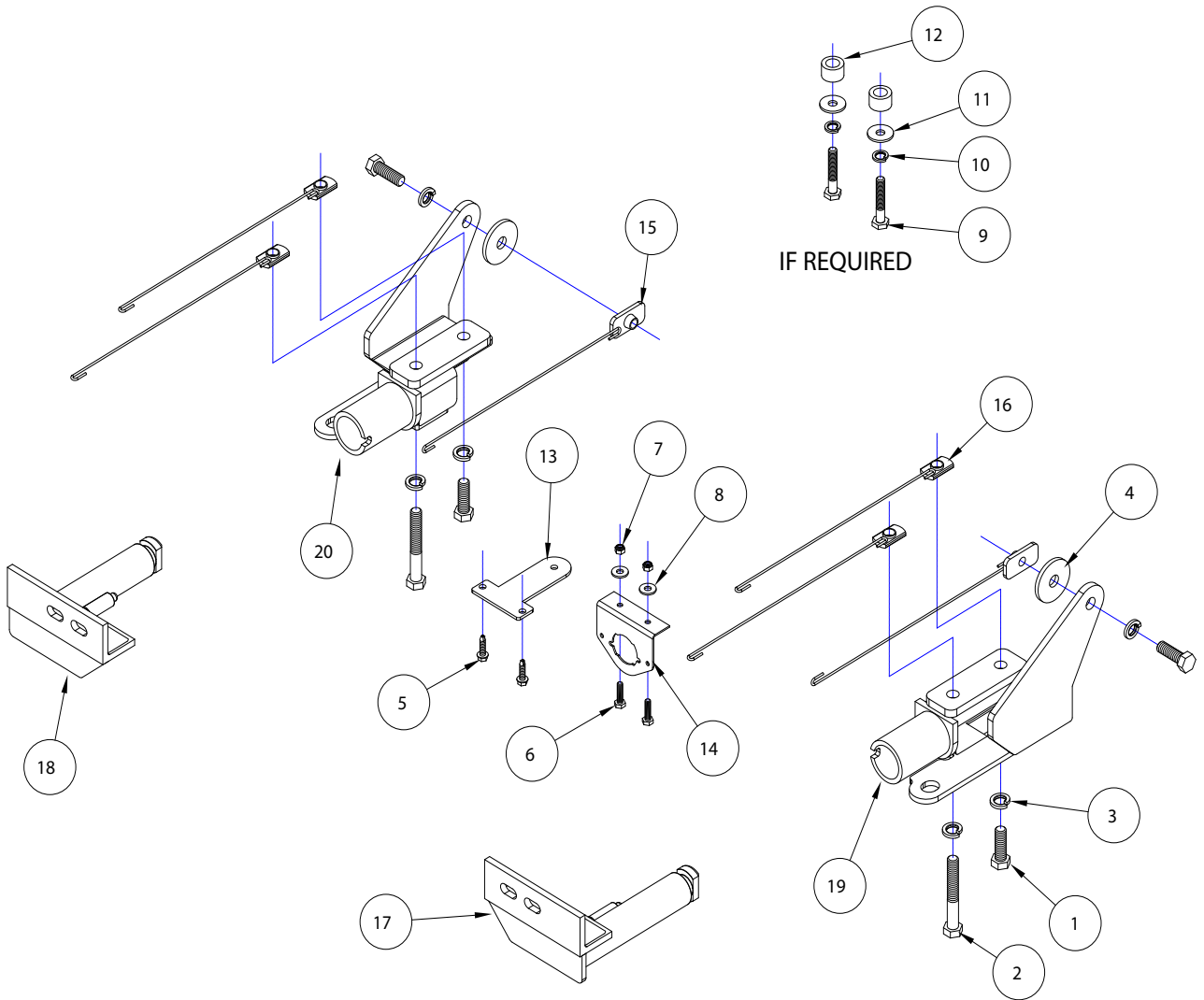

BASEPLATE KIT INSTALLATION INSTRUCTIONS

KIT# 524431-4

ROADMASTER, Inc.



ITEM	QTY	NAME	PART #
1	4	1/2" x 1 1/2" BOLT	350095-00
2	2	1/2" x 3 1/2" BOLT	350103-00
3	6	1/2" LOCK WASHER	350309-00
4	2	1/2" PLATE WASHER	350354-00
5	2	1/4" x 3/4" SELF TAPPING SCREW	357250-00
6	2	6mm x 1.0 x 20mm BOLT	355750-00
7	2	6mm x 1.0 NYLOCK NUT	355760-00
8	2	1/4" FLAT WASHER	350300-00
9	2	10mm x 1.5 x 55mm BOLT	356106-00
10	2	10mm LOCK WASHER	355715-00
11	2	3/8" FLAT WASHER	350304-00
12	2	1" O.D. x 0.188 WALL x 5/8" TUBE SPACER	A-000156
13	1	BRAKEAWAY BRACKET	A-005376
14	1	WIRE PLUG PLATE	B-000045
15	2	1" x 2" THREADED BACKING PLATE WITH 12" ROD	C-002439
16	4	1/2" TAB WELDNUT WITH 12" ROD	C-002852
17	1	DRIVER SIDE ARM	C-003079
18	1	PASSENGER SIDE ARM	C-003080
19	1	DRIVER SIDE RECEIVER	C-003081
20	1	PASSENGER SIDE RECEIVER	C-003082



BASEPLATE KIT INSTALLATION INSTRUCTIONS

KIT# 524431-4

ROADMASTER, Inc.

This bracket kit is one of our crossbar-style baseplates, which allows the visible front portion of the brackets to be easily removed (Fig.A and Fig.B). The kit consists of the main receiver brace, removable front braces and a hardware pack.

The main receiver brace mounts to the front frame on each side. The removable front braces insert into the receivers on each side.

Before starting the installation, lay out the kit components in order, as they will be used. This will give you a visual idea of how the components work, and will also confirm that everything is present and accounted for.



IMPORTANT: All baseplates **must** be assembled with all the bolts left loose for final adjustment and positioning (before tightening) unless otherwise instructed. All bolts **must** be torqued for proper strength. If more than one bolt is used per fastening point, the diagram may only show one.

- Use flat washers over all slotted holes
- Use lock washers on all fasteners

WARNING

Failure to follow these instructions can result in property damage, personal injury or even death.

- Installation of most baseplates requires moderate mechanical aptitude and skills. We strongly recommend professional installation by an experienced installer.
- The installer must read the instructions and use all bolts and parts supplied. Failure to do so could result in loss of the towed vehicle.
- Use Loctite® Red on all bolts used for mounting this bracket.
- Every 3,000 miles, the owner must inspect the fasteners for proper torque, according to the bolt torque requirements chart on the last page of these instructions. The owner must also inspect all mounting points for cracks or other signs of fatigue every 3,000 miles. Failure to do so could result in loss of the towed vehicle.
- The owner must check the vehicle manufacturer's instructions for the proper procedure(s) to prepare the vehicle for towing. Some vehicles must be equipped with a transmission lube pump, an axle disconnect, driveline disconnect or free-wheeling hubs before they can be towed. Failure to properly equip the vehicle will cause severe damage to the transmission.
- If running changes were made by the vehicle manufacturer after this kit was designed, some bolts or other fasteners in the hardware pack may no longer be the correct size. It is the installer's responsibility to verify that the baseplate is securely fastened to the vehicle and fitted with the correct hardware to account for these changes. Failure to securely fasten the baseplate could result in loss of the towed vehicle.
- If the towed vehicle has been in an accident, it must be properly repaired before attaching the baseplate. Do not install the baseplate if any structural frame damage is found. Failure to repair the damage could result in the loss of the towed vehicle.
- Roadmaster manufactures many styles of baseplates. If your baseplate has removable arms, they must be removed before driving the vehicle, unless the arms can be pinned or padlocked in place. If not secured, the arms could vibrate out, resulting in non-warranty damage or personal injury.
- Some motorhome chassis have such a tight turning radius that you can damage your motorhome, towed vehicle, tow bar or baseplate while turning sharply. Before getting on the road, test your turning radius in an empty parking lot. Turning too sharply could result in non-warranty damage to towing system, motorhome and/or towed vehicle.
- Do not back up with the towed vehicle attached or non-warranty damage will occur to your towing system, motorhome and/or towed vehicle.
- The safety cables must connect the towing vehicle to the towed vehicle frame to frame, with the cables crossed, with enough slack for sharp turns. Refer to the cable instructions for proper routing. Failure to leave enough slack in the safety cables, or failure to connect the safety cables frame to frame, will result in the loss of the towed vehicle.
- This kit is designed for use with ROADMASTER tow bars and ROADMASTER adaptors only. Using this kit with other brands, without an approved ROADMASTER adaptor, may result in non-warranty damage or injury.
- Do not use this document for custom fabrication, as it may not show all parts or structural components. Custom fabrication, or any attempt to copy this baseplate design, could result in loss of the towed vehicle.
- Upon final installation, the installer must inspect the baseplate to ensure adequate clearance, particularly around hoses, air conditioner lines, radiators, etc., or non-warranty damage to the towed vehicle will result.
- This baseplate is only warranted for the original installation. Installing a used baseplate on another vehicle is not recommended and will void the warranty.



BASEPLATE KIT INSTALLATION INSTRUCTIONS

KIT# 524431-4

ROADMASTER, Inc.



1. For all '10-'14 models (except Raptor): proceed to the supplement on page 10. For '10-'14 Raptor models: proceed to the supplement on page 12. For '15-'17 Raptor models: proceed to the supplement on page 14. For all other '15-'17 models without tow hooks: skip to step 4. For all other '15-'17 models with tow hooks: working on one side at a time, pull out and forward on the bottom rubber lip of the tow hook cover to release it from the fascia (Fig.C). Then, pull the rest of the tow hook cover all the way forward and then down to gain access to the tow hook bolts (Fig.D). For '18 and later models with tow hooks: proceed to the supplement on page 15.

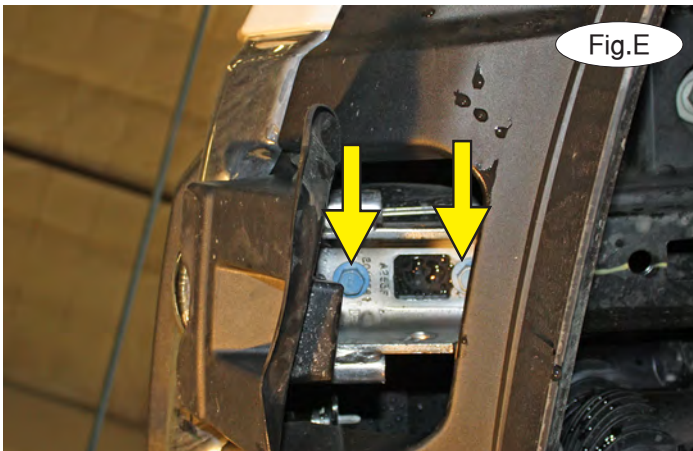

2. Remove the two 15mm (head) bolts attaching the tow hook to the frame rail (Fig.E). Then, use a screwdriver or other pointed object to slide the two-holed backing plate (inside the frame rail) forward enough to remove it from the tow hook opening. Figure F indicates the access points for removing the two-holed backing plate. The tow hook will not be replaced. *Note:* retain the tow hook and hardware for reinstallation in case the bracket is ever removed.

3. Repeat steps 1 and 2 for the opposite side of the vehicle.

For models with tow hooks, proceed to step 7.

4. Starting in the center and carefully working around all edges, pry the plastic fascia cover out of its mounting clips. *Note:* Figure G shows some of the clips on each side but not all.

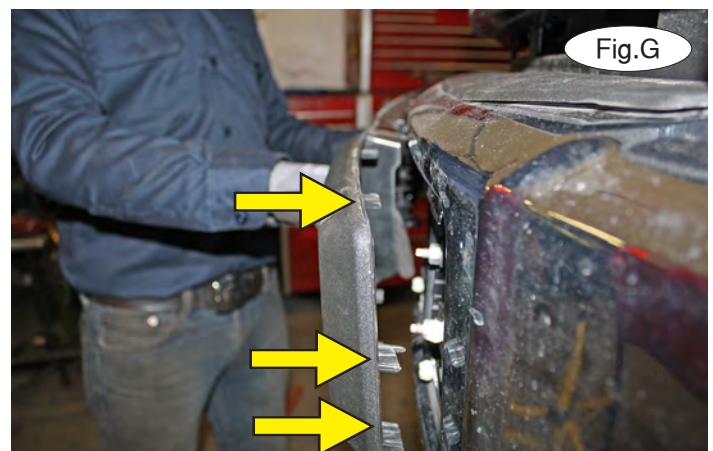



BASEPLATE KIT INSTALLATION INSTRUCTIONS

KIT# 524431-4

ROADMASTER, Inc.



5. On each side, remove two 5.5mm screws attaching the lower fascia to the bumper (Fig.H). *Note:* if the vehicle is equipped with an ACC unit, you can gain access to the bolts by using an extension with a universal joint (Fig.I). Once you have removed the bolts, use needlenose pliers to remove the 5.5mm screw slipnuts from behind the fascia. **Caution! Under no circumstances should you attempt to move, adjust or disconnect the ACC unit (indicated in red in Figure I).** Doing so may cause cruise control malfunction and/or computer error codes that may require the dealership to repair or reset.

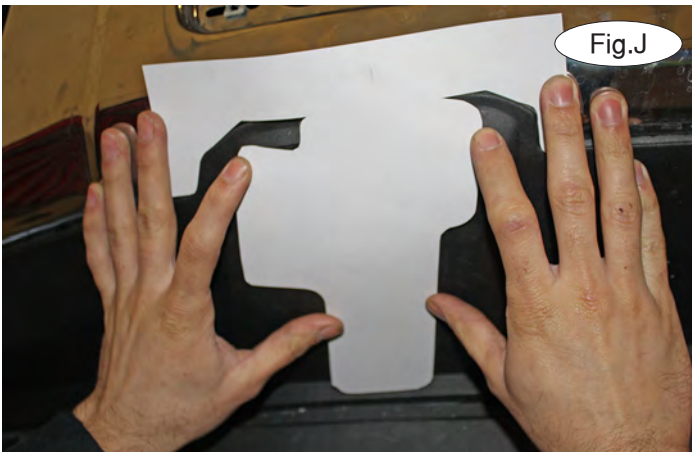

6. Locate the template at the end of these instructions. Cut out the template as shown and align it with the top profile of the lower fascia (Fig.J). Trace the template and then trim the fascia to allow clearance for the main receiver brace. *Note:* the top of the template should align as shown with the yellow lines in Figure K for best trimming results. You will also need to trim the upper edge of the lower fascia completely flat so only its mounting flange is left (Fig.L).





BASEPLATE KIT INSTALLATION INSTRUCTIONS

KIT# 524431-4

ROADMASTER, Inc.

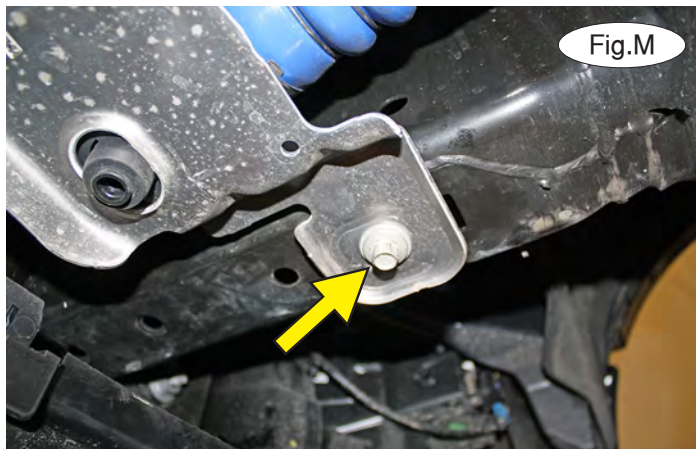

7. On each side, remove one 13mm (head) bolt attaching the intercooler support to the bottom of the frame (Fig.M). Carefully lower the intercooler and let it hang for now (Fig.N).

8. Working on one side at a time, access the forwardmost square hole exposed in the previous step and place one of the smaller weld nuts with rod over the existing holes. Repeat for the second hole. *Note:* a flashlight will be necessary to know when the threads are aligned over the tow hook mount holes (Fig.O). Then, bend the smaller weld nuts with rods as necessary so that they lay completely flat on the frame rail.

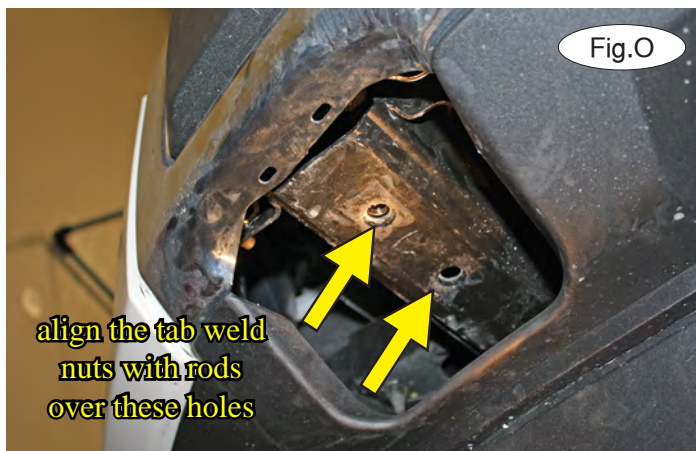

9. Lift the main receiver brace into place over the existing tow hook mounting holes in the frame rail, and using one of the supplied $\frac{1}{2}$ " x $3\frac{1}{2}$ " bolts and $\frac{1}{2}$ " lock washers, thread the bolt up through the forwardmost hole of the main receiver brace and finger tighten into the smaller weld nut with rod (Fig.P). Now, using one of the supplied $\frac{1}{2}$ " x $1\frac{1}{2}$ " bolts and $\frac{1}{2}$ " lock washers, thread the rear bolt up through the main receiver brace and into the smaller weld nut with rod (Fig.Q). *Note: ensure proper alignment, as the bolts will receive Loctite® Red and will be torqued at the end of these instructions.*





BASEPLATE KIT INSTALLATION INSTRUCTIONS

KIT# 524431-4

ROADMASTER, Inc.



10. Using the rear hole of the main receiver brace as a template for drilling, drill a $\frac{1}{2}$ " hole through the outside layer of the frame rail (Fig.R). *Note:* use a shorter drill bit due to the lack of clearance for drilling.

11. Insert a $\frac{3}{16}$ " x 2" O.D. spacer between the frame and the bracket and then loosely bolt through the main receiver brace, spacer and into the frame rail using the supplied $\frac{1}{2}$ " x $1\frac{1}{2}$ " bolt and $\frac{1}{2}$ " lock washer (Fig.S). Then, locate the end of the bolt you just installed (Fig.T) and insert one of the larger threaded backing plates with rod into the access hole and over the bolt. Thread the bolt into the backing plate.

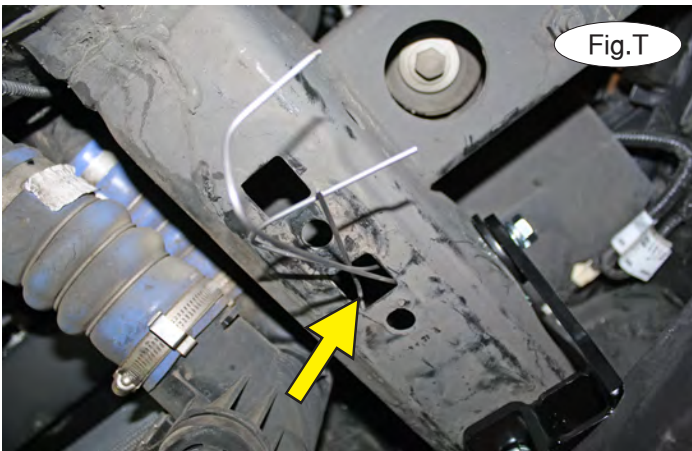

12. Repeat steps 8 through 11 for the other side of the vehicle.

13. Bend all the rods back against the frame and then reinstall the intercooler and its support by reversing step 7, trapping the rods from the weld nuts against the frame (Fig.U). Trim off the excess rods.

14. Tighten all bolts to the bolt torque requirements found at the end of these instructions. *Note: use Loctite® Red on all nuts and bolts.*



BASEPLATE KIT INSTALLATION INSTRUCTIONS

KIT# 524431-4

ROADMASTER, Inc.



15. **For models with tow hooks:** proceed to the next step. **For models without tow hooks:** reinstall the plastic fascia cover, reversing step 4. *Note:* use a flathead screwdriver to bend the teeth of the slipnuts back to ease reinstallation (Fig.V).

16. If you are using the included wiring plug mount, hold it inside the upper edge of the grille opening, far enough forward to be able to screw into the steel of the bumper to hold it in place securely. Mark the holes for drilling (Fig.W).



17. Unclip the license plate holder and remove it for now (Fig.X).

18. Use a $\frac{1}{4}$ " drill bit to drill out the holes you marked in step 17. Install the wiring plug mount using the two included 6mm x 1.0 x 20mm bolts, 6mm flat washers and 6mm Nylock nuts.

19. If you are installing a breakaway unit, use the included bracket (Fig.Y). Use the two supplied self-tapping screws to install it to the corner of the grille opening (Fig.Z). Ensure that you mount it far enough forward to screw into the steel of the bumper to hold it in place securely.

Reinstall the license plate holder.





BASEPLATE KIT INSTALLATION INSTRUCTIONS

KIT# 524431-4

ROADMASTER, Inc.



20. Tighten all bolts to the bolt torque requirements found at the end of these instructions. *Note:* use Loctite® Red on all nuts and bolts.

21. Reinstall the fascia, reversing steps 1 through 6.

22. ***Note: the following four images are for illustration purposes only, as your specific application may be slightly different.***

The spring-loaded pin on the removable arm snaps into a notch on the receiver, locking the removable arm into its final towing position. Before inserting each arm into the receiver, verify that the spring is working by ensuring that the spring-loaded pin moves easily back and forth within the barrel when pulled and that it can be pulled flush with the face of the barrel (Fig.AA and Fig.BB).

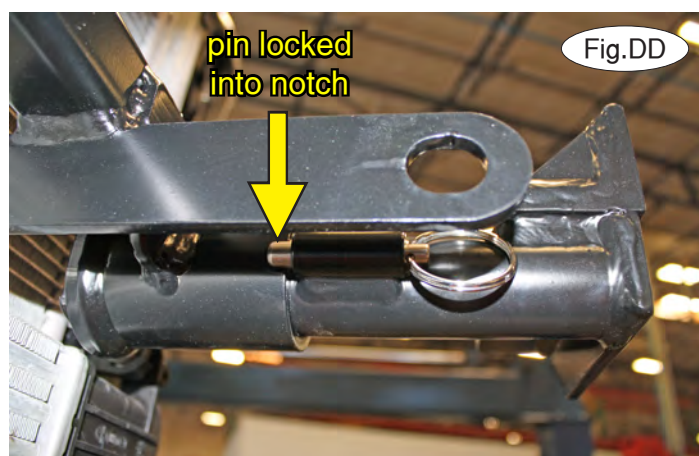
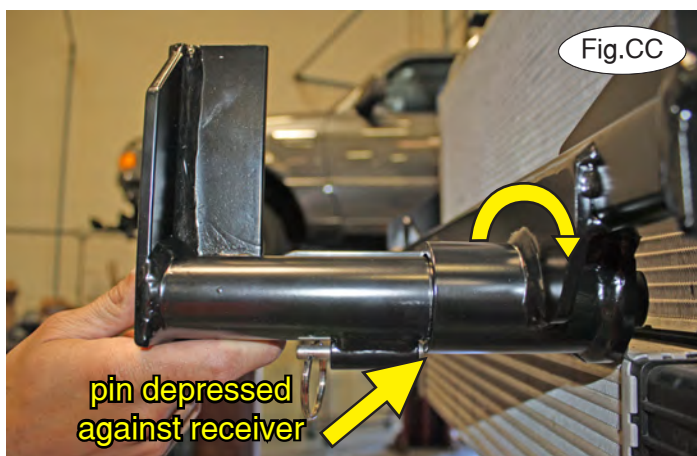

23. On each side, insert the removable front bracket arm into the front receiver 90 degrees from its final towing position, depressing the spring-loaded pin against the receiver (Fig.CC). Now, twist back 90 degrees until the spring-loaded pin snaps into place in the notch on the receiver, locking the arm into place in its final towing position (Fig.DD).

Please note: it is the owner's responsibility to ensure the locking of the pins before towing. Otherwise, failure of the towing system will result.

24. Install the tow bar to the mounting bracket according to the manufacturer's instructions.



BASEPLATE KIT INSTALLATION INSTRUCTIONS

KIT# 524431-4

ROADMASTER, Inc.

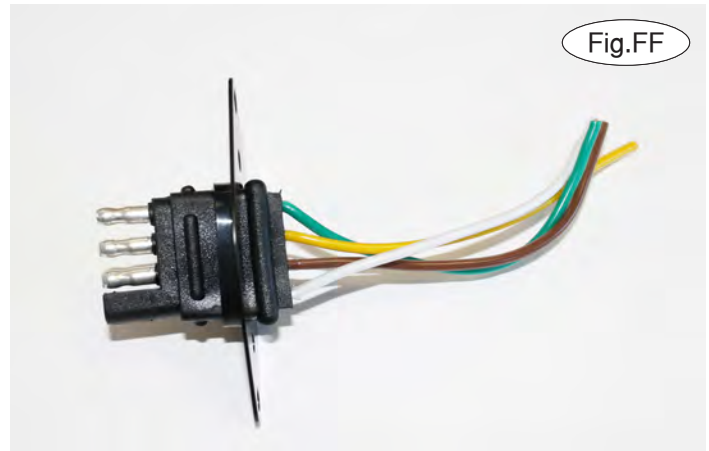
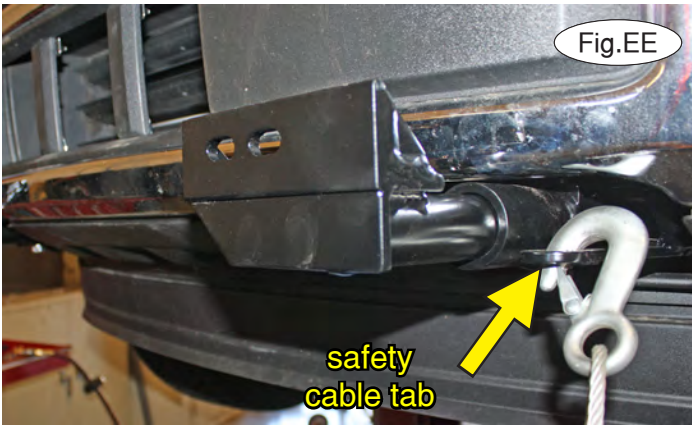

IMPORTANT!

Safety cables are required by law. When towing, connect safety cables to the safety cable tabs illustrated on the first page and in Figure EE. Make certain there is adequate slack in the cables to allow a full turning radius; otherwise, damage will result. If necessary, longer cables or cable extensions are available.

Three options for attaching the wiring plug to the main receiver brace

For six-wire plugs: use the two supplied 3/4" self-tapping screws to attach the electrical plug directly to the rods on the front of the main receiver brace.

For four-wire round plugs: attach to the plug mounting plate and then use the two supplied 3/4" self-tapping screws to attach the mounting plate to the rods on the front of the main receiver brace.

For four-wire flat plugs: place the plug through the mounting plug plate, and then secure it using the supplied zip tie on the front of the plug (Fig.FF). Use the two supplied 3/4" self-tapping screws to attach the mounting plate to the rods on the front of the main receiver brace.

BOLT TORQUE REQUIREMENTS

Note: The torque values represented below are intended as general guidelines. Torque requirements for specific applications may vary. Roadmaster does not warrant this information to be accurate for all applications and disclaims all liability for any claims or damages which may result from its use.

STANDARD BOLTS

Thread Size	Grade	Torque
5/16.....	5.....	13 ft./lb.
3/8.....	5.....	23 ft./lb.
7/16.....	5.....	37 ft./lb.
1/2.....	5.....	56 ft./lb.
5/8.....	5.....	150 ft./lb.

METRIC BOLTS

Thread Size	Grade	Plated / Unplated
8mm-1.0.....	8.8.....	20 ft./lb. 18 ft./lb.
8mm-1.25.....	8.8.....	19 ft./lb. 18 ft./lb.
10mm-1.25.....	8.8.....	38 ft./lb. 36 ft./lb.
10mm-1.5.....	8.8.....	37 ft./lb. 35 ft./lb.

METRIC BOLTS

Thread Size	Grade	Plated / Unplated
12mm-1.25.....	8.8.....	70 ft./lb. 65 ft./lb.
12mm-1.5.....	8.8.....	66 ft./lb. 61 ft./lb.
12mm-1.75.....	8.8.....	65 ft./lb. 60 ft./lb.
14mm-2.0.....	8.8.....	104 ft./lb. 97 ft./lb.

All illustrations and specifications contained herein are based on the latest information available at the time of publication approval. ROADMASTER, INC. reserves the right to make changes at any time without notice in material, specification and models or to discontinue models.



BASEPLATE KIT INSTALLATION INSTRUCTIONS

KIT# 524431-4

ROADMASTER, Inc.

**For '10-'14 models (except Raptor):
follow the instructions below to install the bracket.**



1. **Important:** please use all supplied bolts and parts and read all instructions carefully before beginning this installation. The majority of questions you may have can be answered within the text, and proper installation will ensure safe and secure travel. Now, begin the installation. **For '10-'14 models without tow hooks:** trim the bumper on each side as shown to allow clearance for the main receiver braces, following the indents in the splash shield to aid in the trimming (Fig.C). Figure D shows the completed trimming. Now, skip to step 3. **For all other models:** proceed to step 2.



2. Working on the driver's side only, remove two 15mm (head) bolts and the two-holed backing plate attaching the tow hook to the bottom of the frame rail (Fig.E). The tow hook will not be replaced. *Note:* retain the tow hook and hardware for reinstallation in case the bracket is ever removed.

3. Place one of the supplied 1/2" lock washers over one of the 1/2" x 1 1/2" bolts, and bolt up through the rear hole of the main receiver brace (Fig.F). Place the main receiver brace behind the forward splash shield, aligning the holes with the existing holes in the frame rail (Fig.G). Bolt up through the main receiver brace, tow hook mount and into the frame rail using the 1/2" x 1 1/2" bolt (Fig.H).





BASEPLATE KIT INSTALLATION INSTRUCTIONS

KIT# 524431-4

ROADMASTER, Inc.



4. Place one of the supplied smaller weld nuts with rod over the bolt you just installed in the previous step (Fig.I). *Note:* use Loctite® Red on all bolts used for mounting this bracket.

5. Place one of the larger threaded backing plates with rod inside the frame rail and over the inside upper mounting point of the main receiver brace. Place a ½" lock washer over one of the supplied ½" x 1½" bolts, and bolt through the outside of the frame rail and into the backing plate (Fig.J).



6. Place one of the supplied ½" lock washers over one of the ½" x 3½" bolts and bolt up through the front hole in the main receiver brace, tow hook mounting hole, the frame rail and into one of the smaller weld nuts with rod.

7. Torque the two bolts in the bottom of the frame rail and then the top nuts using the bolt torque requirements found at the end of these instructions.

8. Repeat steps 2 through 7 for the passenger side of the vehicle.

9. Using a pair of pliers, break the wires off all the backing plates (Fig.K).

10. Insert the removable front bracket arms into the front receiver braces. Attach the 8" safety cables with the cable connectors (Q-Links) to the front of the receiver braces.



BASEPLATE KIT INSTALLATION INSTRUCTIONS

KIT# 524431-4

ROADMASTER, Inc.

For '10-'14 Raptor models only: follow the instructions below to remove the bumper and skidplate.

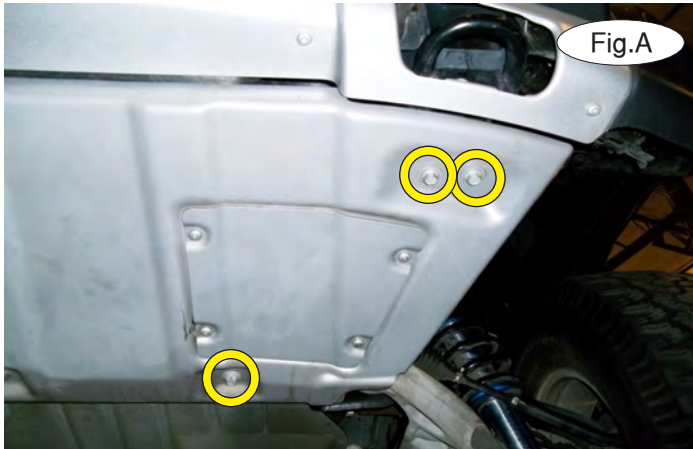

1. On each side, remove three 15mm (head) bolts attaching the skid plate to the frame (Fig.A – driver's side).
2. On each side, remove one 15mm (head) bolt attaching the skid plate mounting bracket to the frame rail (Fig.B).

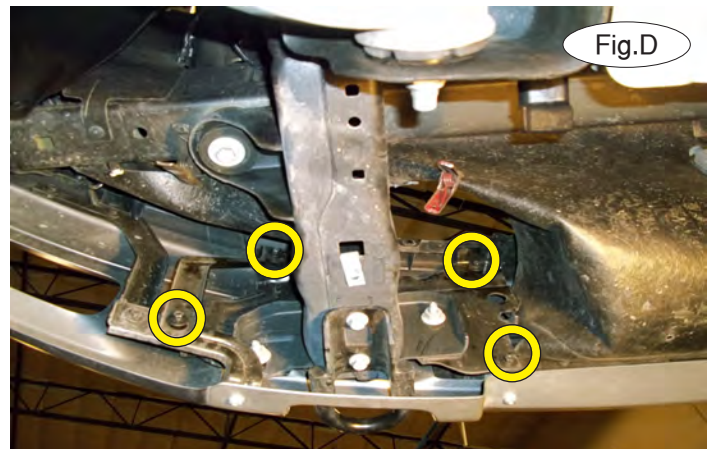

3. Remove three plastic fasteners attaching the splash shield to the bumper (Fig.C).
4. On each side, remove four 10mm (head) bolts attaching the bumper and support bracket to the frame rail (Fig.D).
5. Pull down and forward to release the bumper (Fig.E).

Now, proceed to step 2 on page 10 to install the bracket.





BASEPLATE KIT INSTALLATION INSTRUCTIONS

KIT# 524431-4

ROADMASTER, Inc.



6. Reinstall the bumper by reversing steps 3 through 5 in this supplement.
7. Working on one side at a time, place one of the supplied 5/8" x 1" x .188 wall pipe spacers between the frame and the skid plate mounting bracket you removed in step 2 of this supplement. Now, using the supplied 10mm x 1.5 x 55mm bolt, 10mm lock washer and 3/8" washer, bolt up through the bracket, through the spacer and into the bracket mount. The yellow arrow in Figure F indicates the location of the spacer.
8. Finish reinstalling the skid plate by reversing step 1 in this supplement.
9. Due to manufacturing variances, it may be necessary to trim a small amount on the fascia to allow clearance for the main receiver brace. If this is the case, use the yellow line in Figure G as a guide for trimming the tab in the grille opening.



BASEPLATE KIT INSTALLATION INSTRUCTIONS

KIT# 524431-4

ROADMASTER, Inc.

For '15 and later Raptor models only: follow the instructions below to remove the bumper and skidplate.

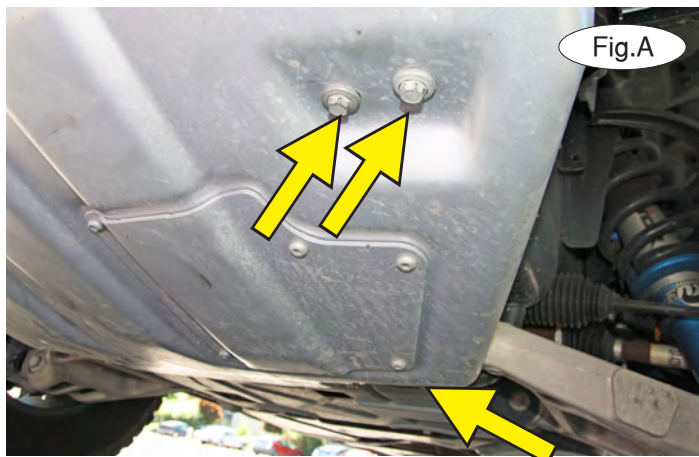

1. On each side, remove two 13mm and one 15mm (head) bolts attaching the skid plate to the frame (Fig.A).
2. On each side, remove one 15mm (head) bolt attaching the S bracket shown in Figure B.



3. On each side, remove two 15mm (head) bolts attaching the tow hook to the frame and pull off the cover (Fig.C).

Now, proceed to page 5, and complete steps 8 through 14. Then, return to this supplement to finish the installation.

4. Working on one side at a time, place one of the supplied 5/8" x 1" x .188 wall pipe spacers between the frame and the skid plate mounting bracket you removed in step 2 of this supplement. Now, using the supplied 10mm x 1.5 x 55mm bolt, 10mm lock washer and 3/8" washer, bolt up through the bracket, through the spacer and into the bracket mount. The yellow arrow in Figure D indicates the location of the spacer.

5. Finish reinstalling the skid plate by reversing step 1 in this supplement. Figure E shows the final installation.





BASEPLATE KIT INSTALLATION INSTRUCTIONS

KIT# 524431-4

ROADMASTER, Inc.

For '18 and later models with tow hooks



1. On each side, pry out on the plastic fascia cover to remove it (Fig.A – driver's side). **For models without ACC:** skip to 3. **For models with ACC:** please read the note below before proceeding to step 2.

IMPORTANT!

The following step requires the disconnection of the ACC unit and its removal from the bumper.

Before proceeding, ensure that the key is in the 'off' position, and then disconnect the negative battery terminal.

It is imperative that when loosening the top nut, as the next step directs you to do, that you do not allow the adjustment bolt to turn.

If the adjustment bolt turns, it is possible that the ACC unit will need to be recalibrated by the Ford dealership to ensure proper function.



2. On the driver's side, there are three 11mm (head) nuts attaching the ACC unit to the bumper. Remove the two bottom nuts. Then, use a wrench and needle-nose pliers – along with extreme care – to remove the top nut, which is on the adjusting bolt (Fig.B). Gently pry the ACC off its ball mounts (Fig.C) and let it hang down for now.

3. On each side, remove three 13/16" nuts attaching the bumper to the frame (Fig.D). *Note:* the third 13/16" nut is on the back side of the bumper, near the frame rail. Its approximate location is noted by the arrow in Figure D.



BASEPLATE KIT INSTALLATION INSTRUCTIONS

KIT# 524431-4

ROADMASTER, Inc.



Fig.E



Fig.F

4. Remove the bumper (Fig.E). *Note:* it may be easier for the removal if a second person assists with this step. Disconnect the wiring connectors, and the fog lights, if the vehicle is so equipped.

5. On each side, remove the tow hook cover and remove the two exposed 15mm (head) bolts attaching the tow hook to the frame (Fig.F). *Note:* the tow hook cover will not be replaced. Retain it for replacement in case the bracket is ever removed.



Fig.G



Fig.H

6. Working on one side at a time, position the main receiver brace below the frame rail, aligning it with the existing tow hook mount holes in the frame rail. Then, using one of the supplied $\frac{1}{2}$ " x $3\frac{1}{2}$ " bolts and $\frac{1}{2}$ " lock washers, thread the bolt up through the forwardmost hole of the main receiver brace and finger tighten into the smaller weld nut with rod.

Now, using one of the supplied $\frac{1}{2}$ " x $1\frac{1}{2}$ " bolts and $\frac{1}{2}$ " lock washers, thread the rear bolt up through the main receiver brace and into the smaller weld nut with rod (Fig.G). ***Note: ensure proper alignment, as the bolts will receive Loctite® Red and will be torqued at the end of these instructions.***

7. Using the rear hole of the main receiver brace as a template for drilling, drill a $\frac{1}{2}$ " hole through the outside layer of the frame rail (Fig.H). *Note:* use a shorter drill bit due to the lack of clearance for drilling.



BASEPLATE KIT INSTALLATION INSTRUCTIONS

KIT# 524431-4

ROADMASTER, Inc.

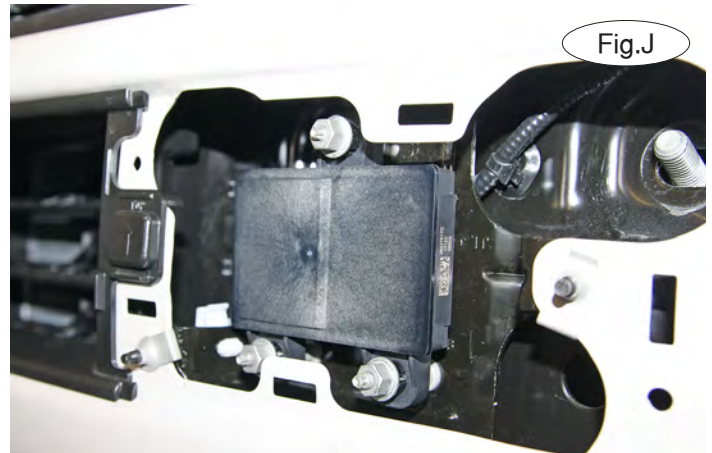

8. Insert a 3/16" x 2" O.D. spacer between the frame and the bracket and then loosely bolt through the main receiver brace, spacer and into the frame rail using the supplied 1/2" x 1 1/2" bolt and 1/2" lock washer (Fig.I). Then, locate the end of the bolt you just installed and insert one of the larger threaded backing plates with rod into the frame rail and over the bolt. Thread the bolt into the backing plate.
9. Torque the bolts to the bolt torque requirements found at the end of these instructions.
10. Repeat steps 6 through 9 for the passenger side of the vehicle.
11. Reinstall the bumper and the ACC unit (Fig.J), if the vehicle is so equipped, by reversing steps 1 through 4. As with the removal of the ACC unit, use extreme caution when reinstalling it. *Note:* when reinstalling the bumper, use the rubber covering on the top to align it appropriately with the body of the vehicle
12. Re-attach the negative battery terminal.

KIT# 524431-4

***2015 and later models trim template
for vehicles without tow hooks***

