

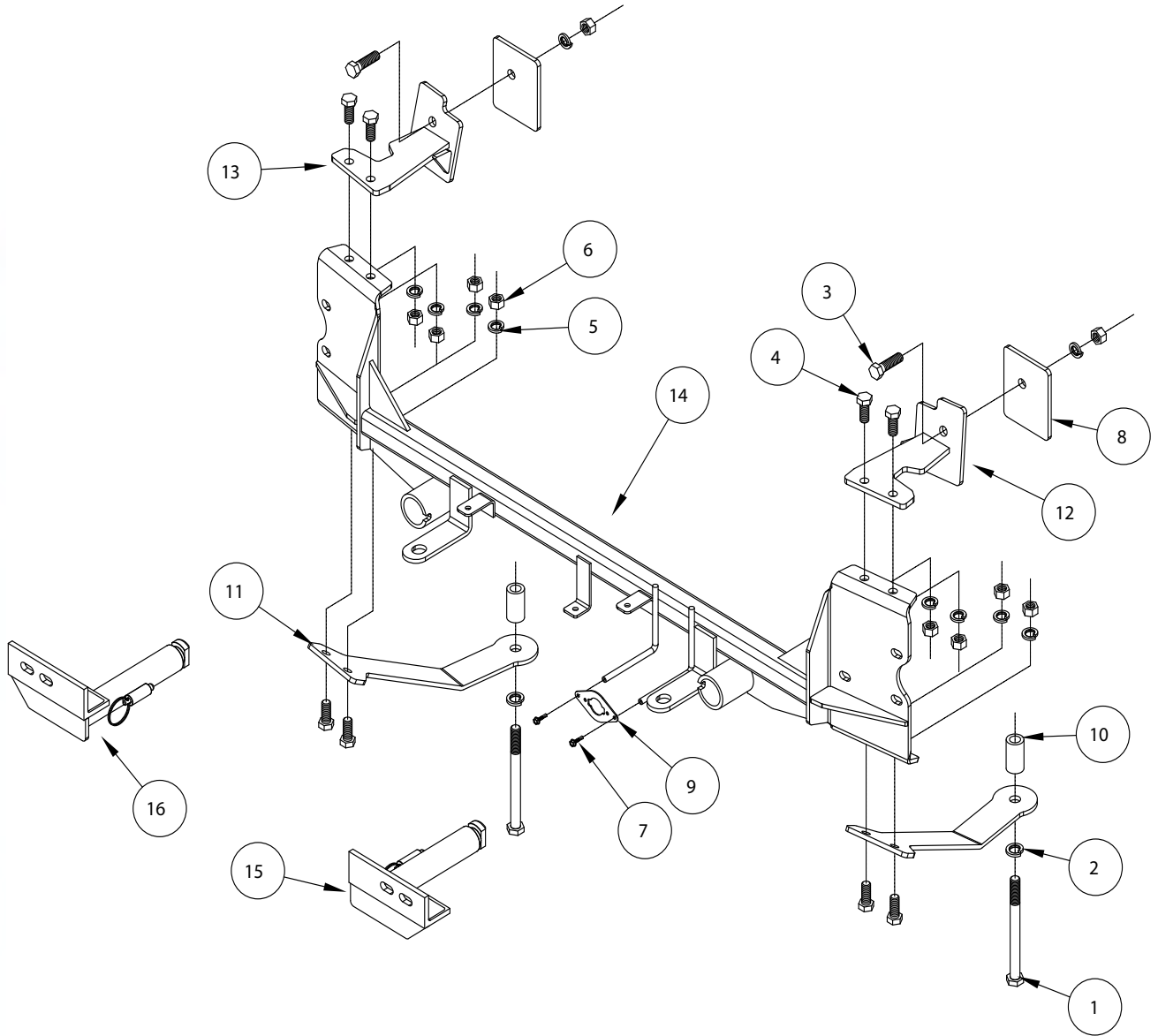

BASEPLATE KIT INSTALLATION INSTRUCTIONS

KIT #523160-4

ROADMASTER, Inc.



ITEM	QTY	NAME	PART #
1.....2.....	2.....	14mm x 2.00 x 160mm BOLT	355910-16
2.....2.....	2.....	14mm LOCK WASHER.....	355740-00
3.....2.....	2.....	1/2" x 1 3/4" BOLT	350096-00
4.....8.....	8.....	1/2" x 1 1/4" BOLT	350094-00
5.....10.....	10.....	1/2" LOCK WASHER.....	350309-00
6.....10.....	10.....	1/2" NUT.....	350258-00
7.....2.....	2.....	#10 x 3/4" SELF DRILLING SCREW	350247-35
8.....2.....	2.....	3 1/2" x 4 1/2" BACKING PLATE.....	A-002964
9.....1.....	1.....	WIRE PLUG PLATE	A-003801
10.....2.....	2.....	1" O.D. x 1 7/8" TUBE SPACER	A-004511
11.....2.....	2.....	LOWER MOUNTING PLATE	B-002454
12.....1.....	1.....	DRIVER SIDE UPPER BRACE	C-001879
13.....1.....	1.....	PASSENGER SIDE UPPER BRACE.....	C-001880
14.....1.....	1.....	MAIN RECEIVER BRACE	C-003045
15.....1.....	1.....	DRIVER SIDE ARM	C-003046
16.....1.....	1.....	PASSENGER SIDE ARM.....	C-003047
17.....4.....	4.....	ZIP TIE	300140-10



BASEPLATE KIT INSTALLATION INSTRUCTIONS

KIT #523160-4

ROADMASTER, Inc.

This bracket kit is one of our EZ4 series, which allows the visible front portion of the brackets to be easily removed (Fig.A and Fig.B). The kit consists of the main receiver brace, removable front braces and a hardware pack.

The main receiver brace mounts to the frame. The removable front braces insert into the receivers on each side and are secured with draw pins.

Before starting the installation, lay out the kit components in order, as they will be used. This will give you a visual idea of how the components work, and will also confirm that everything is present and accounted for.



IMPORTANT: All brackets **must** be assembled with all the bolts left loose for final adjustment and positioning (before tightening) unless otherwise instructed. All bolts **must** be torqued for proper strength. If more than one bolt is used per fastening point, the diagram may only show one.

- Use flat washers over all slotted holes
- Use lock washers on all fasteners

WARNING

Failure to follow these instructions can result in property damage, personal injury or even death.

- **Installation of most mounting brackets requires moderate mechanical aptitude and skills.** We strongly recommend professional installation by an experienced installer.
- **The installer must read the instructions and use all bolts and parts supplied.** Failure to do so could result in loss of the towed vehicle.
- **Use Loctite® Red** on all bolts used for mounting this bracket.
- **Every 3,000 miles, the owner must inspect the fasteners** for proper torque, according to the bolt torque requirements chart on the last page of these instructions. **The owner must also inspect all mounts and brackets for cracks or other signs of fatigue every 3,000 miles.** Failure to do so could result in loss of the towed vehicle.
- **The owner must check the vehicle manufacturer's instructions for the proper procedure(s) to prepare the vehicle for towing.** Some vehicles must be equipped with a transmission lube pump, an axle disconnect, driveline disconnect or free-wheeling hubs before they can be towed. Failure to properly equip the vehicle will cause severe damage to the transmission.
- **If running changes were made** by the vehicle manufacturer after this bracket was designed, some bolts or other fasteners in the hardware pack may no longer be the correct size. **It is the installer's responsibility** to verify that the bracket is securely fastened to the vehicle and fitted with the correct hardware to account for these changes. Failure to securely fasten the bracket could result in loss of the towed vehicle.
- If the towed vehicle has been in an accident, it must be properly repaired before attaching the bracket. **Do not install the bracket if any structural frame damage is found.** Failure to repair the damage could result in the loss of the towed vehicle.
- Roadmaster manufactures many styles of brackets. **If your bracket has removable arms, they must be removed before driving the vehicle, unless the arms can be pinned or padlocked in place.** If not secured, the arms could vibrate out, resulting in non-warranty damage or personal injury.
- Some motorhome chassis have such a tight turning radius that you can damage your motorhome, towed vehicle, tow bar or bracket while turning sharply. **Before getting on the road, test your turning radius in an empty parking lot.** Turning too sharply could result in non-warranty damage to towing system, motorhome and/or towed vehicle.
- **Do not back up with the towed vehicle attached** or non-warranty damage will occur to your towing system, motorhome and/or towed vehicle.
- **The safety cables must connect the towing vehicle to the towed vehicle frame to frame, with the cables crossed, with enough slack for sharp turns.** Refer to the cable instructions for proper routing. Failure to leave enough slack in the safety cables, or failure to connect the safety cables frame to frame, will result in the loss of the towed vehicle.
- This bracket is designed for use with ROADMASTER tow bars and ROADMASTER adaptors only. **Using this bracket with other brands, without an approved ROADMASTER adaptor, may result in non-warranty damage or injury.**
- **Do not use this document for custom fabrication,** as it may not show all parts or structural components. Custom fabrication or an attempt to copy this bracket design could result in loss of the towed vehicle.
- Upon final installation, **the installer must inspect the bracket to ensure adequate clearance, particularly around hoses, air conditioner lines, radiators, etc.,** or non-warranty damage to the towed vehicle will result.
- **This bracket is only warranted for the original installation.** Installing a used bracket on another vehicle is not recommended and will void the warranty.



BASEPLATE KIT INSTALLATION INSTRUCTIONS

KIT #523160-4

ROADMASTER, Inc.



1. **Important:** please use all supplied bolts and parts and read all instructions carefully before beginning this installation. The majority of questions you may have can be answered within the text, and proper installation will ensure safe and secure travel. Now, begin the installation. Remove four plastic fasteners and either four 7mm (head) screws or four T20 torx bolts attaching the top of the fascia to the core support (Fig.C).



2. On each side, remove one 7mm (head) screw attaching the corner of the fascia to the fender (Fig.D).
3. On each side, remove one T20 Torx screw and three plastic fasteners attaching the fender liner to the fascia (Fig.E).

Note: due to manufacturing variances, there may be two screws and two plastic fasteners.

4. On each side, remove two T20 Torx screws attaching the bottom of the fender liners to the fascia (Fig. F – driver's side). *Note:* due to manufacturing variances, there may be two 7mm screws instead.

5. Disconnect the fog lights, if the vehicle is so equipped. Pull forward on the corners of the fascia to remove the locking strip (Fig.G).

Now, go to the supplemental instructions at this time if the vehicle is equipped with a power steering cooler. If not, continue with step 6.

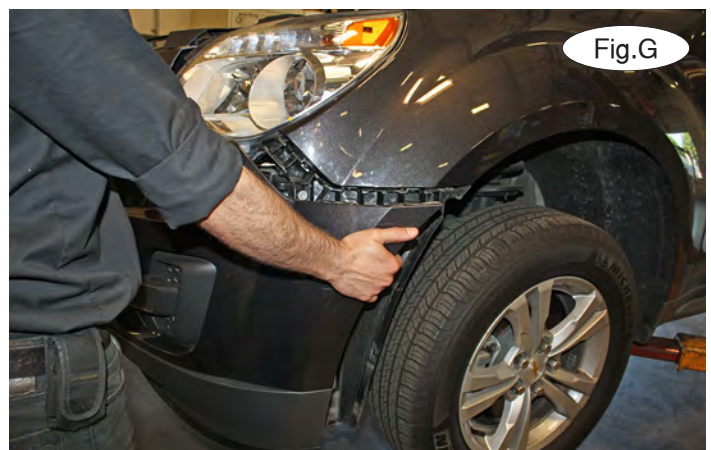



BASEPLATE KIT INSTALLATION INSTRUCTIONS

KIT #523160-4

ROADMASTER, Inc.

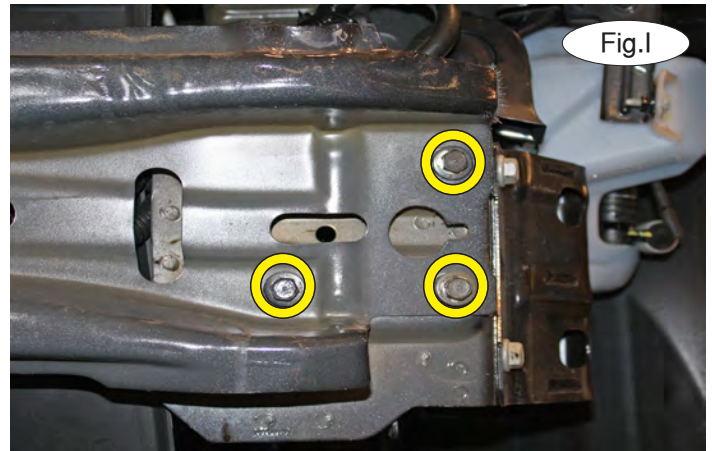

6. Unsnap five plastic clips to remove the wiring harness from the back of the bumper core (Fig.H).

7. On each side, remove three 13mm (head) bolts attaching the bumper core to the frame rails (Fig.I). The bumper core will not be replaced. Retain the bumper core in case the bracket is ever removed. *Note:* due to manufacturing variances, there may be four 13mm (head) bolts instead.

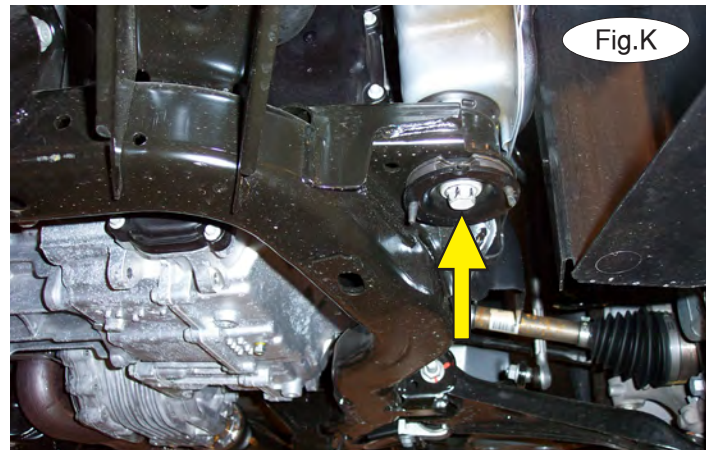
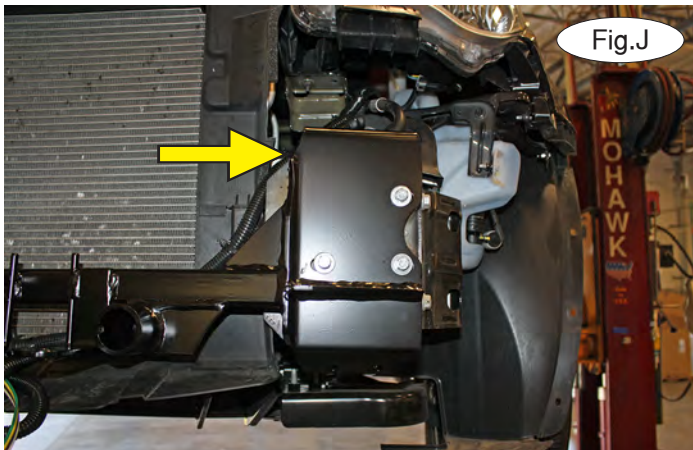

8. Before you install the main receiver brace, unsnap the fastener securing the loom to the frame on each side (Fig.J – yellow arrow).

Now, place thread lock on the bolts you removed in the previous step and use them to attach the main receiver brace to the ends of the frame rails (Fig.J).

Tighten the bolts to the bolt torque requirements found at the end of these instructions.

9. Working on the driver's side, remove the 18mm subframe bolt (Fig.K). ***Note: do not remove both subframe bolts without supporting the frame.*** *Note:* due to manufacturing variances, you may notice some additional framing on your vehicle.

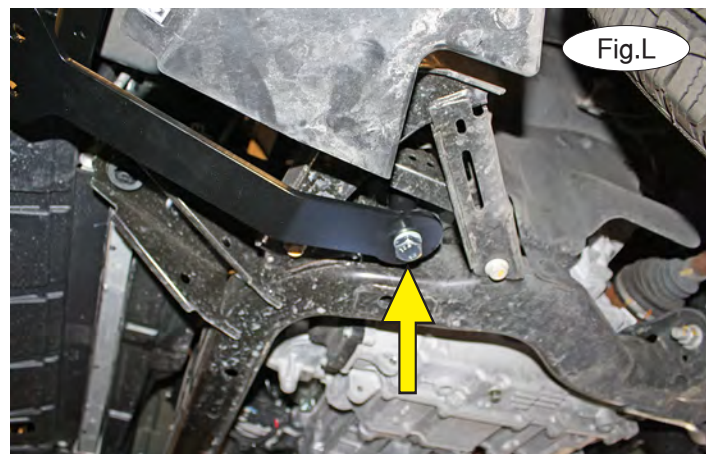

10. Place thread lock on one of the supplied 14mm x 2.0 x 160mm bolts, and bolt through the lower rear brace and a 1" x 1 7/8" pipe spacer and into the subframe (Fig.L).



BASEPLATE KIT INSTALLATION INSTRUCTIONS

KIT #523160-4

ROADMASTER, Inc.

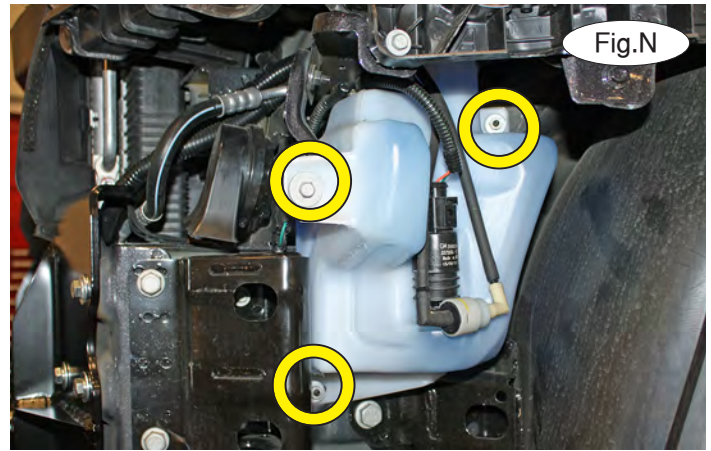

11. Using two of the supplied $\frac{1}{2}$ " x $1\frac{1}{4}$ " bolts, lock washers and nuts, bolt the lower rear brace to the main receiver brace (Fig.M). Tighten the bolts to the bolt torque requirements found at the end of this document.
12. Repeat steps 9 through 11 for the passenger side of the vehicle.
13. Working on the driver's side, remove the 10mm bolt and two 10mm nuts attaching the washer bottle to the frame rail (Fig.N). Unmount the washer bottle and let it hang down for now.

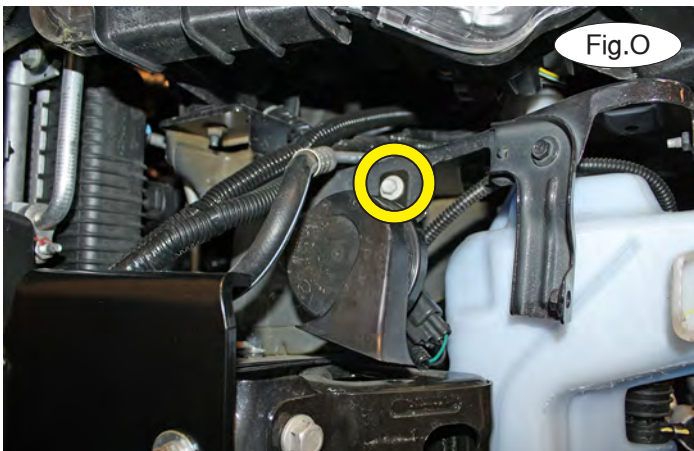

14. Remove one 10mm (head) bolt attaching the horn to the framing on the driver's side (Fig.O).
15. Position the driver's side upper rear brace over the top of the main receiver brace, aligning the holes. Then, using two of the supplied $\frac{1}{2}$ " x $1\frac{1}{4}$ " bolts, lock washers and nuts, bolt the upper rear brace to the main receiver brace (Fig.P).
16. Place one of the $3\frac{1}{2}$ " x $4\frac{1}{2}$ " backing plates through the opening in the side of the frame behind the upper rear brace, aligning its hole with the hole in the upper rear brace (Fig.Q).





BASEPLATE KIT INSTALLATION INSTRUCTIONS

KIT #523160-4

ROADMASTER, Inc.

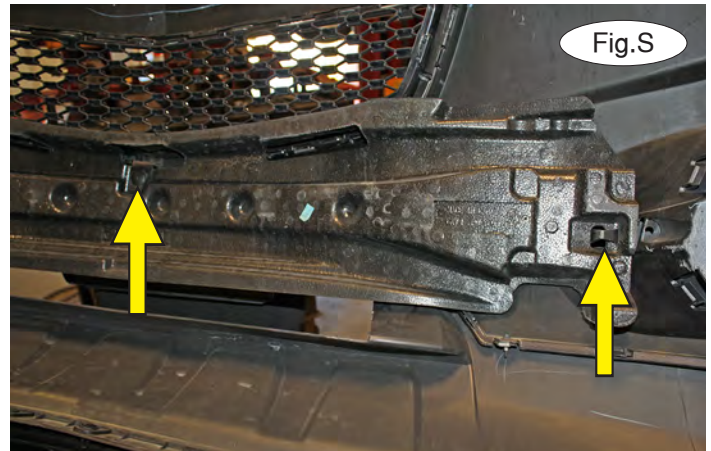

17. Bolt the backing plate to the upper rear brace using one of the supplied $\frac{1}{2}$ " x $1\frac{1}{2}$ " bolts, lock washers and nuts (Fig.R).

18. Torque the bolts to the bolt torque requirements found at the end of this document.

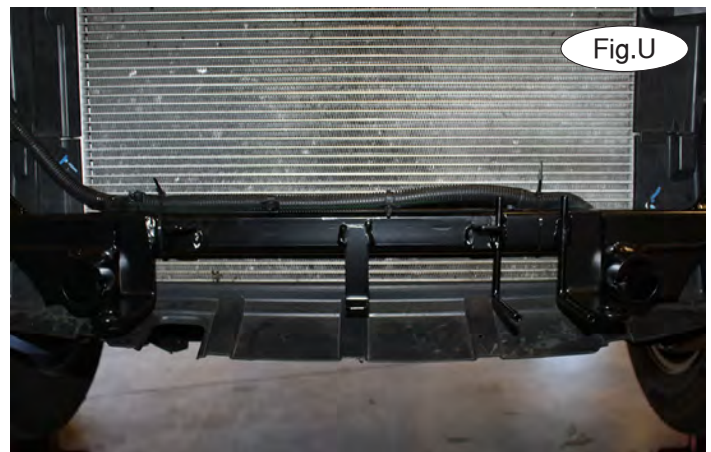

19. **Reverse** steps 13 and 14, and then **repeat** 15 through 18 for the passenger side of the vehicle. Now, return to step 3 in the supplemental instructions at this time, if the vehicle is equipped with a power steering cooler. If not, continue with step 20.

20. Remove the foam shock absorption pad from the back of the fascia by removing two plastic clips and one fastener. It will not be replaced. Retain the foam shock absorption pad and its attachment hardware for replacement in case the bracket is ever removed. *Note:* Figure S only shows one clip and the fastener.

21. Trim the fascia using Figure T as a reference.

22. Using two of the supplied zip ties, attach the wiring harness to the main receiver brace (Fig.U).

23. Reassemble the fascia by reversing steps 1 through 5. Now, return to step 7 in the supplement if your vehicle is equipped with a power steering cooler. If not, continue with step 24.



BASEPLATE KIT INSTALLATION INSTRUCTIONS

KIT #523160-4

ROADMASTER, Inc.



24. **Note: the following four images are for illustration purposes only, as your specific application may be slightly different.**

The spring-loaded pin on the removable arm snaps into a notch on the receiver, locking the removable arm into its final towing position. Before inserting each arm into the receiver, verify that the spring is working by ensuring that the spring-loaded pin moves easily back and forth within the barrel when pulled and that it can be pulled flush with the face of the barrel (Fig.V and Fig.W).

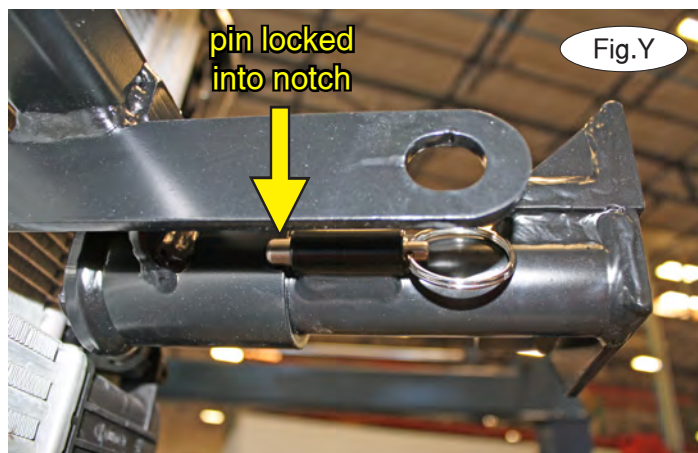

25. On each side, insert the removable front bracket arm into the front receiver 90 degrees from its final towing position, depressing the spring-loaded pin against the receiver (Fig.X). Now, twist back 90 degrees until the spring-loaded pin snaps into place in the notch on the receiver, locking the arm into place in its final towing position (Fig.Y).

Please note: it is the owner's responsibility to ensure the locking of the pins before towing. Otherwise, failure of the towing system will result.

26. Install the tow bar to the mounting bracket according to the manufacturer's instructions.



BASEPLATE KIT INSTALLATION INSTRUCTIONS

KIT #523160-4

ROADMASTER, Inc.

IMPORTANT!

Safety cables are required by law. When towing, connect safety cables to the safety cable tabs illustrated in Figure Z. Make certain there is adequate slack in the cables to allow a full turning radius; otherwise, damage will result. If necessary, longer cables or cable extensions are available.



Fig.Z

Three options for attaching the wiring plug to the main receiver brace

For six-wire plugs: use the two supplied 3/4" self-tapping screws to attach the electrical plug directly to the rods on the front of the main receiver brace.

For four-wire round plugs: attach to the plug mounting plate and then use the two supplied 3/4" self-tapping screws to attach the mounting plate to the rods on the front of the main receiver brace.

For four-wire flat plugs: place the plug through the mounting plug plate, and then secure it using the supplied zip tie on the front of the plug (Fig.AA). Use the two supplied 3/4" self-tapping screws to attach the mounting plate to the rods on the front of the main receiver brace.

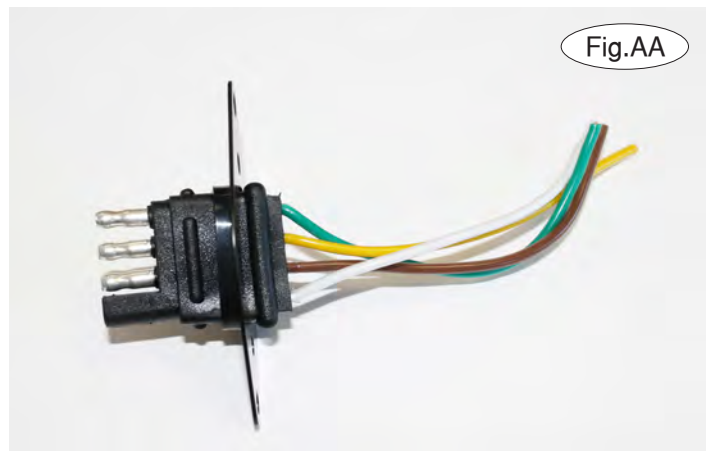

Fig.AA

BOLT TORQUE REQUIREMENTS

Note: The torque values represented below are intended as general guidelines. Torque requirements for specific applications may vary. Roadmaster does not warrant this information to be accurate for all applications and disclaims all liability for any claims or damages which may result from its use.

STANDARD BOLTS

Thread Size	Grade	Torque
5/16.....	5.....	13 ft./lb.
3/8.....	5.....	23 ft./lb.
7/16.....	5.....	37 ft./lb.
1/2.....	5.....	56 ft./lb.
5/8.....	5.....	150 ft./lb.

METRIC BOLTS

Thread Size	Grade	Plated / Unplated
8mm-1.0.....	8.8.....	20 ft./lb. 18 ft./lb.
8mm-1.25.....	8.8.....	19 ft./lb. 18 ft./lb.
10mm-1.25.....	8.8.....	38 ft./lb. 36 ft./lb.
10mm-1.5.....	8.8.....	37 ft./lb. 35 ft./lb.

METRIC BOLTS

Thread Size	Grade	Plated / Unplated
12mm-1.25.....	8.8.....	70 ft./lb. 65 ft./lb.
12mm-1.5.....	8.8.....	66 ft./lb. 61 ft./lb.
12mm-1.75.....	8.8.....	65 ft./lb. 60 ft./lb.
14mm-2.0.....	8.8.....	104 ft./lb. 97 ft./lb.

All illustrations and specifications contained herein are based on the latest information available at the time of publication approval. ROADMASTER, INC. reserves the right to make changes at any time without notice in material, specification and models or to discontinue models.



BASEPLATE KIT INSTALLATION INSTRUCTIONS

KIT #523160-4

ROADMASTER, Inc.

Supplemental Instructions to Remove the Power Steering Cooler

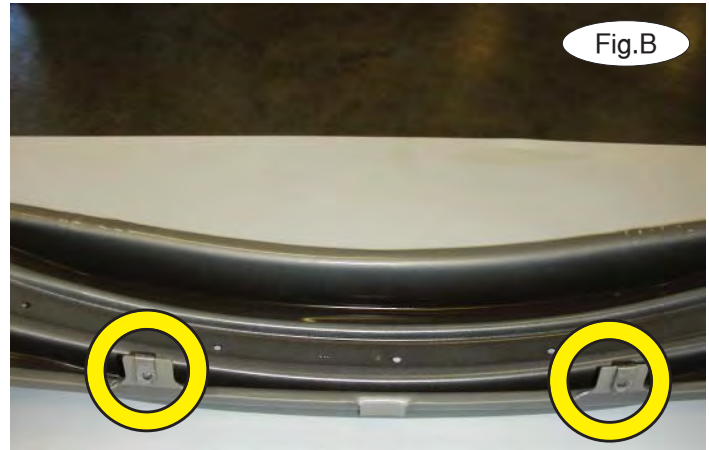
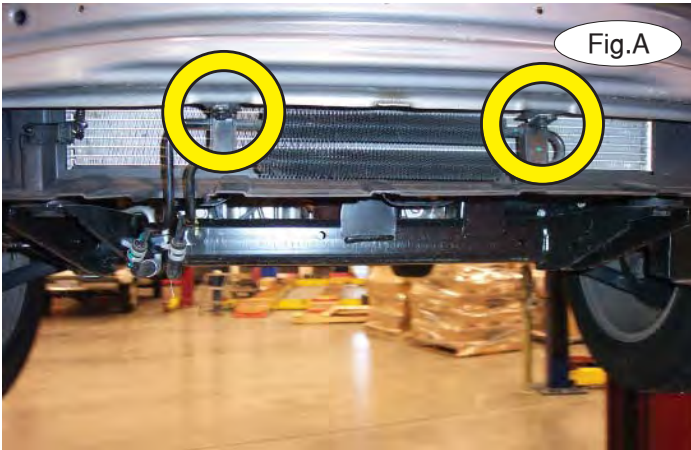

1. Remove the power steering cooler from the bumper core by removing two 10mm (head) bolts (Fig.A).
2. Now, return to the regular instructions to complete steps 6 through 19 before moving on to the next step.
3. Remove the slip nuts from the bumper core (Fig.B).

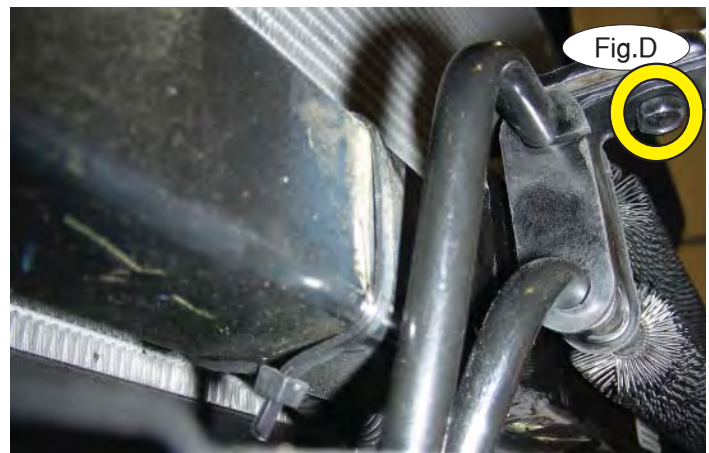

4. Place the slip nuts on the power steering cooler mounting points on the main receiver brace (Fig.C).
5. Bolt the power steering cooler to the mounts on the main receiver brace using the factory bolts you removed in step 1 in these supplemental instructions (Fig.D – passenger side bolt). *Note:* due to manufacturing variances, the vehicle may look slightly different than what you see in Figure D.
6. Now, proceed to steps 20 through 23 in the regular instructions before moving on to the next step.
7. If the power steering cooler lines contact the lower half of the fascia and the backside of the grille opening, use the red lines in Figure E as a guide to trim a small amount of the fascia and the grille to allow for clearance.

