

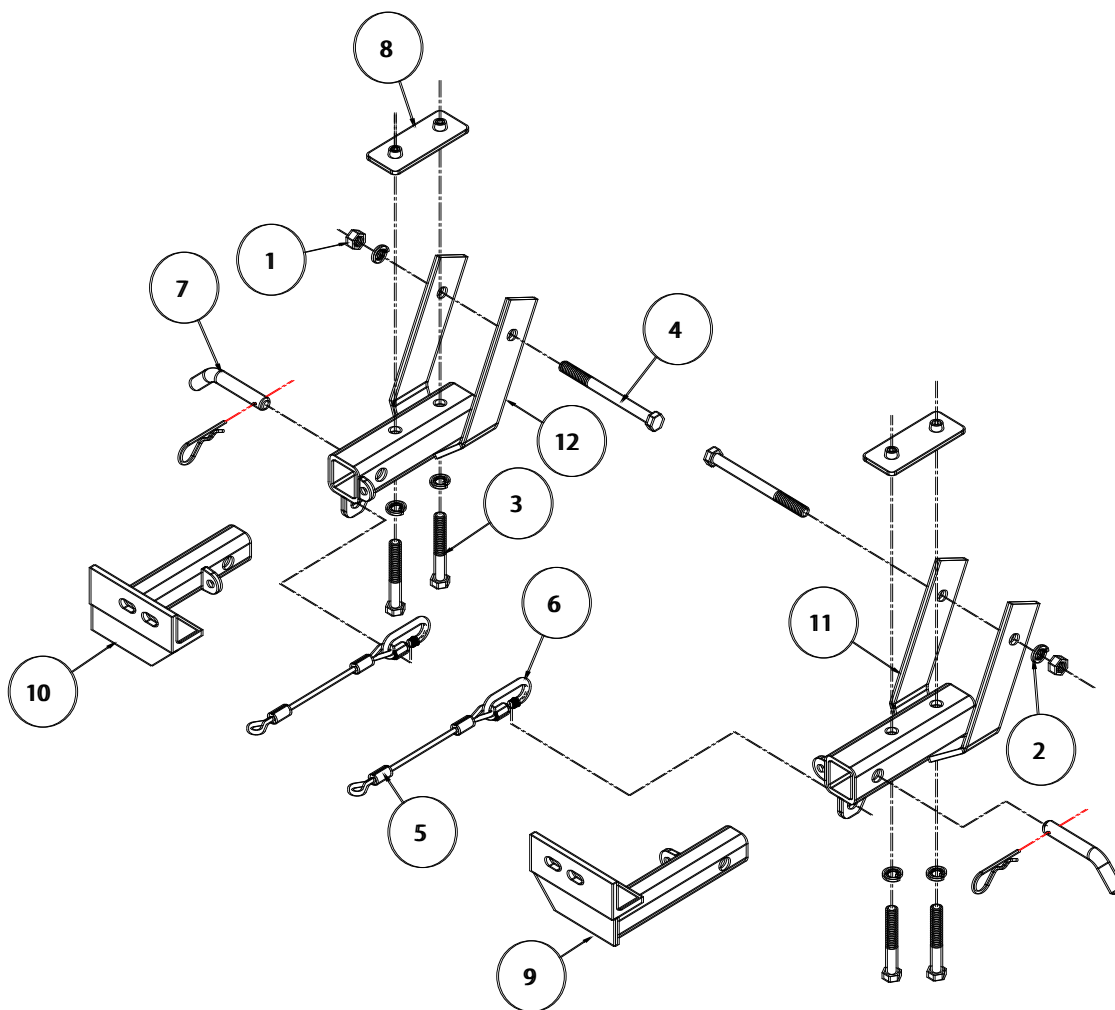

MOUNTING BRACKET KIT INSTALLATION INSTRUCTIONS

KIT# 4410-1
07/13/15



ITEM	QTY	NAME	MATERIAL
1.....	2	1/2" HEX NUT	350258-00
2.....	6	1/2" LOCK WASHER	350309-00
3.....	4	1/2" x 3 1/2" BOLT.....	350103-00
4.....	2	1/2" x 6" BOLT.....	350109-00
5.....	2	8" SAFETY CABLES.....	650648-8
6.....	2	QUICK LINK.....	200008-00
7.....	2	DRAW PIN/SPRING PIN	357035-00
8.....	2	3/16" x 2" x 5" THREADED BACKING PLATE	A-003337
9.....	1	DRIVER SIDE ARM.....	C-001472
10.....	1	PASSENGER SIDE ARM	C-001473
11.....	1	DRIVER SIDE RECEIVER.....	C-001474
12.....	1	PASSENGER SIDE RECEIVER.....	C-001475



MOUNTING BRACKET KIT INSTALLATION INSTRUCTIONS

KIT# 4410-1

07/13/15

This is one of our XL series brackets, which allows the visible front portion of the bracket to be easily removed from the front of the vehicle (Fig.A and Fig.B). The bracket kit consists of a passenger and driver side main receiver brace, two removable front bracket arms and a hardware pack. The main receiver braces mount to the top and bottom of the frame rail and the removable front brackets install in the main receiver braces.

Before starting the installation, lay out the kit components in order, as they will be used. This will give you a visual idea of how the components work, and will also confirm that everything is present and accounted for.



Fig.A



Fig.B

IMPORTANT: All brackets **must** be assembled with all the bolts left loose for final adjustment and positioning (before tightening) unless otherwise instructed. All bolts **must** be torqued for proper strength. If more than one bolt is used per fastening point, the diagram may only show one.

- Use flat washers over all slotted holes
- Use lock washers on all fasteners

ROADMASTER Limited Warranty, including One-Year Conditional Warranty Text and Product Registration Card, in Carton.

WARNING

Failure to follow these instructions can result in property damage, personal injury or even death.

- **Installation of most mounting brackets requires moderate mechanical aptitude and skills.** We strongly recommend professional installation by an experienced installer.
- **The installer must read the instructions and use all bolts and parts supplied.** Failure to do so could result in loss of the towed vehicle.
- **Use Loctite® Red** on all bolts used for mounting this bracket.
- **Every 3,000 miles, the owner must inspect the fasteners** for proper torque, according to the bolt torque requirements chart on the last page of these instructions. **The owner must also inspect all mounts and brackets for cracks or other signs of fatigue every 3,000 miles.** Failure to do so could result in loss of the towed vehicle.
- **The owner must check the vehicle manufacturer's instructions for the proper procedure(s) to prepare the vehicle for towing.** Some vehicles must be equipped with a transmission lube pump, an axle disconnect, driveline disconnect or free-wheeling hubs before they can be towed. Failure to properly equip the vehicle will cause severe damage to the transmission.
- **If running changes were made** by the vehicle manufacturer after this bracket was designed, some bolts or other fasteners in the hardware pack may no longer be the correct size. **It is the installer's responsibility** to verify that the bracket is securely fastened to the vehicle and fitted with the correct hardware to account for these changes. Failure to securely fasten the bracket could result in loss of the towed vehicle.
- If the towed vehicle has been in an accident, it must be properly repaired before attaching the bracket. **Do not install the bracket if any structural frame damage is found.** Failure to repair the damage could result in the loss of the towed vehicle.
- Roadmaster manufactures many styles of brackets. **If your bracket has removable arms, they must be removed before driving the vehicle, unless the arms can be pinned or padlocked in place.** If not secured, the arms could vibrate out, resulting in non-warranty damage or personal injury.
- Some motorhome chassis have such a tight turning radius that you can damage your motorhome, towed vehicle, tow bar or bracket while turning sharply. **Before getting on the road, test your turning radius in an empty parking lot.** Turning too sharply could result in non-warranty damage to towing system, motorhome and/or towed vehicle.
- **Do not back up with the towed vehicle attached** or non-warranty damage will occur to your towing system, motorhome and/or towed vehicle.
- **The safety cables must connect the towing vehicle to the towed vehicle frame to frame, with the cables crossed, with enough slack for sharp turns.** Refer to the cable instructions for proper routing. Failure to leave enough slack in the safety cables, or failure to connect the safety cables frame to frame, will result in the loss of the towed vehicle.
- This bracket is designed for use with ROADMASTER tow bars and ROADMASTER adaptors only. **Using this bracket with other brands, without an approved ROADMASTER adaptor, may result in non-warranty damage or injury.**
- **Do not use this document for custom fabrication,** as it may not show all parts or structural components. Custom fabrication or an attempt to copy this bracket design could result in loss of the towed vehicle.
- Upon final installation, **the installer must inspect the bracket to ensure adequate clearance, particularly around hoses, air conditioner lines, radiators, etc.,** or non-warranty damage to the towed vehicle will result.
- **This bracket is only warranted for the original installation.** Installing a used bracket on another vehicle is not recommended and will void the warranty.



MOUNTING BRACKET KIT INSTALLATION INSTRUCTIONS

KIT# 4410-1

07/13/15

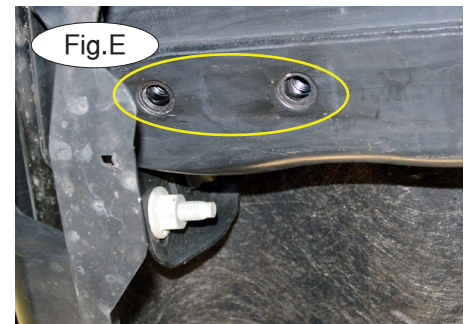
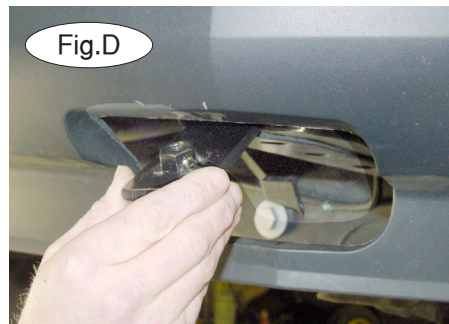

1. **Important:** please use all supplied bolts and parts and read all instructions carefully before beginning this installation. The majority of questions you may have can be answered within the text, and proper installation will ensure safe and secure travel. *Note:* if the vehicle is equipped with tow hooks, you will need to remove them. Do so by removing two 15mm (head) bolts on each side. They will not be replaced. Now, begin the installation.

Working on one side at a time, insert one of the 3/16" x 2" x 5" threaded backing plates into the opening in the front of the frame (Fig.C,D), then align the backing plate with the existing holes in the bottom of the frame (Fig.E).

2. Next, insert one of the main receiver braces through the opening in the grille (Fig.F). Position the main receiver brace so that it aligns flat with the bottom of the frame (Fig.G).

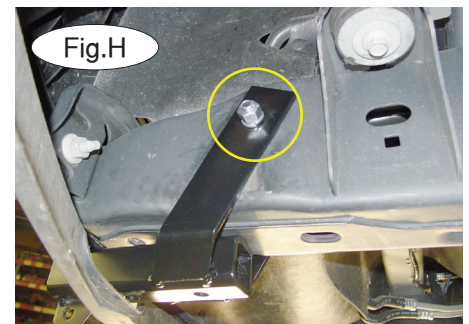
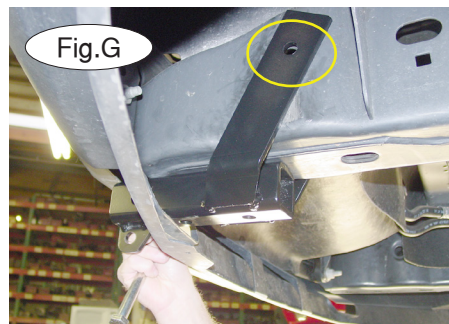
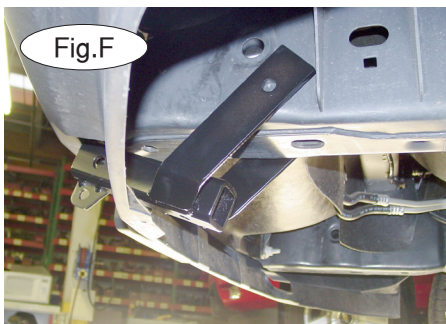

3. Align the side plates of the main receiver brace with the existing holes in the frame (Fig.G). Bolt into place using a 1/2" x 6" bolt, lock washer and nut (Fig.H). *Note:* due to manufacturing variances, later models may have some interference with the splash shielding once the main receiver brace is installed. If this is the case, trim as necessary to allow clearance.

4. Starting with the rear hole in the bottom of the receiver tube, bolt through the receiver tube, frame rail and into the backing plate you inserted in step 1 using the supplied 1/2" x 3 1/2" bolt, 1/2" lock washer and 1/2" nut (Fig.I).

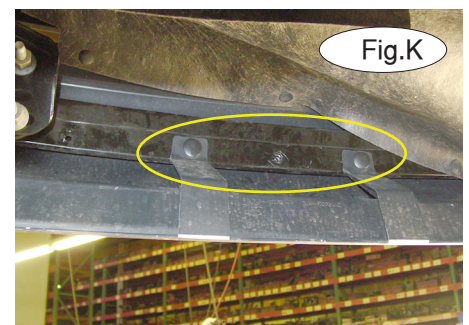
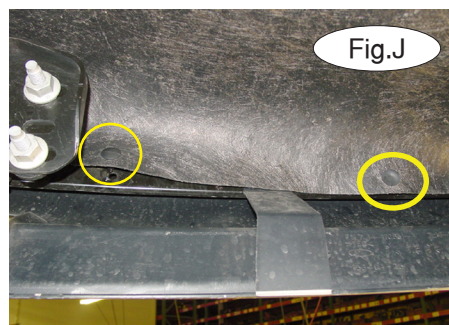
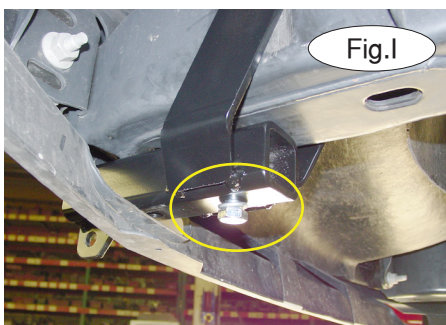

5. Remove two plastic fasteners attaching the air deflector to the bumper core (Fig.J).

6. Next, pull up the air deflector and remove two plastic fasteners attaching the lower fascia to the bumper core (Fig.K).



MOUNTING BRACKET KIT INSTALLATION INSTRUCTIONS

KIT# 4410-1

07/13/15

7. Now, push forward on the fascia to gain access to the front hole in the bottom of the receiver tube. Next, insert the 1/2" x 3 1/2" bolt with lock washer into the front hole (Fig.L), and through the main receiver brace, frame rail and backing plate.

8. Torque all the bolts to the torque specifications listed at the end of these instructions.

9. Repeat steps 1 through 8 for the other side.

10. Replace the plastic fasteners in the air deflector and the fascia, reversing steps 5 and 6.

11. Insert the removable front bracket arms into the front receiver braces, and secure them in place with the supplied 5/8" draw pins and spring pins (Fig.M).

12. Attach the 8" safety cables with the cable connectors (Q-Links) to the front of the receiver braces (Fig.M).

13. Attach the ends of the safety cables to the tow vehicle's safety cables and tow bar.

14. Install the tow bar to the mounting bracket according to the manufacturer's instructions.

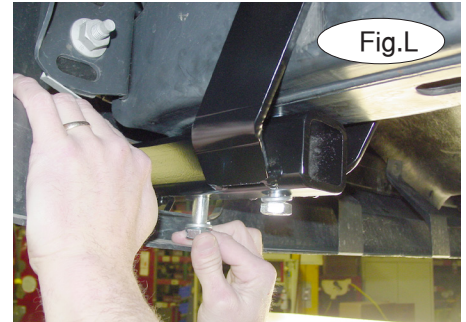

Fig.L

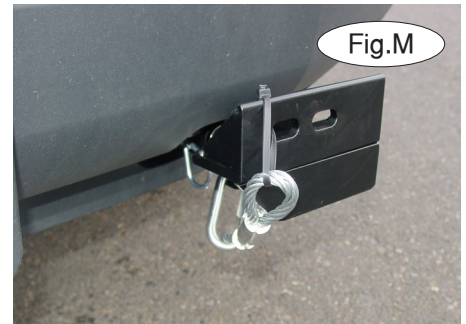

Fig.M

BOLT TORQUE REQUIREMENTS

Note: The torque values represented below are intended as general guidelines. Torque requirements for specific applications may vary. Roadmaster does not warrant this information to be accurate for all applications and disclaims all liability for any claims or damages which may result from its use.

STANDARD BOLTS

Thread Size	Grade	Torque
5/16.....	5.....	13 ft./lb.
3/8.....	5.....	23 ft./lb.
7/16.....	5.....	37 ft./lb.
1/2.....	5.....	56 ft./lb.
5/8.....	5.....	150 ft./lb.

METRIC BOLTS

Thread Size	Grade	Plated / Unplated
8mm-1.0.....	8.8.....	20 ft./lb. 18 ft./lb.
8mm-1.25.....	8.8.....	19 ft./lb. 18 ft./lb.
10mm-1.25.....	8.8.....	38 ft./lb. 36 ft./lb.
10mm-1.5.....	8.8.....	37 ft./lb. 35 ft./lb.

METRIC BOLTS

Thread Size	Grade	Plated / Unplated
12mm-1.25.....	8.8.....	70 ft./lb. 65 ft./lb.
12mm-1.5.....	8.8.....	66 ft./lb. 61 ft./lb.
12mm-1.75.....	8.8.....	65 ft./lb. 60 ft./lb.
14mm-2.0.....	8.8.....	104 ft./lb. 97 ft./lb.