

## Part # 13027199 70-74 Chrysler "E" Body Rear AirBar

### Components:

1	90000611	Driver side upper bar mount
1	90000612	Passenger side upper bar mount
1	90000608	Driver side upper Shockwave mount
1	90000609	Passenger side upper Shockwave mount
2	90000599	Front lower bar mount
2	90000615	Axle mounts
1	90000644	Inner support plate
1	90000610	Brake line spacer
2	90001001	Upper bars – TW 7.375" (9 1/2" C-C length)
2	90001023	Lower bars – WW 21.25"
2	99250001	1/4"-28 straight grease fitting
2	90001589	Threaded Kevlar lined Heim end
2	99752004	3/4"-16 jam nut – for rod end
4	90000552	Aluminum spacer for Heim end
4	90001942	Rubber bushings - pressed into bars and rod ends
4	90001085	Poly bushing for lower bar
2	90000198	Lower bar bushing sleeve
2	90000144	Inner axle tab (Larger)
2	90000155	Outer axle tab
2	90001624	Lower billet Shockwave mount
2	90001617	5/8" shock studs w/ hardware
4	90002067	Aluminum spacer for stud
8	99566002	9/16" SAE hex nut ( For U-bolts )
8	99566003	9/16" SAE flat washer ( For U-bolts )
4	99566004	U-bolts - Axle mount
2	70010694	Jig brackets for upper bar installation

### Hardware: (Part # 99010022)

2	1/2"-13 x 1 1/4" Gr. 5 bolt	Billet mount to axle bracket
2	1/2"-13 x 1 3/4" Gr. 5 bolt	Billet mount to axle bracket
4	1/2"-13 Gr. 5 Nylok nut	Billet mount to axle bracket
1	5/16"-18 x 1 3/4" Gr. 5 bolt	Brake line & spacer
1	5/16" SAE flat washer	Brake line & spacer
1	5/16" lock washer	Brake line & spacer
2	1/2"-13 x 2 3/4" Gr.5 bolt	Upper Shockwave mount to body
2	1/2"-13 Nylok nut	Upper Shockwave mount to body
4	1/2" SAE flat washer	Upper Shockwave mount to body
4	5/8"-11 x 4" Gr. 5 bolt	Shockwave to upper mount & front bar to body
2	5/8"-11 Gr. 5 Nylok nut	Shockwave to upper mount
6	5/8" SAE flat washer	Shockwave to upper mount
6	5/8"-11 x 2 3/4" Gr. 5 bolt	Upper & lower bars
8	5/8"-11 Nylok jam nut	Upper & lower bars
26	3/8"-16 x 1" thread forming bolt	Shockwave and upper bar mounts to frame
8	3/8"-16 x 1 1/4" Gr. 5 bolt	Lower front bar mount
6	3/8"-16 x 1" Gr. 5 bolt	Inner support plate
4	3/8"-16 x 2 1/4" Gr. 5 bolt	Inner support plate
18	3/8"-16 Nylok nut	Inner support plate
48	3/8" SAE flat washers	Shockwave and upper and lower bar mounts
2	3/8"-16 x 3/4" Gr. 5 bolt	Upper bar installation jig
2	3/8"-16 nut	Upper bar installation jig

# **AirBAR**<sup>®</sup>

by Air Ride Technologies

1. Raise the vehicle to a safe and comfortable working height. Use jack stands to support the vehicle with the suspension hanging freely.
2. Support the axle and remove the leaf springs, front leaf spring mounts, shocks, tail pipes, bump stops, sway bar and pinion snubber. Refer to the factory service manual for proper disassemble procedures. Save the hardware for the bump stops and pinion snubber, they will be reused.

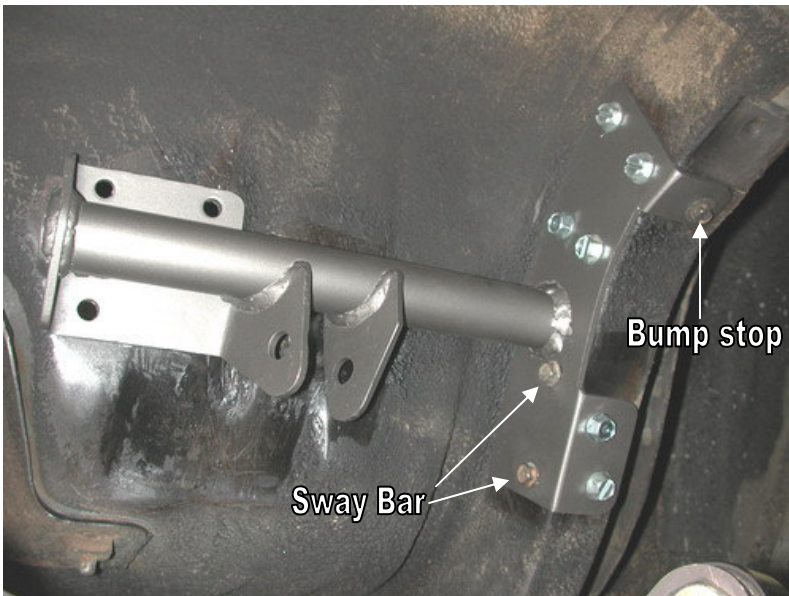

3. Place the upper bar mount up to the body. It will align off of the two sway bar mount holes and the front bump stop mount hole.

4. Mark and drill the remaining 6 holes in the frame with a 5/16" bit. The 3 holes in the body will be drilled with a 3/8" bit. Six 3/8" x 1" thread forming bolts and flat washers will secure the mount to the frame.

5. On the driver side you will have to temporarily remove the brake line body mount.

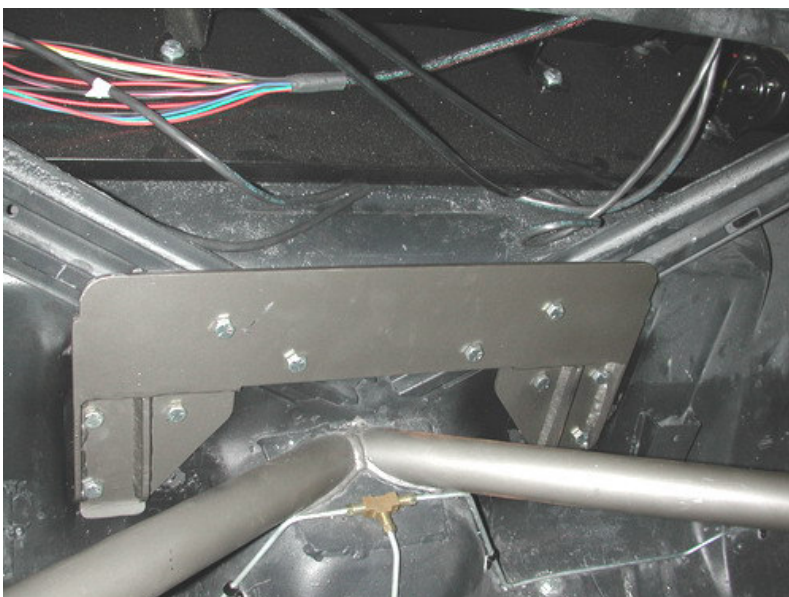

6. The inner support plate will bolt to the floor pan on the inside of the car using six 3/8" x 1" bolts, Nyloks and flat washers. The remaining 4 holes will need to be drill and will use 3/8" x 2 1/4" bolts, Nyloks and flat washers.



7. Using the supplied U-bolts, fasten the lower axle bracket to the factory leaf spring pad.

8. Bolt the lower Billet Shockwave mount to the axle bracket using a  $\frac{1}{2}$ " bolts and Nyloc nuts. Position the mount in the middle two holes.

**Note:** It is easier to tighten these nuts before installing the lower bar.



9. Bolt the new front lower bar mount to the body using 4  $\frac{3}{8}$ " x  $1\frac{1}{4}$ " bolts, 8 flat washers and 4 Nyloc nuts.

10. Attach the large end of the lower bar to the mount using a  $\frac{5}{8}$ " x 4" bolt and Nyloc nut. This bushing is polyurethane and is lubricated with lithium grease at the factory. Future lubrication can be done with any non-petroleum based lubricant.

**Note:** Do not tighten any bar mounts until the axle is at ride height.

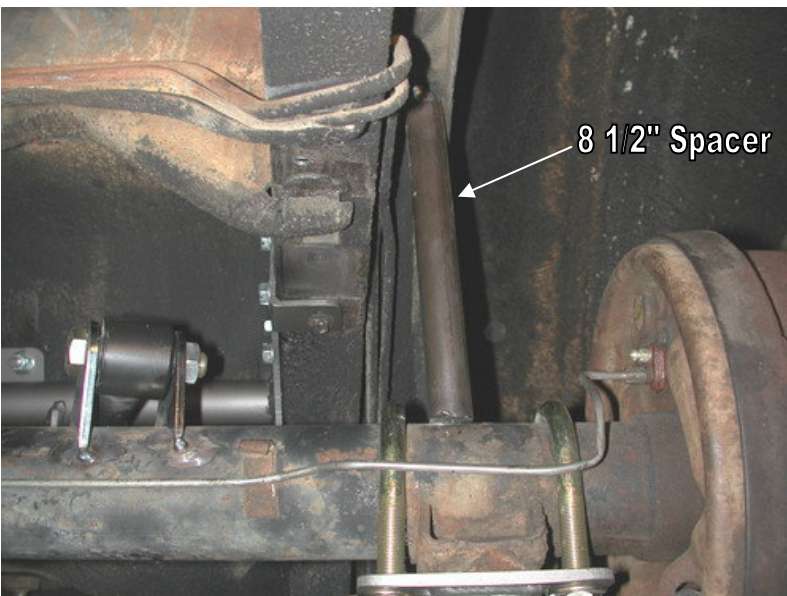

11. Bolt the axle tabs to one end of the upper bar ( $9\frac{1}{2}$ " C-C) using a  $\frac{5}{8}$ " x  $2\frac{3}{4}$ " bolt and Nyloc nut. The larger tab will go to the inside of the car and the longer point on both tabs will go to the front of the car. Bolt the other end of the bar to the upper mount also using a  $\frac{5}{8}$ " x  $2\frac{3}{4}$ " bolt and Nyloc nut.

12. Before welding the tabs to the axle pinion angle must be set; the axle must be centered between the rails; and the axle must be raised to ride height. One trick to help maintain these setting is to tack weld a **temporary**  $8\frac{1}{2}$ " spacer between the body and the axle.

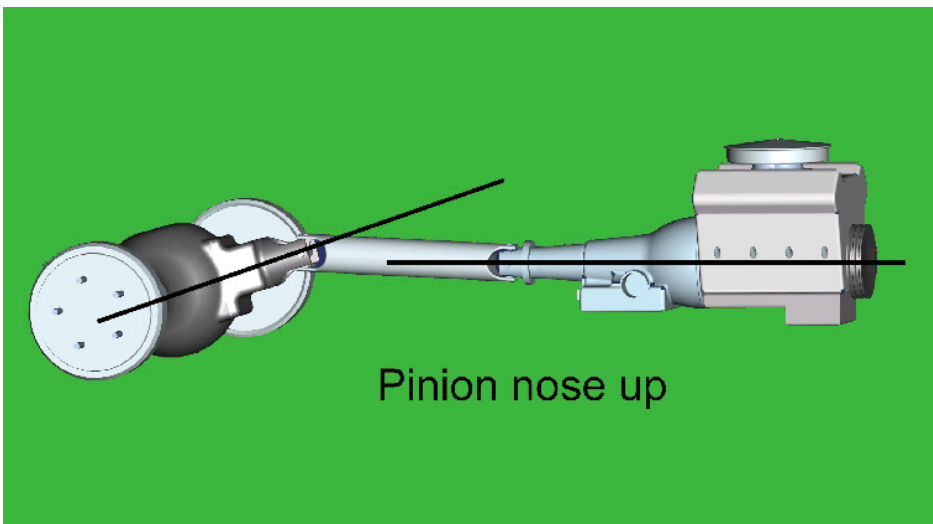
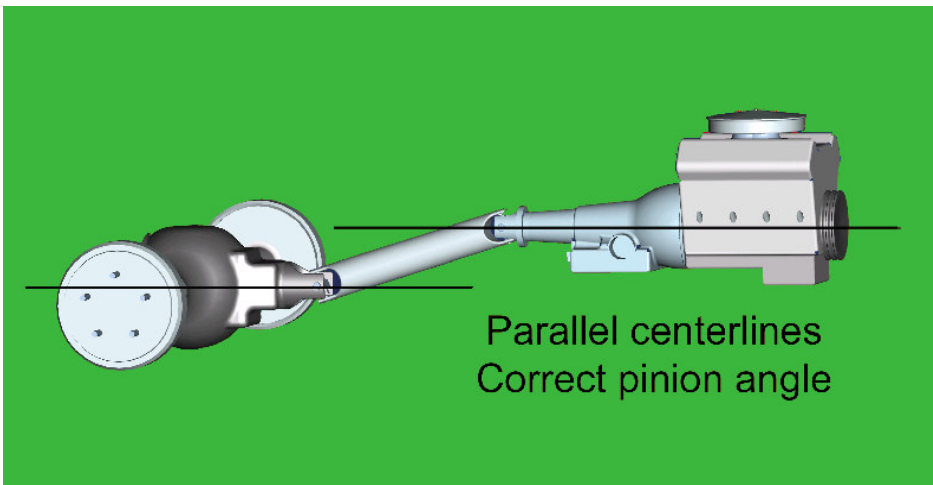
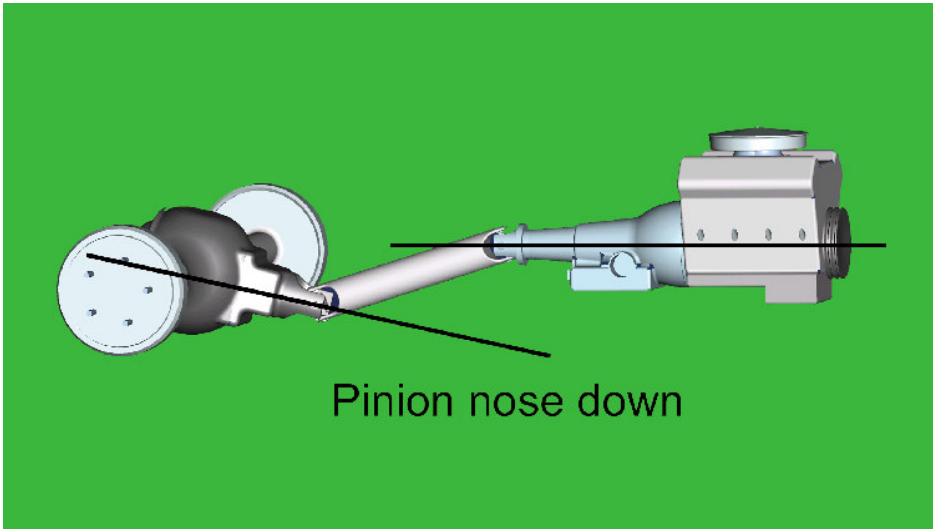

13. How do you set the pinion angle? On a single-piece shaft you want to set it up where a line drawn through the center of the engine crankshaft or output shaft of the transmission and a line drawn through the center of the pinion are parallel to each other but not the same line.

A simple way to do this is to place a digital angle finder or dial level on the front face of the lower engine pulley or harmonic balancer. This will give you a reading that is 90 degrees to the crank or output shaft unless you have real problems with your balancer. At the other end, you can place the same level or angle finder against the front face of the pinion yoke that is also at 90 degrees to the centerline. If you rotate the yoke up or down so both angles match, you have perfect alignment.

Road testing will tell you if you have it right. If you accelerate and you get or increase a vibration, then the pinion yoke is too HIGH. Rotate it downward in small increments of a degree or two until the problem goes away. If you get or increase a vibration when decelerating, then the pinion yoke is too LOW. Rotate it upward to correct it.

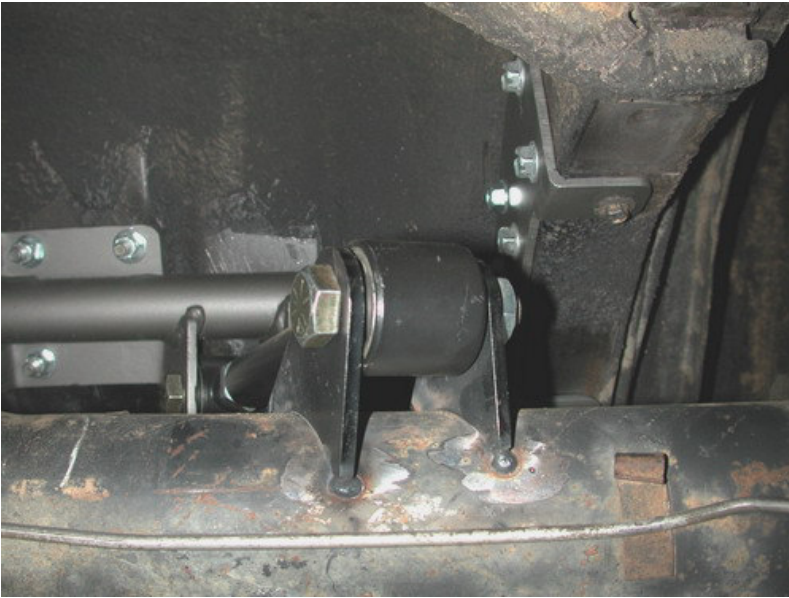

14. Once pinion angle, axle center and ride height are double-checked the tabs can be tack-welded to the axle. Then remove the bar (to avoid frying the bushings) and weld the tabs solid. Weld 1" at a time and skip around to avoid warping the axle. Reattach the bar to the axle.



15. Attach the upper Shockwave mount to the factory upper shock mount using a  $\frac{1}{2}$ " x  $2 \frac{3}{4}$ " bolt, Nyloc nut, and flat washers. Swing the bracket out to the frame rail to mark and drill 5 holes in the frame with a  $\frac{5}{16}$ " bit. Fasten with  $\frac{3}{8}$ " x 1" thread forming bolts and flat washers.

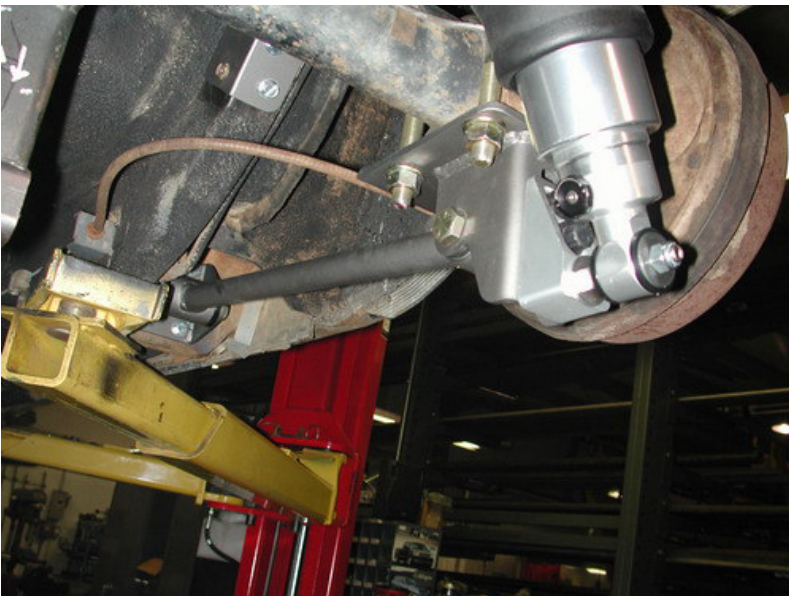

16. Apply thread sealant to a 90 degree air fitting and screw it into the top of the Shockwave. These pictures show the 9000 series Shockwave, but this kit will use the 7000 series.

17. Screw the lower shock stud into the billet mount. Slide the Shockwave over the stud with a large washer on each side of the bushing. Secure the unit with the Nyloc nut supplied with the kit.

**Note:** Position the valve adjustment knob so that it can be accessed easily. Approximately 3 clicks will be a good starting point but will vary to driver preference.



18. Insert a 5/8" x 4" bolt through the upper mount and Shockwave eye. There should be a 5/8" flat washer on each side of the poly bushing and one next to the head of the bolt. Fasten the assembly with a 5/8" Nyloc nut.

19. All of the bar mounts can now be tightened.

20. Remove the 8 1/2" spacer.

21. Ride height on this unit is 13", should be around 75 psi, but will vary to vehicle weight and driver preference.



22. To remount the brake line body mount the 1" spacer is require to allow clearance with the upper bar mount. A longer 5/16" x 1 3/4" bolt, flat washer and lock washer are also supplied.

23. Double-check to make sure nothing can rub the Shockwave at any point through full suspension travel. **Allowing the air spring to rub will cause failure and is not a warrantable situation.**

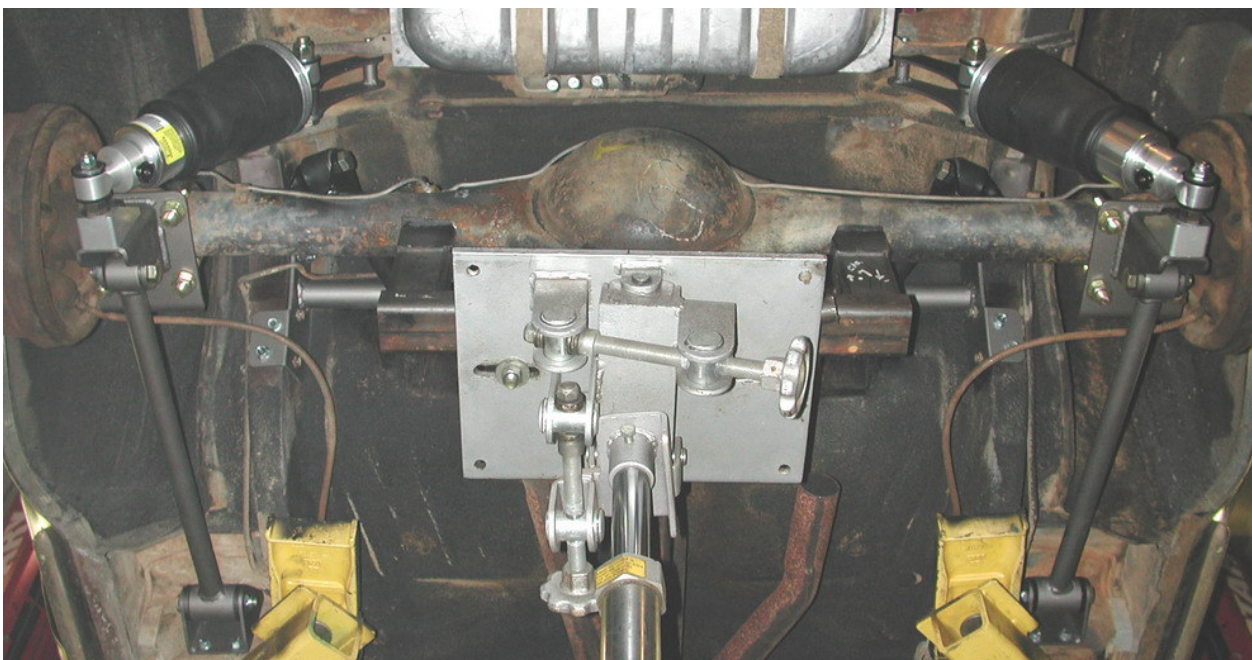

## Upper Bar Installation Jig

- This jig has been supplied to aid in the installation of the upper 4 link bar. It can be temporarily used to properly align, locate and weld the tabs onto the axle. It will also ensure that the mounting bolts are parallel to the ground.
- Follow the diagram below to set the jig to the same length as the upper bar, use the 3/8" x 3/4" bolt and nuts to set the length.
- Position the axle at ride height. Center the axle left to right between the quarter panels. Set pinion angle.
- Bolt one end of the jig to the cradle using a 5/8" x 2 3/4" bolt.
- Using another 5/8" x 2 3/4" bolt, fasten the axle tabs to the other end. The tabs must be bolted to the **outside** of the jig.
- Swing the bar down letting the tabs rest onto the axle. Trim the brackets as necessary to minimize the gap to be welded.
- Check pinion angle, ride height and axle center. Tack-weld the tabs in place.
- Remove jig and install upper bar.
- Repeat this process for the other side.
- Recheck pinion angle, ride height and axle center. (Sound familiar?)
- After the tabs have been tack welded on both sides, remove the upper bars to avoid melting the rubber bushings. Let the axle drop down for better access to the tabs. Lay 1" welds on the inside and outside of the tabs. Skip around from one side to the other to avoid overheating the tube.

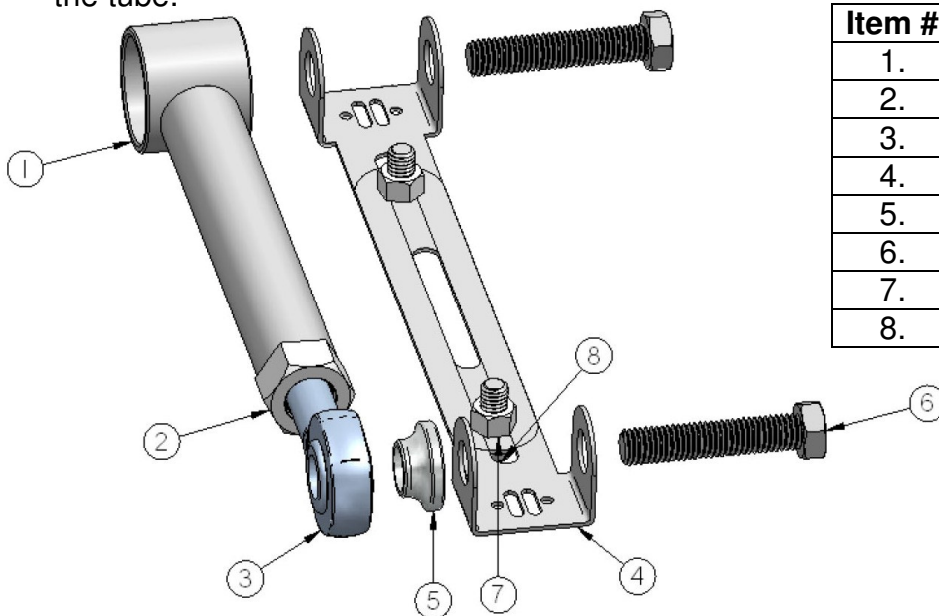

Item #	Description
1.	Upper bar
2.	3/4"-16 jam nut
3.	Heim end
4.	Alignment jig
5.	Aluminum spacer
6.	5/8"-11 x 2 3/4" bolt
7.	3/8"-16 nut
8.	3/8"-16 x 3/4" bolt





## Should I weld my AirBar 4 link assembly in?

Since we get this question quite often, it deserves a proper explanation.

The AirBar has been designed for bolt-in installation. We have paid special attention to interfacing with key structural areas of each vehicle, fastening bracketry in at least two planes to properly distribute load paths, and to using appropriate fasteners that roll, rather than cut, threads into the vehicle structure.

Having said that, you could potentially encounter a vehicle that has rust or collision damage in these areas. Or maybe you intend to consistently place the vehicle in severe racing applications with sticky racing slicks and high speed corners. In these cases it is perfectly acceptable to weld the AirBar components into your vehicle. Even in these severe cases we recommend that you install the entire AirBar assembly first [including the fasteners], and then use short 1" long tack welds to secure your installation. Remember that the vehicle structure metal is typically much thinner [.060"-.120" ] than the .188" thick AirBar brackets. If you burn through the vehicle sheet metal structure you may end up with an installation that is weaker than before you tried to weld it.

The other reason to weld in your AirBar assembly is...you simply want to. You're a welding kind of guy...that's the way you've always done it...you have the skills and equipment to do it. In that case...weld away with our blessing!