



**Part # 12167199**  
**60-64 Galaxie Rear AirBar**

**Components:**

2	90000568	Lower axle mount spacer
2	90000515	Lower axle mount
1	90000567	Upper cradle assembly
2	90001624	Lower billet Shockwave mount
2	90001617	Lower Shockwave stud
4	90002067	Aluminum spacer for stud
2	90000144	Axle tabs
2	90000524	Axle tabs
2	90000946	Upper bars – TW 10.125" (C-C length 12.0")
2	90001028	Lower bars – WW 23.25"
2	99250001	1/4"-28 straight grease fitting
4	90001085	Poly bushing for lower bar
2	90001094	Bushing Sleeve for lower bar
2	90001589	Threaded Kevlar lined Heim end
2	99752004	3/4"-16 jam nut – for rod end
4	90000552	Aluminum spacer for Heim end
4	90001942	Rubber bushings pressed into bars and rod ends
4	99566001	U-Bolts / nuts & washer - Lower axle bracket
2	70010694	Jig brackets for upper bar installation

**Hardware Kit: (Part # 99010020)**

2	1/2"-13 x 1 1/4" Gr. 5 bolt	Billet mount to axle bracket
2	1/2"-13 x 1 3/4" Gr. 5 bolt	Billet mount to axle bracket
4	1/2"-13 Nylok nut	Billet mount to axle bracket
6	5/8"-11 x 2 3/4" Gr.5 bolt	Bar ends
6	5/8"-11 Nylok jam nut	Bar ends
2	1/2"-13 x 2 1/4 Gr.5 bolt	Upper Shockwave mount
2	1/2"-13 Nylok jam nut	Upper Shockwave mount
16	3/8"-16 x 1" Thread forming bolt	Upper cradle assembly
16	3/8" SAE flat washer	Upper cradle assembly
2	3/8"-16 x 3/4" Gr. 5 bolt	Upper bar installation jig
2	3/8"-16 nut	Upper bar installation jig

# **AirBAR<sup>®</sup>**

*by Air Ride Technologies*

1. Raise the vehicle to a safe and comfortable working height. Use jack stands to support the vehicle with the suspension hanging freely.
2. Support the axle and remove the leaf springs, shocks, pinion snubber and tail pipes. Refer to the factory service manual for proper disassemble procedures. Keep the factory front leaf spring mounting bolts; they will be reused.



3. On the inside of the frame rail there are two tabs that must be ground smooth.



4. You must also trim these grooves in the pan at a 45 deg. angle to allow the upper cradle assemble to slide into place. They are located just in front of the axle above the crossmember.

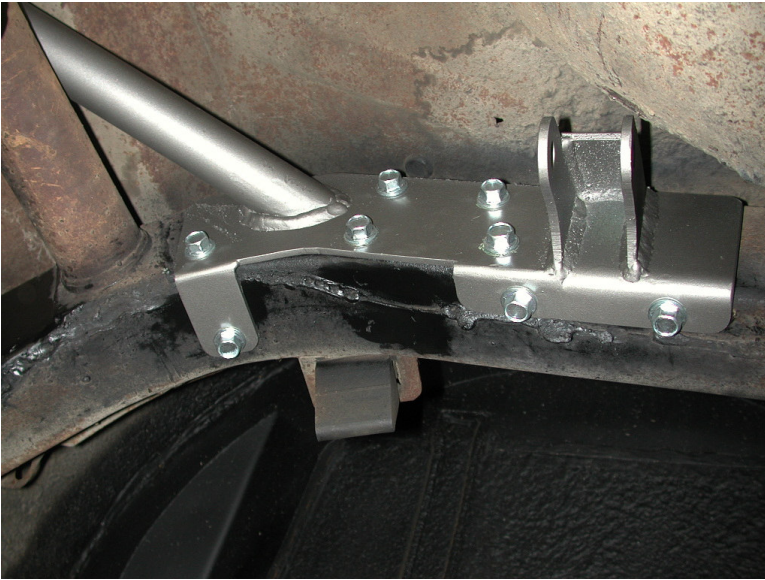

5. Slide the cradle into place with the upper Shockwave mount toward the rear of the vehicle.

6. You may need to grind the welds smooth on the bottom of the frame to allow the cradle to sit properly.

7. The bolt hole just in front of the Shockwave mount will align with a hole in the frame to position the cradle. Drill the rest of the holes with a 5/16" bit one at a time while threading in a 3/8" x 1" self-tapping bolt. Be careful not to over tighten these bolts.



8. Bolt the large end of the lower bar (longer one) in the factory leaf spring mount using the factory bolts.

9. This bushing is polyurethane and is lubricated at the factory. Future lubrication can be done with any non-petroleum based lubricant. All other bushings are rubber and do not require lubrication.

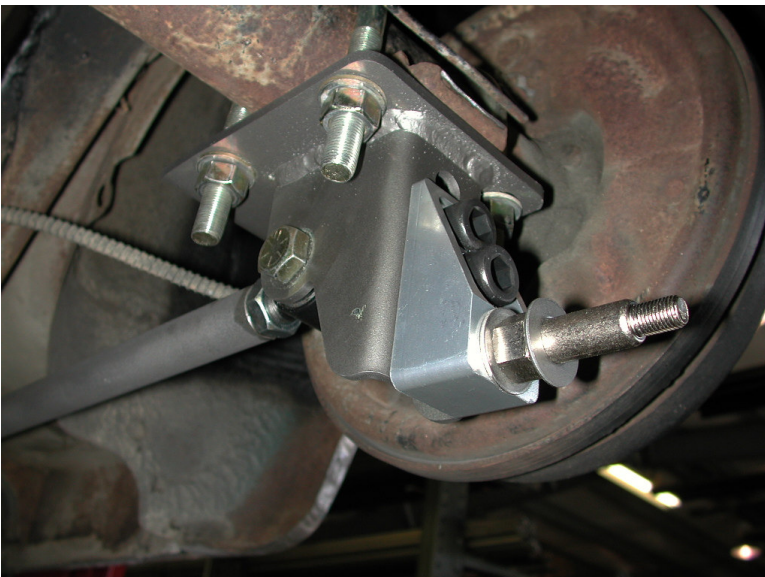

10. Secure the axle mount to the leaf spring pad using the supplied U-bolts. There is an aluminum bushing that will slide over the alignment pin.

11. Bolt the lower Shockwave mount to the axle mount using the 1/2" bolts.

12. Apply anti-seize to the shock stud and screw it into the lower shockwave mount.

13. Swing the lower bar up to the axle mount and insert a 5/8" x 2 3/4" bolt and nyloc. This bar should measure 23 1/4" C-C. **Do not tighten any bolts yet.**

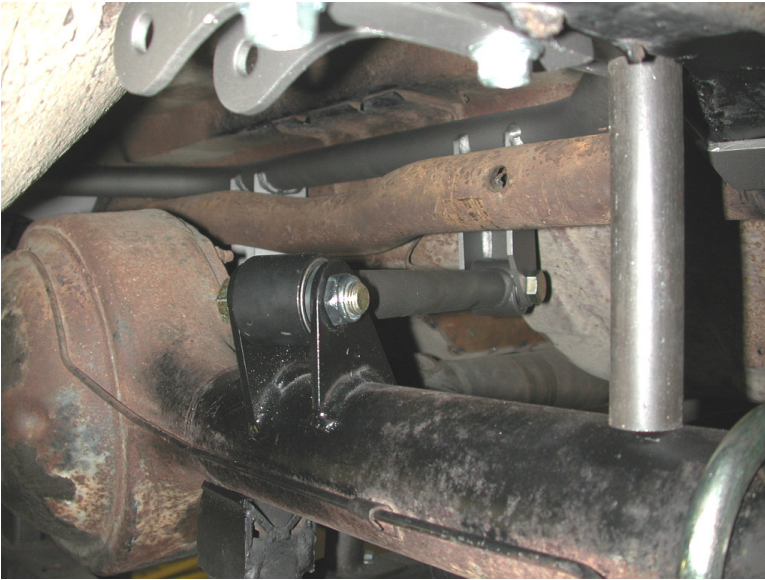

14. Bolt the axle tabs to the upper bar using a 5/8" x 2 3/4" bolt and nyloc as shown in the picture. The upper bar should measure 12" C-C.

15. Bolt the other end into the upper cradle and let the tabs rest on top of the axle. **Do not weld yet.** You must first set pinion angle (which is explained on the next page) and center the axle.

16. Centering the axle is best done by hanging a plum off of the axle and measuring out to the axle flange.



17. This must all be set at **ride height**, which will occur with 14.5" from c-c on the Shockwave mounts. As you can see in the above picture, we have tack welded a 5" long spacer between the axle and frame to maintain ride height, axle center, and pinion angle while welding in the tabs.

18. Make sure to remove the upper bars before welding the tabs to avoid frying the bushings.

You can now tighten all of the 4 link bolts with the car at ride height.



19. Apply thread sealant to the air fitting and screw it into the top of the Shockwave.

20. Attach the top of the Shockwave to the cradle with a 1/2" x 2 1/4" bolt and nyloc. Place the washer over the shock stud, and then slide the Shockwave over the stud. Another washer and nyloc will hold in tight.

21. Remove the spacer.

22. Double-check all clearances with parking brake cable, vent tubes, brake lines, etc.

23. Ride height should be around 70psi but will vary to driver preference.

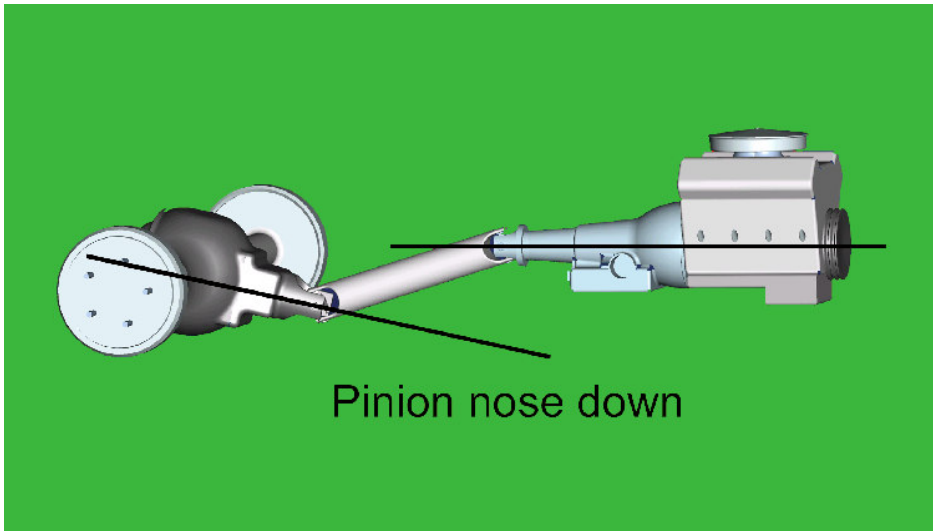

Pinion nose down

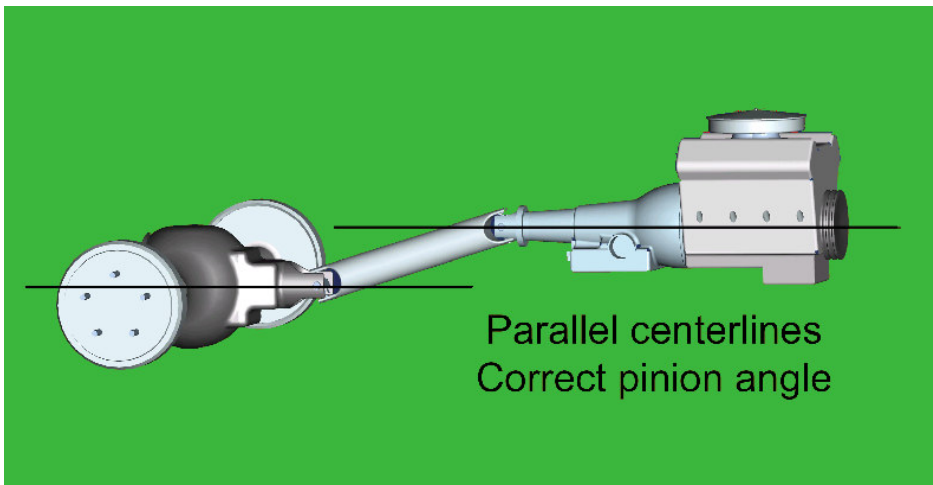

Parallel centerlines  
Correct pinion angle

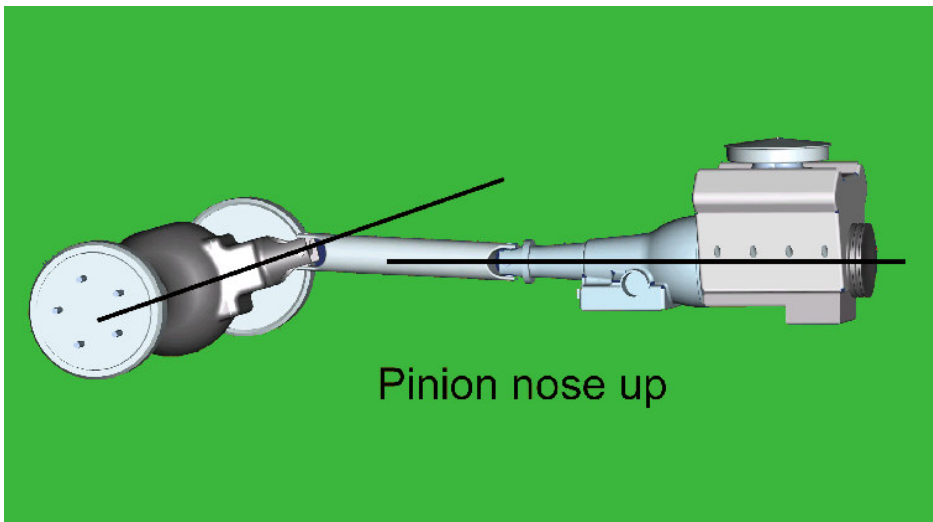

Pinion nose up

How do you set the pinion angle? On a single-piece shaft you want to set it up where a line drawn through the center of the engine crankshaft or output shaft of the transmission and a line drawn through the center of the pinion are parallel to each other but not the same line.

A simple way to do this is to place a digital angle finder or dial level on the front face of the lower engine pulley or harmonic balancer. This will give you a reading that is 90 degrees to the crank or output shaft unless you have real problems with your balancer. At the other end, you can place the same level or angle finder against the front face of the pinion yoke that is also at 90 degrees to the centerline. If you rotate the yoke up or down so both angles match, you have perfect alignment.

Road testing will tell you if you have it right. If you accelerate and you get or increase a vibration, then the pinion yoke is too HIGH. Rotate it downward in small increments of a degree or two until the problem goes away. If you get or increase a vibration when decelerating, then the pinion yoke is too LOW. Rotate it upward to correct it.

## Upper Bar Installation Jig

- This jig has been supplied to aid in the installation of the upper 4 link bar. It can be temporarily used to properly align, locate and weld the tabs onto the axle. It will also ensure that the mounting bolts are parallel to the ground.
- Follow the diagram below to set the jig to the same length as the upper bar, use the 3/8" x 3/4" bolt and nuts to set the length.
- Position the axle at ride height. Center the axle left to right between the quarter panels. Set pinion angle.
- Bolt one end of the jig to the cradle using a 5/8" x 2 3/4" bolt.
- Using another 5/8" x 2 3/4" bolt, fasten the axle tabs to the other end. The tabs must be bolted to the **outside** of the jig.
- Swing the bar down letting the tabs rest onto the axle. Trim the brackets as necessary to minimize the gap to be welded.
- Check pinion angle, ride height and axle center. Tack-weld the tabs in place.
- Remove jig and install upper bar.
- Repeat this process for the other side.
- Recheck pinion angle, ride height and axle center. (Sound familiar?)
- After the tabs have been tack welded on both sides, remove the upper bars to avoid melting the rubber bushings. Let the axle drop down for better access to the tabs. Lay 1" welds on the inside and outside of the tabs. Skip around from one side to the other to avoid overheating the tube.

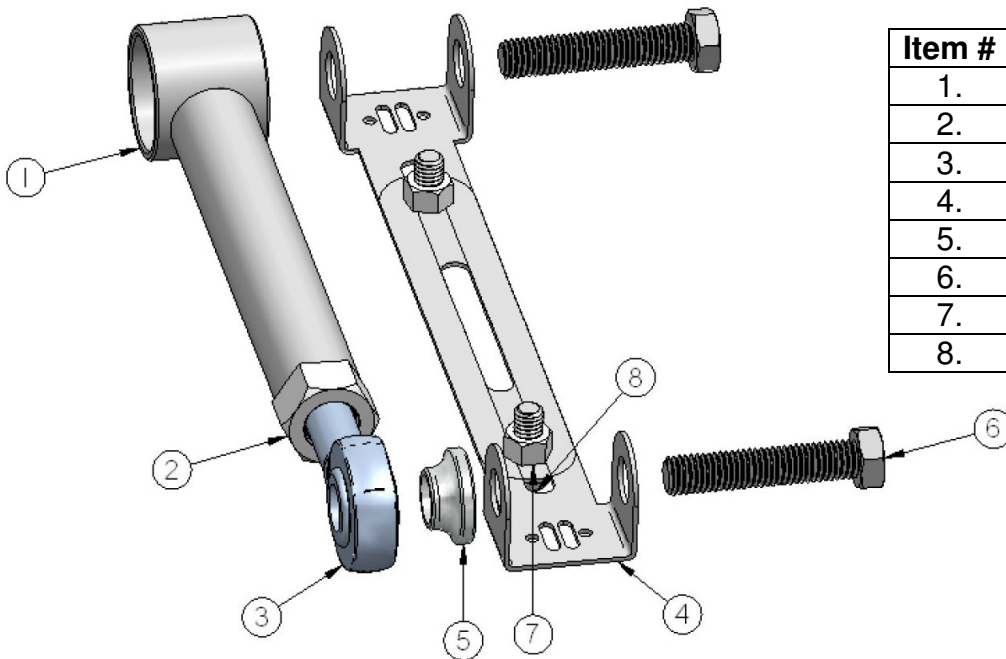

Item #	Description
1.	Upper bar
2.	3/4"-16 jam nut
3.	Heim end
4.	Alignment jig
5.	Aluminum spacer
6.	5/8"-11 x 2 3/4" bolt
7.	3/8"-16 nut
8.	3/8"-16 x 3/4" bolt

