



RHINO-RACK

Rhino Bonnet/ Boot Anchor Straps (RBAS)

Important: Please read these instructions carefully prior to installation. Please refer to your fitting instruction to ensure that the anchor strap is installed in the correct location. Check the contents of kit before commencing fitment and report any discrepancies. Place these instructions in the vehicle's glove box after installation is complete.

Layout



This product is designed to aid in the safety of transporting long items (i.e. Kayaks) and not to be used for towing or pulling applications. Special consideration must be taken when selecting your fixing point. Rhino-Rack Pty Ltd does not take any responsibility for damage to the vehicle that may be caused by this product on paintwork, panels and fixing hardware. Although they are designed with the softest materials in mind to minimise this damage, they cannot take into consideration the variation of panel gaps and wind flapping issues. It is the users responsibility to ensure that the strap is used in accordance with these fitting instructions.

Parts List

Item	Component Name	Qty	Part No
1	Anchor Strap	1	RBAS
3	Fitting Instruction	1	R302

Care Instruction: Wash and clean vehicle roof racks prior to fitment

Warning:

It is important that all roof racks and accessories are installed and attached correctly. Failure to follow the correct attachments could result in an accident, serious injury or death to others. The driver of the vehicle is responsible for securing the roof racks and accessories, checking the attachments, periodically checking bolt torque and visual inspection of all components for wear and damage. Do not attempt to fit the roof rack system or accessory to your vehicle unless you fully understand these fitting instructions. Please direct any questions regarding fitting to the dealer or retailer from where they were purchased.

Use only non-stretch fastening ropes or straps.





Rhino Bonnet/ Boot Anchor Straps (RBAS)

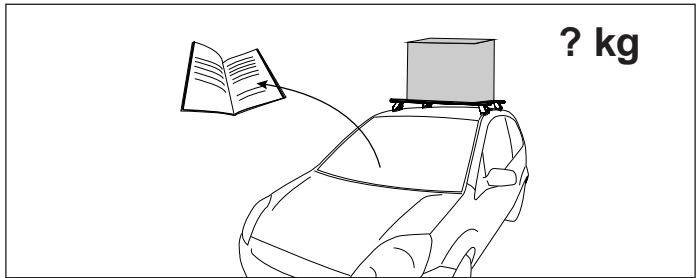
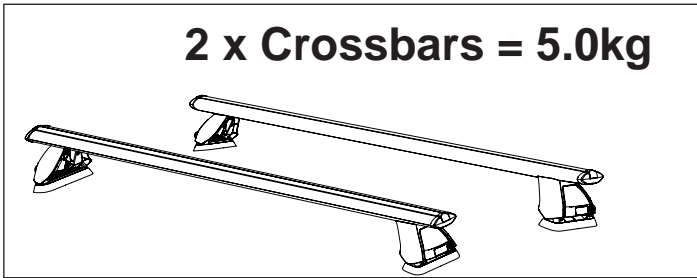
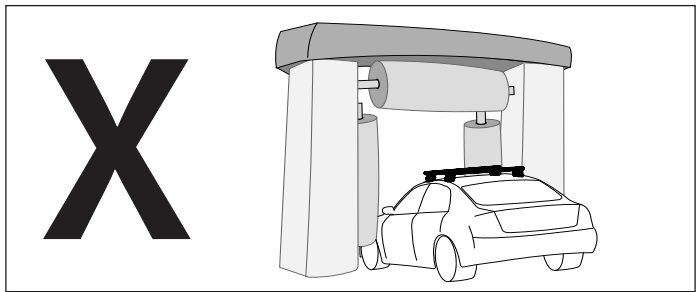
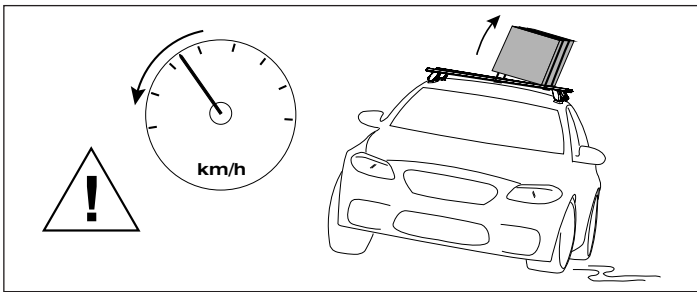
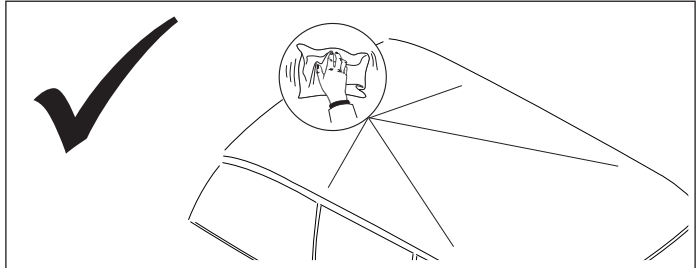
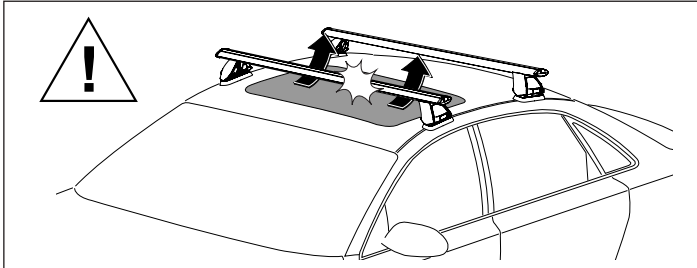
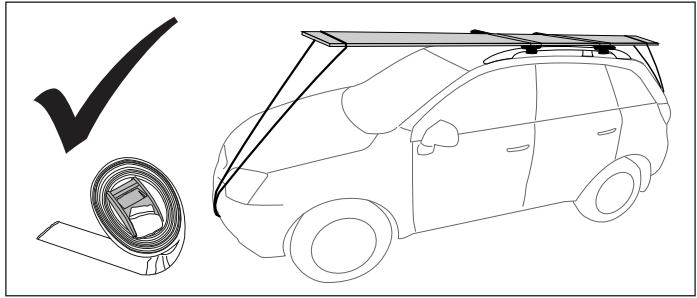
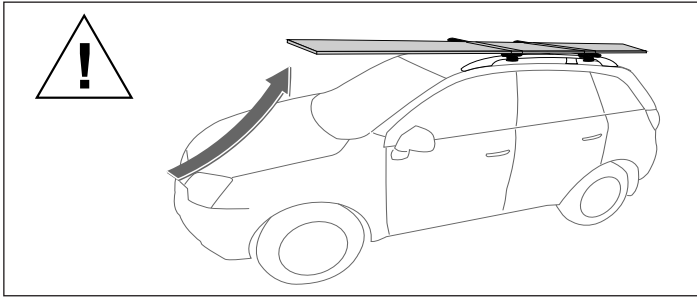

When these roof racks are to be used on a vehicle that is driven off sealed roads, the manufacturer maximum roof load rating (to be found in the vehicles User Manual) should be **halved**. Do not forget to subtract 7.5kg from your maximum carrying capacity due to the weight of the crossbars and legs.

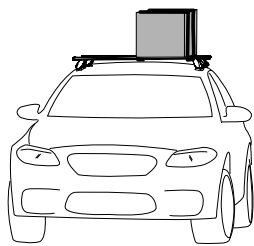

60kg load rating (Urban road) = **30kg load rating** (Off road - 60kg / 2)

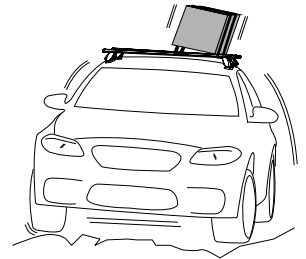

WARNING! Important Load Carrying Instructions

With utility vehicles, the cabin and the canopy move independently. Roof racks and vehicle can be damaged if the item transported is rigidly fixed at points on both the cabin and canopy. Instead, rigidly fix to either the cabin roof racks or the canopy roof racks.

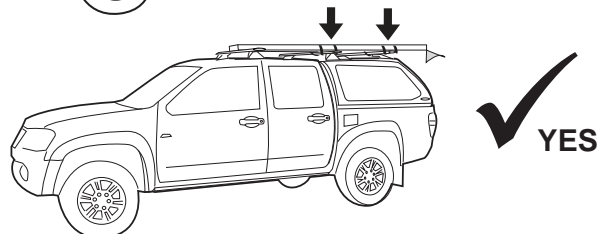
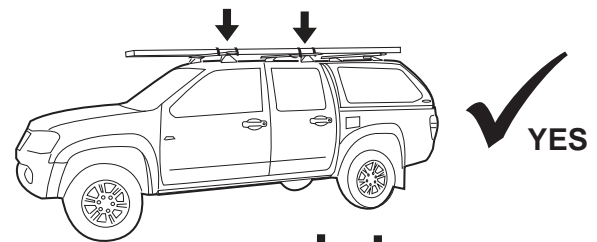
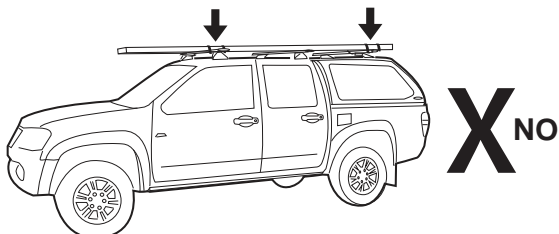



Rhino Bonnet/ Boot Anchor Straps (RBAS)

Fitting instructions for use with Pioneer Tray

1 Open bonnet and find a suitable spot.

Find a vacant space in the engine bay away from hot objects. This anchor strap should not be attached to any plastic parts such as brackets for headlights.

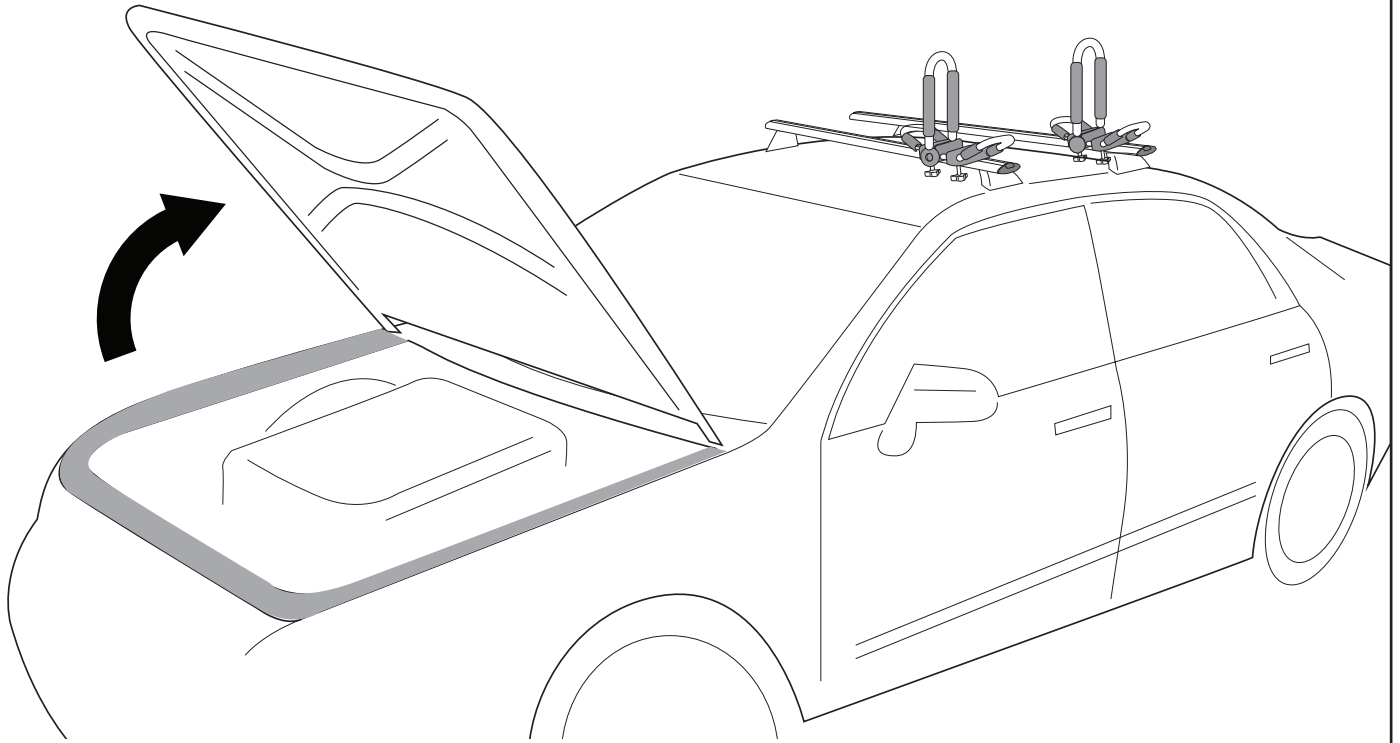

2 Place anchor strap with the strap pointing out of the car.

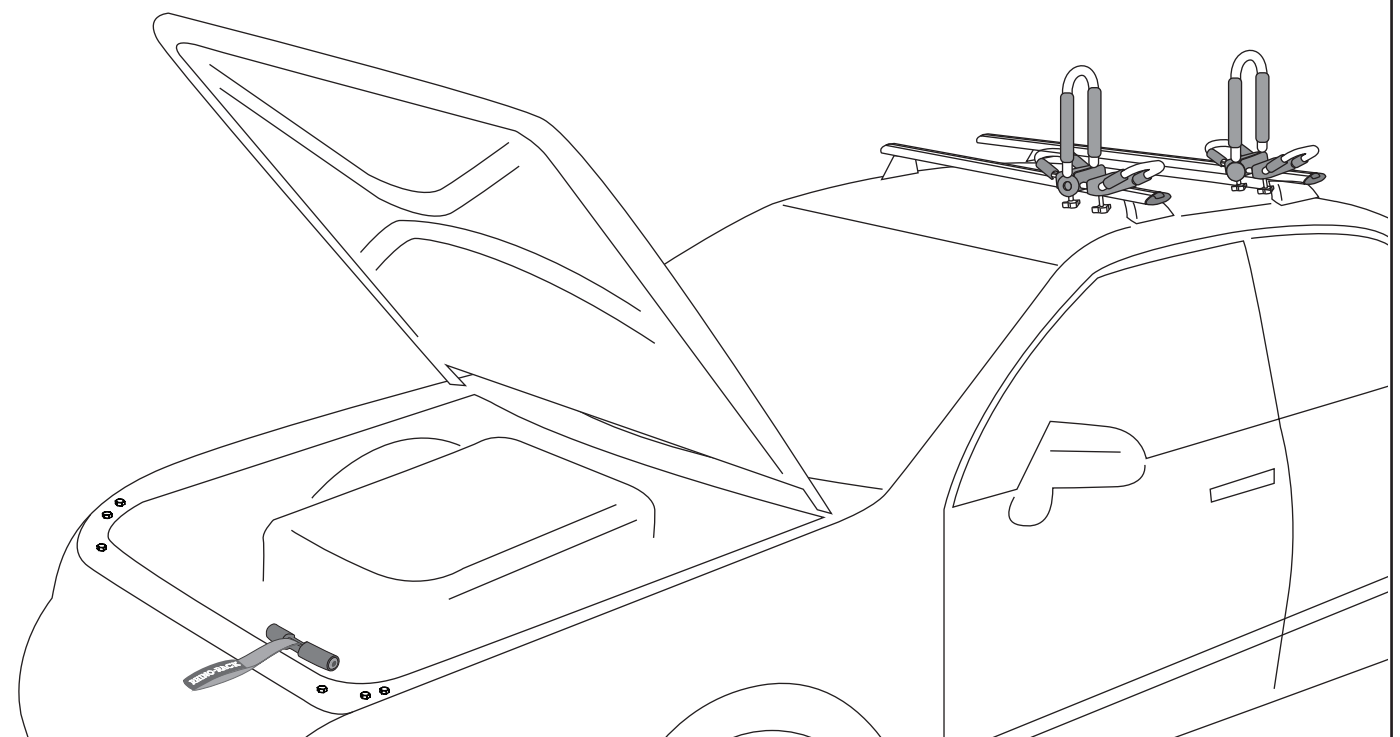



Rhino Bonnet/ Boot Anchor Straps (RBAS)

- 3** Close bonnet, ensure it's locked and check that the strap is held in place between the gap of the bonnet and the chassis of the car.

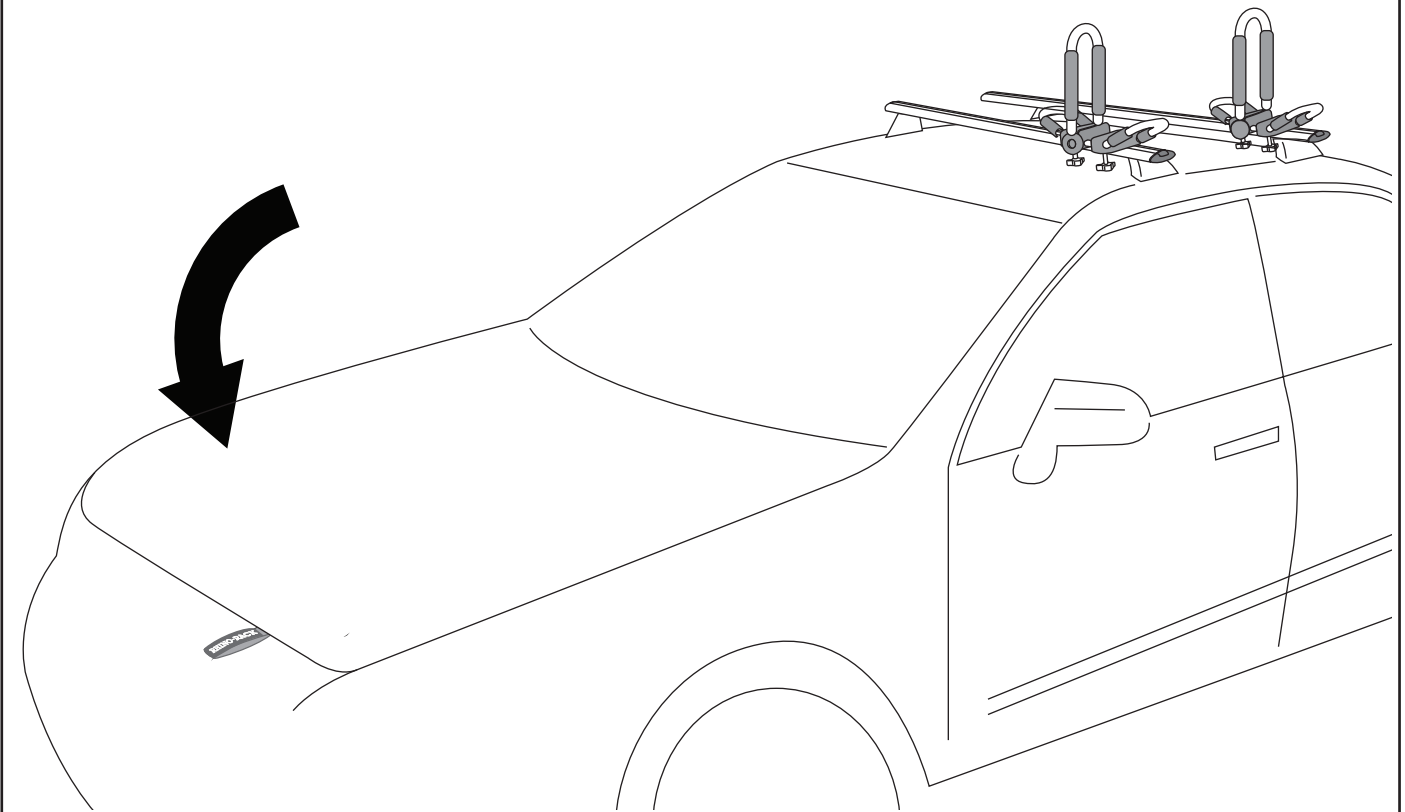

- 4** Tie your load to the anchor straps

Loop your tie down straps through the anchor straps as shown. Use of metal hooks is discouraged as they may damage your vehicle.

