

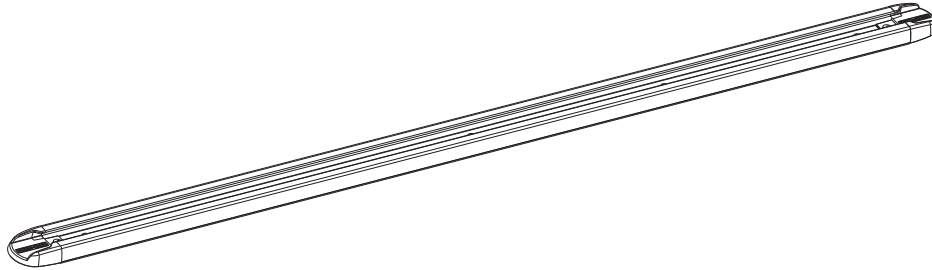

# RHINO-RACK

## RTV Track Kit

**Important:** Please refer to your fitting instruction to ensure that the roof racks are installed in the correct locations. Check the contents of kit before commencing fitment and report any discrepancies. Place these instructions in the vehicle's glove box after installation is complete.



### Download your Vehicle Fitment Sheet

Individual fitment sheets exist for most vehicles available, they provide specific fitment information that is relevant to each individual vehicle. Fitment sheets can be downloaded from the Rhino-Rack Website under 'Fit My Car'.

Simply select the make and model of the vehicle, select the Pioneer tray of choice and click on instructions.

**Be sure to check the website to see you have latest version of your instructions before attempting the fitment.**

### Important Information

1.  Check Part No./Kit is correct
2.  Read through instruction before installing
3.  Fit roof rack accessory
4.  Check and recheck all fasteners are secure

**Maximum carrying capacity for the track system is 100kg (220lbs).**

**Please refer to your vehicle manufacturers handbook for the maximum roof loading of your vehicle, also check Rhino-Rack website 'fit my car' section for the latest rating . Always use lower of the two figures. Note: Be sure to check the Rhino-Rack website to see if you have the latest version of instructions before beginning installation.**

#### Recommendations:

It is essential that all bolt connections be checked after driving a short distance when you first install your crossbars. Bolt connections should be checked & lubricated at regular intervals (probably once a week is enough, depending on road conditions, usage, loads and distances travelled). You should also check the crossbars each time they are refitted. Make sure to fasten your load securely. Please ensure that all loads are evenly distributed and that the centre of gravity is kept as low as possible.

**Crossbars must be removed when putting vehicle through an automatic car wash.**

**Use only non-stretch fastening ropes or straps.**

**Caution:** The handling characteristics of the vehicle changes when you transport a load on the roof. For safety reasons we recommend you exercise extreme care when transporting wind-resistant loads. Special consideration must be taken into account when cornering and braking.

#### Load Ratings:

Maximum permissible load is 100kg (220lbs) for two crossbars including the weight of the crossbars, 5kg (11lbs). When crossbars are to be used in off-road conditions, please build a safety factor of 1.5 into this load limit for off-road use, two crossbars = 66kg (145lbs). Although the crossbars are tested and approved to AS1235-2000, Off-road conditions can be much more rigorous. However, increasing the number of crossbars does not increase the vehicles maximum permissible roof loading.

#### Note for Dealers and Fitters:

It is your responsibility to ensure instructions are given to the end user or client.

Rhino-Rack

Fit Time: 45min

These instructions remain the property of Rhino-Rack Australia Pty. Ltd. and may not be used or changed for any other purpose than intended.



# RTV Track Kit

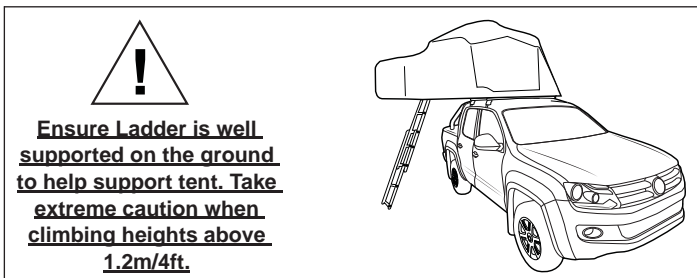
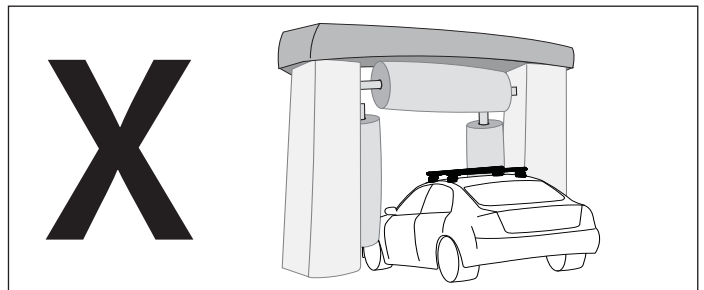
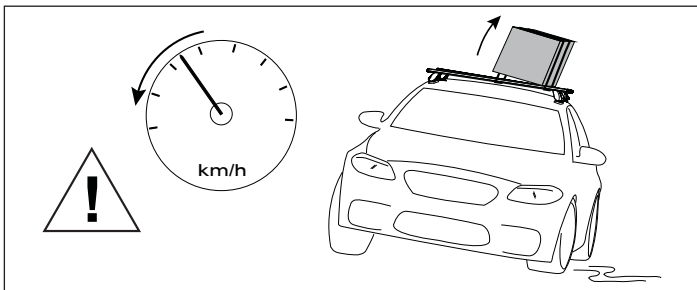
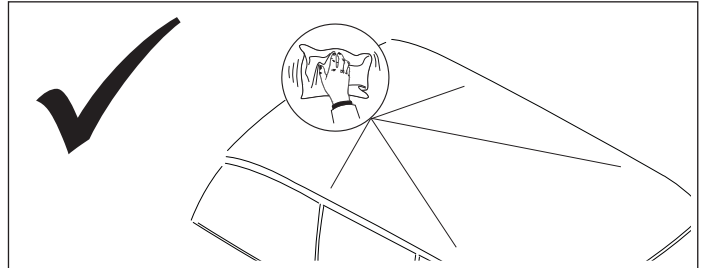
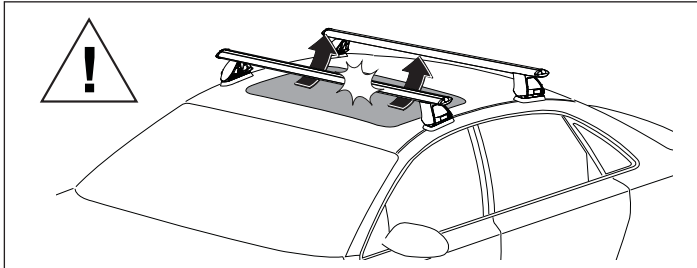
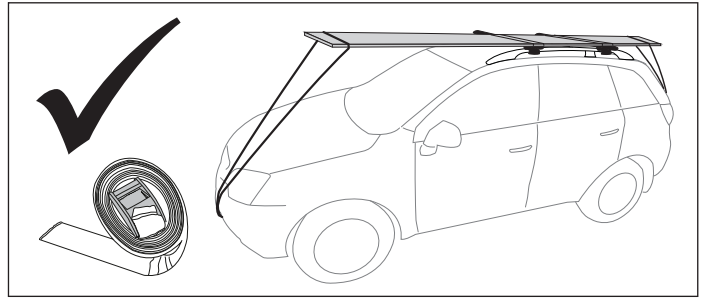
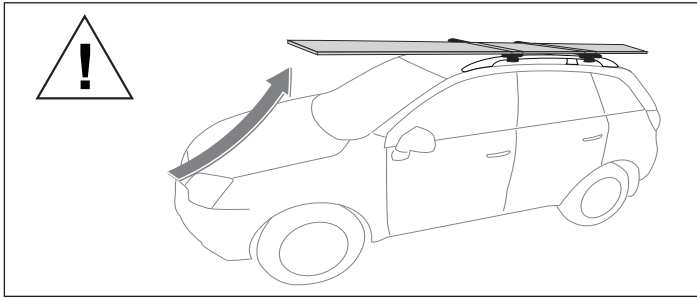

**Ensure Ladder is well supported on the ground to help support tent. Take extreme caution when climbing heights above 1.2m/4ft.**

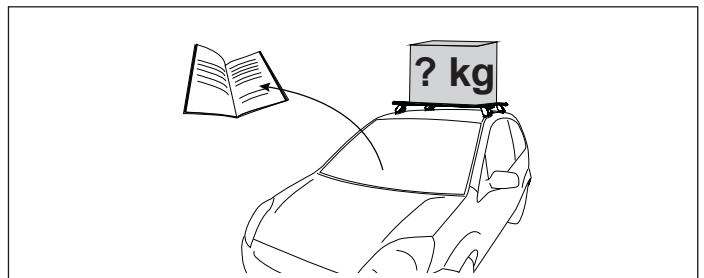

When these roof racks are to be used on a vehicle that is driven off sealed roads, the manufacturer maximum roof load rating (to be found in the vehicles User Manual) should be **divided by 1.5**. Do not forget to subtract the complete crossbar system weight from your maximum carrying capacity.

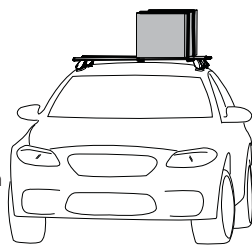

**100kg/220lbs**  
(Urban Road)

=

**67kg/147lbs**  
(Off Road)

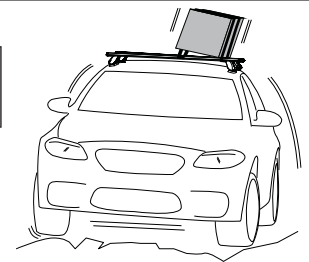

## WARNING! Important Load Carrying Instructions

With utility vehicles, the cabin and the canopy move independently. Roof racks and vehicle can be damaged if the item transported is rigidly fixed at points on both the cabin and canopy. Instead, rigidly fix to either the cabin roof racks or the canopy roof racks.

**X**  
NO

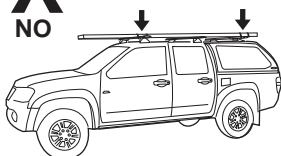

**✓**  
YES

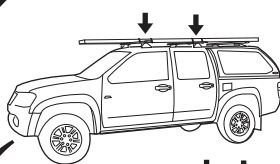

**✓**  
YES

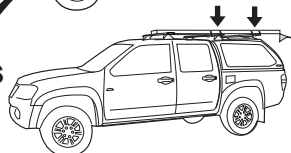

Paddle/ Surfboards should be fixed to the front of the vehicle.

**✓**  
YES

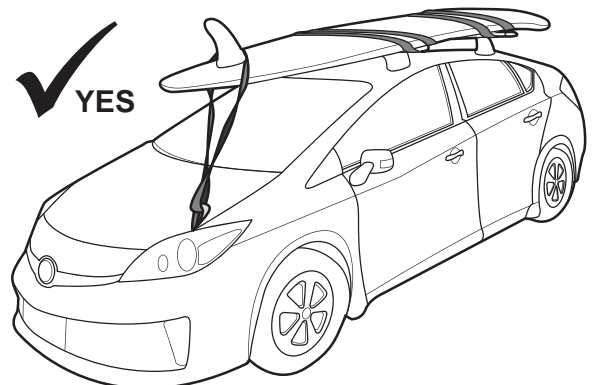



# RTV Track Kit

## Parts List

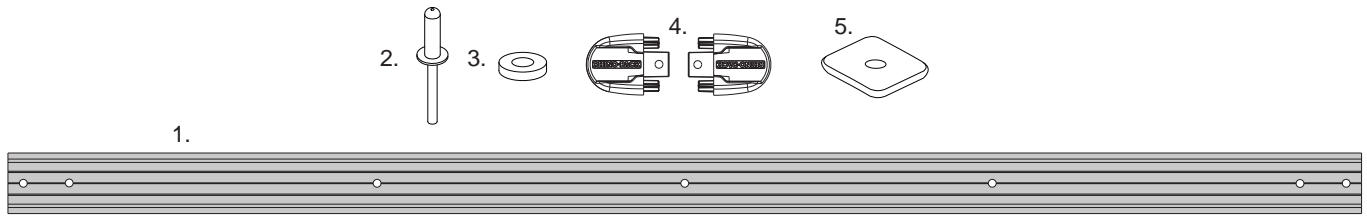

Item	RTV Kit	Qty	Part No.
1	RTV Track (various sizes, vehicle dependant)	2	A727-A736
2	Rivet	14-30	H004
3	Rivet Spacer	1	CA1555
4	End Cap	4	M768
5	Butyl Patch	14-30	CA1397
6	Instructions	1	R865

### Tools Required:

1. Measuring Tape
2. Drill
3. 5mm Drill Bit
4. Drill Stop
5. Masking Tape

6. Rivet Gun
7. Cold Galvanising Paint
8. Cotton Buds
9. Clean Cloth
10. Marker
11. Vacuum Cleaner

### Note:

**Crossbar and Leg Kits are sold as separate.** Leg Spacer kits may be required for more than two crossbars.

## Preparing Vehicle

- 1** Move to the roof of the vehicle. Use a clean cloth and remove any dirt and debris from the roof ditch in the approximate working area. **Apply masking tape in this area.**

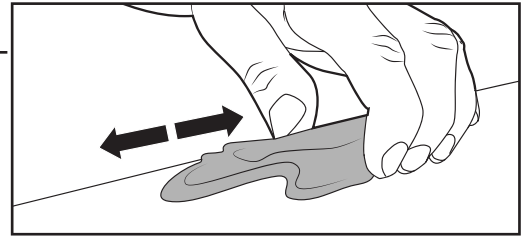
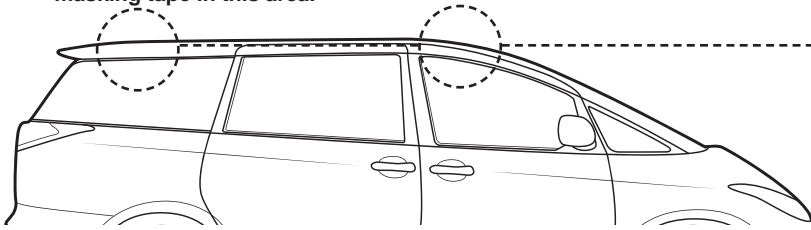

- 2** Tape up the approximate working area on the roof. Sit the Track Assembly onto the Tape (assistance may be required). The Tracks must be fitted as far apart as possible on the outer edge of the vehicle roof, adjust tape as required. The track must have full contact with the vehicle roof. Ensure the Assembly sits evenly spaced on the roof. Once location has been decided check on underside of roof for clearance. Check the Rhino-Rack website for any existing fitment positions.

Top View: **For reference only** - Actually points used to align the Track Assembly will vary from vehicle to vehicle.

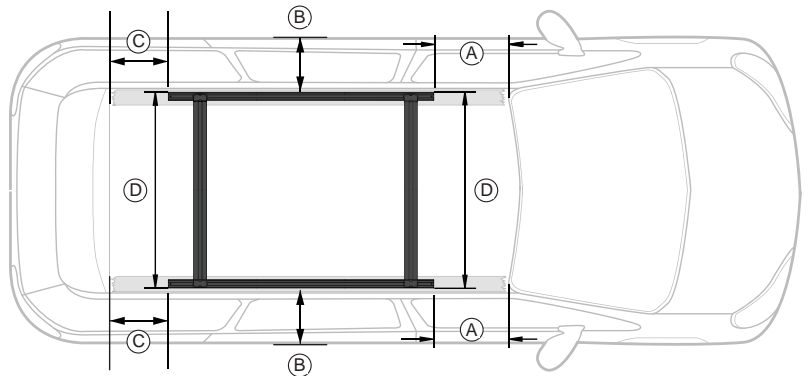

- 3** Use a Marker and create a reference point on the Masking Tape at all Rivet holes in the Track. Remove the Track and drill through the roof at these points as shown.

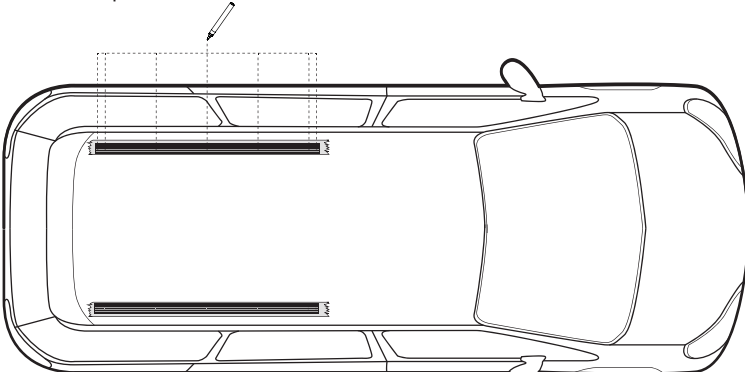

Use a 5mm Drill Bit, with a Drill Stop set to 5-7mm.

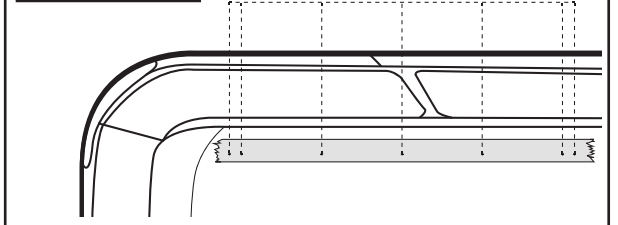



# RTV Track Kit

**4** Vacuum any swarf from the area.

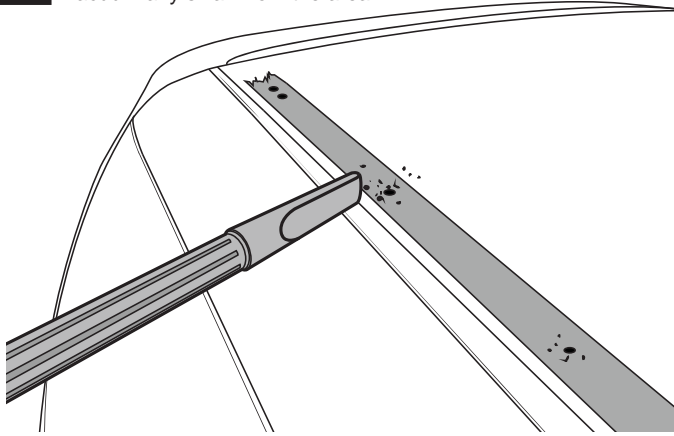

**5** Remove the Masking Tape. Using Cold Galvanising Paint, cover all drilled areas and any exposed body work.

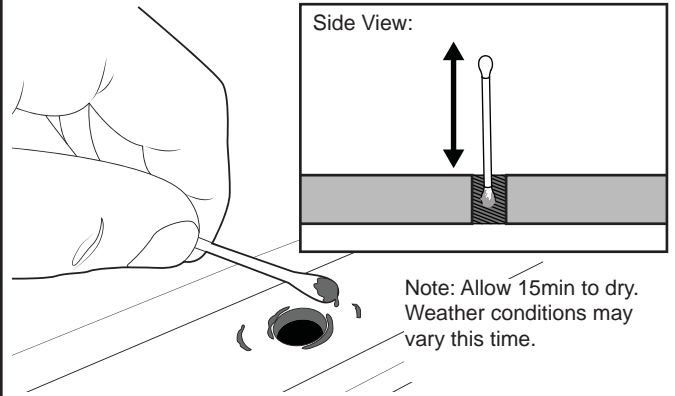

**6** Peel off the one side of backing tape on the Butyl Patches provided. Place these carefully over all holes drilled. Remove the top layer of backing tape as shown.

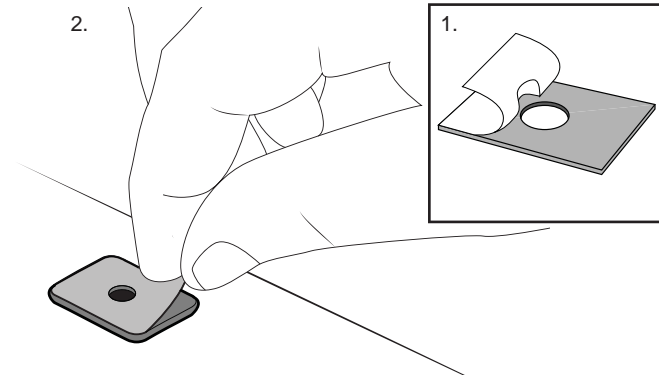

**7** Insert the End Caps and hold in place with Rivets. Place a Rivet in each of the holes along the Track.

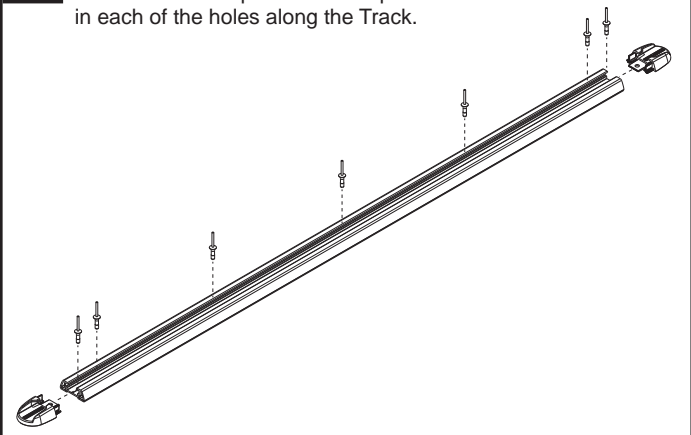

**8** Using either a Pneumatic or Concertina type Rivet Gun (not a small hand gun), rivet the Track into place. Make sure all Rivets are seated firmly onto the base of the Track, place the Rivet Gun onto the Rivet with a Rivet Spacer and gently tap on the back ensures the rivet is seated before compressing. **Check Track alignment carefully before starting. Start at the front and move towards the rear.**

**Note:** The Track will stand high at the rear when installing from the front. Minor force will be needed to flex the Track down while riveting.

Place the Rivet Gun Spacer over the Rivet before fixing in place. This will prevent the Rivet Gun scratching the Tracks.

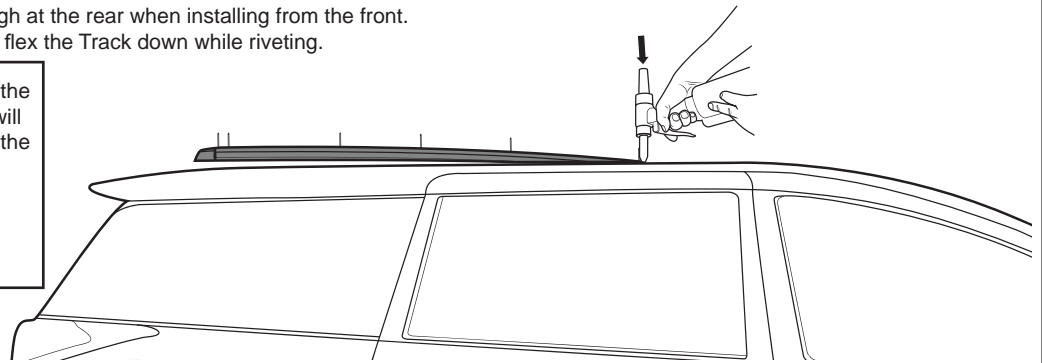
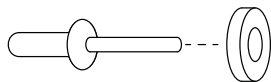

## Install Crossbars as per instructions

**Note** It is recommended to space crossbars 600mm-700mm apart.

