



# RHINO-RACK

## Volkswagen Amarok (RCP24-BK)

**Important:** Please read these instructions carefully prior to installation.  
Please refer to your fitting instruction to ensure that the roof racks are installed in the correct locations.  
Check the contents of kit before commencing fitment and report any discrepancies.  
Place these instructions in the vehicle's glove box after installation is complete.

### Layout

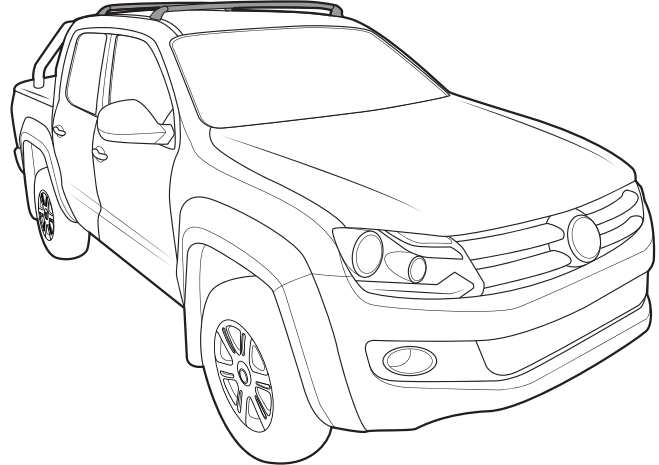
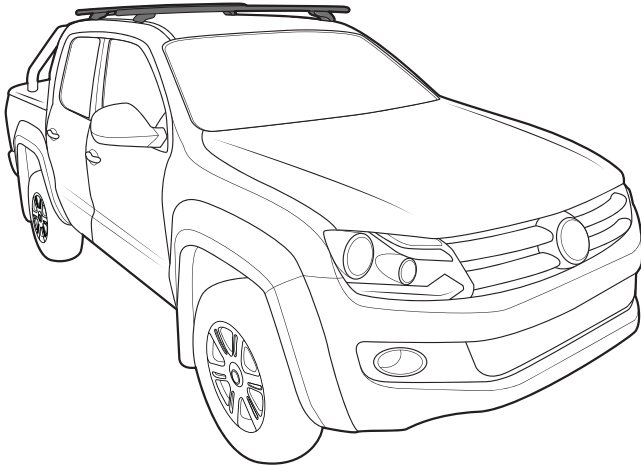

**Note:** Crossbars and legs sold as separate.

### Important Information

1.  Check Part No./Kit is correct
2.  Read through instruction before installing
3.  Fit roof rack accessory
4.  Check and recheck all fasteners are secure

**Note:** Be sure to check the Rhino-Rack website to see if you have the latest version of instructions before beginning installation.

**Maximum permissible load is 100kg (220lbs)** for two crossbars including the weight of the crossbars, 5kg (11lbs). When crossbars are to be used in off-road conditions, please build a safety factor of 1.5 into this load limit for off-road use, two crossbars = **66kg 145lbs**. Although the crossbars are tested and approved to AS1235-2000, off-road conditions can be much more rigorous. However, increasing the number of crossbars does not increase the vehicles maximum permissible roof loading.

**Refer to vehicle manufacturers handbook for maximum roof loading. Always use lower of the two figures.**

#### Recommendations:

It is essential that all bolt connections be checked after driving a short distance when you first install your crossbars. Bolt connections should be checked again at regular intervals (probably once a week is enough, depending on road conditions, usage, loads and distances travelled). You should also check the crossbars each time they are refitted. Make sure to fasten your load securely. Please ensure that all loads are evenly distributed and that the centre of gravity is kept as low as possible.

**Crossbars must be removed when putting vehicle through an automatic car wash.**

**Carrying Loads:** Use only non-stretch fastening ropes or straps to secure your load.

**Caution:** The handling characteristics of the vehicle change when you transport a load on the roof. For safety reasons we recommend you exercise extreme care when transporting wind-resistant loads. Special consideration must be taken into account when cornering and braking.



# Volkswagen Amarok (RCP24-BK)

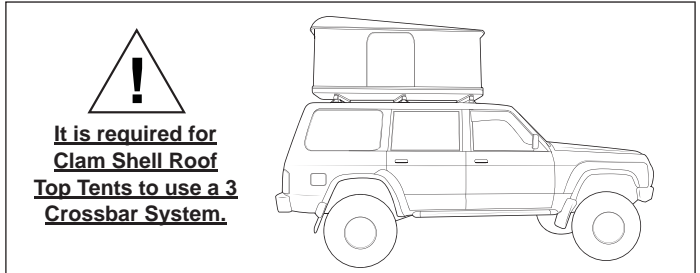
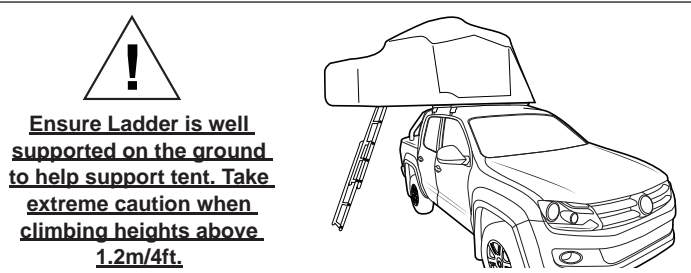
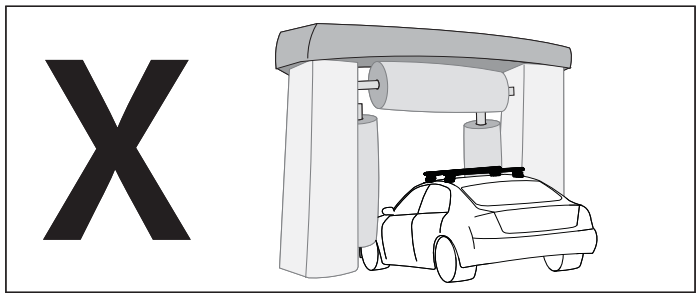
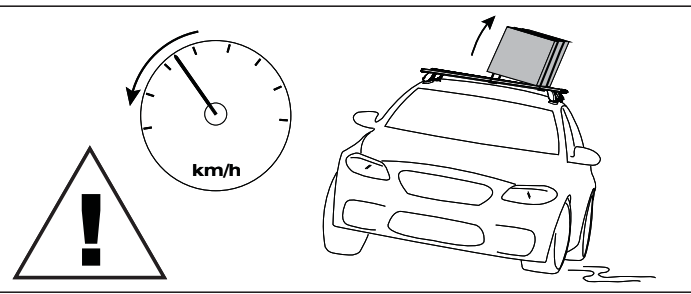
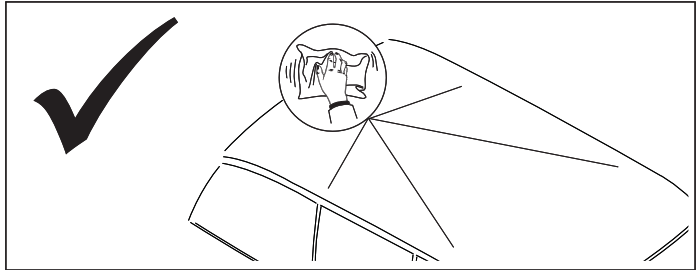
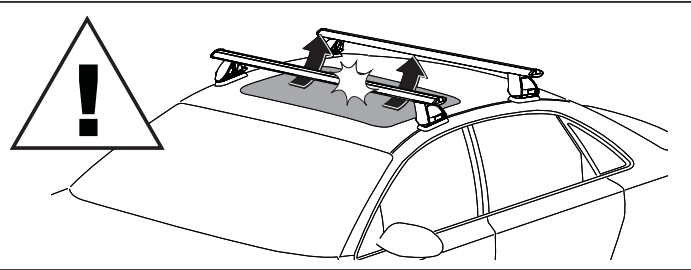
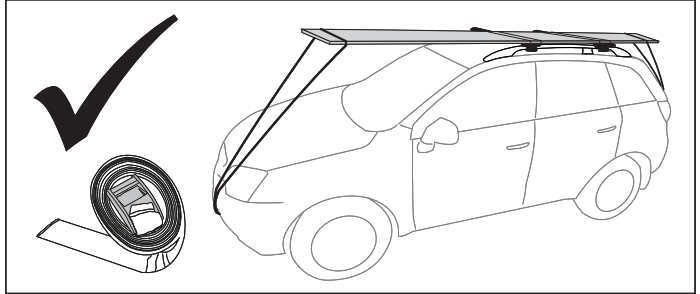
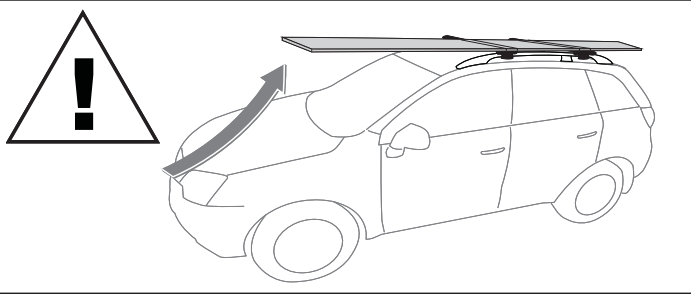

When these roof racks are to be used on a vehicle that is driven off sealed roads, the maximum roof rack load rating should be **divided by 1.5**. Do not forget to subtract 5kg from your maximum carrying capacity due to the weight of the crossbars and legs.

100kg/220lbs load rating (Urban road)	=	66kg/145lbs load rating (Off road - 100kg / 1.5)
---	---	---

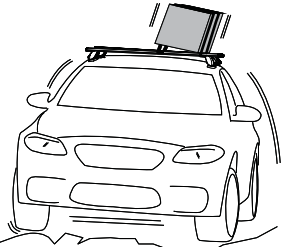
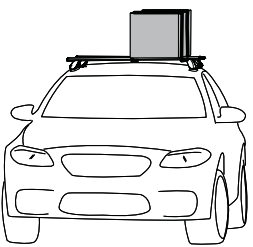

**WARNING! Important Load Carrying Instructions**

With utility vehicles, the cabin and the canopy move independently. Roof racks and vehicle can be damaged if the item transported is rigidly fixed at points on both the cabin and canopy. Instead, rigidly fix to either the cabin roof racks or the canopy roof racks.

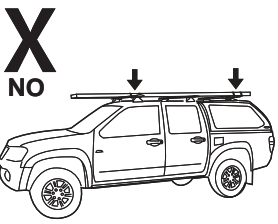
 **NO**

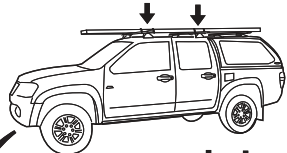
 **YES**

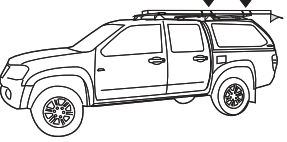
 **YES**

Paddle/ Surfboards should be fixed to the front of the vehicle.

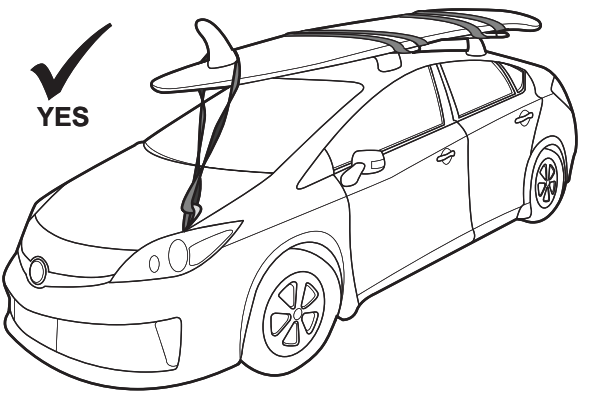
 **YES**



# Volkswagen Amarok (RCP24-BK)

## Parts List

Item	Component	F	R	2 Bar	Part No.
1	M6 x 30mm socket head cap screw	2	2	4	B047
2	M6 x 25mm Hex Setscrew	2	2	4	B001
3	3mm x 6mm O-ring	2	2	4	C347
4	Front Right pad FR	1	-	1	M546
5	Front Left pad FL	1	-	1	M547
6	Rear Right pad RR	-	1	1	M548
7	Rear Left pad RL	-	1	1	M549
8	Rubber skirt Left (short)	1	1	2	M550
9	Rubber skirt Right (short)	1	1	2	M551
10	Rubber skirt Left (long)	1	1	2	M552
11	Rubber skirt Right (long)	1	1	2	M553
12	5mm Allen Key	1	1	1	H021
13	M6 Spring washer	4	4	8	W004
14	M6 x 16mm flat washer	4	4	4	W031
15	Copper/foam washer	2	2	4	C967
16	Trim cover	2	2	4	M560
17	Pad Mount Covers	2	2	4	M126
18	M6 Washer (used on cover plate)	2	2	4	W003
19	Instructions	1	1	1	R1278

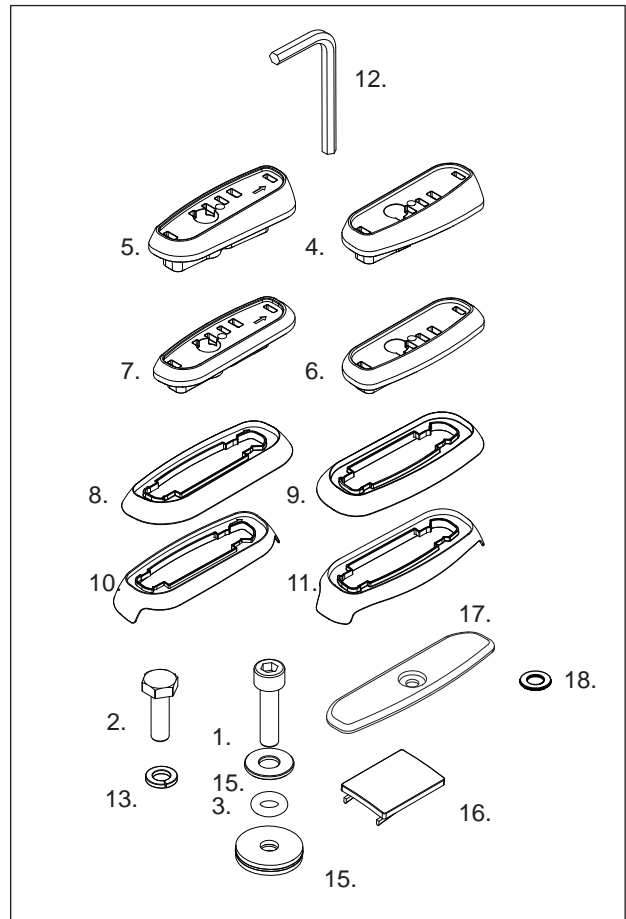

**Tools required:** Allen key, included. 10mm socket wrench.

## VW Amarok with Ditch Fill

For models with ditch fill, locate the 4x M6 Mounting Point Caps, these will be covered with a plastic covers. Use a flat head screwdriver and unscrew the covers to remove them. This will expose the Mounting Point Caps below.

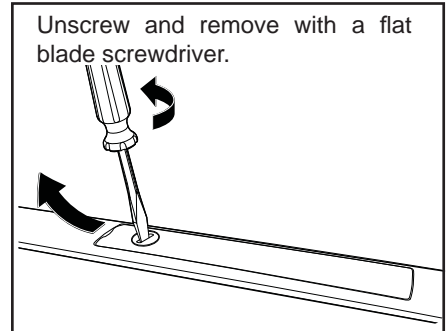
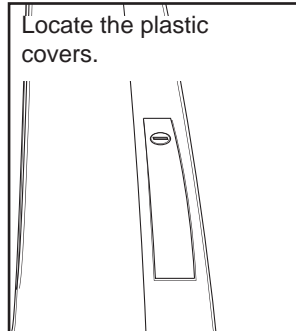
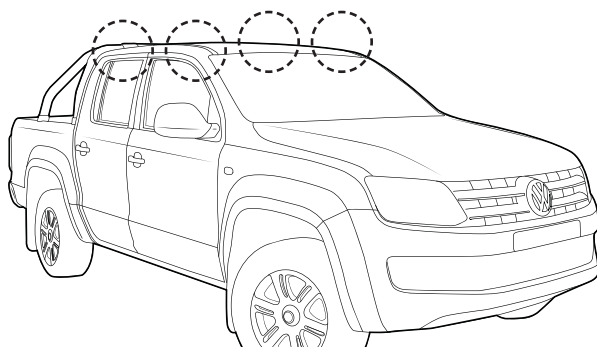

## VW Amarok with no Ditch Fill

Move to the roof of the vehicle. 1: If your car is not fitted with ditch trim, locate the 4x M6 Mounting Point Caps in the roof ditch. 2: Unscrew the 4x M6 Mounting Point Caps with a 5mm allen key. Clean roof ditch with a cloth.

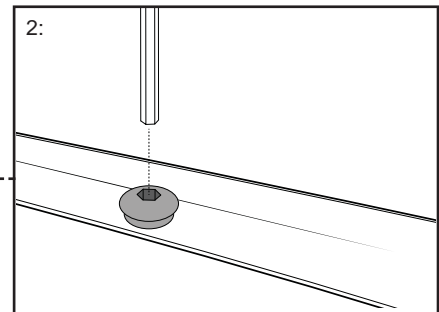
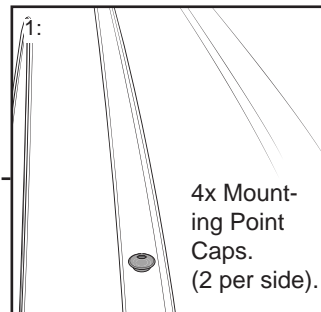
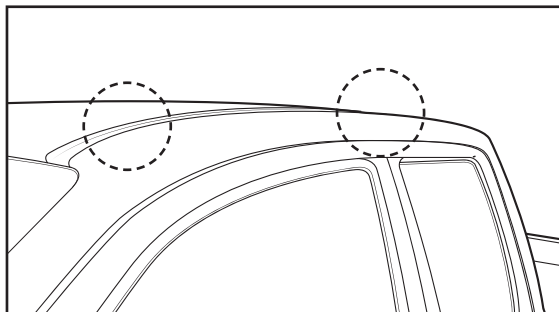



# Volkswagen Amarok (RCP24-BK)

**1a**

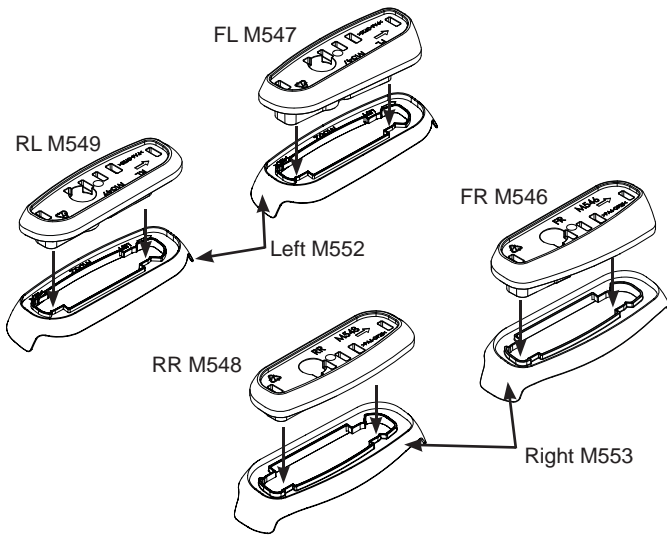

**Assembly for Models with no Ditch Trim:**

Front Left - FL M547  
Rear Left - RL M549  
Front Right - FR M546  
Rear Right - RR M548

Left skirt - Left M552  
Right skirt - Right M553

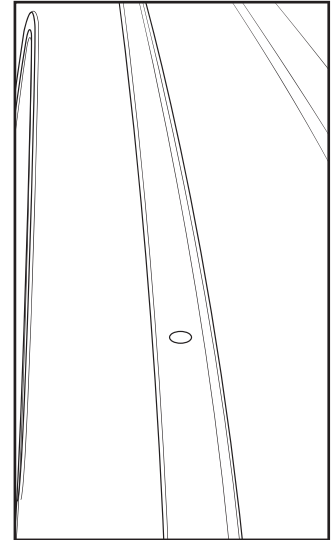

**1b**

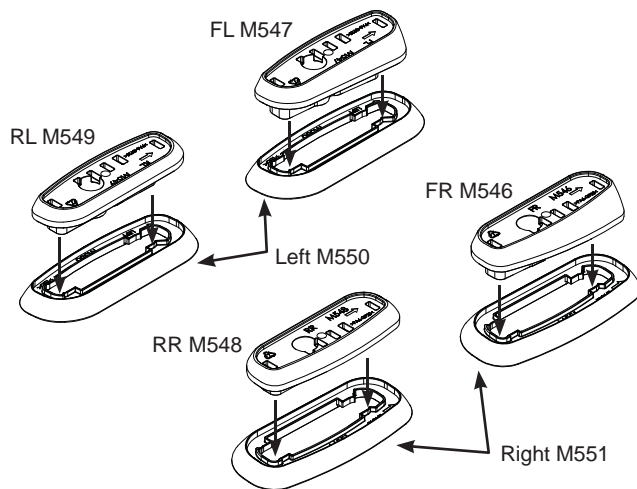

**Assembly for Models with Ditch Trim:**

Front Left - FL M547  
Rear Left - RL M549  
Front Right - FR M546  
Rear Right - RR M548

Left skirt - Left M550  
Right skirt - Right M551

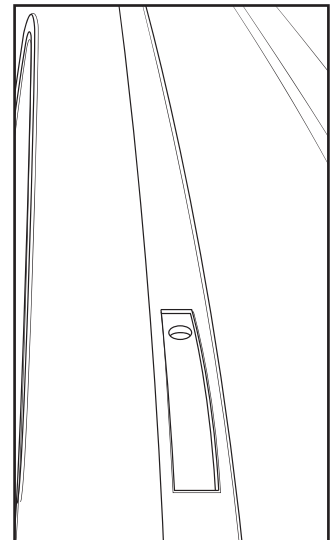

**2**

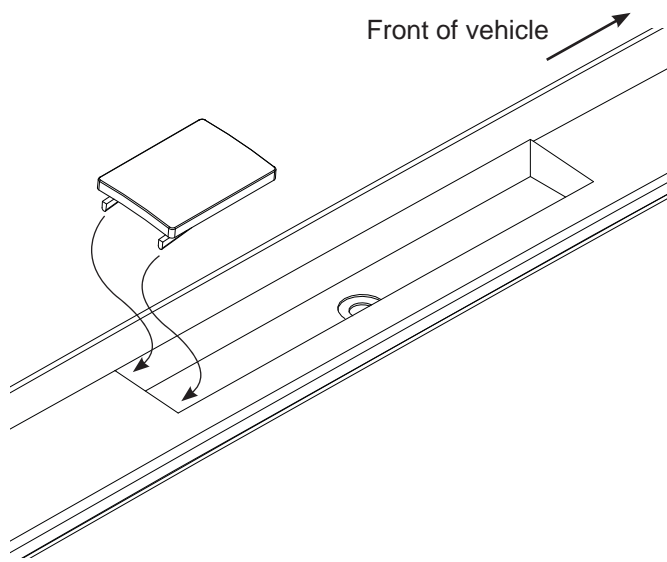

Fit Trim Covers, 4 places. **Only for vehicles with Ditch Trim.**



## Volkswagen Amarok (RCP24-BK)

3

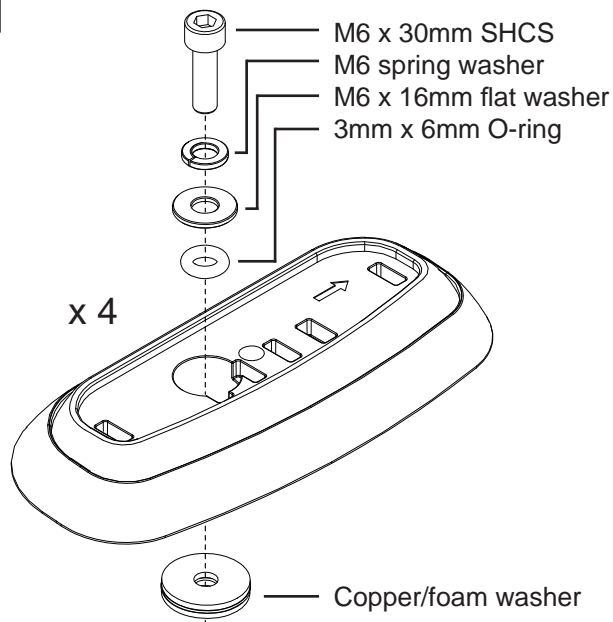

Install the hardware supplied into each Base assembly.  
Note: The Base Assemblies for vehicles with Ditch Fills are completed in the same fashion.

4



**Sit the Assemblies into place.**

Support rubber skirt when fitting to prevent it from folding under.

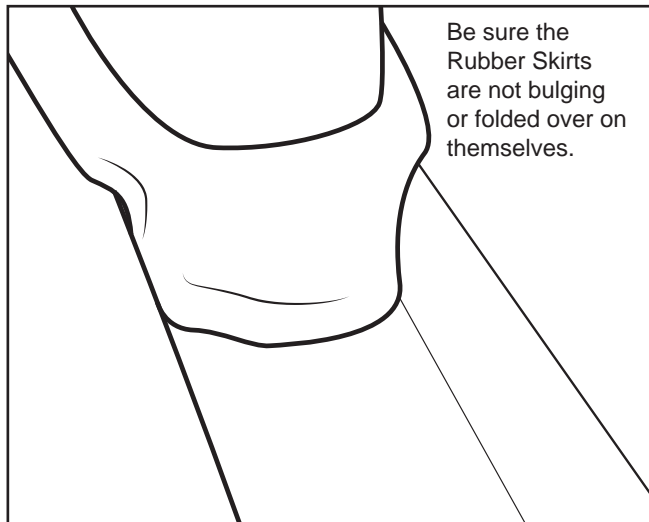
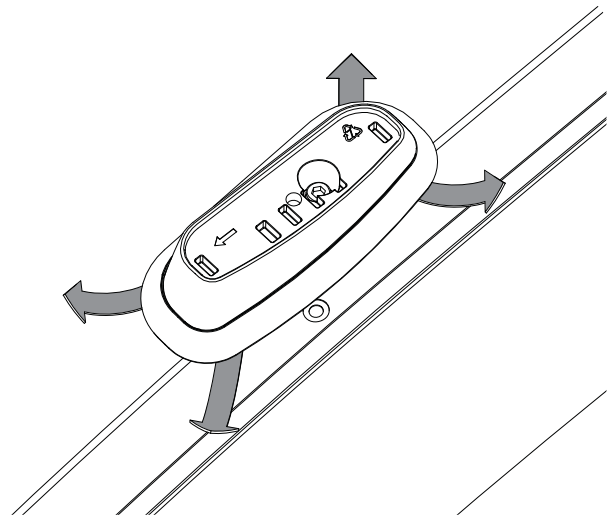
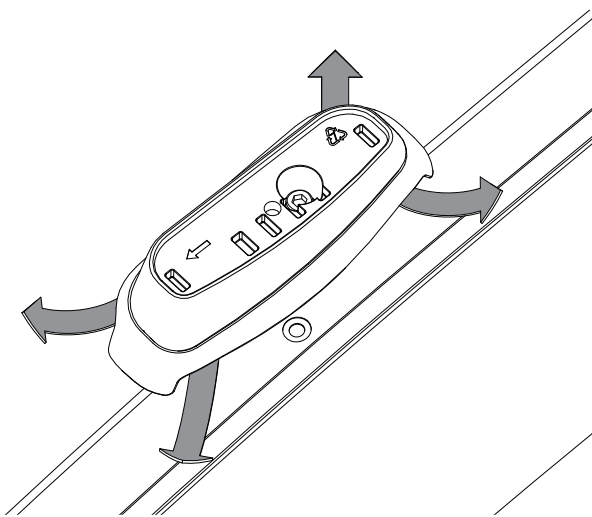

Be sure the Rubber Skirts are not bulging or folded over on themselves.

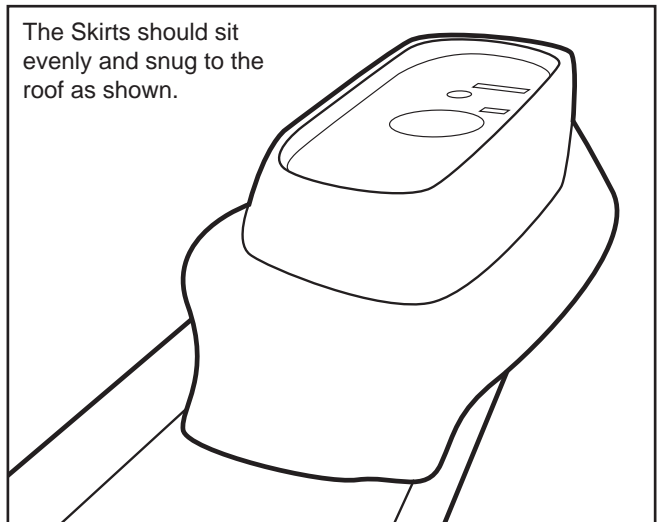

The Skirts should sit evenly and snug to the roof as shown.



## Volkswagen Amarok (RCP24-BK)

5

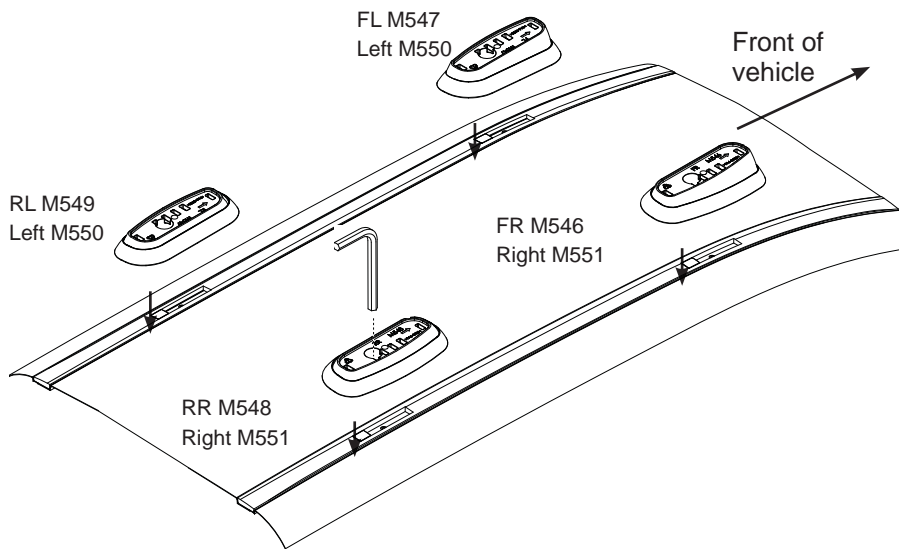

### Attach to Vehicles with Ditch Trim.

Fasten pads to roof.

Tighten M6 x 30mm screws, 5-6 Nm (3-4 lb/ft).

6

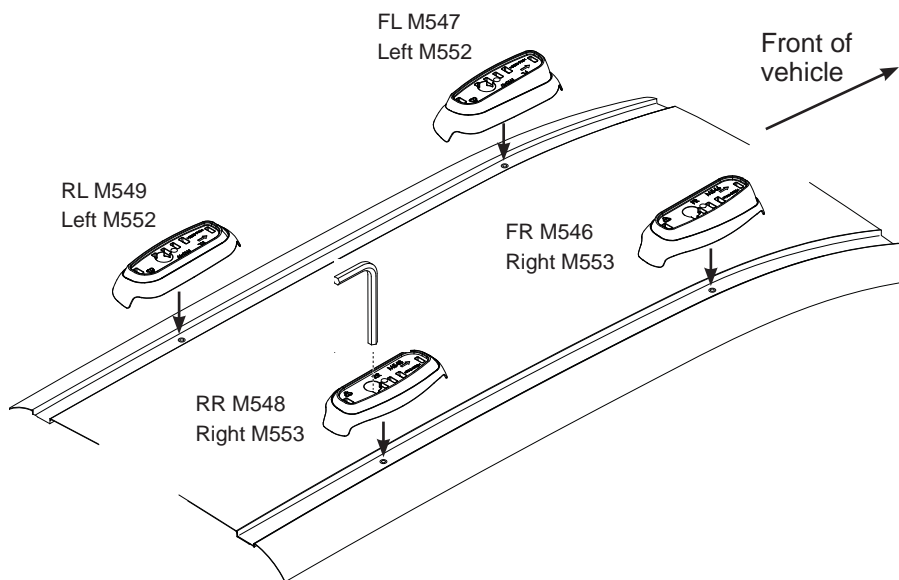

### Attach to Vehicles with no Ditch Trim.

Fasten pads to roof.

Tighten M6 x 30mm screws, 5-6 Nm (3-4 lb/ft).

7

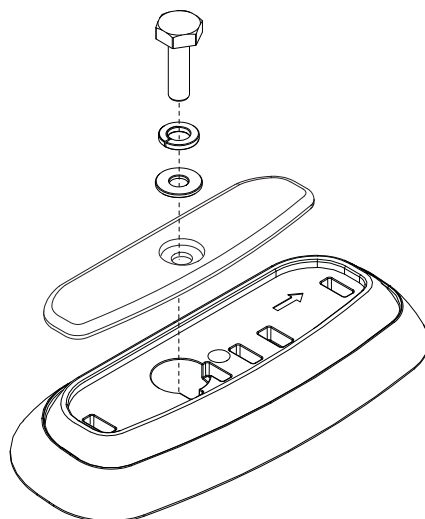

When crossbars are not in use, install the cover plates over the mounting points.