



RHINO-RACK

QMHD20

Item	Component Name	Qty	Part No.
1	M6 Channel Nut	2	N002
2	Quick Mount Leg HD Bar Spacer	2	M709
3	Quick Mount VA 15mm Spacer	2	M762
4	M6x45 Socket HD Cap Screw	2	B038
5	Instruction	1	R572

***Note:**

RLT600 Parts as separate.
Fix the Quick Mount Spacer to the Leg using the hardware in the leg kit. The bolts found in the spacer kit will replace the original in the leg kit.

Tools Required:

5mm Allen Key

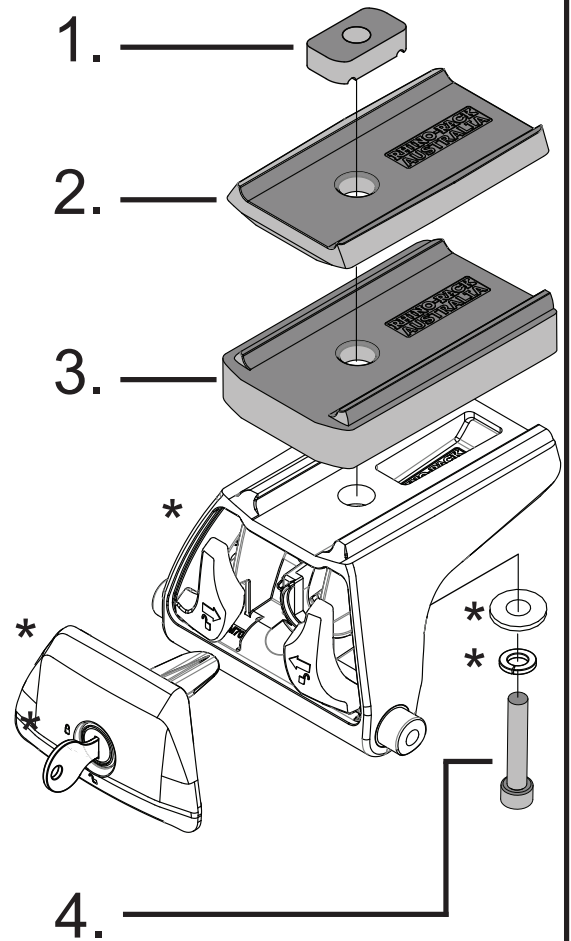

Note: Max Spacer height 30mm