

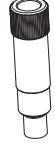







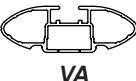

Maximum Carrying Capacity: Up to 75kg (165lbs) including the weight of the roof rack system evenly distributed over all crossbars.

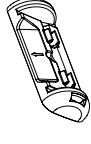
Instruction for

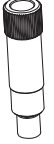
DK289 **RS350**
RS300 **RS351**
RS301 **RS367**
RS302 **RS403**
RS303 **RS404**
RS308 **RS559**
RS309 **RS680**
RS326

Vehicle	Date	Crossbar	FRONT						REAR							
			Front Pad	M6 Stud length (mm)	M6 Screw length (mm)	Measurement strip length per side	Measurement strip length per side	Measurement Distance (x)	Foot plate arrow direction	Rear Pad	M6 Stud length (mm)	M6 Screw length (mm)	Measurement strip length per side	Measurement strip length per side	Measurement Distance (x)	Foot plate arrow direction
			Crossbar Identification													
																
Hyundai Accent 5dr hatch	AU/NZ 7/11-	1180mm	M473	37	35	162mm	107mm	892mm / 35,1/8"	OUT	M473	37	35	163mm	108mm	894mm / 35,13/64"	OUT
	USA/CA 12-															
Hyundai i30 5dr hatch	10/07-04/12	1180mm	M473	37	35	163mm	108mm	894mm / 35,13/64"	OUT	M473	37	35	146mm	91mm	860mm / 33,55/64"	OUT
Hyundai i30 5dr hatch	05/12-	1180mm	M473	37	35	177mm	122mm	922mm / 36,19/64"	OUT	M473	37	35	162mm	107mm	892mm / 35,1/8"	OUT
Hyundai i30 3dr hatch	07/13-	1180mm	M473	37	35	177mm	122mm	922mm / 36,19/64"	OUT	M473	37	35	160mm	105mm	888mm / 34,31/32"	OUT
Hyundai Elantra GT 5dr hatch	13-	1180mm	M473	37	35	177mm	122mm	922mm / 36,19/64"	OUT	M473	37	35	162mm	107mm	892mm / 35,1/8"	OUT
Mitsubishi Outlander Sport SUV	11-	1260mm	M473	37	35	160mm	47mm	968mm / 38,7/64"	OUT	M473	37	35	133mm	20mm	914mm / 35,63/64"	OUT

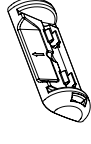
See Page 4 for additional fitting information on Mercedes CLK and Hyundai i30.

Vehicle	Date	Crossbar	FRONT						REAR							
			Front Pad	M6 Stud length (mm)	M6 Screw length (mm)	Crossbar Identification			Foot plate arrow direction	Rear Pad	M6 Stud length (mm)	M6 Screw length (mm)	Crossbar Identification			Foot plate arrow direction
						Measurement strip length per side	Measurement strip length per side	Measurement Distance (x)					Measurement strip length per side	Measurement strip length per side	Measurement Distance (x)	
Mitsubishi ASX 4dr SUV	10-	1260mm	M473	37	35	160mm	47mm	968mm / 38,7/64"	OUT	M473	37	35	133mm	20mm	914mm / 35,63/64"	OUT
Mitsubishi RVR 4dr SUV	11-	1260mm	M473	37	35	160mm	47mm	968mm / 38,7/64"	OUT	M473	37	35	133mm	20mm	914mm / 35,63/64"	OUT
Mitsubishi Lancer 4dr Sportback	10-	1180mm	M473	37	35	173mm	118mm	914mm / 35,63/64"	OUT	M473	37	35	156mm	101mm	880mm / 34,41/64"	OUT
Mazda 2 5dr hatch	11-	1065mm	M473	37	35	204mm	94mm	862mm / 33,15/16"	OUT	M473	37	35	165mm	55mm	784mm / 30,7/8"	OUT
Mazda 3 4dr sedan	AU/NZ 1/04-3/09	1180mm	M473	37	35	175mm	120mm	918mm / 36,9/64"	OUT	M473	37	35	165mm	110mm	898mm / 35,23/64"	OUT
	USA/CA 04-09															
Mazda 3 4dr sedan	AU/NZ 4/09-12/13	1180mm	M473	37	35	181mm	126mm	930mm / 36,39/64"	OUT	M473	37	35	168mm	113mm	904mm / 35,19/32"	OUT
	USA/CA 10-13															

Vehicle	Date	Crossbar	FRONT						REAR							
			Front Pad	M6 Stud length (mm)	M6 Screw length (mm)	Crossbar Identification			Foot plate arrow direction	Rear Pad	M6 Stud length (mm)	M6 Screw length (mm)	Crossbar Identification			Foot plate arrow direction
						Measurement strip length per side	Measurement strip length per side	Measurement Distance (x)					VA	EURO	HD	
Mazda 6 5dr hatch	08-12	1180mm	M473	37	35	166mm	111mm	900mm / 35,7/16"	OUT	M473	37	35	158mm	103mm	884mm / 34,51/64"	OUT
Mazda 6 4dr sedan	08-12	1180mm	M473	37	35	166mm	111mm	900mm / 35,7/16"	OUT	M473	37	35	158mm	103mm	884mm / 34,51/64"	OUT
Mazda CX-5 4dr SUV	12-16	1180mm	M473	37	35	191mm	136mm	950mm / 37,13/32"	OUT	M473	37	35	163mm	108mm	984mm / 35,13/64"	OUT
Mazda CX-7 4dr SUV	07-12	1260mm	M473	37	35	170mm	57mm	988mm / 38,57/64"	OUT	M473	37	35	154mm	41mm	956mm / 37,41/64"	OUT
Mazda CX-9 4dr SUV	07-15	1260mm	M473	37	35	188mm	75mm	1024mm / 40,5/16"	OUT	M473	37	35	175mm	62mm	998mm / 39,19/64"	OUT
Mercedes CLK/ CLK55 2dr coupe	97-02	1180mm	M473	37	35	137mm	82mm	842mm / 33,5/32"	OUT	M473	37	35	139mm	84mm	846mm / 33,5/16"	OUT
Peugeot 4008 4dr SUV	12-	1260mm	M473	37	35	160mm	47mm	968mm / 38,7/64"	OUT	M473	37	35	133mm	20mm	914mm / 35,63/64"	OUT



RHINO-RACK

DK289 VA, Euro, HD, RS Crossbar instruction

Hyundai i30 3 & 5dr and Hyundai Accent 5dr Hatch only.

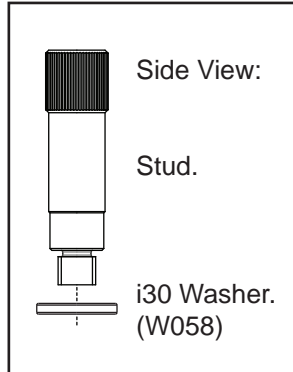

Place the four Washers provided under each of the Studs in the DK Kit. Install Studs as per instructions.

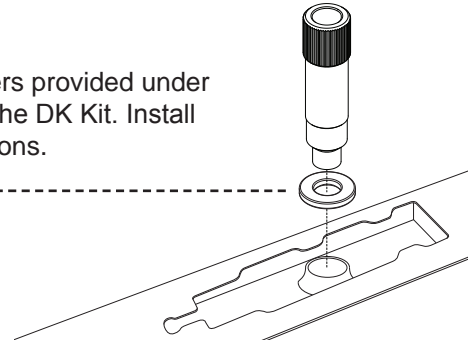

97-02 Mercedes CLK/ CLK55 only.

Fitting Instruction supplement R968 has specific information for attaching the roof rack to the Mercedes CLK.