

# Rhino-Rack 2500 Series - DK174/ DK174F instruction

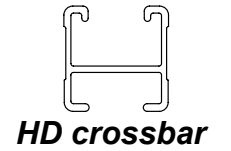

## IDENTIFICATION CHART

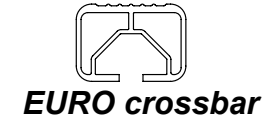
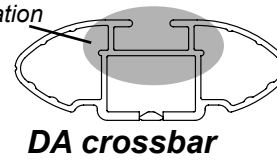
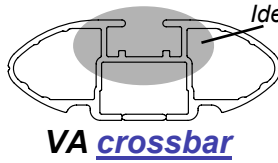

### FRONT CROSSBAR

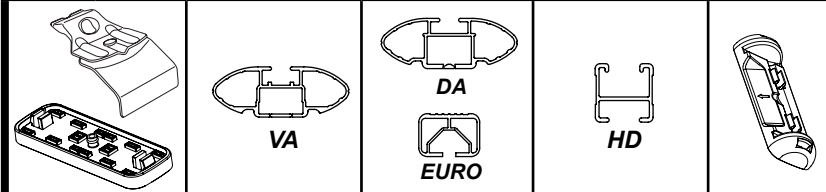

### REAR CROSSBAR

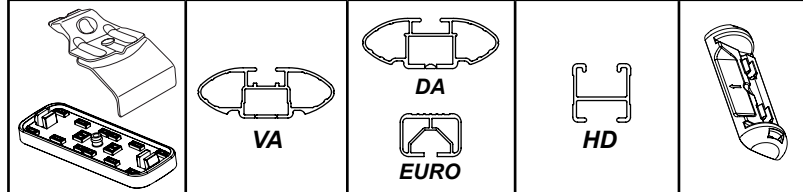

| Vehicle                                     | Date  | Crossbar | Front Pad/Clamp |         | Measurement strip length per side | Measurement strip length per side | Measurement Distance (x) | Foot plate arrow direction | Rear Pad/Clamp |         | Measurement strip length per side | Measurement strip length per side | Measurement Distance (x) | Foot plate arrow direction |
|---------------------------------------------|-------|----------|-----------------|---------|-----------------------------------|-----------------------------------|--------------------------|----------------------------|----------------|---------|-----------------------------------|-----------------------------------|--------------------------|----------------------------|
|                                             |       |          | Right           | Left    |                                   |                                   |                          |                            | Right          | Left    |                                   |                                   |                          |                            |
| Toyota Tacoma Double Cab                    | 05-   | 1375mm   | M366            | SUB0150 | 155mm                             | 100mm                             | 1073mm / 42,1/4"         | OUT                        | M366           | SUB0145 | 156mm                             | 101mm                             | 1075mm / 42,21/64"       | OUT                        |
|                                             |       |          | Pad Arrow       | FORWARD |                                   |                                   |                          |                            | Pad Arrow      | FORWARD |                                   |                                   |                          |                            |
| Volvo S60 4dr sedan                         | 01-09 | 1260mm   | M366            | SUB0145 | 182mm                             | 69mm                              | 1012mm / 39,27/32"       | OUT                        | M366           | SUB0150 | 193mm                             | 80mm                              | 1034mm / 40,45/64"       | OUT                        |
|                                             |       |          | Pad Arrow       | FORWARD |                                   |                                   |                          |                            | Pad Arrow      | FORWARD |                                   |                                   |                          |                            |
| Toyota Tacoma Double Cab (single front bar) | 05-   | 1375mm   | M366            | SUB0150 | 155mm                             | 100mm                             | 1073mm / 42,1/4"         | OUT                        | -              | -       | -                                 | -                                 | -                        | -                          |
|                                             |       |          | Pad Arrow       | FORWARD |                                   |                                   |                          |                            | -              | -       |                                   |                                   |                          |                            |



## Rhino-Rack 2500 Series - DK174/ DK174F instruction

**Measurement A:** CENTRE of door jamb to CENTRE arrow of leg foot plate.

**Measurement B:** CENTRE of Front leg foot plate arrow to CENTRE of Rear leg foot plate arrow.

**Carrying capacity:** Roof rack is rated to 75kg. Please refer to manufacturers handbook for your vehicles maximum roof load capacity. Always use the lower of the two figures.

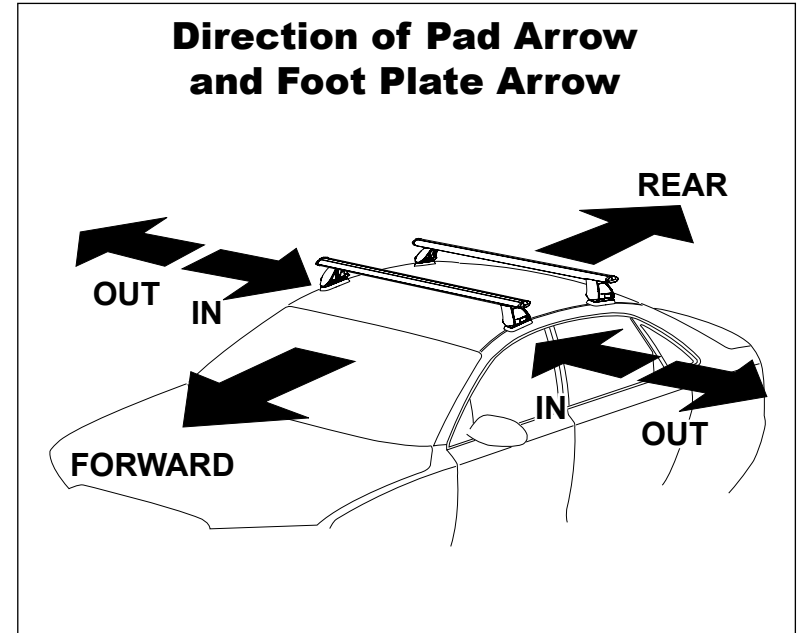
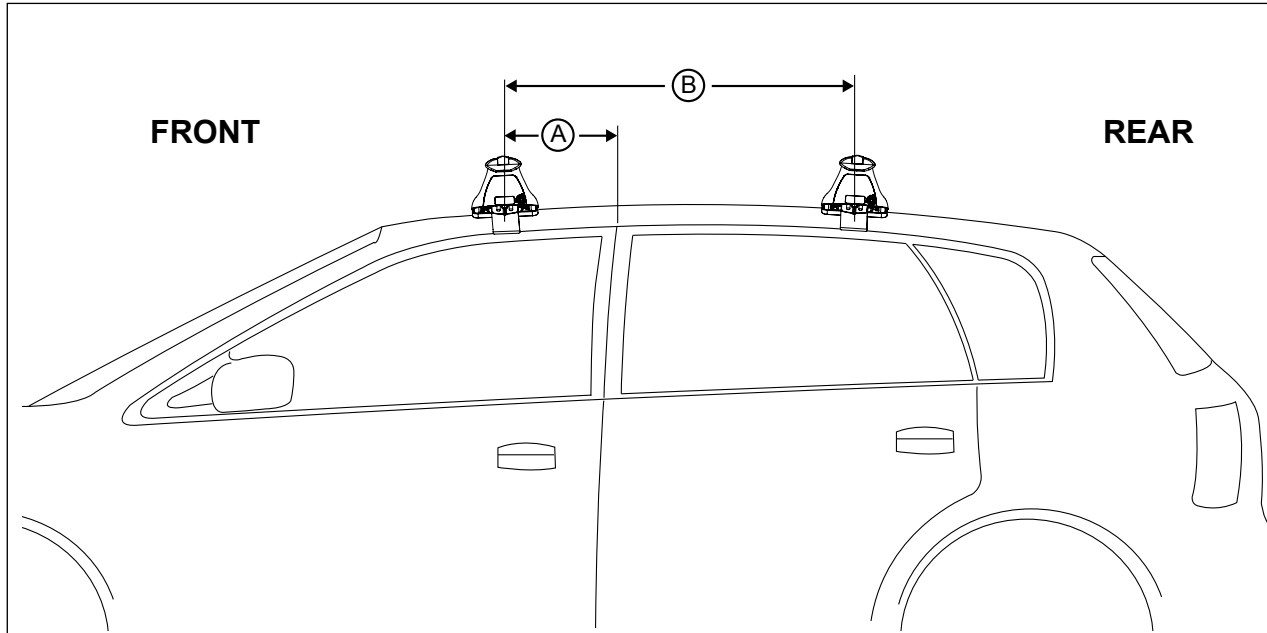

| Vehicle                                     | Date  | Measurement A    | Measurement B    | Load Rating<br>(includes racks 5kg/ 11lbs) |
|---------------------------------------------|-------|------------------|------------------|--------------------------------------------|
| Toyota Tacoma Double Cab                    | 05-   | 220mm/ 8,21/32"  | 800mm/ 31,1/2"   | 75kg/ 165lbs                               |
| Volvo S60 4dr sedan                         | 01-09 | 360mm/ 14,11/64" | 710mm/ 27,61/64" | 75kg/ 165lbs                               |
| Toyota Tacoma Double Cab (single front bar) | 05-   | 220mm/ 8,21/32"  | -                | 35kg/ 77lbs                                |