



RETRAC[®]

2019 CATALOG
APPLICATION GUIDES



**PAGE INTENTIONALLY LEFT
BLANK FOR TWO-PAGE VIEWING**



CURT is the leading manufacturer of USA-made trailer hitches and a complete line of towing and electrical products.



ARIES is a fast-paced marketer and innovator of truck, Jeep, SUV and CUV accessories.



UWS is a leading manufacturer and designer of USA-made truck tool boxes.



LUPERNE is a leading manufacturer of functional aftermarket accessories for pickup trucks, commercial vans and SUVs.



RETRAC is a leading manufacturer of OEM and aftermarket mirrors and front-end protection for heavy-duty and medium-duty trucks.

A leading sales, marketing, engineering and distribution company of towing products and truck accessories for all types of vehicles, from passenger cars to commercial trucks. We stand for EXCELLENCE in our products and our associates. We aspire to be the industry LEADER by recognizing that the customer is KING and our associates are our greatest ASSET.



We are a unified team of more than 1,000 dedicated associates world-wide.



We manufacture products in Wisconsin, South Dakota, Florida and Mexico.



We ship from 12 regional warehouses across the United States and Canada.

MileStone™
bumper guard



RETRAC®

**FRESH LOOK.
EVER RELIABLE.**

Since 1958, we have been renewing our commitment to providing quality products and great customer service. This year, we are renewing that commitment with an all-new logo.

Coinciding with other significant brand updates, such as website, collateral and display signage, this modern logo will help RETRAC continue its positive momentum as an industry leader. It was designed by our in-house creative team at CURT Group, in collaboration with several departments. Multiple revisions were created using feedback from Sales, Marketing, Product Development and more before the team landed on the finalized design. Beyond changing the shape of the logo, the most significant change is the new gold color. We decided on gold because it represents winning, quality and stands out in the industry.



INNOVATION IN EVERYTHING WE DO.

NEW PRODUCTS



**MILESTONE™
BUMPER GUARD**

08



**LED LIGHT BARS
& WORK LIGHTS**

11



20

**PROTEC EDGE™
GRILLE GUARD**



PRODUCT INDEX

Accessory mounting tabs	23	Mirror extensions	65
Adjustable stabilizers and braces	77	Mirror J-brackets	76
Aerodynamic convex mirror heads	52	Mirror loops	74
Aerodynamic west coast mirror heads	34	Motorized west coast mirror heads	39
Aerodynamic west coast replacement glass	36	Off-road west coast mirror heads	37
Angle-back west coast mirror heads	44	Offset-mount convex mirror heads	56
Auxiliary mirror mounting brackets	76	Pedestal-mount mirror assemblies	38
Bubble mirror heads	53	ProTec™ grille guards	18
Bubble-back west coast mirror heads	41	ProTec Edge™ grille guard	20
MileStone™ bumper guards	08	Pyramid-back west coast mirror heads	42
MileStone™ bumper guards, license plate bracket	10	Rear view mirror	67
MileStone™ bumper guards, light cage	10	Rear-mount safety mirror assemblies	61
Center-mount convex mirror heads	54	Rectangular convex mirror heads	58
Chevron west coast mirror heads	40	Rectangular convex utility mirror assembly	59
Convex step van mirror heads	71	Rib-back west coast mirror heads	41
Custom light-duty west coast mirror assemblies	64	Safety mirror assemblies	60
Custom step van mirror assembly sets	70	Standard grille guard mounting systems	22
Custom west coast mirror assemblies	46	Stick-on convex mirrors	58
Economy west coast mirror heads	39	Tuff Guard® grille guards	12
Grab handles	77	Tuff Guard® van grille guards	28
Grille guard mounting systems	22	Tuff Guard® van mounting brackets	29
Junior west coast mirror head	67	Tuff Guard XT™ grille guards	14
LED light bars	11	Tuff Guard II™ grille guards	16
LED work lights	11	Universal cabover mirror assembly	46
License plate bracket, MileStone™ bumper guards	10	Universal conventional mirror assembly	46
License plate bracket, grille guards	23	Universal light-duty mirror assemblies	65
Light-duty mirror heads	66	Universal light-duty mirror head with gooseneck	66
Look-down convex mirror assemblies	59	Universal step van mirror assembly set	70
MagLatch™ grille guard mounting systems	22	West coast conversion mounting kit	76
Mirror clamps	73	West coast step van mirror heads	71

TABLE OF CONTENTS

HEAVY-DUTY GRILLE GUARDS

MileStone™ bumper guards, LED lights, Tuff Guard®, Tuff Guard XT™, Tuff Guard II™, ProTec™, ProTec Edge™, accessories, mounting systems

06 - 31

HEAVY-DUTY MIRRORS

Aerodynamic, off-road, west coast, custom and universal assemblies

32 - 49

CONVEX & SAFETY MIRRORS

Aerodynamic, bubble, center and offset-mount, rectangular, stick-on, safety assemblies

50 - 61

LIGHT-DUTY MIRRORS

Custom and universal assemblies, mirror heads, junior west coast, rear view

62 - 67

STEP VAN MIRRORS

Custom and universal assembly sets, mirror heads

68 - 71

COMPONENT PARTS

Clamps, loops, J-brackets, stabilizers, braces, grab handles

72 - 77

MARKETING MATERIALS

Literature, catalog, banners, retail signage, display stands

78 - 80



HEAVY-DUTY GRILLE GUARDS

PROFESSIONAL STYLE & PROTECTION

For your customers, an investment in front-end protection is an investment in their livelihood. Whatever they may be hauling, RETRAC heavy-duty grille guards offer reliable front-end protection for their heavy-duty truck. New for 2019, we have added two exciting new grille guard options. Our MileStone™ bumper guard has a patented LED light bar cage integrated with the frame. Our new ProTec Edge™ grille guard features a unique, contoured design to better accent modern trucks.

FEATURED PRODUCTS



MileStone™ bumper guard

With a low profile and optional integrated light cage, this new guard offers enhanced road safety without obstructing the fold-down hood.



ProTec Edge™ grille guard

This new guard contours to the body lines of modern trucks and offers superior protection for the grille, bumper, fenders and lights.



MagLatch™ brackets

MagLatch™ brackets feature rare-earth magnets and fold down as needed for convenient hood access. Standard latch also available.

PRODUCT INDEX



08
MileStone™
Bumper Guards



10
MileStone™
Light Cages



11
LED Light Bars
& Work Lights



12
Tuff Guard®
Grille Guards



14
Tuff Guard XT™
Grille Guards



16
Tuff Guard II™
Grille Guards



18
ProTec™
Grille Guards



20
ProTec Edge™
Grille Guards



22
Grille Guard
Brackets



23
Grille Guard
Accessories



28
Tuff Guard® Van
Grille Guards

MILESTONE™ BUMPER GUARDS

NEW

KEY FEATURES

Sleek, subtle design contours to the truck bumper for a streamlined fit

Available with or without patented light cage and 30" LED light bar

Product Details

- Integrated light bar for enhanced visibility and safety on the road
- Patented light cage keeps the light bar protected from theft and the elements
- Channel mount allows light bar to be adjusted and aligned unlike welded tabs
- Low profile for full under-the-hood access without needing to fold down the guard
- 3" diameter, 14-gauge stainless steel tubing for solid front-end protection
- 6mm upright plates provide enhanced strength and a highly secure mount
- Heavy-duty extruded rubber facings shield uprights against scuffs and scratches
- Easy installation with no drilling or front-end modification required
- Limited lifetime warranty (see last page for details)
- Patent# US9108581B2
- **See adjacent page for application information**



207800



208805

Finishes & Materials



Finish:
Polished
stainless

Material:
Stainless
steel



Finish:
Smooth
black

Material:
Stainless
steel



MILESTONE™ BUMPER GUARDS APPLICATION GUIDE

MileStone™ Bumper Guards								
Make / Model	Years	Kit (Guard, Brackets, Light Cage and Light Bar)		Guard & Brackets		Light Cage Only		Light Bar Only
		Polished#	Black#	Polished#	Black#	Polished#	Black#	Light Bar#
Freightliner								
New Cascadia	18 - 19	208805†	208800†	207805	207800	207715†	207710†	391264*
M2 / B2 106	09 - 19	208775†	208770†	207775	207770	207715†	207710†	391264*
Hino								
258 / 268 / 338	10 - 18	208785†	208780†	207785	207780	207715†	207710†	391264*
International								
ProStar / LT	08 - 18	208755†	208750†	207755	207750	207715†	207710†	391264*
Volvo								
VNL	04 - 19	208705†	208700†	207705	207700	207715†	207710†	391264*

* LED light may require additional wire for proper installation

† Light cage is not compatible with VORAD systems



MILESTONE™ BUMPER GUARD LIGHT CAGES

NEW

- Compatible with all MileStone™ bumper guards
- Channel-style bracket accepts one or multiple light bars up to 30" in total length (see adjacent page for LED lights)
- Helps protect light bar from theft and the elements
- Non-corrosive stainless steel construction in two finish options
- Includes mounting hardware for bolting onto the guard



207715



207710

Part#	Inside Width	Inside Height	Inside Depth	Finish
207715 NEW	34-3/8"	4-1/4"	2" (open back)	Polished
207710 NEW	34-3/8"	4-1/4"	2" (open back)	Smooth black

MILESTONE™ BUMPER GUARD LICENSE PLATE BRACKET

NEW

- Easily bolts onto the crossbar, using included hardware
- Provides a solid mounting location to keep license plate visible
- Strong steel construction with a durable black powder coat finish
- Includes license plate mounting bolts



207735



Part#	Includes	Finish
207735 NEW	Bracket and mounting hardware	Steel with black powder coat



LED LIGHT BARS & WORK LIGHTS

NEW

- Constructed with grade-A, Cree LED chips for superior quality
- IP68 and IP69K waterproof and dustproof ratings to keep water and air from getting trapped inside
- Rust-free aluminum housing with rugged, crack-resistant Lexan lens
- Durable, painted, UV-resistant and mar-resistant finish
- Advanced optics system reduces wasted light for 96% reflector efficiency
- Dual, oversize heat sinks maintain low, efficient running temperatures
- Instant on-off requires no warmup time
- 50,000+ hours average lifespan for five years of continuous use
- Passes CE, RoHS, UV, extreme temperature, vibration, dust and salt testing
- Operates in temperatures from -40°F up to 145°F for extreme conditions
- Fitted with a strong, waterproof wiring harness for a reliable connection
- Includes stainless steel screws and a pivoting bracket for custom angling
- Limited lifetime warranty (see last page for details)



391252



391262



391264

Part#	Light Type	Configuration	Light Size	Beam	Lumens
391252 NEW	Work light	Square (set of two)	2"	Spot	2,200
391262 NEW	Light bar	Single-row	20"	Combo	9,800
391264 NEW	Light bar	Single-row	30"	Combo	14,800

TUFF GUARD® GRILLE GUARDS

KEY FEATURES

3" diameter, 14-gauge stainless steel tubing for added vehicle protection

Compatible with VORAD systems and fog lights

Product Details

- Compatible with standard latch or MagLatch™ brackets (both sold separately, see page 22)
- Versatile design fits multiple heavy-duty trucks (brackets vehicle-specific)
- Folds down for convenient access under the hood
- Easy installation with no drilling or front-end modification required
- Limited lifetime warranty (see last page for details)
- [See page 24 for application information](#)



Finishes & Materials



Finish:
Textured
black

Material:
Stainless
steel



Finish:
Polished
stainless

Material:
Stainless
steel



TUFF GUARD XT™ GRILLE GUARDS

NEW

KEY FEATURES

- 3" diameter, 14-gauge stainless steel tubing for added vehicle protection
- Taller frame allows compatibility with VORAD systems and fog lights on select applications

Product Details

- Compatible with standard latch or MagLatch™ brackets (both sold separately, see page 22)
- Versatile design fits multiple heavy-duty trucks (brackets vehicle-specific)
- Folds down for convenient access under the hood
- Easy installation with no drilling or front-end modification required
- Limited lifetime warranty (see last page for details)
- **See page 24 for application information**

Finishes & Materials



Finish:
Textured
black

Material:
Stainless
steel



Finish:
Polished
stainless

Material:
Stainless
steel

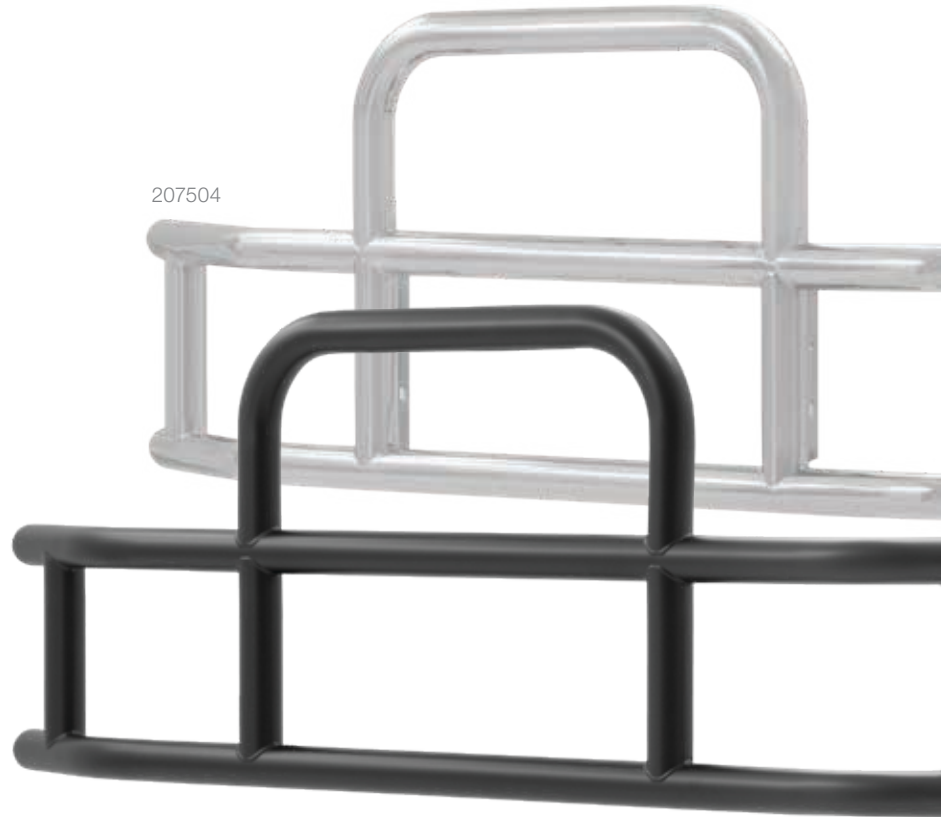

207504

207505



TUFF GUARD II™ GRILLE GUARDS

KEY FEATURES

3" diameter, 14-gauge stainless steel tubing for added vehicle protection

Welded, overlapping tube layout for enhanced strength

Product Details

- Compatible with VORAD systems and fog lights
- Compatible with standard latch or MagLatch™ brackets (both sold separately, see page 22)
- Versatile design fits multiple heavy-duty trucks (brackets vehicle-specific)
- Folds down for convenient access under the hood
- Easy installation with no drilling or front-end modification required
- Limited lifetime warranty (see last page for details)
- **See page 24 for application information**

Finishes & Materials



Finish:
Textured
black

Material:
Stainless
steel



Finish:
Polished
stainless

Material:
Stainless
steel

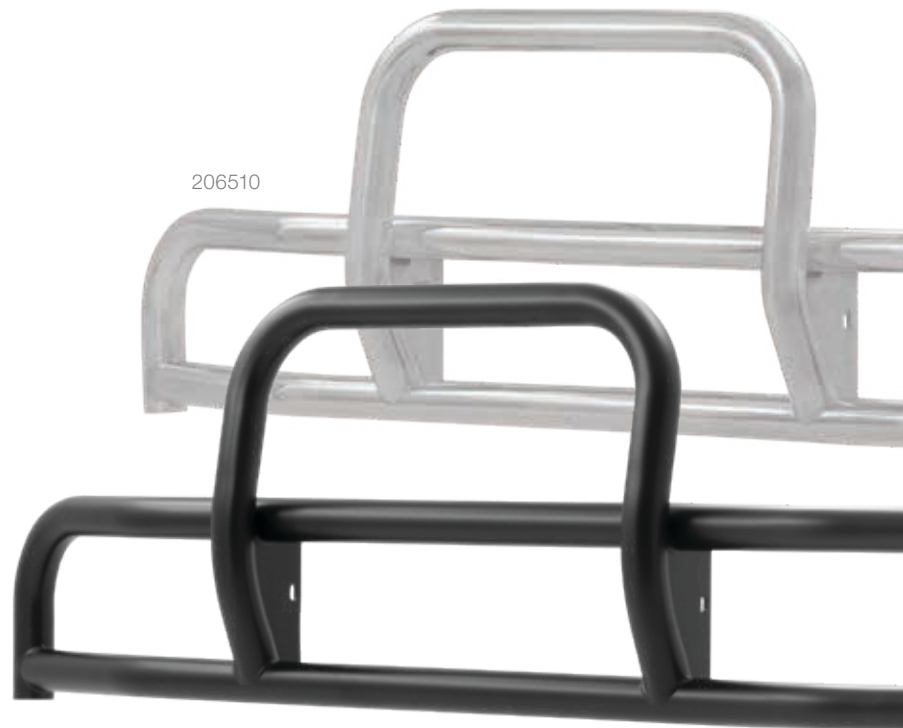

206510

206511



PROTEC™ GRILLE GUARDS

KEY FEATURES

3" diameter, 14-gauge stainless steel tubing for added vehicle protection (11-gauge for carbon steel)

Welded, double-stacked layout protects bumper, grille and lights

Product Details

- Compatible with VORAD systems and fog lights
- Compatible with standard latch or MagLatch™ brackets (both sold separately, see page 22)
- Versatile design fits multiple heavy-duty trucks (brackets vehicle-specific)
- Folds down for convenient access under the hood
- Easy installation with no drilling or front-end modification required
- Limited lifetime warranty (see last page for details)
- **See page 24 for application information**

Finishes & Materials



Finish:
E-coat and smooth black

Material:
Carbon steel



Finish:
Polished stainless

Material:
Stainless steel



205515

205518



PROTEC EDGE™ GRILLE GUARDS

NEW

KEY FEATURES

2-1/2" diameter, 14-gauge steel tubing for solid front-end strength

Contoured design follows body lines of modern aerodynamic trucks

Product Details

- Multiple crossbars and curved sides provide superior protection
- Textured, bedliner-type finish with E-coat for exceptional corrosion resistance
- Compatible with standard latch or MagLatch™ brackets (both sold separately, see page 22)
- Versatile design fits multiple heavy-duty trucks (brackets vehicle-specific)
- Compatible with VORAD systems and fog lights (most applications)
- Folds down for convenient access under the hood
- Easy installation with no drilling or front-end modification required
- Limited lifetime warranty (see last page for details)
- **See page 24 for application information**
- **Additional applications for this exciting new product coming soon**

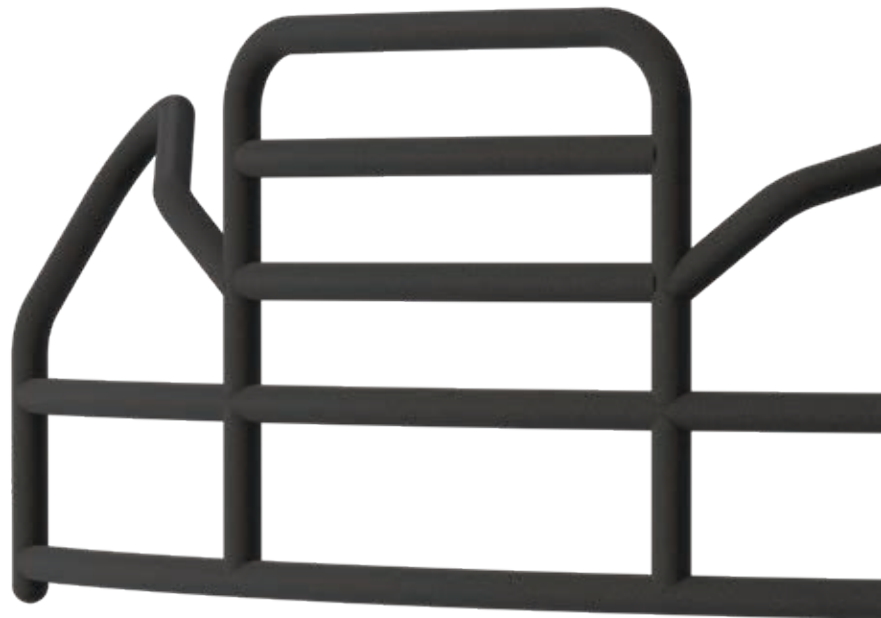

207520

Finish & Material



Finish:
E-coat and
bedliner-type
spray

Material:
Carbon steel





MAGLATCH™ GRILLE GUARD BRACKETS AND SAFETY PIN

- Vehicle-specific design for secure, no-drill install
- Fold-down latches use rare-earth magnets to secure grille guard upright
- Included safety pin adds security to magnets while maintaining simple operation (#206492)
- Built-in adjustments for easy install with variations in frame attachment points
- Zinc-plated finish for lasting rust resistance
- High-strength steel build for maximum rigidity
- Patent# 9,505,364

• See page 24 for application information

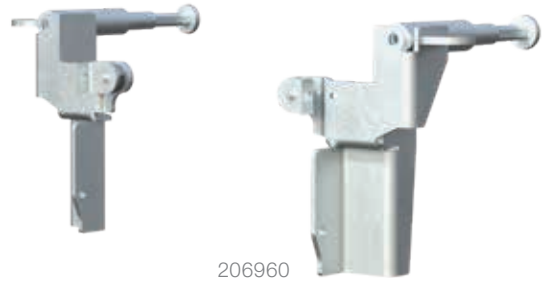

206960

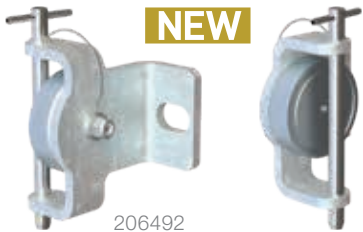

NEW

206492



MagLatch™ secures grille guard upright with rare-earth magnets



206492 safety pin adds security to the magnetic system

Part#	Description
206492 NEW	MagLatch™ safety pin



STANDARD GRILLE GUARD BRACKETS

- Vehicle-specific design for secure, no-drill install
- Fold-down latches use rubber bushings and T-handle locks to secure grille guard upright
- Zinc-plated finish for lasting rust resistance
- High-strength steel build for maximum rigidity

• See page 24 for application information

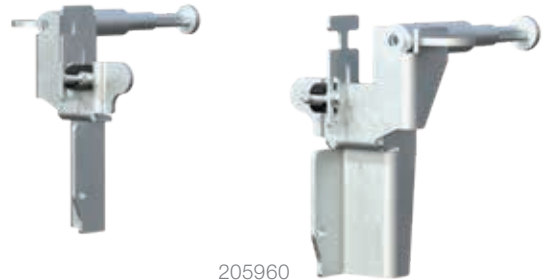

205960



MOUNTING BRACKET SPACER KIT

- For select trucks with all-metal bumpers
- Spaces out grille guard mounting brackets for bumper clearance
- Zinc-plated steel construction
- Includes four spacers

• See page 24 for application information



205696

Part#	Description
205696	For select trucks with all-metal bumpers



LICENSE PLATE BRACKET

- Universal design fits any RETRAC heavy-duty grille guard
- Provides a solid mounting point to keep license plate visible
- High-strength carbon steel construction with a durable black powder coat finish
- Includes license plate bracket and mounting hardware



205495



3" ACCESSORY MOUNTING TABS

- Fits most RETRAC grille guards or any 3" diameter tube
- 14mm hole for mounting lights, license plate bracket or other accessories
- Rust-free, powder-coated cast aluminum construction
- Includes two tabs and mounting hardware



390102



Part#	Finish
205495	Carbon steel with black powder coat

Part#	Fits	Finish
390102	3" tube diameters	Aluminum with black powder coat



GRILLE GUARD APPLICATION GUIDE

Heavy-Duty Grille Guards & Brackets

Make / Model	Years	Footnotes	Brackets Only	
			MagLatch™#	Standard#
Freightliner				
B2 / M2	09 - 19	--	206220	--
Cascadia	03 - 17	1	206760	205760
New Cascadia	18 - 19	2	206940	205940
	18 - 19	3	206960	205960
	18 - 19	4	206960	205960
Classic	91 - 18	--	--	205560
Columbia	01 - 18	10	--	205600
Coronado Glider	01 - 18	--	206120	--
Coronado SD	10 - 18	7	206140	--
	10 - 18	8	206160	--
Hino				
238	10 - 14	--	206200	--
258	10 - 18	--	206200	--
268	10 - 18	--	206200	--
338	10 - 18	--	206200	--
International				
8600	02 - 18	--	--	205740
9200	97 - 18	--	206580	205580
9400	97 - 18	--	206580	205580
DuraStar	01 - 18	--	--	205740
LT	08 - 18	3, 5	206680	205680
	08 - 18	5	206695	205695
ProStar	08 - 18	3, 5	206680	205680
	08 - 18	5	206695	205695
TranStar	01 - 18	--	--	205740
Kenworth				
T600	88 - 18	--	--	205660
T660	07 - 18	--	206720	205720
T680	11 - 19	--	206840	205840
T700	11 - 19	--	206840	205840
T800	87 - 18	--	206540	--
T880	13 - 18	--	206540	--
W900	82 - 19	11	206640	--
Mack				
Anthem	18 - 19	--	206980	--
		12	206990	--
CHU	07 - 18	--	206780	205780
	07 - 18	2	206880	205880
CXU	07 - 18	6	206780	205780
	07 - 18	2, 6	206880	205880

- Without 505HP or larger due to large radiator
- Excluding vehicles with fog lights
- Excluding vehicles with radar
- For vehicles with fog lights and radar
- All metal bumpers require kit #205696
- Steel, chrome bumper with plastic trim

- SD set forward axle
- SD set back axle
- Kick back bumper
- Painted three-piece standard bumper
- Excluding four-bolt bumper
- Low-mount brackets center fog lights in guard opening

	Tuff Guard® Guard Only#		Tuff Guard XT™ Guard Only#		Tuff Guard II™ Guard Only#		ProTec™ Guard Only#		ProTec Edge™ Guard Only#
	Polished#	Black#	Polished#	Black#	Polished#	Black#	Polished#	Black#	Black#
Freightliner									
	205504	205505	207504	207505	206510	206511	205517	205518	--
	205504	205505	--	--	206510	206511	205517	205518	--
	205504	205505	--	--	206510	206511	205517	205518	207520
	--	--	207504	207505	206510	206511	205517	205518	--
	--	--	207504	207505	--	--	--	--	--
	205500	205501	--	--	206510	206511	205515	205516	--
	205500	205501	--	--	206510	206511	205515	205516	--
	205500	205501	--	--	206510	206511	205515	205516	--
	205500	205501	--	--	206510	206511	205515	205516	--
	205500	205501	--	--	206510	206511	205515	205516	--
Hino									
	205504	205505	--	--	206510	206511	205517	205518	--
	205504	205505	--	--	206510	206511	205517	205518	--
	205504	205505	--	--	206510	206511	205517	205518	--
	205504	205505	--	--	206510	206511	205517	205518	--
International									
	205500	205501	--	--	206510	206511	205515	205516	--
	205500	205501	--	--	206510	206511	205515	205516	--
	205500	205501	--	--	206510	206511	205515	205516	--
	205504	205505	--	--	206510	206511	205517	205518	--
	205504	205505	--	--	206510	206511	205517	205518	--
	205504	205505	207504	207505	206510	206511	205517	205518	207520
	205504	205505	--	--	206510	206511	205517	205518	--
	205504	205505	207504	207505	206510	206511	205517	205518	207520
	205504	205505	--	--	206510	206511	205517	205518	--
Kenworth									
	205504	205505	--	--	206510	206511	205517	205518	--
	205504	205505	--	--	206510	206511	205517	205518	--
	205504	205505	--	--	206510	206511	205517	205518	207520
	205504	205505	--	--	206510	206511	205517	205518	207520
	205500	205501	207504	207505	206510	206511	205515	205516	207520
	205500	205501	207504	207505	206510	206511	205515	205516	207520
	205500	205501	--	--	206510	206511	205515	205516	--
Mack									
	205504	205505	--	--	206510	206511	205517	205518	--
	205504	205505	--	--	206510	206511	205517	205518	--
	205504	205505	--	--	206510	206511	205517	205518	--
	205504	205505	--	--	206510	206511	205517	205518	--
	205504	205505	--	--	206510	206511	205517	205518	--
	205504	205505	--	--	206510	206511	205517	205518	--

Applications continued on the following page



GRILLE GUARD APPLICATION GUIDE

Heavy-Duty Grille Guards & Brackets

Make / Model	Years	Footnotes	Brackets Only	
			MagLatch™#	Standard#
Peterbilt				
378	87 - 18	--	--	205520
	87 - 18	9	--	205520
379	87 - 18	--	--	205520
386	06 - 18	--	206720	205720
388	07 - 18	2	--	205820
389	07 - 18	2	--	205820
567	07 - 18	2, 7	--	205820
579	12 - 18	--	206840	205840
587	13 - 18	--	206870	205870
Volvo				
VNL 300	18 - 19	--	206180	--
	18 - 19	2	206180	--
	04 - 18	--	206620	205620
VNL 400	18 - 19	--	206180	--
	18 - 19	2	206180	--
VNL 430	04 - 18	--	206620	205620
VNL 630	04 - 18	--	206620	205620
VNL 670	04 - 18	--	206620	205620
VNL 730	04 - 18	--	206620	205620
VNL 740	18 - 19	--	206180	--
	18 - 19	2	206180	--
VNL 760	18 - 19	--	206180	--
	18 - 19	2	206180	--
VNL 780	04 - 18	--	206620	205620
VNL 860	18 - 19	--	206180	--
VNR 300	18 - 19	--	206180	--
	18 - 19	2	206180	--
VNR 400	18 - 19	--	206180	--
	18 - 19	2	206180	--
VNR 640	18 - 19	--	206180	--
	18 - 19	2	206180	--
Western Star				
4900SB	11 - 18	--	--	205900
5700	16 - 19	2	206940	205940
	16 - 19	3	206960	205960
	16 - 19	4	206960	205960

- Without 505HP or larger due to large radiator
- Excluding vehicles with fog lights
- Excluding vehicles with radar
- For vehicles with fog lights and radar
- All metal bumpers require kit #205696
- Steel, chrome bumper with plastic trim

- SD set forward axle
- SD set back axle
- Kick back bumper
- Painted three-piece standard bumper
- Excluding four-bolt bumper
- Low-mount brackets center fog lights in guard opening

	Tuff Guard® Guard Only#		Tuff Guard XT™ Guard Only#		Tuff Guard II™ Guard Only#		ProTec™ Guard Only#		ProTec Edge™ Guard Only#
	Polished#	Black#	Polished#	Black#	Polished#	Black#	Polished#	Black#	Black#
Peterbilt									
	205500	205501	--	--	206510	206511	205515	205516	--
	205504	205505	--	--	206510	206511	205517	205518	--
	205500	205501	--	--	206510	206511	205515	205516	--
	205504	205505	--	--	206510	206511	205517	205518	--
	205500	205501	207504	207505	206510	206511	205515	205516	--
	205500	205501	207504	207505	206510	206511	205515	205516	--
	205500	205501	--	--	206510	206511	205515	205516	--
	205504	205505	--	--	206510	206511	205517	205518	207520
	205504	205505	--	--	206510	206511	205517	205518	--
Volvo									
	--	--	--	--	206510	206511	205517	205518	207520
	205504	205505	--	--	206510	206511	205517	205518	207520
	205500	205501	--	--	206510	206511	205515	205516	207520
	--	--	--	--	206510	206511	205517	205518	207520
	205504	205505	--	--	206510	206511	205517	205518	207520
	205500	205501	--	--	206510	206511	205515	205516	207520
	205500	205501	--	--	206510	206511	205515	205516	207520
	205500	205501	--	--	206510	206511	205515	205516	207520
	--	--	--	--	206510	206511	205517	205518	207520
	205504	205505	--	--	206510	206511	205517	205518	207520
	--	--	--	--	206510	206511	205517	205518	207520
	205504	205505	--	--	206510	206511	205517	205518	207520
	205500	205501	--	--	206510	206511	205515	205516	207520
	--	--	--	--	206510	206511	205517	205518	207520
	--	--	--	--	206510	206511	205515	205516	--
	205500	205501	--	--	206510	206511	205515	205516	--
	--	--	--	--	206510	206511	205515	205516	--
	205500	205501	--	--	206510	206511	205515	205516	--
	--	--	--	--	206510	206511	205515	205516	--
	205500	205501	--	--	206510	206511	205515	205516	--
Western Star									
	205504	205505	--	--	206510	206511	205517	205518	--
	205504	205505	--	--	206510	206511	205517	205518	207520
	--	--	207504	207505	206510	206511	205517	205518	--
	--	--	207504	207505	--	--	--	--	--



TUFF GUARD® VAN GRILLE GUARDS

KEY FEATURES

Powder-coated stainless steel construction for maximum corrosion resistance

3" diameter, 14-gauge stainless steel tube design for added vehicle protection

Product Details

- Durable, textured black powder coat for a sleek, professional finish
- Solid, bolt-on installation using pre-existing mounting points (some models may require minor drilling into plastic)
- High-strength steel mounting brackets with a durable black powder coat finish
- Limited lifetime warranty (see last page for details)
- [See adjacent page for application information](#)



205530

Finish & Material



Finish:
Textured black

Material:
Stainless steel

3" ACCESSORY MOUNTING TABS

- Fits most RETRAC grille guards or any 3" diameter tube
- 14mm hole for mounting lights, license plate bracket or other accessories
- Rust-free, powder-coated cast aluminum construction
- Includes two tabs and mounting hardware



390102



Part#	Fits	Finish
390102	3" tube diameters	Aluminum with black powder coat



TUFF GUARD® VAN APPLICATION GUIDE

Tuff Guard® Van Grille Guards and Mounting Brackets

Make / Model	Years	Footnotes	Guard Only	Brackets Only
			Black#	Bracket#
Dodge				
Sprinter 2500	07 - 09	--	205530	205860
Sprinter 3500	07 - 09	--	205530	205860
Ford				
Transit	15 - 17	--	205530	205920
Freightliner				
Sprinter 2500	07 - 13	--	205530	205860
	14 - 17	1	205530	205930
Sprinter 3500	07 - 13	--	205530	205860
	14 - 17	1	205530	205930
Mercedes-Benz				
Sprinter 2500	10 - 13	--	205530	205860
	14 - 17	1	205530	205930
Sprinter 3500	10 - 13	--	205530	205860
	14 - 17	1	205530	205930
Ram				
ProMaster 1500	14 - 18	--	205530	205910
ProMaster 2500	14 - 18	--	205530	205910
ProMaster 3500	14 - 18	--	205530	205910

1. Will interfere with parking sensors







HEAVY-DUTY MIRRORS

ORIGINAL EQUIPMENT FORM AND FIT

In the trucking industry, safety and a professional image are the cornerstones of your customer's career. The RETRAC heavy-duty mirror line is designed to promote both. From our west coast mirrors and assemblies to our modern pedestal-mount mirrors, our products are built for excellence in both look and functionality. Our heavy-duty mirrors are made to provide a perfect replacement for existing OEM mirrors, and most are available with heated, lighted and motorized options.



FEATURED PRODUCTS



West coast mirror heads

RETRAC offers a wide variety of west coast mirrors to provide the perfect OE replacement for any heavy-duty or medium-duty truck.



Aerodynamic mirror heads

Engineered to promote maximum efficiency and safety, aerodynamic mirrors feature a sleek design to reduce wind resistance and drag.



Custom mirror assemblies

These vehicle-specific mirror mounts and heads integrate with the truck design, offering an exact replacement with no drilling required.

PRODUCT INDEX



34

**Aerodynamic
West Coast
Mirror Heads**



37

**Off-Road
West Coast
Mirror Heads**



38

**Pedestal-Mount
Mirror
Assemblies**



39

**West Coast
Mirror Heads**



46

**Custom West
Coast Mirror
Assemblies**



46

**Universal
Mirror
Assemblies**

AERODYNAMIC WEST COAST MIRROR HEADS

- Aerodynamic head design for reduced drag and wind resistance
- Original equipment, west coast style to provide a perfect OEM replacement
- Universal clamp easily attaches to any 3/4" to 1-1/4" diameter tube
- Flat mirror provides an extra-wide view to minimize blind spots
- First-surface electro-chrome glass eliminates glare for maximum safety
- Motorized glass angles horizontally and vertically with 4-way actuator (select models)
- Automated smart heater evenly defrosts glass to maintain visibility (select models)
- Marker light provides additional safety by signaling other drivers (select models)
- Injection-molded ABS plastic available in bright chrome or paintable black



Convex aerodynamic mirrors available, see page 52

Part#	Flat Glass Size (W x H)	Convex Glass Size (W x H)	Finish	Adjustable Glass	Heated	Lighted
Single-Vision						
610872	8" x 17"	--	Black	--	--	--
610873	8" x 17"	--	Black	--	Yes	--
610878	8" x 17"	--	Chrome	--	--	--
610879	8" x 17"	--	Chrome	--	Yes	--
613410	8" x 19"	--	Black	Motorized	--	--
613412	8" x 19"	--	Black	Motorized	Yes	--
613414	8" x 19"	--	Black	Motorized	Yes	Yes
613510	8" x 19"	--	Black	Manual	--	--
613512	8" x 19"	--	Black	Manual	Yes	--
613514	8" x 19"	--	Black	Manual	Yes	Yes
613411	8" x 19"	--	Chrome	Motorized	--	--
613413	8" x 19"	--	Chrome	Motorized	Yes	--
613415	8" x 19"	--	Chrome	Motorized	Yes	Yes
613511	8" x 19"	--	Chrome	Manual	--	--
613513	8" x 19"	--	Chrome	Manual	Yes	--
613515	8" x 19"	--	Chrome	Manual	Yes	Yes
Dual-Vision						
613420	7" x 13-1/2"	7" x 4-1/2"	Black	Motorized	--	--
613422	7" x 13-1/2"	7" x 4-1/2"	Black	Motorized	Yes	--
613424	7" x 13-1/2"	7" x 4-1/2"	Black	Motorized	Yes	Yes
613520	7" x 13-1/2"	7" x 4-1/2"	Black	Manual	--	--
613522	7" x 13-1/2"	7" x 4-1/2"	Black	Manual	Yes	--
613524	7" x 13-1/2"	7" x 4-1/2"	Black	Manual	Yes	Yes
613421	7" x 13-1/2"	7" x 4-1/2"	Chrome	Motorized	--	--
613423	7" x 13-1/2"	7" x 4-1/2"	Chrome	Motorized	Yes	--
613425	7" x 13-1/2"	7" x 4-1/2"	Chrome	Motorized	Yes	Yes
613521	7" x 13-1/2"	7" x 4-1/2"	Chrome	Manual	--	--
613523	7" x 13-1/2"	7" x 4-1/2"	Chrome	Manual	Yes	--
613525	7" x 13-1/2"	7" x 4-1/2"	Chrome	Manual	Yes	Yes

AERODYNAMIC WEST COAST MIRROR HEADS

See page 36 for replacement glass



610873



610879



613410
613412
613512
613514
front



613420
613422
613424
613522
613524
front



613410
613412
613512
613420
613422
613522
back



613414
613514
613424
613524
back



613411
613413
613414
613415
613513
613515
front



613421
613423
613425
613523
613525
front



613411
613413
613513
613421
613423
613523
back



613415
613515
613425
613525
back



613510
front



613520
front



613510 and 613520
back



613511
front



613521
front



613511 and 613521
back

AERODYNAMIC WEST COAST MIRROR HEAD REPLACEMENT GLASS

- Flat mirror provides an extra-wide view to minimize blind spots
- Convex glass provides a wide view of blind spots
- First-surface electro-chrome glass eliminates glare for maximum safety
- Compatible with heated and non-heated mirrors (unless specified)



613474



613495



613496



613465



610885 (heated)
610884 (not heated)



613460

Part#	Description	Heated	Flat Glass Size (W x H)	Convex Glass Size (W x H)
Single-Vision				
613465†	Flat glass	Yes	8" x 19"	--
610885	Flat glass	Yes	8" x 17"	--
610884	Flat glass	--	8" x 17"	--
Dual-Vision				
613474†	Flat and convex glass kit	Yes	7" x 13-1/2"	7" x 4-1/2"
613495†	Flat glass	Yes	7" x 13-1/2"	--
613496†	Convex glass	Yes	--	7" x 4-1/2"
Replacement Switch				
613460	4-way actuator switch for dual-vision mirrors			

† Compatible with heated and non-heated mirrors

OFF-ROAD WEST COAST MIRROR HEADS

- Shatterproof glass ideal for agricultural, mining and military applications
- E-stamped approved and certified
- Universal clamp sizes to easily mount onto an existing loop
- Semi-convex mirror provides an extra-wide view to minimize blind spots
- First-surface electro-chrome glass eliminates glare for maximum safety
- Black injection-molded ABS plastic can be painted to match any vehicle



611770



611773



610295



611774



610290

Part#	Glass Size (W x H)	Finish	Vision Type	Fits Tube
611770	7" x 9"	Black ABS plastic	Single-vision	5/8" to 7/8"
611773	7" x 9"	Black ABS plastic	Single-vision	1" to 1-1/4"
610295	8" x 16"	Black ABS plastic	Single-vision	5/8" to 3/4"
610290	9" x 17"	Black ABS plastic	Single-vision	5/8" to 7/8"
611774	9" x 17"	Black ABS plastic	Single-vision	1" to 1-1/4"

PEDESTAL-MOUNT MIRROR ASSEMBLIES

- No-drill, vehicle-specific design to perfectly match the factory holes
- Aerodynamic head design for reduced drag and wind resistance
- Original equipment style to provide a perfect OEM replacement
- Motorized glass angles vertically and horizontally with 4-way actuator (switch not included)
- Automated smart heater evenly defrosts glass to maintain visibility
- Computer-printed heating element self-regulates based on ambient temperatures
- Flat mirror provides a wide view to minimize blind spots
- Convex glass helps eliminate blind spots for safer maneuvering
- First-surface electro-chrome glass eliminates glare for maximum safety
- Chrome injection-molded ABS plastic construction for a bright, rust-free accent



Pedestal-Mount Mirror Assemblies

Make / Model	Sub Model	Years	Flat Glass Size (W x H)	Convex Glass Size (W x H)	Motorized	Heated	Vision Type	Driver / Left Part#	Passenger / Right Part#
Freightliner									
Cascadia	113	09 - 19	7" x 12-1/2"	7" x 5"	Yes	Yes	Dual-vision	612165	612166
		09 - 19	--	8" x 6"	--	--	Single-vision	612167	612168
	125	08 - 19	7" x 12-1/2"	7" x 5"	Yes	Yes	Dual-vision	612165	612166
		08 - 19	--	8" x 6"	--	--	Single-vision	612167	612168

MOTORIZED WEST COAST MIRROR HEADS

- Motorized glass angles vertically and horizontally with 4-way actuator
- Universal mounts easily attach to all standard loops
- Original equipment, west coast style to fit most class 8 trucks
- Automated smart heater evenly defrosts glass to maintain visibility (select models)
- Marker light provides additional safety by signaling other drivers (select models)
- First-surface electro-chrome glass eliminates glare for maximum safety
- Stamped metal construction with rigid mounts to reduce vibrations
- Polished stainless steel backing for a bright, rust-resistant accent
- Includes 14' electrical cord and switch for motorized adjustment



Part#	Flat Glass Size (W x H)	Convex Glass Size (W x H)	Finish	Vision Type	Heated	Lighted
Mirror Heads						
607002	7" x 16"	--	Polished stainless	Single-vision	--	--
607004	7" x 16"	--	Polished stainless	Single-vision	Yes	--
607008	7" x 16"	--	Polished stainless	Single-vision	Yes	Yes
607012	7" x 16"	6-1/4" x 4"	Polished stainless	Dual-vision	--	--
607014	6-1/4" x 10-3/4"	6-1/4" x 4"	Polished stainless	Dual-vision	Yes	--
607018	6-1/4" x 10-3/4"	6-1/4" x 4"	Polished stainless	Dual-vision	Yes	Yes
Replacement Switch						
613460	4-way actuator switch for dual-vision mirrors					

ECONOMY WEST COAST MIRROR HEADS

- Universal mounts easily attach to all standard loops
- Original equipment, west coast style to fit most class 8 trucks
- Flat mirror provides a wide view to help minimize blind spots
- Stamped aluminum construction to be strong, lightweight and rust-free

Part#	Bulk 10-Pack#	Glass Size (W x H)	Finish	Vision Type
610321	--	6" x 16"	Brushed aluminum	Single-vision
--	610278	6" x 16"	Brushed aluminum with black plastic end caps	Single-vision





CHEVRON WEST COAST MIRROR HEADS

- Bright chevrons add style and visibility to the vehicle
- Universal flange mounts easily attach to all standard loops and swedged loops
- Automated smart heater evenly defrosts glass to maintain visibility (select models)
- Marker light provides additional safety by signaling other drivers (select models)
- Flat mirror provides a wide view to help minimize blind spots
- First-surface electro-chrome glass eliminates glare for maximum safety
- Stamped aluminum construction to be strong, lightweight and rust-free
- Bright, anodized finish for enhanced corrosion resistance



600960
601010
601142
601165
601250
front



600932
front



601017
front



600932
601017
back



601142
back



600960
back



601010
back



601165
back



601250
back

Part#	Flat Glass Size (W x H)	Convex Glass Size (W x H)	Finish	Vision Type	Heated	Lighted
Yellow Chevron Style						
600932	6" x 16"	--	Anodized aluminum	Single-vision	--	--
600960	6" x 16"	--	Anodized aluminum	Single-vision	Yes	--
601010	6" x 16"	--	Anodized aluminum	Single-vision	Yes	Yes
601017	6" x 12"	6" x 4"	Anodized aluminum	Dual-vision	--	--
Embossed Chevron Style						
601142	6" x 16"	--	Anodized aluminum	Single-vision	--	--
601165*	6" x 16"	--	Anodized aluminum	Single-vision	Yes	--
601250	6" x 16"	--	Anodized aluminum	Single-vision	Yes	Yes

* Continued while supplies last

RIB-BACK & BUBBLE-BACK WEST COAST MIRROR HEADS

- Universal stud mounts easily attach to all standard loops
- Original equipment style to provide a perfect OEM replacement
- Built-in heater evenly defrosts glass to maintain visibility (select models)
- Flat mirror provides a wide view to help minimize blind spots



Part#	Glass Size (W x H)	Finish	Vision Type	Heated
Rib-Back Style				
610226	7" x 16"	Polished stainless	Single-vision	--
610231	7" x 16"	Polished stainless	Single-vision	Yes
610216	7" x 16"	Carbon steel with black enamel	Single-vision	--
610221	7" x 16"	Carbon steel with black enamel	Single-vision	Yes
610236	7" x 16"	Carbon steel with white enamel	Single-vision	--
Bubble-Back Style				
610256	7" x 16"	Polished stainless	Single-vision	--
610246	7" x 16"	Carbon steel with black enamel	Single-vision	--
610266	7" x 16"	Carbon steel with white enamel	Single-vision	--
610271*	7" x 16"	Carbon steel with white enamel	Single-vision	Yes

* Continued while supplies last

PYRAMID-BACK WEST COAST MIRROR HEADS

- Original equipment, pyramid-back style to provide a perfect OEM replacement
- Universal stud mounts easily attach to all standard loops
- Automated smart heater evenly defrosts glass to maintain visibility (select models)
- Flat mirror provides a wide view to help minimize blind spots
- First-surface electro-chrome glass eliminates glare for maximum safety



600682



600807



600710



600835



600685

Part#	Glass Size (W x H)	Finish	Vision Type	Heated	Lighted
600807	7" x 16"	Polished stainless	Single-vision	--	--
605403	7" x 16"	Polished stainless	Single-vision	--	--
610331	7" x 16"	Polished stainless	Single-vision	--	--
600835	7" x 16"	Polished stainless	Single-vision	Yes	--
610204	7" x 16"	Polished stainless	Single-vision	Yes	--
610336	7" x 16"	Polished stainless	Single-vision	Yes	--
605409†	7" x 16"	Polished stainless	Single-vision	Yes	--
605448‡	7" x 16"	Polished stainless	Single-vision	Yes	--
600682	7" x 16"	Carbon steel with white powder coat	Single-vision	--	--
600710	7" x 16"	Carbon steel with white powder coat	Single-vision	Yes	--
600685	7" x 16"	Carbon steel with black powder coat	Single-vision	--	--
610351	7" x 16"	Carbon steel with black powder coat	Single-vision	--	--
610356*	7" x 16"	Carbon steel with black powder coat	Single-vision	Yes	--

† #605409 includes GM-specific wiring harness (29" wire length)

‡ #605448 includes Isuzu-specific wiring harness (42.37" wire length)

* Continued while supplies last

PYRAMID-BACK WEST COAST MIRROR HEADS



605403



610204



GM plug
(29" wire)

605409



Isuzu plug
(42.37" wire)

605448



610356



610336



610331



610351

ANGLE-BACK WEST COAST MIRROR HEADS

- Original equipment, heavy-duty style to provide a perfect OEM replacement
- Universal stud mounts easily attach to all standard loops
- Built-in heater evenly defrosts glass to maintain visibility (select models)
- Flush-mount marker light provides additional safety by signaling other drivers (select models)
- Flat mirror provides a wide view to help minimize blind spots
- First-surface electro-chrome glass eliminates glare for maximum safety



Part#	Flat Glass Size (W x H)	Convex Glass Size (W x H)	Finish	Vision Type	Heated	Lighted
Single-Vision						
601272	7" x 16"	--	Polished stainless	Single-vision	--	--
601292	7" x 16"	--	Polished stainless	Single-vision	--	--
610301	7" x 16"	--	Polished stainless	Single-vision	--	--
610311	7" x 16"	--	Polished stainless	Single-vision	--	Yes
601285	7" x 16"	--	Polished stainless	Single-vision	Yes	--
601305	7" x 16"	--	Polished stainless	Single-vision	Yes	--
610306	7" x 16"	--	Polished stainless	Single-vision	Yes	--
601288	7" x 16"	--	Polished stainless	Single-vision	Yes	Yes
610316	7" x 16"	--	Polished stainless	Single-vision	Yes	Yes
605400	7" x 16"	--	Black ABS plastic	Single-vision	--	--
Dual-Vision						
601268	6" x 10"	6" x 4"	Polished stainless	Dual-vision	--	--
601274	6" x 10"	6" x 4"	Polished stainless	Dual-vision	Yes	--

ANGLE-BACK WEST COAST MIRROR HEADS





CUSTOM WEST COAST MIRROR ASSEMBLIES

- Original equipment, heavy-duty style to provide a perfect OEM replacement
- No-drill, vehicle-specific design to perfectly match the factory holes
- Patented retractable assembly for added clearance whenever needed
- Universal 5/16" studs easily attach the mirror head to the loop
- Stainless steel, 7" x 16" flat mirror provides a wide view to help minimize blind spots
- First-surface electro-chrome glass eliminates glare for maximum safety
- Bright, anodized yellow chevrons add style and visibility to the vehicle (#603500, #603501)
- Mounting assembly constructed from rust-free, polished stainless steel
- Includes mirror head, assembly and hardware



611642

Custom West Coast Mirror Assemblies

Make / Model	Sub Model	Foot Notes	Years	Driver-Side#	Pass-Side#
Chevrolet					
C3500HD	--	--	91 - 02	611642	611643
C60 Kodiak	--	--	90 - 96	611642	611643
C6500 Kodiak	--	--	97 - 02	611642	611643
Ford					
F600	--	--	70 - 94	605051	605053
F700	--	--	70 - 98	605051	605053
F7000	--	--	70 - 87	605051	605053
L800	--	--	80 - 85	605051	605053
L8000	--	--	81 - 88	605051	605053
L9000	--	--	81 - 97	605051	605053
Freightliner					
FL50	--	--	95 - 05	612116	612118
FL60	--	--	92 - 04	612116	612118
FL70	--	--	93 - 05	612116	612118
FL80	--	--	93 - 06	612116	612118
FL106	--	--	94 - 03	612116	612118
FL112	Base	--	96 - 03	612116	612118
FLD112	--	--	91 - 06	612101	612103
FLD120	--	--	89 - 11	612101	612103
FLD120SD	--	--	03 - 12	612101	612103
FLD132	--	--	01 - 11	612101	612103
GMC					
C3500HD	--	--	91 - 02	611642	611643
C6000 Topkick	--	--	90 - 96	611642	611643
C6500 Topkick	--	--	97 - 02	611642	611643

1. Mirror head not included
*Painted steel with 6" x 16" mirror

Custom West Coast Mirror Assemblies

Make / Model	Sub Model	Foot Notes	Years	Driver-Side#	Pass-Side#
International					
4200	--	--	02 - 10	611761	611763
		1	02 - 10	611786	611788
4300 / 4400	--	--	02 - 18	611761	611763
		1	02 - 18	611786	611788
4700	--	--	01 - 08	611761	611763
		1	01 - 08	611786	611788
7300 / 7400 / 7500 / 7600	--	--	02 - 18	611761	611763
		1	02 - 18	611786	611788
7600	--	--	03 - 17	611761	611763
		1	03 - 17	611786	611788
7700	--	--	05 - 07	611761	611763
		1	05 - 07	611786	611788
8500	--	--	02 - 07	611761	611763
		1	02 - 07	611786	611788
S-Series	--	--	80 - 90	603515	603516
				603500*	603501*
Mack					
CH	--	--	89 - 03	611781	611783
CH	--	--	90 - 05	611781	611783
CHN	--	--	06 - 07	611781	611783
CHU	--	--	08 - 18	611781	611783

1. Mirror head not included
*Painted steel with 6" x 16" mirror



605051



612116



612101



611761



611786



611781



603515



603500



UNIVERSAL CONVENTIONAL MIRROR ASSEMBLY

- Universal design fits a wide variety of heavy-duty applications
- Patented retractable assembly for added clearance whenever needed
- Universal stud mounts easily attach the mirror head to the loop
- 7" x 16" flat mirror provides a wide view to help minimize blind spots
- First-surface electro-chrome glass eliminates glare for maximum safety
- Polished stainless steel construction for a bright, rust-free accent
- Includes mirror head, mounting assembly and hardware
- Fits driver side or passenger side

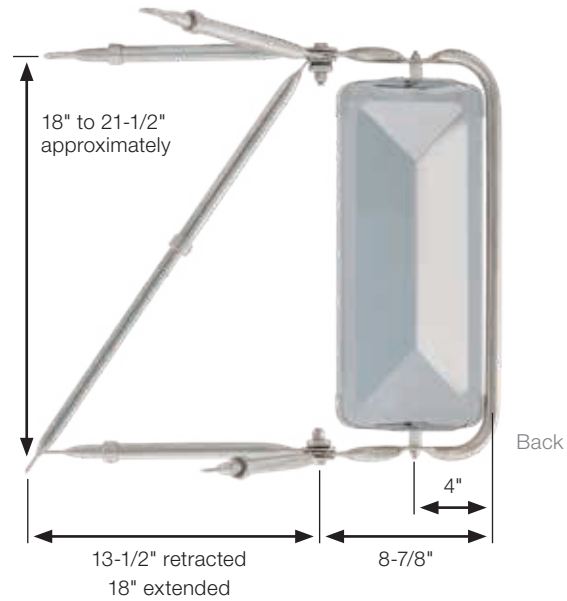

Part#	Glass Size (W x H)	Finish
603862	7" x 16"	Polished stainless



UNIVERSAL CABOVER MIRROR ASSEMBLY

- Universal design fits a wide variety of heavy-duty applications
- Patented retractable assembly for added clearance whenever needed
- Vertically adjustable to fit 20" to 34" window and door sizes
- Universal clamp mounts easily attach the mirror head to the loop
- 7" x 16" flat mirror provides a wide view to help minimize blind spots
- First-surface electro-chrome glass eliminates glare for maximum safety
- Polished stainless steel construction for a bright, rust-free accent
- Includes mirror head, mounting assembly and hardware
- Fits driver side or passenger side

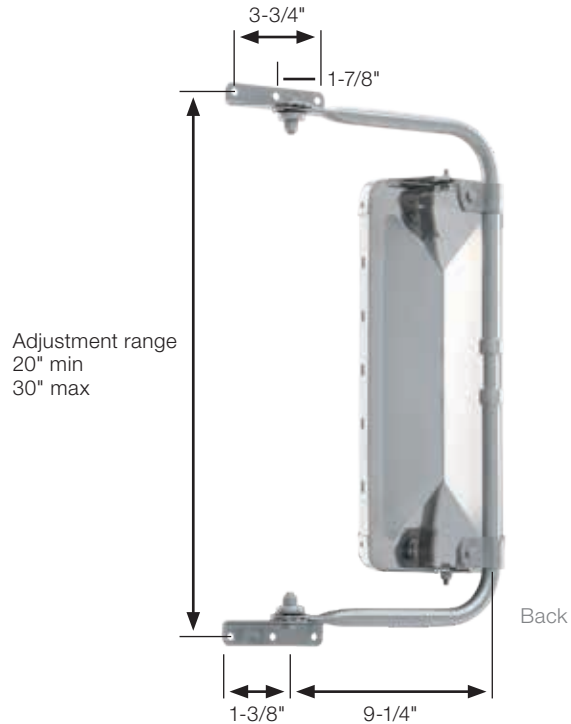

Part#	Glass Size (W x H)	Finish
603890	7" x 16"	Polished stainless





CONVEX & SAFETY MIRRORS

RELIABILITY FOR THE ROAD AHEAD

No matter what your customers are hauling, having maximum visibility from the truck cab is essential for the safety and success of the job. RETRAC convex mirrors and safety assemblies give your customers eyes on the road, featuring convex glass, OEM styling and tested construction. RETRAC convex mirror heads are available in multiple styles, and our safety assemblies feature a universal design to fit a wide range of applications.



FEATURED PRODUCTS



Safety mirror assemblies

With a universal design, these assemblies allow our safety mirrors to be mounted on a variety of trucks, adding visibility on the road.



Offset-mount mirror heads

The offset mounting option provides an extended view and wider range of adjustment for maximum visibility of blind spots.



Center-mount mirror heads

Center-mount safety mirrors offer enhanced vibration resistance, and most are available with a plastic ball stud for rust-free adjustment.

PRODUCT INDEX



52

Aerodynamic Mirror Heads



53

Bubble Mirror Heads



54

Center-Mount Mirror Heads



56

Offset-Mount Mirror Heads



58

Rectangular Mirror Heads



58

Stick-On Mirrors



59

Rectangular Utility Mirror Assembly



59

Look-Down Mirror Assemblies



60

Safety Mirror Assemblies



61

Rear-Mount Safety Mirror Assemblies

AERODYNAMIC CONVEX MIRROR HEADS

- Aerodynamic head design for reduced drag and wind resistance
- Original equipment style to provide a perfect OEM replacement
- Universal clamp easily attaches to any 3/4" to 1-1/4" diameter tube
- Automated smart heater evenly defrosts glass to maintain visibility (select models)
- Convex glass helps eliminate blind spots for safer maneuvering
- First-surface electro-chrome glass eliminates glare for maximum safety
- Injection-molded ABS plastic available in bright chrome or paintable black



Part#	Glass Size (W x H)	Finish	Heated
Mirror Heads			
610875	8" x 8-1/2"	Black	--
610876	8" x 8-1/2"	Black	Yes
610881	8" x 8-1/2"	Chrome	--
610882	8" x 8-1/2"	Chrome	Yes
Replacement Glass			
610886	8" x 8-1/2"	--	--
610887	8" x 8-1/2"	--	Yes



BUBBLE MIRROR HEADS

- Bubble glass helps eliminate blind spots for safer maneuvering
- Center-mount ball stud for added stability and easy tilt adjustment
- Plastic ball stud will never rust and will not crack the mirror backing (select models)
- Vibration-tested and salt-spray-tested for a minimum of 360 hours to ensure long life



609955
semi-bubble



610775
full bubble



604947
semi-bubble



609955



609965



609957



610775



609970



610750



604945



604946



604953



604954



604947

Part#	Glass Diameter	Finish	Bubble Depth	J-Bracket Included	Ball Stud
609955	8"	Polished stainless	Semi-bubble	--	Metal
609965	8"	Polished stainless	Semi-bubble	--	Plastic
609957	8"	Polished stainless	Semi-bubble	Yes	Metal
610775	8"	Polished stainless	Full bubble	--	Metal
609970	8"	Carbon steel with black powder coat	Semi-bubble	--	Plastic
610750	8"	Carbon steel with black powder coat	Full bubble	--	Metal
604945	10"	Black plastic	Semi-bubble	--	Plastic
604946	10"	White plastic	Semi-bubble	--	Plastic
604953	10"	Polished stainless	Semi-bubble	--	Metal
604954*	10"	Carbon steel with black powder coat	Semi-bubble	--	Metal
604947	12"	Black plastic	Semi-bubble	--	Plastic

* Continued while supplies last

CENTER-MOUNT CONVEX MIRROR HEADS

- Center-mount ball stud allows for added stability and easy tilt adjustment
- Convex glass helps eliminate blind spots for safer maneuvering
- Built-in heater evenly defrosts glass to maintain visibility (select models)
- Plastic ball stud will never rust and will not crack the mirror backing (select models)
- Vibration-tested and salt-spray-tested for a minimum of 360 hours to ensure long life

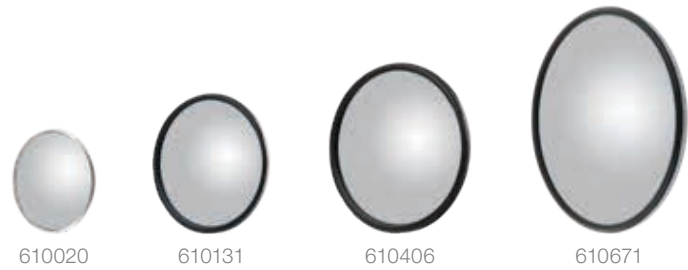

Part#	Glass Diameter	Finish	Heated	J-Bracket Included	Ball Stud
610020	3-3/4"	Brushed aluminum	--	--	Metal
610146	5"	Polished stainless	--	--	Metal
610148	5"	Polished stainless	--	Yes	Metal
604950	5"	Brushed aluminum	--	--	Metal
610076*	5"	Brushed aluminum	--	--	Metal
610131	5"	Carbon steel with black powder coat	--	--	Metal
610133	5"	Carbon steel with black powder coat	--	Yes	Metal
610401	6"	Polished stainless	--	--	Plastic
610191	6"	Polished stainless	--	--	Metal
610403	6"	Polished stainless	--	Yes	Plastic
610193	6"	Polished stainless	--	Yes	Metal
610176	6"	Anodized aluminum	--	--	Metal
610178	6"	Anodized aluminum	--	Yes	Metal
610161	6"	Aluminum with black powder coat	--	--	Metal
610406	6"	Carbon steel with black powder coat	--	--	Metal
610408	6"	Carbon steel with black powder coat	--	Yes	Metal
604976	7-1/2"	Polished stainless	--	--	Metal
604978	7-1/2"	Polished stainless	--	Yes	Metal
609816	7-1/2"	Polished stainless	--	--	Plastic
609818	7-1/2"	Polished stainless	--	Yes	Plastic
604983	7-1/2"	Carbon steel with black powder coat	--	Yes	Metal
604898	8"	Polished stainless	--	--	Plastic
610671	8"	Polished stainless	--	--	Metal
610673	8"	Polished stainless	--	Yes	Metal
610703	8"	Polished stainless	--	Yes	Plastic
610676	8"	Polished stainless	Yes	--	Metal
604895	8"	Polished stainless	Yes	--	Plastic
610711	8"	Carbon steel with black powder coat	--	--	Metal
604913	8"	Carbon steel with black powder coat	--	--	Plastic
610713	8"	Carbon steel with black powder coat	--	Yes	Metal
610743	8"	Carbon steel with black powder coat	--	Yes	Plastic
604915*	8"	Carbon steel with black powder coat	Yes	--	Plastic

* Continued while supplies last

CENTER-MOUNT CONVEX MIRROR HEADS



610020



610146



610148



604950



610076



610131



610133



610401



610191



610403



610193



610176



610178



610161



610406



610408



604976



604978



609816



609818



604983



604898



610671



610673



610703



610676



604895



610711



604913



610713



610743



604915

OFFSET-MOUNT CONVEX MIRROR HEADS

- Offset ball stud provides a wider view with easy tilt adjustment
- Convex glass helps eliminate blind spots for safer maneuvering
- Built-in heater evenly defrosts glass to maintain visibility (select models)
- Plastic ball stud will never rust and will not crack the mirror backing (select models)
- Vibration-tested and salt-spray-tested for a minimum of 360 hours to ensure long life



Part#	Glass Diameter	Finish	Heated	J-Bracket Included	Ball Stud
609876	7-1/2"	Polished stainless	--	--	Plastic
609836	7-1/2"	Polished stainless	--	--	Metal
609878	7-1/2"	Polished stainless	--	Yes	Plastic
609838	7-1/2"	Polished stainless	--	Yes	Metal
609841	7-1/2"	Carbon steel with black powder coat	--	--	Metal
609843	7-1/2"	Carbon steel with black powder coat	--	Yes	Metal
604798	8"	Polished stainless	--	--	Plastic
610551	8"	Polished stainless	--	--	Metal
610583	8"	Polished stainless	--	Yes	Plastic
610553	8"	Polished stainless	--	Yes	Metal
604793	8"	Polished stainless	Yes	--	Plastic
610556	8"	Polished stainless	Yes	--	Metal
604827	8"	Carbon steel with black powder coat	--	--	Plastic
610591	8"	Carbon steel with black powder coat	--	--	Metal
610623	8"	Carbon steel with black powder coat	--	Yes	Plastic
610593	8"	Carbon steel with black powder coat	--	Yes	Metal
610596	8"	Carbon steel with black powder coat	Yes	--	Metal
609936	8-1/2"	Polished stainless	--	--	Plastic
609896	8-1/2"	Polished stainless	--	--	Metal
609938	8-1/2"	Polished stainless	--	Yes	Plastic
609898	8-1/2"	Polished stainless	--	Yes	Metal
609946	8-1/2"	Polished stainless	Yes	--	Plastic
609901	8-1/2"	Carbon steel with black powder coat	--	--	Metal
609903	8-1/2"	Carbon steel with black powder coat	--	Yes	Metal

OFFSET-MOUNT CONVEX MIRROR HEADS



609876



609836



609878



609838



609841



609843



604798



610551



610583



610553



604793



610556



604827



610591



610623



610593



610596



609936



609896



609938



609898



609946



609901



609903

RECTANGULAR CONVEX MIRROR HEADS

- Center-mount ball stud for added stability and easy tilt adjustment (select models)
- Convex glass helps eliminate blind spots for safer maneuvering
- Vibration-tested and salt-spray-tested for a minimum of 360 hours to ensure long life



Part#	Glass Diameter (W x H)	Finish	Ball Stud
610450	5-1/2" x 7-1/2"	Stainless steel	Metal
610465	5-1/2" x 7-1/2"	Aluminum with black powder coat	Metal
610456	5-1/2" x 7-1/2"	Anodized aluminum	Metal
604778*	5-1/2" x 7-1/2"	Anodized aluminum	--
604776*	5-1/2" x 7-1/2"	Anodized aluminum	--

* Continued while supplies last

STICK-ON CONVEX MIRRORS

- Convex glass helps eliminate blind spots for safer maneuvering
- Tape backing allows for fast, easy installation on existing mirrors
- Double-sided, water-resistant tape to easily outlast the elements



Part#	Glass Size (W x H)	Style	Finish
610851	2" x 1"	Wedge	Black ABS plastic
610854*	3-3/4" x 2-1/2"	Wedge	Black ABS plastic
604770	5-1/2" x 4"	Rectangular	Black ABS plastic
604771	2" diameter	Round	Stamped aluminum
604772	3" diameter	Round	Stamped aluminum
604773	3-3/4" diameter	Round	Stamped aluminum

* Continued while supplies last



Easily sticks onto a pre-existing mirror for added visibility



RECTANGULAR CONVEX UTILITY MIRROR ASSEMBLY

- Universal I-bracket fits a wide variety of heavy-duty applications
- Adjustable design to find the perfect angle for each application
- Convex mirror provides a wide-angle view wherever needed
- Bright, anodized aluminum construction is lightweight and rust-free
- Includes mirror head and mounting bracket



Front



Back

Part#	Glass Size (W x H)	Finish
604650	7-1/2" x 5-1/2"	Anodized aluminum

LOOK-DOWN CONVEX MIRROR ASSEMBLIES

- Universal design for over-the-door, peek-a-boo or back window applications
- Adjustable design to find the perfect angle for each application
- Convex mirror provides a wide-angle view wherever needed
- Shatterproof glass ideal for agricultural, mining and military applications (#612785)
- Includes mirror head and mounting bracket



610868



612785



Part#	Glass Size (W x H)	Finish
610868	8" x 4"	Polished stainless
612785	10" x 6"	Black ABS plastic

SAFETY MIRROR ASSEMBLIES

- Universal mounts fit a wide variety of heavy-duty applications
- Adjustable design to find the perfect angle for each application
- Convex mirrors help eliminate blind spots for safer maneuvering (select models)
- Compatible with all round and rectangular convex mirrors, starting on page 52
- Most models include mounting assembly only
- Most models made in USA (#604673 and #611922 excluded)
- **See adjacent page for part numbers**



604671



604674



611651



611656



604696



604697



610869



604653

NEW



611922

NEW



604676



604677



604673

SAFETY MIRROR ASSEMBLIES

Part#	Adjustment Range	Application Type	Mount Style	Mirror Included	Glass Diameter	Finish
604671	--	Cabover mount	Bolts onto side mirror assembly	--	--	Polished stainless
604674	12" to 19"	Cowl or fender mount	Bell-type mount	--	--	Polished stainless
611651	12" to 19"	Conventional fender guide mount	L-bracket mount	--	--	Polished stainless
611656	25" to 32"	Conventional fender mount	L-bracket mount	--	--	Polished stainless
604696	14" to 19"	Hood mount	Four-bolt pod mount	--	--	Polished stainless
604697	18" to 23"	Hood mount	Four-bolt pod mount	--	--	Polished stainless
610869	--	Hood mount	Four-bolt pod mount	Yes	8"	Polished stainless
604653	20" to 29"	Fender mount, school bus cross-view	L-bracket mount	--	--	Carbon steel with black powder coat
611922 NEW	18" to 24"	Conventional fender mount	Bell-type mount	--	--	Polished stainless
604676 NEW	18" to 24"	Conventional fender mount	Bell-type mount	Yes	8"	Polished stainless
604677	21" to 34"	Fender mount	Bell-type mount	--	--	Polished stainless
604673	21" to 34"	Fender mount	Bell-type mount	Yes	8"	Polished stainless



REAR-MOUNT SAFETY MIRROR ASSEMBLIES

- Universal design for rear van, straight truck or look-down applications
- Ideal for adding visibility on delivery and emergency vehicles
- Includes mounting assembly only



608135



608100



608137



608102



604698

Part#	Finish	Mount Style
608135	Polished stainless	Four-bolt vertical bracket mount
608100	Polished stainless	Four-bolt horizontal bracket mount
608102	Carbon steel with black powder coat	Four-bolt horizontal bracket mount
608137	Carbon steel with black powder coat	Four-bolt vertical bracket mount
604698	Polished stainless	--



LIGHT-DUTY MIRRORS

CUSTOM-FIT FOR WORK OR PLAY

RETRAC light-duty mirror heads and mirror assemblies are designed to offer a vehicle-specific fit and are the perfect match for the OE mirrors on light-duty trucks. These mirrors range in size and style, mimicking the look of the existing mirror on each application. Many of our light-duty mirrors are made with first-surface glass to eliminate dangerous glare, and many are available with a range of features, including a retractable design.

FEATURED PRODUCTS



Light-duty mirror heads

For light-duty pickups from Chevy, Dodge, Ford, GMC, Ram and more, these mirrors offer the look and functionality of original equipment.



Custom assemblies

These assemblies are designed to be a perfect, vehicle-specific mirror replacement option for light-duty pickup trucks and SUVs.

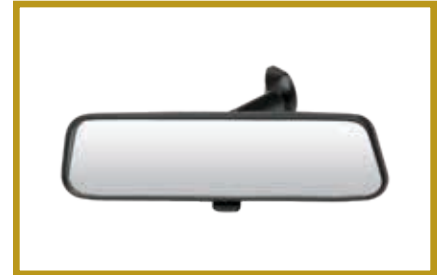

Rear view mirror

This rear view mirror is a reliable replacement, featuring a prismatic ground option to reduce glare for night driving.

PRODUCT INDEX



64
Custom
West Coast
Assemblies



65
Universal
Light-Duty
Assembly



66
Light-Duty
Mirror Heads



66
Universal
Mirror Head
with Gooseneck



67
Junior
West Coast
Mirror Head



67
Rear View
Mirror



CUSTOM WEST COAST MIRROR ASSEMBLIES

- Original equipment, light-duty style to provide a perfect OEM replacement
- No-drill, vehicle-specific design to perfectly match the factory holes
- Patented retractable assembly for added clearance when needed
- Universal stud mounts easily attach the mirror head to the loop
- 7" x 16" flat mirror provides a wide view to help minimize blind spots
- First-surface electro-chrome glass eliminates glare for maximum safety
- Polished stainless steel construction for a bright, rust-free accent
- Includes mirror head, mounting assembly and hardware



611643 front

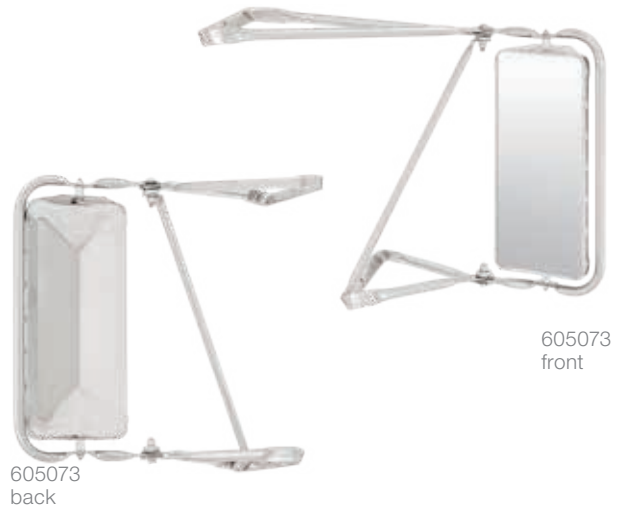

605073 front

Custom Light-Duty West Coast Mirror Assemblies			
Make / Model	Years	Driver-Side#	Passenger-Side#
Chevrolet			
C/K 1500	88 - 98	611642	611643
C/K 1500 Suburban	92 - 99	611642	611643
C/K 2500	88 - 00	611642	611643
C/K 2500 Suburban	92 - 99	611642	611643
C/K 3500	88 - 00	611642	611643
Dodge			
Ram 1500	94 - 01	611642	611643
Ram 2500	94 - 01	611642	611643
Ram 3500	94 - 01	611642	611643

Custom Light-Duty West Coast Mirror Assemblies			
Make / Model	Years	Driver-Side#	Passenger-Side#
Ford			
F-150	80 - 98	605071	605073
F-250	80 - 98	605071	605073
F-350	80 - 97	605071	605073
GMC			
C/K 1500	88 - 99	611642	611643
C/K 1500 Suburban	92 - 99	611642	611643
C/K 2500	88 - 00	611642	611643
C/K 2500 Suburban	92 - 99	611642	611643
C/K 3500	88 - 00	611642	611643



UNIVERSAL LIGHT-DUTY MIRROR ASSEMBLY

- Universal design fits a wide variety of light-duty applications
- 7-1/2" x 10-1/2" flat mirror provides a wide view to help minimize blind spots
- First-surface electro-chrome glass eliminates glare for maximum safety
- Bright, anodized aluminum head is lightweight and rust-free
- Mounting assembly constructed from polished stainless steel
- Includes mirror head, mounting assembly and hardware



Part#	Glass Size (W x H)	Mirror Finish	Assembly Finish	Pivot
611500	7-1/2" x 10-1/2"	Anodized aluminum	Polished stainless	12"

MIRROR EXTENSIONS

- Compatible with universal light-duty mirror #604631 only
- Adds 3" to universal mounting assembly for an extended view (#601690)
- Gooseneck positions mirror for an extended view (#605755)
- Polished stainless steel construction for a bright, rust-free accent



Part#	Description	Finish
601690	3" extension	Polished stainless
605755	Gooseneck extension	Polished stainless



LIGHT-DUTY MIRROR HEADS

- Original equipment, light-duty style to provide a perfect OEM replacement
- Flat glass provides a clear view to help minimize blind spots
- First-surface electro-chrome glass eliminates glare for maximum safety
- Center-mount ball stud for added stability and easy tilt adjustment (#610480, #610485)
- Includes mirror head only (mounting assembly not included)



610480



610485



604775



604775



604768



604769



Part#	Glass Size (W x H)	Finish	Ball Stud
604768	9" x 6"	Polished stainless	--
604769	8" x 5"	Polished stainless	--
604775*	7-1/2" x 5-1/2"	Anodized aluminum	--
610480	5-1/2" x 7-1/2"	Stainless steel	Metal
610485	5-1/2" x 7-1/2"	Anodized aluminum	Metal

* Continued while supplies last



UNIVERSAL LIGHT-DUTY MIRROR HEAD WITH GOOSENECK

- Universal design fits a wide variety of light-duty applications
- 7-1/2" x 10-1/2" flat mirror provides a wide view to help minimize blind spots
- First-surface electro-chrome glass eliminates glare for maximum safety
- Gooseneck positions mirror for an extended view
- Polished stainless steel construction for a bright, rust-free accent
- Includes mirror head and gooseneck only



Front



Back

Part#	Glass Size (W x H)	Finish
611600	7-1/2" x 10-1/2"	Polished stainless



JUNIOR WEST COAST MIRROR HEAD

- Bright, yellow, embossed chevrons add style and visibility to the vehicle
- Universal flange mounts easily attach to all standard loops and swedged loops
- 6" x 12" flat mirror provides a wide view to help minimize blind spots
- First-surface electro-chrome glass eliminates glare for maximum safety
- Stamped aluminum construction to be strong, lightweight and rust-free
- Bright, anodized finish for enhanced corrosion resistance
- Includes mirror head only (mounting assembly not included)



Front

Back

Part#	Glass Size (W x H)	Finish
601331	6" x 12"	Anodized aluminum

REAR VIEW MIRROR

- Day / night prismatic ground glass can be tilted down to dim bright lights
- Black leather-grain vinyl backing provides a stylish interior accent
- 10" wide glass provides a wide view for maximum safety
- First-surface electro-chrome glass eliminates glare for maximum safety
- Stick-on adhesive pad allows for quick, easy installation
- Includes mirror head and mounting bracket with double-sided tape



Front

Back

Part#	Glass Size	Finish
102558	10" width	Black vinyl



STEP VAN MIRRORS

DEPENDABILITY ON THE JOB

For delivery trucks, walk-in vans and other commercial vehicles, RETRAC step van mirrors offer a perfect mirror replacement option. They are designed to mimic the OE look and functionality and are available in a range of colors to match the style of standard delivery trucks, including black, white, polished stainless steel and anodized aluminum. RETRAC step van mirrors are available in vehicle-specific or universal applications, and most feature first-surface, non-glare glass for maximum safety.



FEATURED PRODUCTS



West coast mirror heads

These west-coast-style mirrors come ready to mount onto an existing mirror loop on the van, providing a clear view and OE look.



Convex mirror heads

Our convex mirrors offer a wide-angle view to reduce dangerous blind spots. They are available in multiple finishes.



Custom mirror assemblies

For a complete OE replacement, step van mirrors come in assembly sets, including the mirrors and assemblies for both sides of the van.

PRODUCT INDEX



70
Custom
Step Van Mirror
Assembly Sets



70
Universal
Step Van Mirror
Assembly Set



71
West Coast
Step Van Mirror
Heads



71
Convex
Step Van Mirror
Heads



CUSTOM STEP VAN MIRROR ASSEMBLY SETS

- Original equipment, light-duty style to provide a perfect OEM replacement
- No-drill, vehicle-specific design to perfectly match the factory holes
- Patented retractable assembly for added clearance when needed
- First-surface electro-chrome glass eliminates glare for maximum safety
- Available in multiple finishes to match various step vans
- Includes driver-side and passenger-side mirror heads, assemblies and hardware

Custom Step Van Mirror Assembly Sets		
Make / Model	Standard Stainless Steel	Fedex Dual-Head Stainless Steel
	Long Loop#	Short Loop#
Morgan Olson		
P700	609105	605680
P1200	609105	605680
Union City Body		
P700	609105	605680
P1200	609105	605680
Utilimaster		
P700	--	605680
P1200	--	605680



605680 back



605680 front



UNIVERSAL STEP VAN MIRROR ASSEMBLY SET

- Universal design to fit all models of step vans
- Bright chevrons add style and visibility to the vehicle
- Patented retractable assembly for added clearance when needed
- Mirror adjusts up or down on the loop to fit various window and door sizes
- First-surface electro-chrome glass eliminates glare for maximum safety
- Includes driver-side and passenger-side mirror heads, assemblies and hardware

Part#	Mirror Head Finish	Assembly Finish	Flat Glass Size
604710	Polished stainless	Carbon steel with white powder coat	6" x 16"



604710 back



WEST COAST STEP VAN MIRROR HEADS

- Original equipment, light-duty style to provide a perfect OEM replacement
- Flat mirror provides a wide view to help minimize blind spots
- Clamp mounts securely attach to an existing loop
- First-surface electro-chrome glass eliminates glare for maximum safety
- Available in multiple finishes to match FedEx, USPS and other step vans
- Includes mirror head only (mounting assembly not included)



610827



610829



610840



610848



607972



610809

Part#	Glass Size (W x H)	Finish
Mirror Heads		
610827	6-1/2" x 10"	Carbon steel with white powder coat
610829	6-1/2" x 10"	Polished stainless
610840	6-1/2" x 10"	White ABS plastic
610848	6-1/2" x 10"	Black ABS plastic
610809	7-1/2" x 10-1/2"	Anodized aluminum
Replacement Glass		
607972	6-1/2" x 10"	--



CONVEX STEP VAN MIRROR HEADS

- Original equipment, light-duty style to provide a perfect OEM replacement
- Convex glass helps eliminate blind spots for safer maneuvering
- First-surface electro-chrome glass eliminates glare for maximum safety
- Available in multiple finishes to match FedEx, USPS and other step vans
- Includes mirror head only (mounting assembly not included)



610815



610819



610836



610844



607970



610806

Part#	Glass Size (W x H)	Finish
Mirror Heads		
610815	6-1/2" x 6"	Polished stainless
610819	6-1/2" x 6"	Carbon steel with white powder coat
610836	6-1/2" x 6"	White ABS plastic
610844	6-1/2" x 6"	Black ABS plastic
610806*	7-1/2" x 10-1/2"	Aluminum with black powder coat
Replacement Glass		
607970	6-1/2" x 6"	--

* Continued while supplies last



COMPONENT PARTS

A SECURE MOUNT FOR EVERY TRUCK

Installing a replacement mirror on any truck is easy with RETRAC loops, clamps and brackets. These component parts make it simple to securely attach our heavy-duty or step van mirrors and ensure the perfect fit for each application. Many of these parts are available in multiple finish options and have a versatile design to match each unique truck. We also offer heavy-duty grab handles for a solid handhold when climbing in or out of the truck cab.



MIRROR CLAMPS

- Mounts a west coast mirror head or spot mirror to a standard mirror loop



607965



607956 (shown apart)



607961



607962



607958



607959



607956



612994



612995



612996



607952

Part#	Mount Style	Fits	Stub Hole	Finish
607965	OEM	3/4" O.D. tube	5/16"	Carbon steel with plastic coating
607961	Two-piece dovetail	3/4" O.D. tube	3/8"	Polished stainless
607962	Two-piece dovetail	3/4" O.D. tube	3/8"	Carbon steel with zinc plating
607958	Two-piece dovetail	3/4" O.D. tube	1/4"	Polished stainless
607959	Two-piece dovetail	3/4" O.D. tube	1/4"	Carbon steel with zinc plating
607956	Two-piece dovetail	5/8" O.D. tube	3/8"	Carbon steel with zinc plating
612994	Two-piece dovetail	1" O.D. tube	3/8"	Polished stainless
612995	Two-piece dovetail	1-1/8" O.D. tube	3/8"	Polished stainless
612996	Two-piece dovetail	1-1/4" O.D. tube	3/8"	Polished stainless
607952	Twisted	1/4" hole	1/4"	Polished stainless
607964	GM-style	1/4" hole	5/16" slotted	Carbon steel with plastic coating



607964



MIRROR LOOPS

- Plain-type design to accept west coast mirror heads with clamp mounts
- Swedge-type design to accept RETRAC west coast mirror heads with stud mounts
- A wide variety of sizes available to fit virtually any heavy-duty mirror and assembly
- Available in polished stainless or powder-coated steel in a variety of colors
- Includes loop only (mirror head and other mounting assembly components not included)

Measuring a mirror loop

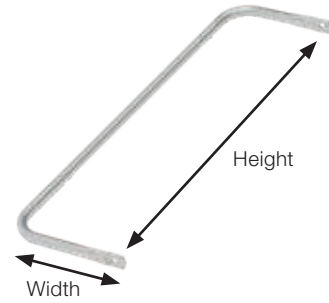

Finish options



Polished stainless

White powder coat

Black powder coat

Grey powder coat

Loop type



Swedge-type



Plain-type

Product photos



601970

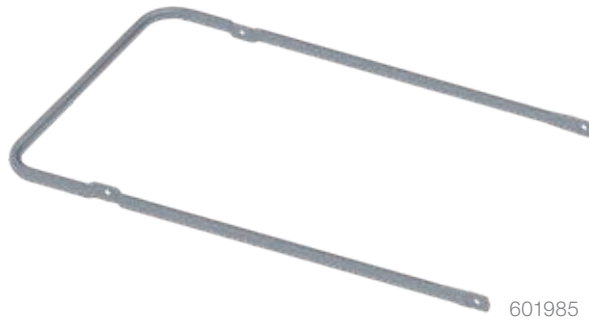

601985



604427



606745



601959



601795



601762



MIRROR LOOPS

Dimensions		Finishes			
Width	Height	Stainless#	White#	Black#	Grey#
Swedge-Type					
8.50"	14.1875"	601950	--	--	--
7.25"	18.00"	--	601959	--	--
8.875"	18.00"	601870	601873	--	601872
12.00"	18.50"	601972	--	--	601970
17.00"	18.50"	608160	--	--	--
30.3125"	18.50"	--	--	--	601985
Plain-Type					
10.50"	12.50"	--	--	601762	--
15.00"	15.25"	606655	--	--	--
8.78"	17.096"	604425	--	604427	--
11.91"	17.096"	612240	--	--	--
9.25"	18.50"	601795	--	--	--
12.00"	18.50"	601885	--	--	--
9.25"	18.50" to 30.50"	602105	--	--	--
5.25"	19.675"	606745	--	--	--
16.50"	20.50"	--	--	604442	--
15.25"	20.675"	604378	--	--	--
8.50"	20.00"	612305*	--	--	--
9.25"	20.00" to 32.00"	602104	602106	--	--
16.375"	21.192"	608185	--	--	--
7.50"	21.75"	601890	--	--	--
5.50"	22.50"	601900	--	--	--
5.75"	23.25"	601905	--	--	--
9.50"	23.25"	601825	--	--	--
10.00"	23.25"	--	601834	--	--
14.00"	23.25"	--	604412	--	--
11.50"	24.50"	601835	601839	--	601838
14.50"	24.50"	601960	--	--	--
8.9375"	25.125"	--	--	606742	--
7.25"	26.25"	601925	--	--	--
7.75"	27.75"	--	--	601912	--
11.50"	28.375"	601829	--	--	--
13.5625"	28.875"	601994	--	--	--
5.75"	29.875"	601920	601924	--	601923
10.00"	30.00"	601860	--	601862	--
20.75"	30.00"	612200	--	--	--
8.81"	30.182"	--	--	--	606789
9.50"	30.50"	--	--	--	--
8.18"	31.8125"	--	612218	--	--
8.81"	31.3125"	--	--	--	--
5.75"	32.75"	601930	--	--	--
7.58"	33.24"	--	--	606737	--
7.25"	34.105"	608225	--	608227	608229
8.81"	35.125"	--	608183	608182	--
10.125"	35.142"	606720	--	--	--
15.50"	36.50"	601935	601939	--	--

*612305 is used for aerodynamic mirror heads



AUXILIARY MIRROR MOUNTING BRACKETS

- Provides a solid mount for an auxiliary mirror
- Standard J-bracket design fits most RETRAC convex mirrors
- Available in polished stainless or grey powder-coated steel



Part#	Stud Hole	Leg Length	Includes	Finish
608351	--	4"	Brace and tube clamp	Polished stainless
608357	--	4"	Brace and tube clamp	Carbon steel with grey powder coat
608359	--	6"	Brace and tube clamp	Polished stainless
608365	--	6"	Brace and tube clamp	Carbon steel with grey powder coat
608361 NEW	3/8"	4"	Brace and tube clamp (608351) with J-bracket (607968)	Polished stainless
608367 NEW	3/8"	6"	Brace and tube clamp (608359), with J-bracket (607968)	Polished stainless



WEST COAST CONVERSION MOUNTING KIT

- Converts a swedge-type loop to a plain-type
- Allows swedged loops to work with a wider variety of west coast mirrors
- Polished stainless steel construction for a bright, rust-free accent



Part#	Finish
604205	Polished stainless



MIRROR J-BRACKETS

- Standard J-bracket design fits most RETRAC convex mirrors
- Available in polished stainless or zinc-plated carbon steel

Part#	Stud Hole	Finish
607969	3/8"	Carbon steel with zinc plating
607968	3/8"	Polished stainless
607967	1/4"	Carbon steel with zinc plating
607966	1/4"	Polished stainless
607978	Slotted	Polished stainless





ADJUSTABLE STABILIZERS AND BRACES

- Helps stabilize mirror head and mounting assembly for reduced vibration
- Adjustable design extends to fit multiple applications
- Polished stainless steel construction for a bright, rust-free accent

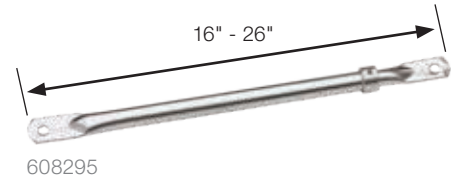
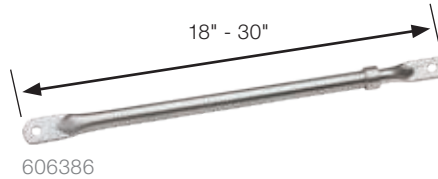
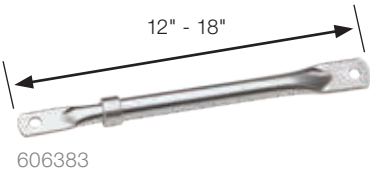
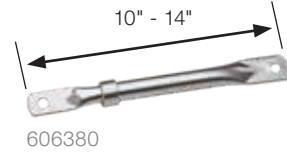
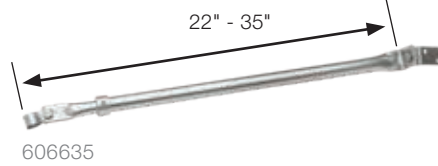
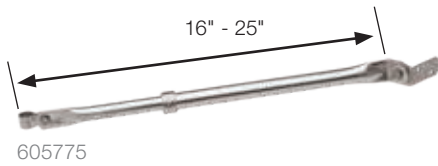

Part#	Mount Style	Retracted Length	Extended Length	Finish
605775	Stabilizer	16"	25"	Polished stainless
606635	Stabilizer	22"	35"	Polished stainless
606380	Brace	10"	14"	Polished stainless
606383	Brace	12"	18"	Polished stainless
606386	Brace	18"	30"	Polished stainless
608295	Brace	16"	26"	Polished stainless



GRAB HANDLES

- Provides a sturdy, 5/8" diameter handle for easier vehicle entry and exit
- Polished stainless steel construction for a bright, rust-free accent
- Includes one grab handle (mounting hardware not included)



Part#	Handle Dimension (End-to-End)	Mounting Hole Dimensions		Finish
		Inside Hole to Inside Hole	Inside Hole to Outside Hole	
602000	11-9/16"	8-11/16" center-to-center	1" center-to-center	Polished stainless
602010	14"	11-1/8" center-to-center	1" center-to-center	Polished stainless
602017	27-1/2"	24-5/8" center-to-center	1" center-to-center	Polished stainless



MARKETING MATERIALS

FULLY SUPPORTING YOUR BUSINESS

We believe in providing our customers with dependable products and ongoing support both in-store and online. For your showroom, we offer signage, display stands and literature to highlight RETRAC products and help your customers make an informed buying decision. For online sales, we offer extensive image, video and content libraries available for your use. To use these resources on your website, please speak to your sales representative.

Contact your sales representative for a complete list of available items and how to qualify.

Literature & Catalog

- Tri-fold literature (8-1/2" x 3-1/2") focuses on educating the consumer about the advantages of RETRAC HD grille guards
- The catalog provides a complete listing of RETRAC products and vehicle applications (#9930003)
- Clear plastic stands available for displaying literature (#99129)



9930004

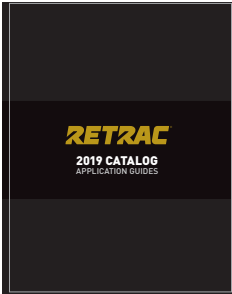

9930003

Banners & Retail Signage

- Attractive signage for use on walls, displays and in-store to help customers identify your RETRAC product offering
- Banner for use in-store and outdoors to help identify and promote your RETRAC offering



9930009 pop-up banner



9930001 banner



9930005 header card

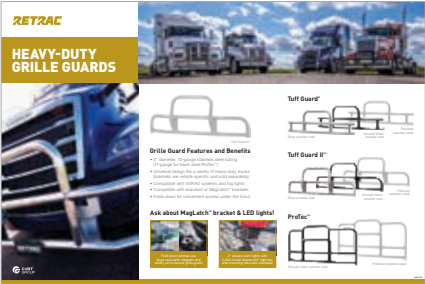

9930007 counter mat

Display Stands & Adapters

- Contact your RETRAC sales representative to determine the product lineup best tailored to meet your needs
- Floor stand display (#9910002) can mount the Tuff Guard® with use of the #9930008 adapter
- Floor stand display (#590710) for mounting the Tuff Guard®
- Counter display (#613004) for mounting mirror heads



9910002 display stand with 9930008 adapter (guard sold separately)



613004



590710 display stand (guard sold separately)



RETRAC

DELIVERING. DEPENDABLE. QUALITY.

For your customers, their truck is their livelihood. It's not just a shiny toy or a status symbol, but it is something they should be proud to own and operate. As such, when it comes to heavy-duty truck accessories, functionality and reliability are of the utmost importance.

Every product your customers buy is an investment in themselves. They expect the same dependability that's required of them every day.

Since 1958, RETRAC has become an industry leader and recognized name for quality mirrors and front-end protection for heavy-duty and medium-duty trucks. We've accomplished this following the same principles your customers use every time they get behind the wheel: functionality and reliability.



Discover other semi truck grill guards on our website.