



***2007-2017 CHEVY SILVERADO 1500-3500 CREW CAB RX3
Includes models equipped with DEF tank***

HARDWARE INCLUDED		RECOMMENDED TOOLS	
1	Passenger Side Front Support Plate		13mm Wrench
1	8-1.25 x 40mm Hex Bolt		13mm Socket
15	8-1.25 x 30mm Hex Bolts		3/8 Torque Wrench
15	8mm Lock Washers		3/8 Ratchet w/3" & 6" extensions
1	8mm x 28mm OD x 3mm Large Flat Washer		
16	8mm x 24mm OD x 2mm STD Flat Washers		
15	8mm U-Nuts		
1	8mm Nylon Lock Nut		

DRIVER-LEFT SIDE INSTALLATION:

STEP 1 - Move vehicle to a level location, (highly recommended for models with DEF tank). Select the driver/left side step with attached (4) full brackets.

STEP 2 - Remove any old steps and hardware. Note certain models may have plastic plugs, (Figure 1), tape or sealant covering mounting holes needed for this installation.

STEP 3 - Start the installation under the driver side of the truck. Locate the (5) tabs with holes, (or welded nuts), along the bottom edge of the body, (Figures 1 & 4). **IMPORTANT:** Installation will use the 1st, 2nd, 4th and 5th mounting tabs only.

Next, locate each upper mounting hole in the inner side of the body directly above the lower mounting tabs. Depending on model year, upper mounting location may be equipped with a large and small hole in the inner body panel, (Figure 1), or a factory 8mm threaded weld nut, (Figures 3 & 4).

Models with hole only in mounting tab and/or inner body panel:

Lower mounting tab with hole - Select (1) 8mm U-Nut. Slide the U-Nut over the 1st tab with the threaded nut facing up behind the tab. Line up the threaded nut with the hole in the tab, (Figures 1 & 2).

Inner body panel with (2) holes - Locate the large and small round holes directly above the mounting tab, (Figure 1). Remove the rubber plug if equipped. Slide (1) 8mm U-Nut into the

larger hole and line up over the smaller hole with the nut facing towards the inside of the body panel, (Figure 2).

Repeat Step 3 to install all necessary 8mm U-Nuts on models/locations without 8mm weld nuts.

STEP 4 - Place the driver/left Side Step in place under the vehicle. Line up the attached brackets with the (4) mounting locations. With assistance, hold the Side Step up to the bottom of the body panel. Attach the lower tabs on the mounting brackets to the bottom of the body first with (4) 8mm x 30mm Hex Bolts, (4) 8mm Lock Washers and (4) 8mm STD Flat Washers, (Figure 5). Do not fully tighten hardware.

STEP 5 - Next, repeat the previous step to bolt the top tabs on the (4) mounting brackets to the inner side of the body panel, (Figure 5).

STEP 6 - Once the Side Step is fully installed, verify the fitment and alignment. Once everything is verified, torque the 8mm hex bolts down to 20ft-lbs.

PASSENGER-RIGHT SIDE INSTALLATION:

STEP 7 - Locate the passenger/right Side Step with (3) full brackets and (1) short front bracket.

STEP 8 - Remove any old steps and hardware. Note certain models will have plastic plugs, (Figure 1), or tape that cover up holes needed for this installation.

STEP 9 - Locate the (5) tabs with holes, (or weld nuts), along the bottom edge of the body, (Figures 1— 4). IMPORTANT: Installation will use the 1st, 2nd, 4th and 5th mounting tabs only. Move to the 2nd, 4th and 5th mounting locations and repeat Step 3 to install the 8mm U-Nuts as needed along the bottom mounting tabs and mounting locations on the inner body panel, (Figure 2).

Step 10 - Move to the passenger side front mounting location. Locate the mounting holes or weld nut in the inner body panel directly above the front mounting tab. On models without factory weld nut, insert an 8mm U-Nut as previously described in Step 3, (Figure 2). IMPORTANT: Do not install a U-Nut on the lower mounting tab on the bottom of the body, (Figure 6).

STEP 11 - Select the passenger side front Support Plate. Attach the Support Plate to the upper mounting location above the front (1st) mounting tab with (1) 8mm x 30mm Hex Bolt, (1) 8mm Lock Washer and (1) 8mm STD Flat Washer, (Figure 6). Do not fully tighten hex bolt at this time.

DIESEL MODELS WITH DEF TANK – It may be necessary or easier to install the passenger front support bracket with the DEF tank lowered for access. Tank does not need to be removed, only lowered to access the upper mounting location on the side of the inner body panel. **IMPORTANT:** Tank may be heavy if full of fluid. Assistance is highly recommended to avoid injury or damage to tank or vehicle.

STEP A – release the tank filler hose and wiring connector. Remove the plastic tray under the tank if equipped.

STEP B – Place jack or suitable stands under tank. **IMPORTANT:** Only use stands or jack with smooth, large flat surface to protect the plastic tank from damage. Remove the (2) tank straps and lower tank until the top of the tank is visible.

Step 12 - Place the passenger/right Side Step in place under the vehicle. Line up the (4) mounting brackets with the mounting locations. First, attach the side step to the 2nd, 4th and 5th mounting tabs on the bottom of the body with (3) 8mm x 30mm Hex Bolts, (3) 8mm Lock Washers and (3) 8mm STD Flat Washers, **(Figure 5)**. Next, attach the top of the (3) mounting brackets to the upper mounting locations on the body panel with (3) 8mm x 30mm Hex Bolts, (3) 8mm Lock Washers and (3) 8mm STD Flat Washers. Leave all hardware loose at this time.

STEP 13 - Return to the passenger side front mounting location. Line up the short front bracket on the Side Step with the mounting tab on the bottom of the body panel. Line up the inner Support Bracket with the Side Step mounting bracket. Bolt the Side Step bracket to the Support Bracket with (1) 8mm x 40mm Long Hex Bolt, (1) 8mm STD Flat Washer (bottom), (1) 8mm Large Flat Washer (top against Support Bracket) and (1) 8mm Nylon Lock Nut, **(Figure 7)**. **NOTE:** On models with weld nut on mounting tab, insert 8mm Hex Bolt with (1) 8mm STD Flat Washer up and through the bracket then the weld nut, **(Figure 8)**. Tighten the Hex Bolt then use (1) 8mm Large Flat washer and 8mm Nylon Lock nut to secure the inner Support Bracket to the mounting bracket on the Side Step, **(Figures 7—9)**.

STEP 14 - Once the Side Step is installed and the bolts are hand tight, verify the fitment and alignment. Once everything is verified, torque the hex bolts to 20ft-lbs.

STEP 15 - Reinstall DEF tank if equipped as described in Step 11.

Periodically check installation and re-torque all fasters to specifications.

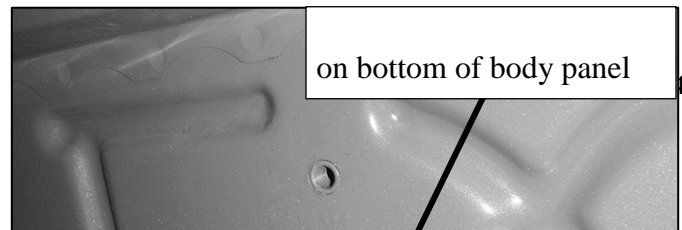
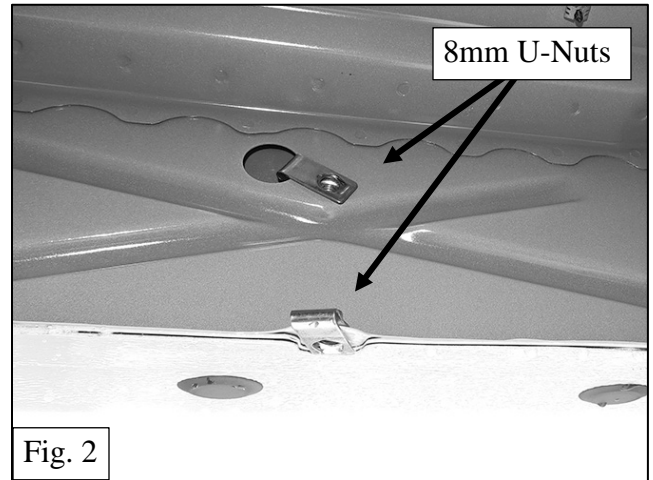
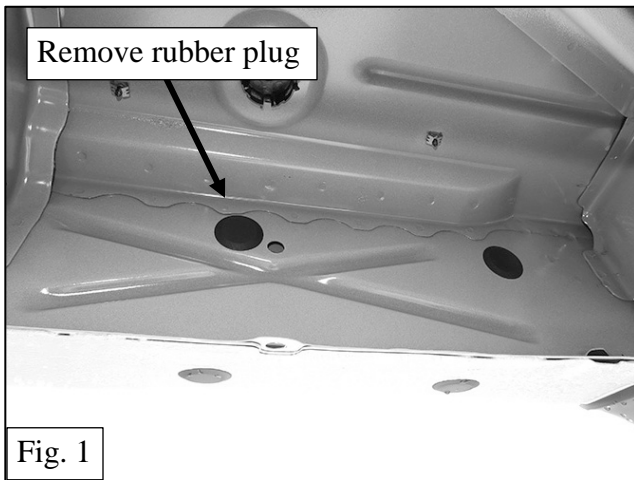

Factory threaded weld nut

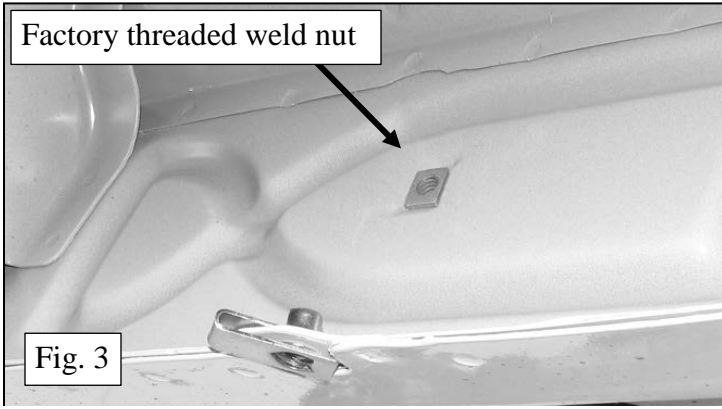

Fig. 3

RBP-1126B--RX3
RBP-1126SS-RX3

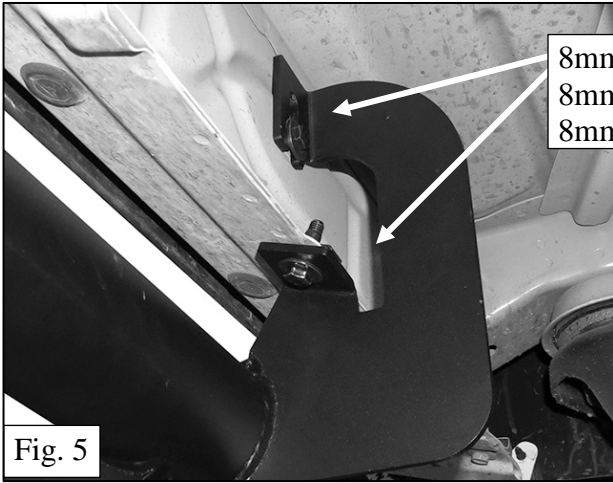
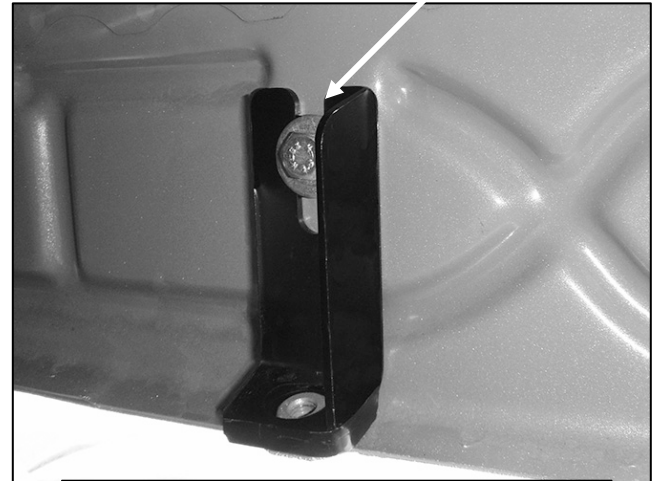

Fig. 5

8mm x 30mm Hex Bolt
8mm Lock Washer
8mm STD Flat Washer

8mm x 30mm Hex Bolt
8mm Lock Washer
8mm STD Flat Washer



(Fig. 6) Passenger front Support Bracket

8mm x 40mm Long Hex Bolt
(1) 8mm STD Flat Washer (bottom)
(1) 8mm Large Flat Washer (top)
8mm Nylon Lock Nut



8mm x 30mm Hex Bolt
8mm Lock Washer
8mm STD Flat Washer

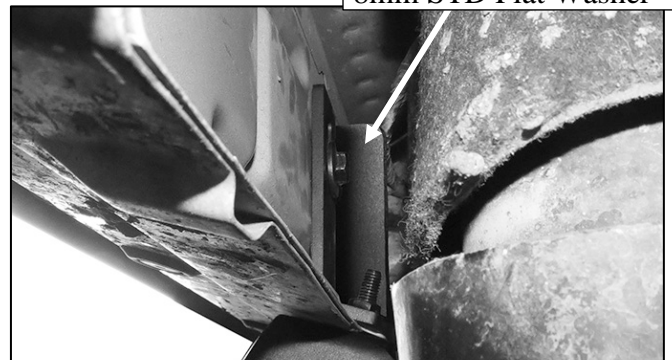

DEF tank

(Fig. 7) Passenger front bracket pictured

Fig. 8

- 8mm x 40mm Long Hex Bolt
- 8mm x 24mm STD Flat Washer (bottom)
- 8mm x 28mm Large Flat Washer (top)
- 8mm Nylon Lock Nut

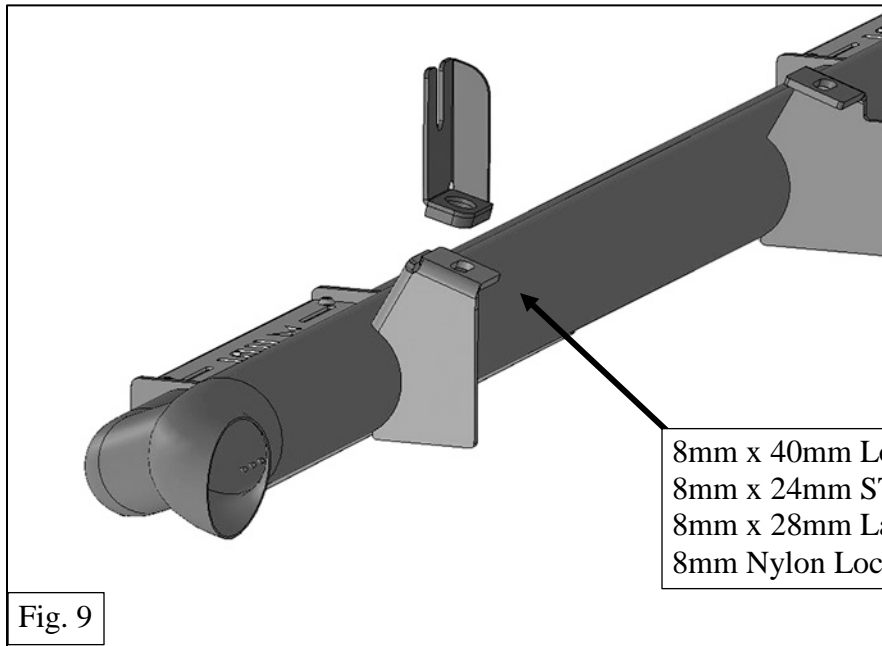

Fig. 9

- 8mm x 40mm Long Hex Bolt
- 8mm x 24mm STD Flat Washer (bottom)
- 8mm x 28mm Large Flat Washer (top)
- 8mm Nylon Lock Nut