

0701-0312, 0701-0312B

4" OVAL BAR

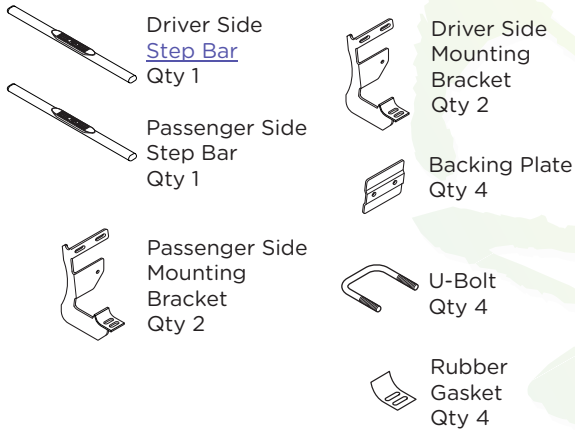

Components:



Hardware:

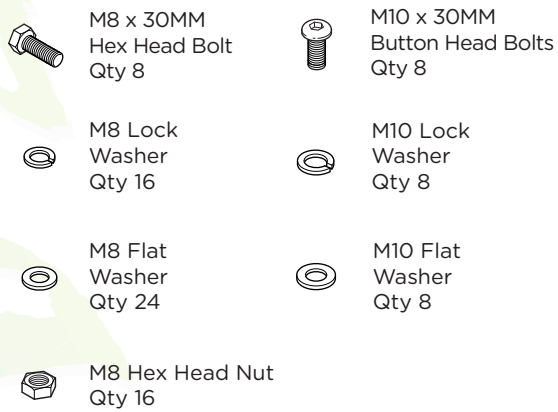

Tools Required:

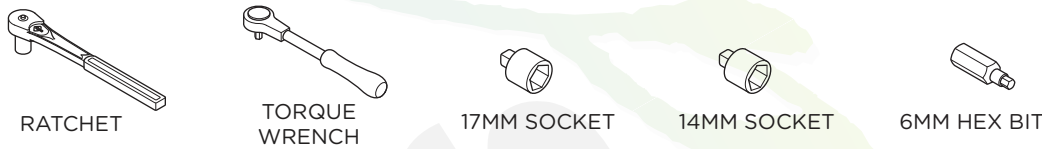

Torque Specifications:

For Rocker Panel Mount Installations
M8 through M12 bolts and nuts are set to 15-20 ft lbs.

Note: When installing the brackets and bars, all hardware must be left loose until all the items are attached.

1. Remove all contents from the package and check stainless steel tubes for any damage. Also, verify that all components and hardware listed above are included before you begin installation.

2. Read installation manual and installation drawing completely. Understand all brackets and bolts before installation.

3. Begin installation on the passenger's side.

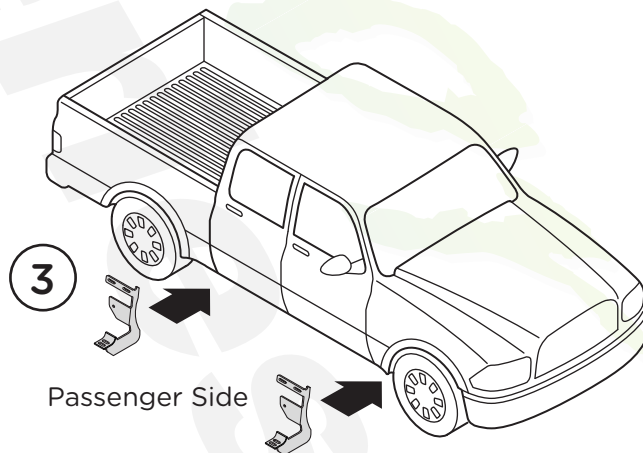

4. Insert the M8 Hex Head Nut on the longer end of U-Bolt.
5. Insert the U-Bolt through the first hole and out through the second hole.

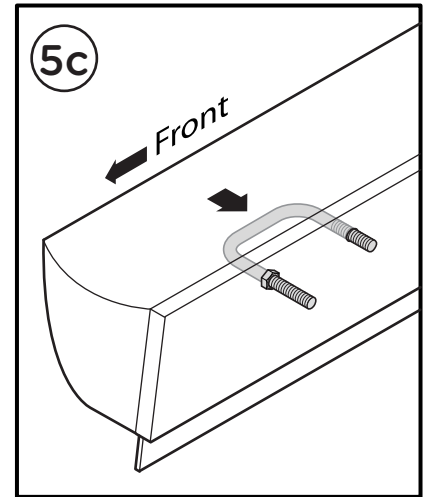
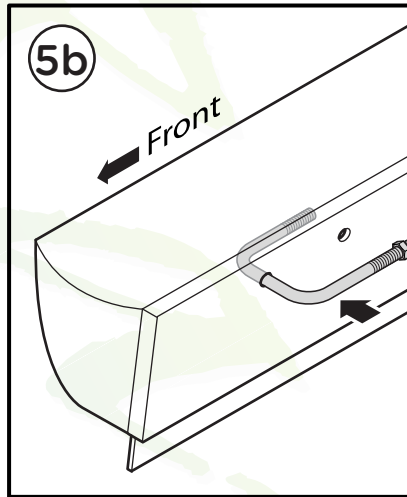
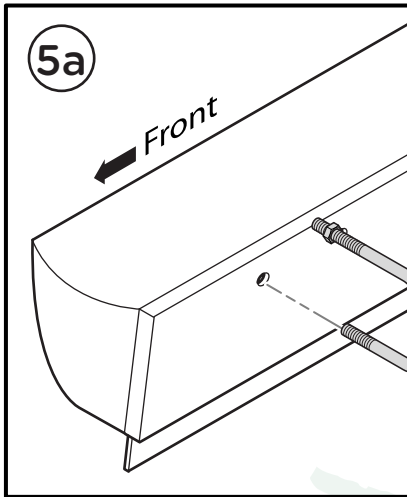
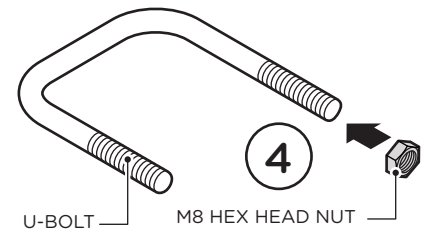

6. Position the Top Flange of the bracket onto the longer end of the U-Bolt. Secure the Mounting Bracket to the U-Bolt using two (2) M8 Hex Head Bolts, two (2) M8 Flat Washers, two (2) M8 Lock Washers and two (2) M8 Hex Head Nuts as shown and leave loose.

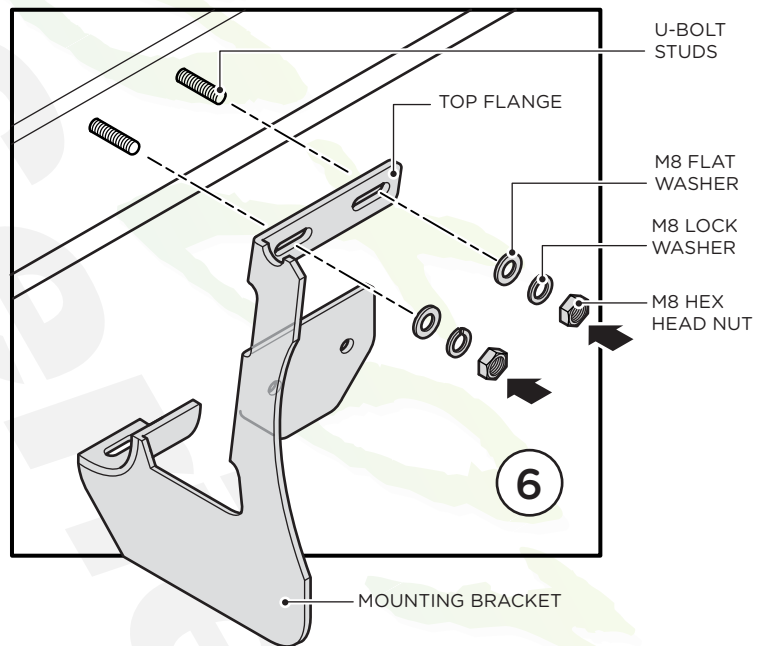

7. Secure the Backing Plate to the Mounting Bracket using two (2) M8 X 30MM Hex Head Bolts, four (4) M8 Flat Washers, two (2) M8 Lock Washers and two (2) M8 Hex Head Nuts as shown and leave loose. The Backing Plate will clamp the Mounting Bracket and pinch weld together. Repeat this steps 4 through 7 for the Rear Bracket.

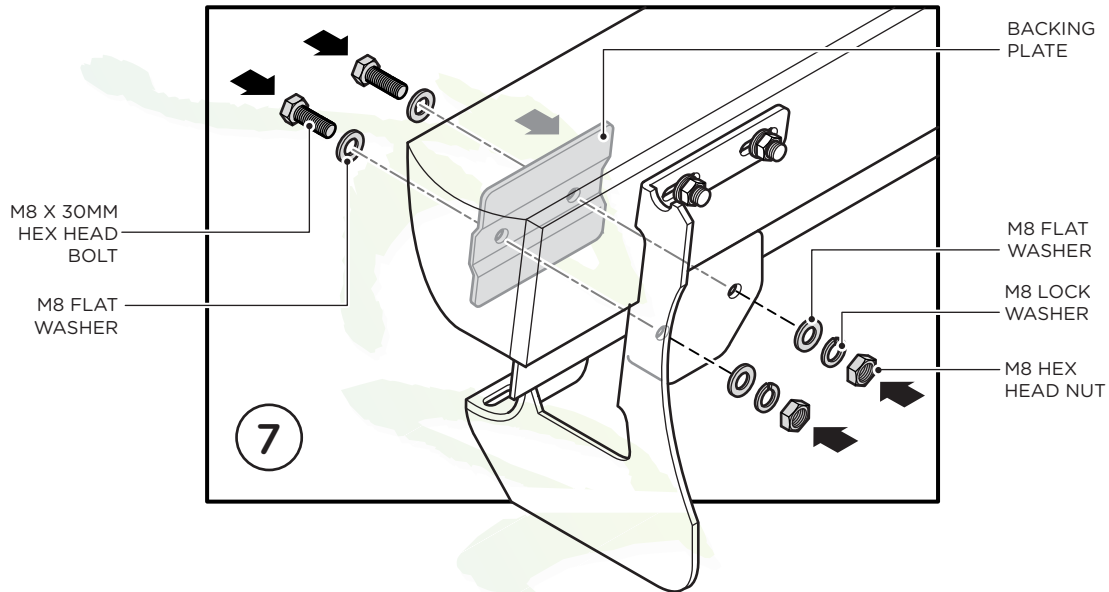

8. Place the Rubber Gaskets onto each bracket. Then, place the Step Bar onto the Brackets. Each Step Bar is marked Driver and Passenger.

9. Secure the Step Bar to each Bracket using two (2) M10 x 30MM Hex Head Bolts and two (2) M10 Lock Washer and two (2) M10 Flat Washers per bracket.

Tighten until the split lock washer is flat against bracket and snug. DO NOT over tighten and strip the threaded insert in the tube.

Repeat these steps for driver side installation. When all hardware is in place, everything must be tightened. See Page 1 for Torque Specifications.

