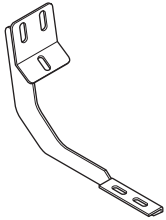
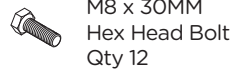
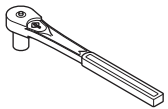
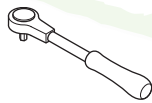

1907-0478BT

5" TREAD STEP*Raptor*
Series**Components:**Mounting Brackets
Qty 6**Hardware:**M8 x 30MM
Hex Head Bolt
Qty 12M8 Flat
Washer
Qty 24M8
Flange Nut
Qty 6M8 Lock
Washer
Qty 24**Tools Required:**

RATCHET

TORQUE
WRENCH

14MM SOCKET

Torque Specifications:

For Rocker Panel Mount Installations
M8 through M12 bolts and nuts are set to 15-20 ft lbs.

Note: When installing the brackets and bars, all hardware must be left loose until all the items are attached.

1. Remove all contents from the package and check stainless steel tubes for any damage. Also, verify that all components and hardware listed above are included before you begin installation.

2. Read installation manual and installation drawing completely. Understand all brackets and bolts before installation.

3. Begin installation on the driver's side. Align **Brackets** as shown.

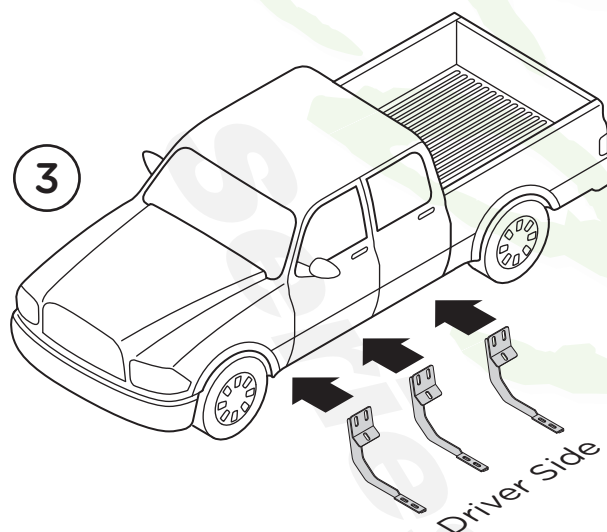

4. Align the Front, Center and Rear Driver's Side Brackets with the existing bolt and existing hole located on the Rocker Panel.

5. Secure the Front, Center and Rear Driver's Side Brackets to the existing Bolt on the Rocker Panel using one (1) M8 Flange Nut. Then fasten using one (1) M8 x 30MM Hex Head Bolt, one (1) M8 Lock Washer and one (1) M8 Flat Washer.

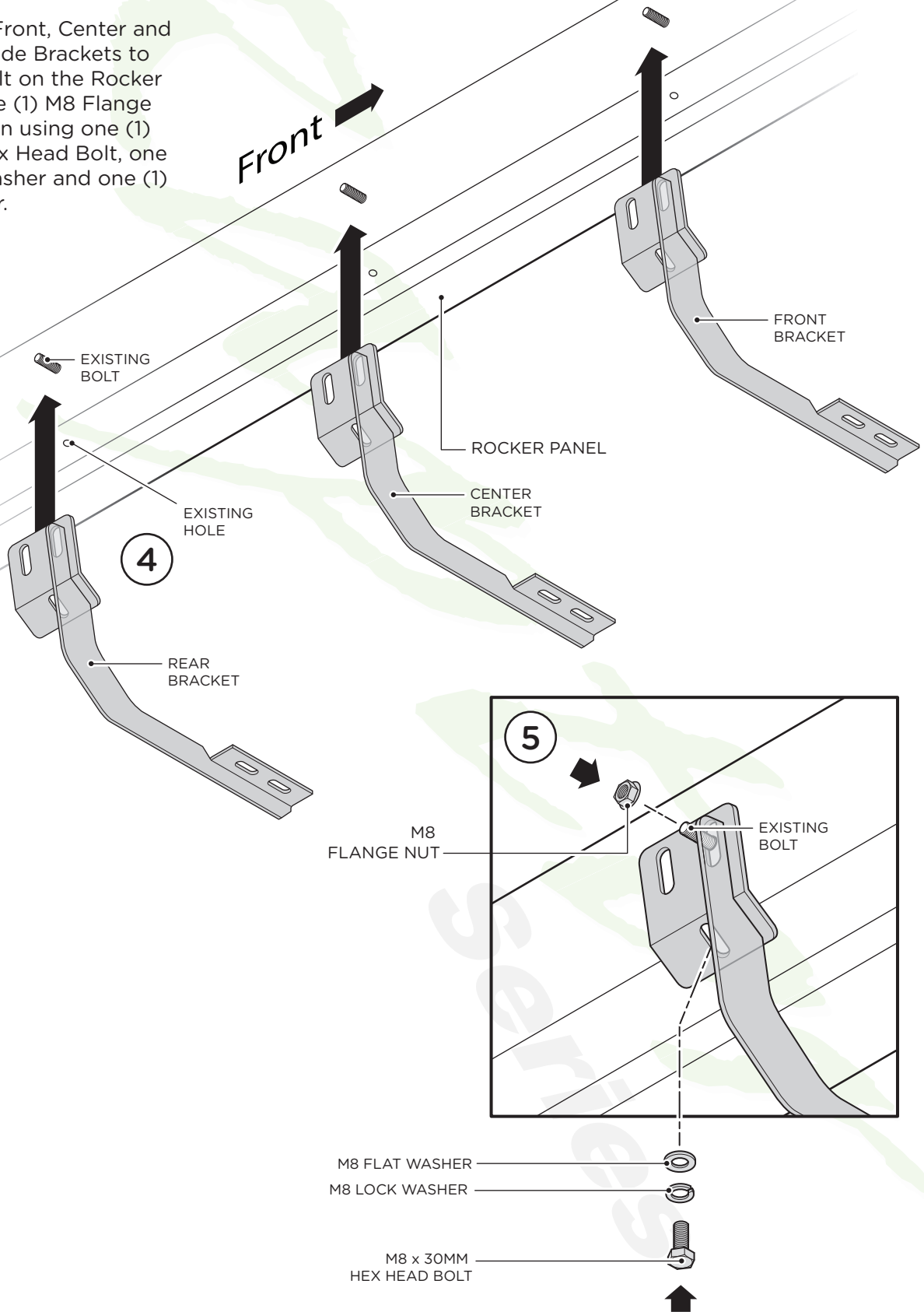

For 2016-Current Body Style

6. Align the Front, Center and Rear Driver's Side Brackets with the two (2) existing holes located on the Rocker Panel (6a).

Fasten using two (2) M8 x 30MM Hex Head Bolts, two (2) M8 Lock Washers and two (2) M8 Flat Washers (6b).

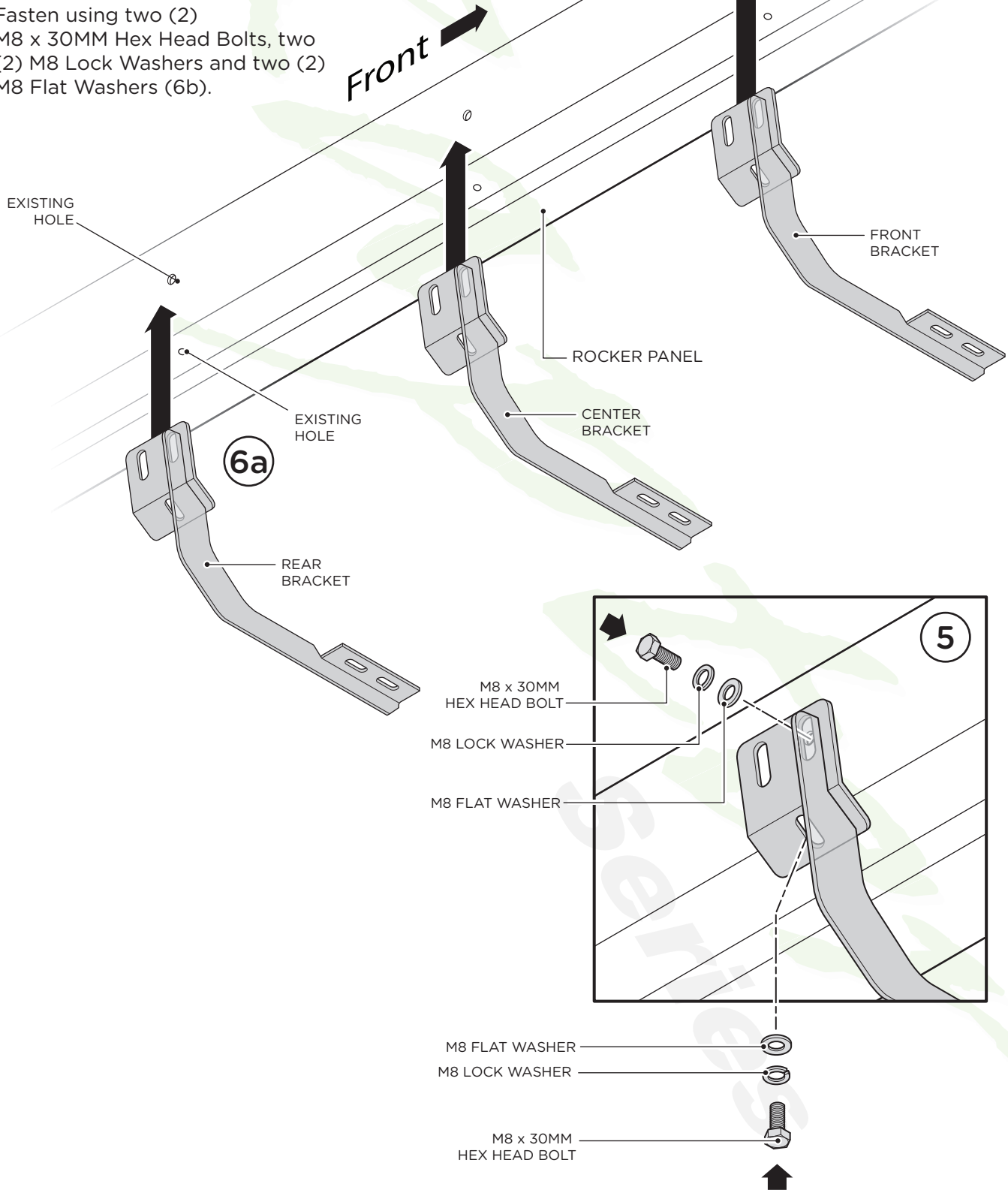

5" TREAD STEP

Raptor
Series

1. Place Running Board on brackets. Each running board is marked Driver and Passenger.

2. Slide M8 threaded studs in track system on the bottom of the Running Board to line up to mounting holes in each bracket.

3. Fasten Running Board on each bracket by using two (2) M8 Flat Washers, two (2) M8 Lock Washers and two (2) M8 Hex Head Nuts per bracket.

When all hardware is in place, everything must be tightened. Tighten until the split lock washer is flat between the M8 Flat Washer and M8 Hex Head Nut.

Repeat these steps for driver side installation.

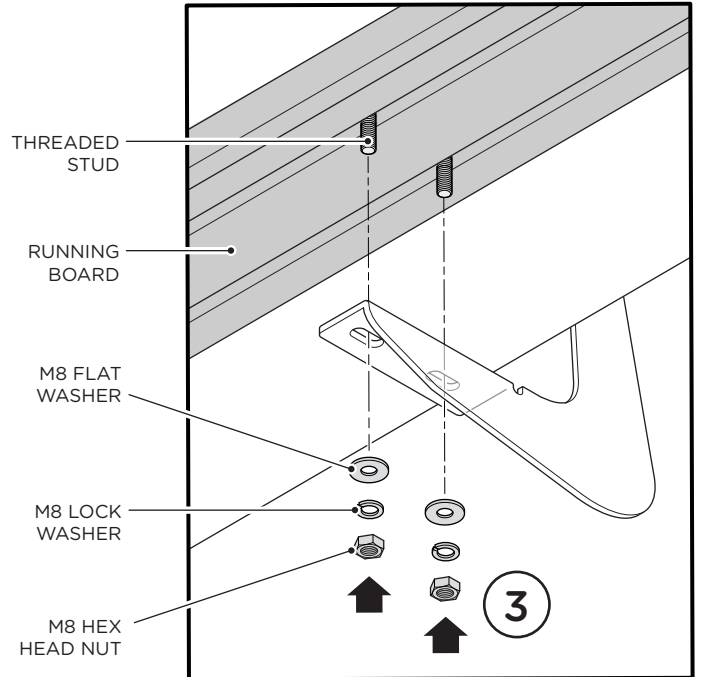

1

