

Raptor **Series**



CAUTION: Do not install damaged parts!!!

Raptor Series

Easy Return / Easy Exchange

Want to return an item or exchange? Not satisfied with purchase?

No problem. We strongly believe in service after the sale and we stand behind our products and our service to you, our valued customer. There is no problem we can't solve for you!

Items that have been installed and/or damaged after receipt, are no longer in new and ready-to-sell condition and cannot be refunded, replaced or exchanged unless it has a manufacturer defect or was damaged in shipping. In addition, we cannot accept return on items that are not in the original packaging. Items returned in poor condition or having parts missing will not be credited.

Please note: Your request for return or replacement must be initiated within 30 days of delivery of your merchandise.

Did your order arrive damaged?

Please do not install damaged products. Contact the company you purchased your product from as soon as possible and notify them of the damages. They will make arrangements with you to assist with the problem.

Did you order the wrong part or receive the wrong item?

Don't worry. From time to time human error can result in problems with ordering or shipping. Contact the company you purchased your product from as soon as you notice the error. Every company has their own policy on returning parts that have been ordered incorrectly or shipped incorrectly.

1702-0501, 1702-0501BT

6" OEM RUNNING BOARD



Components:

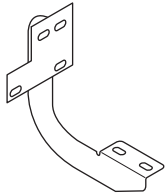

Driver Side Bracket
Qty 3

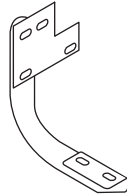

Passenger Side Front/Center Bracket
Qty 2

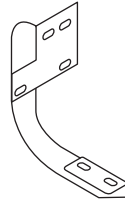

Passenger Side Rear Bracket
Qty 1

Hardware:



M8 Flat Washers
Qty 30



M8 Lock Washers
Qty 30



M8 Hex Head Nuts
Qty 30

Tools Required:

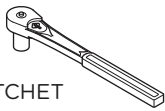

RATCHET



TORQUE WRENCH



13MM SOCKET

Torque Specifications:

For Rocker Panel Mount Installations

M8 through M12 bolts and nuts are set to 15-20 ft lbs.

Note: When installing the brackets and bars, all hardware must be left loose until all the items are attached.

1. Remove all contents from the package and check running boards for any damage. Also, verify that all components and hardware listed above are included before you begin installation.

Begin on driver side of vehicle.

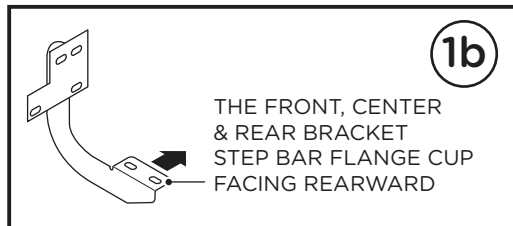
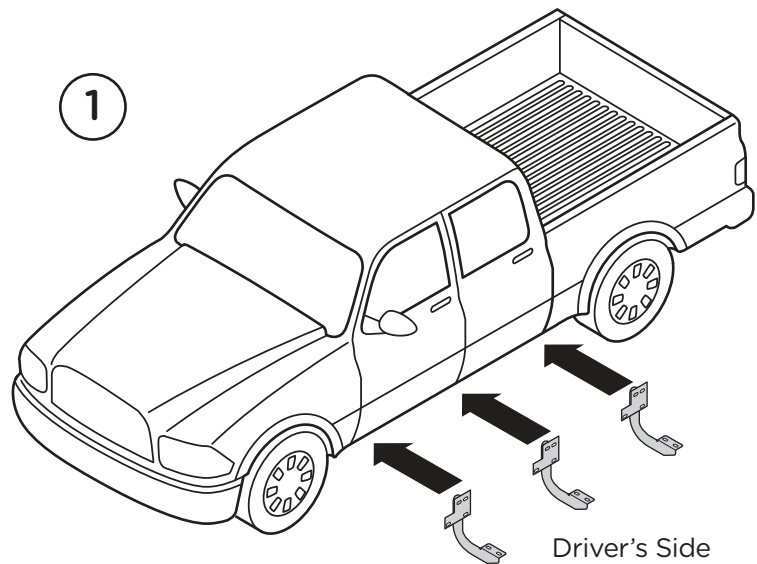

2. Existing mounting studs are located on the interior wall of the rocker panel. These mounting studs will be used for the following instruction

3. On the driver side of the vehicle, align the Front, Center and Rear brackets as shown.

Place each bracket onto the existing mounting studs on the rocker panel.

Fasten by using three (3) M8 Flat Washers, three (3) M8 Lock Washers and three (3) M8 Hex Head Nuts per bracket.

When all hardware is in place, everything must be tightened. See page 1 for torque specifications.

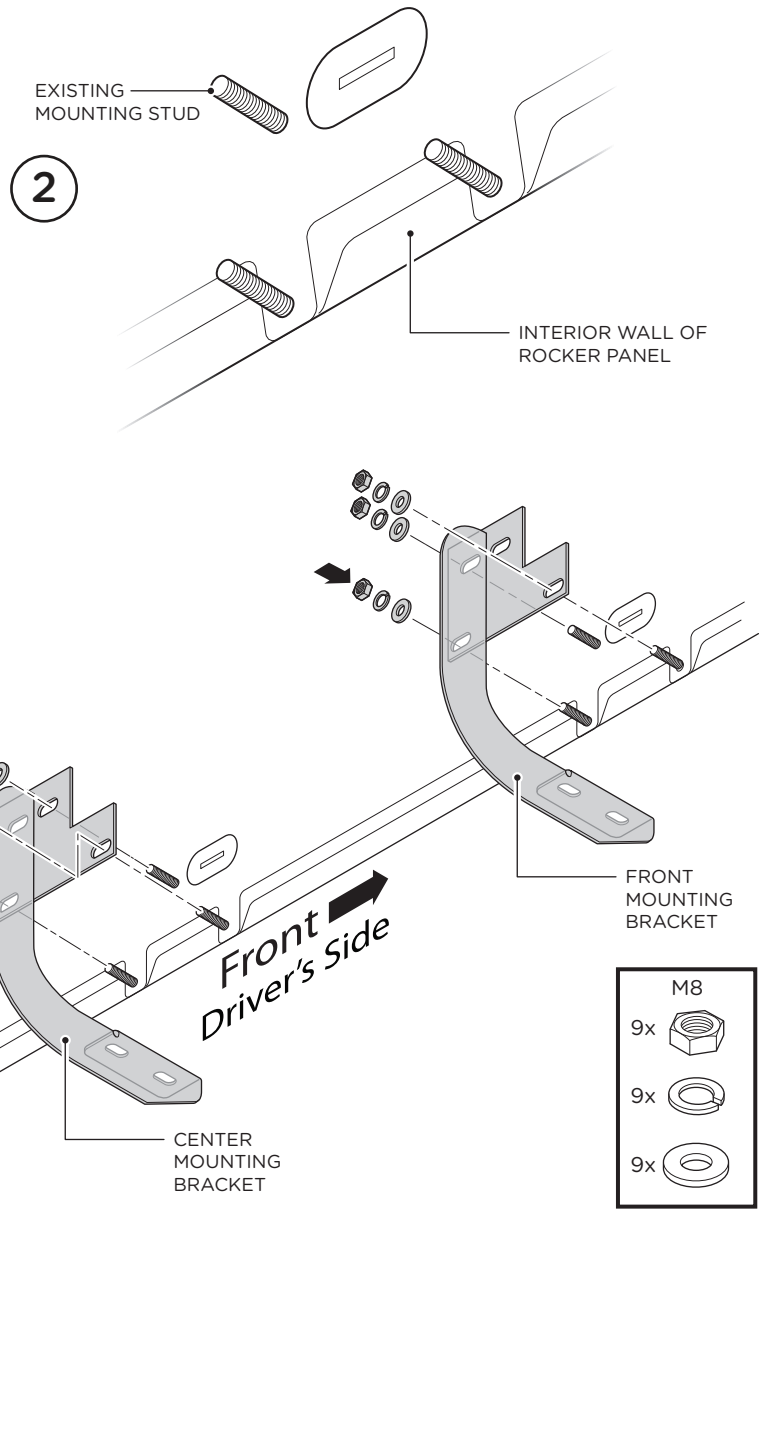

4. On the passenger side of the vehicle, align the Front, Center and Rear brackets as shown.

Place each bracket onto the existing mounting studs on the rocker panel.

Fasten by using three (3) M8 Flat Washers, three (3) M8 Lock Washers and three (3) M8 Hex Head Nuts per bracket.

5. When all hardware is in place, everything must be tightened. See page 1 for torque specifications.

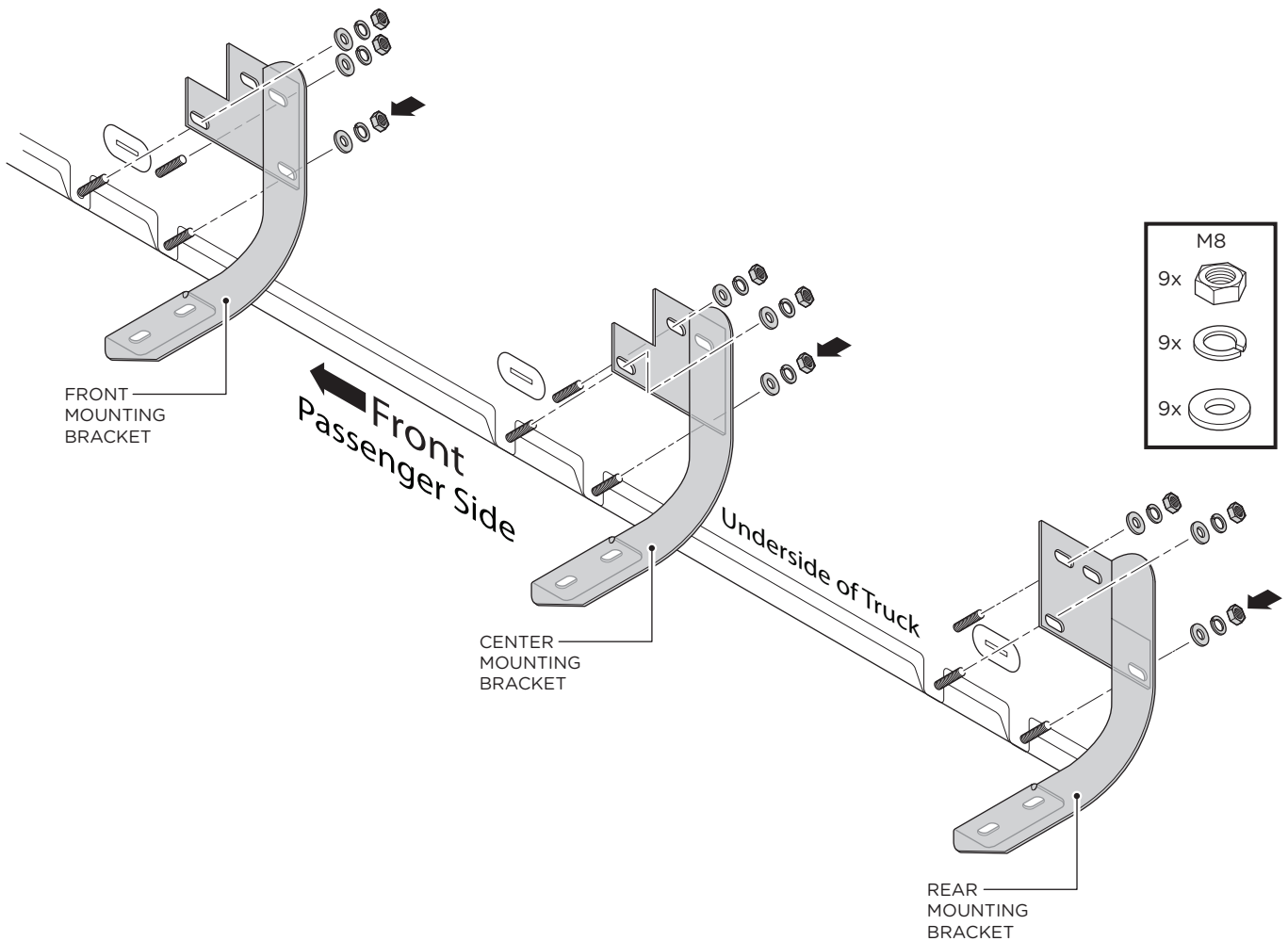

6. Place Running Board on brackets. Each running board is marked Driver and Passenger.

7. Slide M8 threaded studs in track system on the bottom of the Running Board to line up to mounting holes in each bracket.

8. Fasten Running Board on each bracket by using two (2) M8 Flat Washers, two (2) M8 Lock Washers and two (2) M8 Hex Head Nuts per bracket.

When all hardware is in place, everything must be tightened. Tighten until the split lock washer is flat between the M8 Flat Washer and M8 Hex Head Nut.

Repeat these steps for passenger side installation.

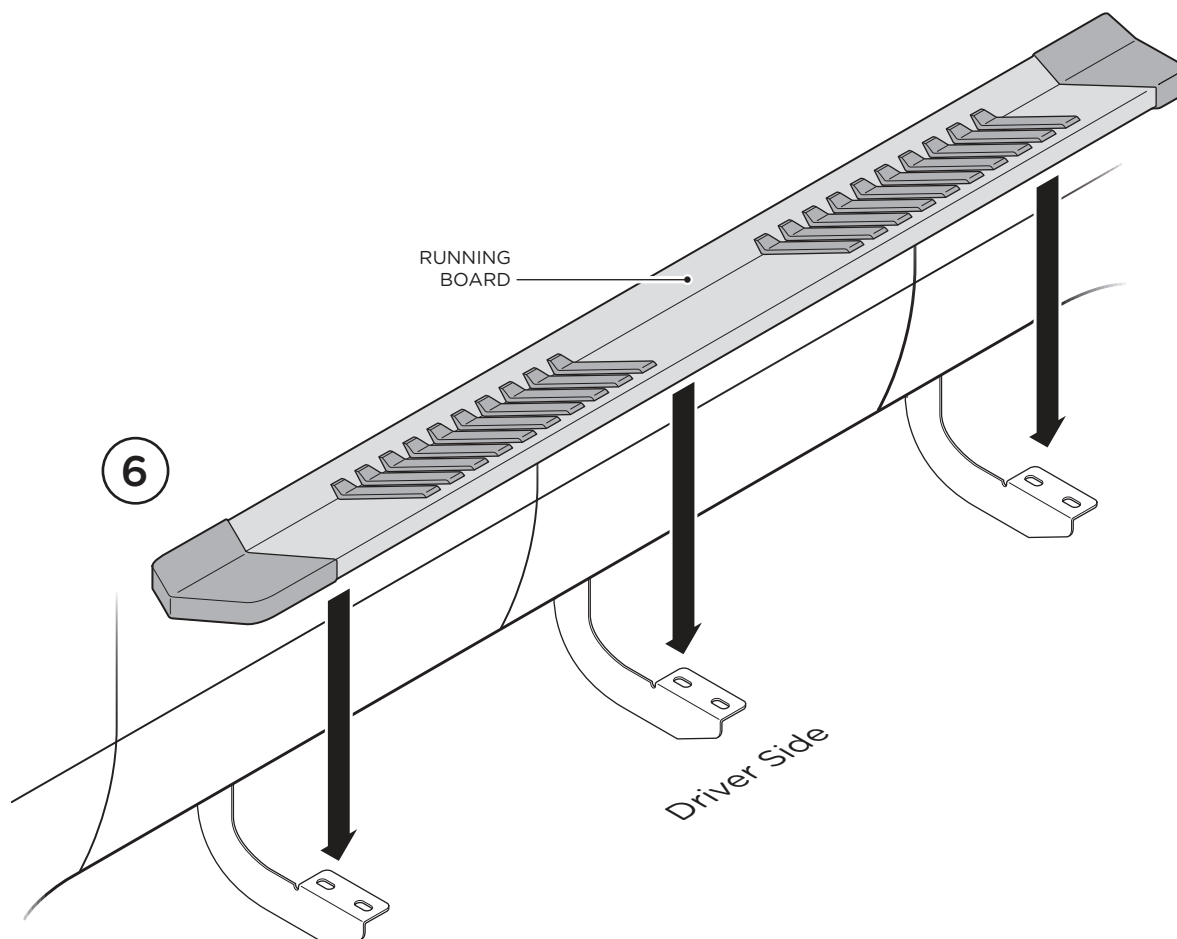
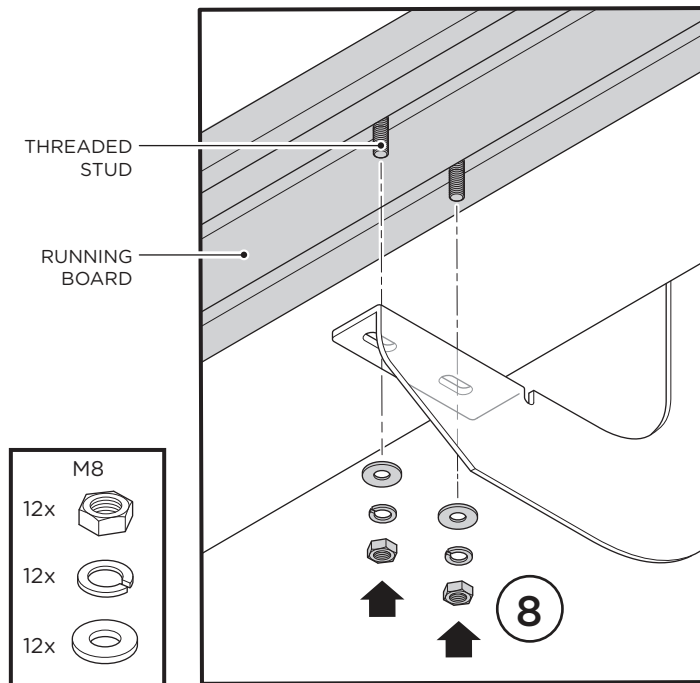

1702-0501, 1702-0501BT

Check out the collection of running boards and step bars we offer.