

INSTALLATION INSTRUCTIONS

89451 Rev B



For Rancho **Suspension Systems**: RS66451R9
2.5" Leveling Kit - "DIESEL MODELS ONLY"

2014 Dodge Ram 2500 4WD
— FMVSS 126 Certified —



Fits OE rims and spare

Fits up to:
BFG KM2 35X12.5R17 Tires
On 17 x 9 x 5.5 Backspacing Wheel

WARNING

Carefully read, understand and follow the instructions provided in this manual, and keep it in a safe place for future reference. If you have any doubt whatsoever regarding the installation or maintenance of your Rancho suspension system, please see your retailer for assistance or advice. Failure to follow the warnings and instructions provided herein can result in the failure of the suspension system, or can cause you to lose control of your vehicle, resulting in an accident, severe personal injury or death.

These instructions should remain in the vehicle glove box for future reference.

 **WARNING: READ ALL INSTRUCTIONS THOROUGHLY FROM START TO FINISH BEFORE BEGINNING INSTALLATION. Failure to follow the warnings and instructions provided herein can result in an accident, severe personal injury or death.**

PRELIMINARY

This manual presumes that all persons installing this suspension system have a high level of mechanical training and experience, and have available to them all necessary tools and safety equipment. This manual is not and should not be construed as an exhaustive list of all required safety measures. Personnel should rely primarily on their training and experience, as well as on their own common sense.

This Manual is to be read as a supplement to, and must not be construed as a substitute for, the owner's manual and/or shop manual that originally accompanied the vehicle. Refer to such use, operation, maintenance and safety manuals as necessary, and especially after installation is complete, to insure proper vehicle operation.

The following terminology has been used in this Manual:

- I. **ACCIDENT:** Any event which could cause personal injury or death to anyone installing or using the suspension system, as well as to passengers and bystanders, or otherwise may result in property damage.

PRE-INSTALLATION WARNINGS and INSTRUCTIONS

 **WARNING: Only the following rim/tire sizes may be used with this suspension system: 35X12.5R17 tire, 17 x 9 x 5.5 Backspacing rim.**

Use of any other rim/tire combination increases the risk of a roll-over and/or accident, resulting in severe personal injury or death.

 **WARNING: This suspension system will enhance the off-road performance of your vehicle. It will handle differently; both on and off-road, from a factory equipped passenger car or truck. Failure to drive this vehicle safely may result in serious injury or death to the driver and passengers. ALWAYS WEAR your seat belts, REDUCE your speed, and AVOID sharp turns and other abrupt maneuvers.**

1) Service and repair tasks require specialized knowledge, training, tools, and experience. General mechanical aptitude may not be sufficient to properly install this suspension system. If you have any doubt whatsoever regarding your ability to properly install the suspension system, please consult a qualified mechanic.

2) Your brake lines and fuel lines should remain undisturbed during and after installation. If you think you need to modify these components in any way, you are mistaken. You are installing the lift improperly and will be creating a significant risk of an accident. In case of any doubt, consult a qualified mechanic.

3) If any component does not fit properly, something is wrong. You are installing the lift kit improperly and will be creating a significant risk of an accident. Never modify any component of the vehicle or suspension system, except as instructed herein. Do not continue with installation until you have identified the problem.

4) Several of the procedures described herein require at least two (2) persons to safely complete the task. If you have any doubt about your ability to complete any operation by yourself, always ask for help from a qualified assistant.

5) Before starting any operation, confirm that all personal safety devices and safety equipment are in proper condition and position.

6) Give your work undivided attention. Looking around, carrying on a conversation and "horse-play" are careless acts that can result in an error in installation and/or serious injury.

7) Install only tires approved by the United States Department of Transportation ("DOT approved"). Make sure the rim and tire size are properly matched.

8) If any components of the vehicle or suspension system are damaged in any way during installation, immediately replace the component.

9) During installation, carefully inspect all parts of the vehicle and replace anything that is worn or damaged.

10) Nip points present the risk of the catching, lacerating, crushing and/or amputating fingers, hands, limbs and other body parts during operations. Always keep clear. Wear protective gloves.

11) Oil and hydraulic fluids are poisonous, dangerous to health and are known to the State of California to cause cancer, birth defects or other reproductive harm. Do not inhale vapors or swallow. Do not allow contact with the eyes or skin. Should any oil or fluids be swallowed or inhaled or come into contact with the eyes, immediately follow the safety precautions on the label or call a poison control center immediately. Should any of the oil or fluids contact your skin, immediately wash thoroughly.

12) Never install the suspension system if you are under the effects of alcohol, medications and/or drugs. If you are taking prescription or over the counter medication, you must consult a medical professional regarding any side effects of the medication that could hinder your ability to work safely.

WARNINGS AND INSTRUCTIONS AFTER INSTALLATION

13) After installation is complete, drive the vehicle slowly in an area free from heavy traffic for at least three (3) miles. Likewise, before traveling on any highways or at a high rate of speed, drive the vehicle for ten (ten) miles on side roads at moderate speed. If you hear any strange noise or feel unusual vibration, if a component of the suspension system is not operating properly, or if any warning lights illuminate or buzzers sound, stop the vehicle immediately. Identify the cause and take any necessary remedial action.

14) Confirm that all components of the vehicle, including all lights (headlights, turn signals, brake lights, etc.), linkages (accelerator, etc.), electrical switches and controls (windshield wipers and defoggers, etc.), and other warning devices (low tire pressure monitoring systems) are fully operational.

15) Your headlights will need to be readjusted before the vehicle is used on the roads. Consult the vehicle owners' manual.

16) The speedometer and odometer will need to be recalibrated after installation. See your dealer.

17) Confirm proper rear view and side view while seated in the driver seat. Install supplemental mirrors as necessary.

18) Your original low tire pressure monitoring system may be re-installed in your new wheels. However, if you choose to purchase a new system, see your dealer to have them properly calibrated. Proper tire pressure is critical to safe operation of the vehicle.

OPERATION

19) Because it has been modified, the vehicle will not handle, turn, accelerate or stop in the same manner as an unmodified vehicle. In addition, the crash protection systems designed in the vehicle may operate differently from an unmodified vehicle. For example, turning and evasive maneuvers must be executed at a slower rate of speed. Further, there is a greater risk that the vehicle could roll over. These differences could result in an increased possibility of an accident, personal injury or death. Learn the vehicle's operations and handling characterizes and drive accordantly.

IMPORTANT NOTES

A. Before installing this system, have the vehicle's alignment and frame checked by a certified technician. The alignment must be within factory specifications and the frame of the vehicle must be sound (no cracks, damage or corrosion).

B. The components of Rancho's suspension system are designed as a single integrated system. To avoid compromises in terms of safety, performance, durability or function, do not substitute Rancho components with components manufactured by other companies. Use of other components will result in the forfeiture of any type of warranty on the vehicle/suspension system.

New Rancho shock absorbers are required on the front and must be purchased separately.

Front	Rear
RS999044	RS999044
RS7044	RS7044
RS5044	RS5044
	OE

C. Do not powder-coat or plate any of the components in this system. To change the appearance of components, automotive paint can be applied over the original coating.

D. Each hardware kit in this system contains fasteners of high strength and specific size. Do not mix hardware kits or substitute a fastener of lesser strength. See bolt identification table on page 4.

E. Compare the contents of this system with the parts list in these instructions.

F. Install all nuts and bolts with a flat washer. When both SAE (small OD) and USS (large OD) washers are used in a fastener assembly, place the USS washer against the slotted hole and the SAE washer against the round hole.

G. Apply a drop of thread locking compound to all bolts during installation.  **CAUTION: Thread locking compound may irritate sensitive skin. Read warning label on container before use.**

H. Unless otherwise specified, tighten all nuts and bolts to the standard torque specifications shown in the table on page 2. USE A TORQUE WRENCH for accurate measurements.

I. Some of the service procedures require the use of special tools designed for specific procedures. The following tools and supplies are recommended for proper installation of this system: If you do not know how to safely use any of these tools, stop the project and consult a qualified mechanic.

- Dodge Service Manual
- Bench Vise
- Drill motor
- 1/4" Drills:
- Torque Wrench (300 FT-LB capacity)
- 1/2" Drive Ratchet and Sockets
- Assorted Combination Wrenches
- Heavy Duty Jack Stands
- Wheel Chocks (wooden blocks)
- Hydraulic Floor Jack
- Center punch
- File
- Hammer
- Wire Brush (to clean bracket mounting surfaces)
- Black Enamel Paint
- Tape Measure
- Safety Glasses** (wear safety glasses at all times)

J. It is extremely important to replace coil springs, CV flanges, and front drive shaft/pinion relationships as original. Be sure to mark left/right, front/rear, and indexing of mating parts before disassembly. A paint marker or light colored nail polish is handy for this.

K. Suspension components that use rubber or urethane bushings should be tightened with the vehicle at normal ride height. This will prevent premature failure of the bushing and maintain ride comfort.

L. The required installation time for this system is approximately 5 to 6 hours. Check off the box (☐) at the beginning of each step when you finish it. Then when you stop during the installation, it will be easier to find where you need to continue from.

M. This suspension system was developed using the following tire & wheel combination: 35X12.5R17 BFGoodrich KM2 tire, 17 x 9 x 5.5 backspacing wheel. Maximum total backspacing is 6.8". Before installing any other combination, consult your local tire and wheel specialist.

N. Important information for the end user is contained in the consumer/installer information pack. If you are installing this system for someone else, place the information pack on the driver's seat. Please include the installation instructions when you finish.

O. The lifespan of Rancho products depends on many factors. Improper use, abuse or harsh use in general may compromise the integrity of the suspension system and significantly reduce its lifespan. The suspension system is also subject to wear over time. Have the suspension system regularly inspected and maintained by qualified mechanics. If the inspection reveals any damage or excessive wear, no matter how slight, immediately replace or repair the component. The suspension system must be regularly maintained in order to optimize its safe and efficient use. The more severe the conditions under which the suspension system is operated, the more often it must be inspected and maintained.

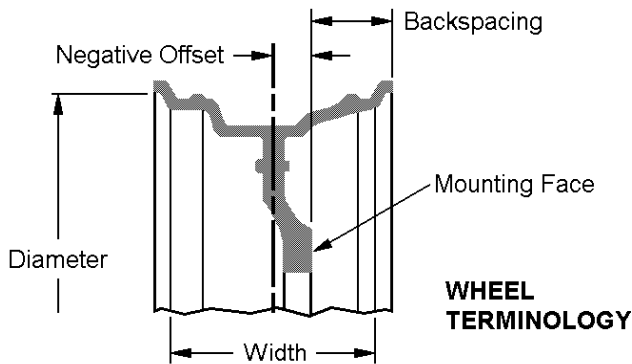

STANDARD BOLT TORQUE & IDENTIFICATION						
INCH SYSTEM			METRIC SYSTEM			
Bolt Size	Grade 5	Grade 8	Bolt Size	Class 9.8	Class 10.9	Class 12.9
5/16	15 FT-LB	20 FT-LB	M6	5 FT-LB	9 FT-LB	12 FT-LB
3/8	30 FT-LB	35 FT-LB	M8	18 FT-LB	23 FT-LB	27 FT-LB
7/16	45 FT-LB	60 FT-LB	M10	32 FT-LB	45 FT-LB	50 FT-LB
1/2	65 FT-LB	90 FT-LB	M12	55 FT-LB	75 FT-LB	90 FT-LB
9/16	95 FT-LB	130 FT-LB	M14	85 FT-LB	120 FT-LB	145 FT-LB
5/8	135 FT-LB	175 FT-LB	M16	130 FT-LB	165 FT-LB	210 FT-LB
3/4	185 FT-LB	280 FT-LB	M18	170 FT-LB	240 FT-LB	290 FT-LB

<p>1/2-13x1.75 HHCS</p> <p>D T L X</p> <p>G = Grade Marking (bolt strength) D = Nominal Diameter (inches) T = Thread Pitch (threads per inch)</p>	<p>Grade 5 Grade 8</p> <p>L = Length (inches) X = Description (hex head cap screw)</p>	<p>M12-1.25x50 HHCS</p> <p>D T L X</p> <p>P = Property Class (bolt strength) D = Nominal Diameter (millimeters) T = Thread Pitch (thread width, mm)</p>	<p>L = Length (millimeters) X = Description (hex head cap screw)</p>
--	---	--	--

The driver of this suspension system recognizes and agrees that there are risks inherent in driving a vehicle with a lifted suspension system, including but not limited to the risk that you could be involved in an accident that would not occur in an unmodified vehicle. By his/her purchase and use of this suspension system, the user expressly, voluntarily and knowingly accepts and assumes these risks, and agrees to hold Tenneco, Inc. and its related companies harmless to the fullest extent permitted by law against any resulting damages.



PARTS LIST
RS66451R9

ITEM	PART #	DESCRIPTION	QTY
1	RS830B	Coil spring 2.5" - Diesel/Black.	2
2	RS176729B	Sway Bar Spacer, Left.	1
3	RS176730B	Sway Bar Spacer, Right	1
	RS860753	Sub Assy, Sway Bar Drop Brkt Hdwr.	1
	RS770080	HHCS, 10MM - 1.50 X 30MM	4
	RS770259	Nut, M10-1.50 NyLock Nut.	4
	RS770064	Washer, M10 (Hardened).	8
4	RS176741	Coil Spring Locator	2
	RS860782	Sub Assy, Coil Spring Locator	1
	RS77032	BHCS, 1/4-20 X .75	2
	RS7710	Nut, 1/4-20 Nylock	2
	RS77841	Washer 1/4 SAE	2
5	RS999044	Rancho RS9000XL Shock.	2
	RS89451	Instructions RS66451R7	1
	RS94180	Information Pack.	1

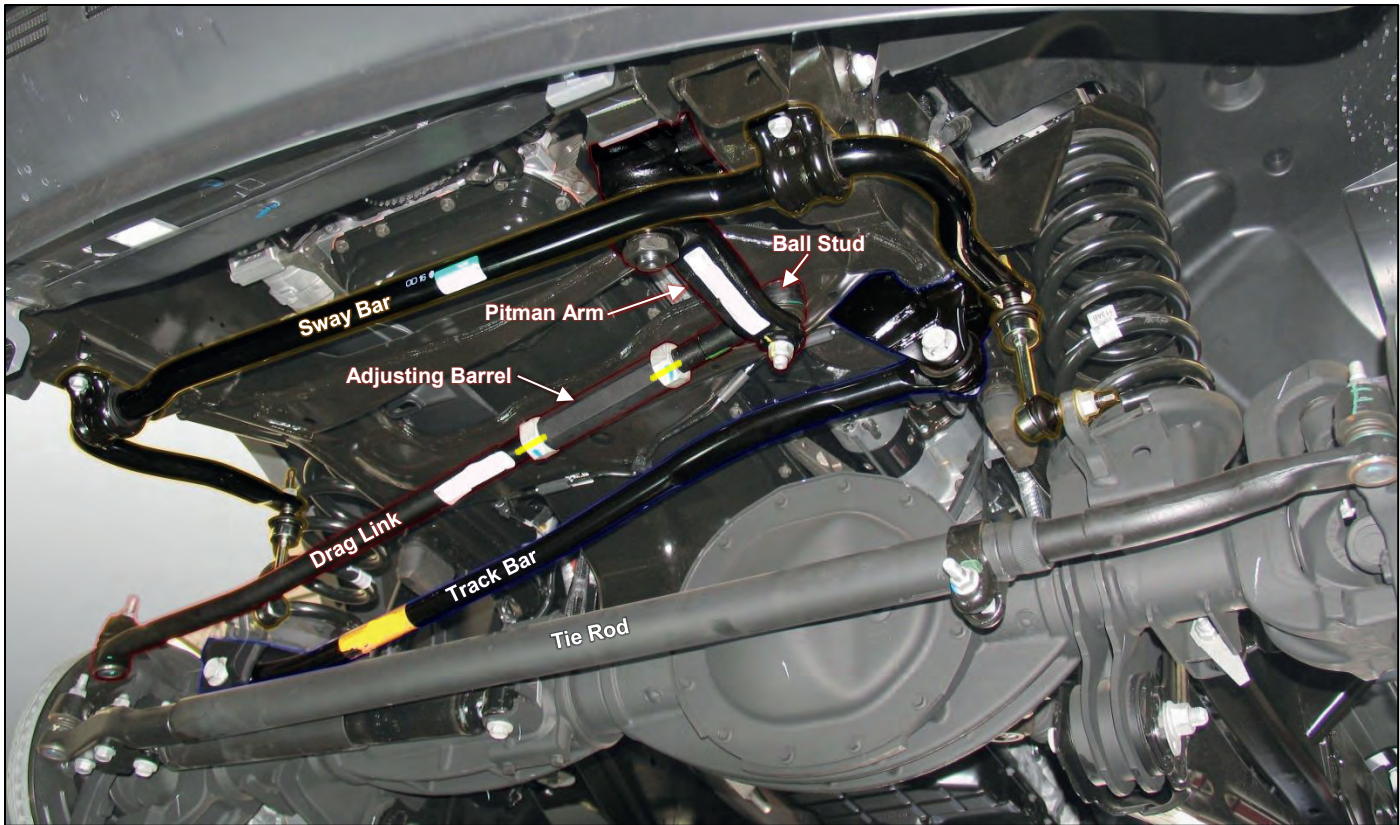

Illustration 1

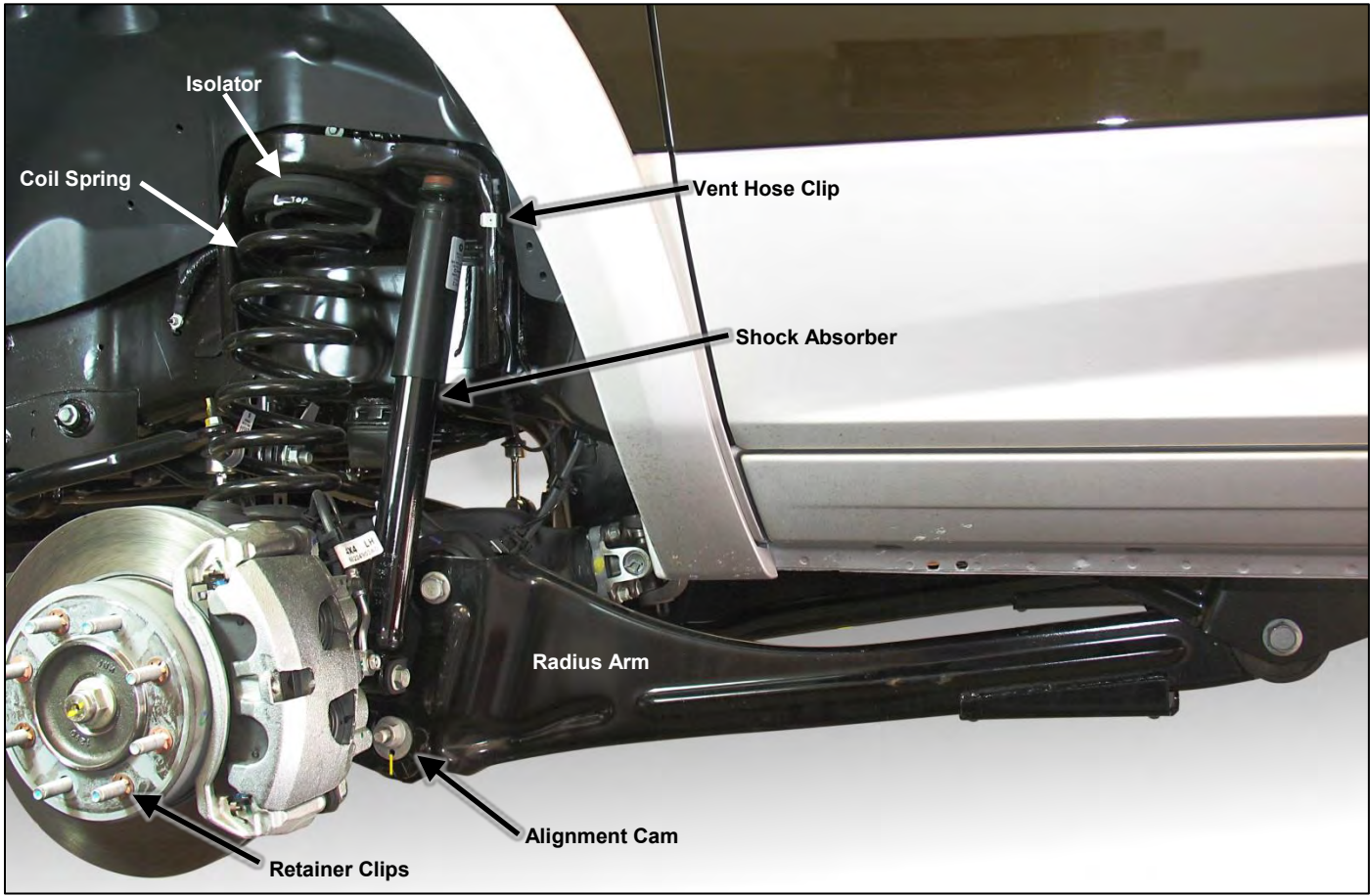

Illustration 2

FRONT SUSPENSION

VEHICLE PREPARATION & SWAY BAR REMOVAL

1) Park the vehicle on a level surface. Set the parking brake and chock the rear wheels. Measure and record the distance from the center of each wheel to the top of the fender opening. See Illustration 3 **Record these measurements in the space provided below.**

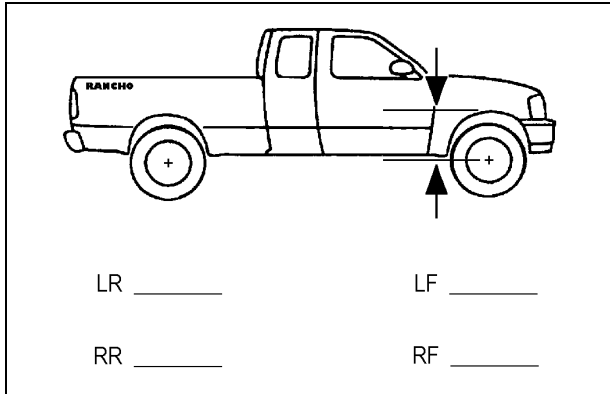

Illustration 3

2) Raise the front of the vehicle and support the frame with jack stands. Remove the front wheels and set them aside.

3) Remove the sway bar mounts at the frame. See Illustration 1.

4) Support the front axle with two floor jacks, one under each coil spring.

5) Mark position of alignment cam bolts on radius arms. See Illustration 2.

6) Loosen, but **DO NOT REMOVE**, radius arm to axle mounting bolts

7) Remove the mounting bolts holding the front brake hoses brackets to axle. There are 2 brackets on each side. Disconnect the front differential vent hose. See Illustration 4.



Illustration 4

8) Remove clip attaching wire to solenoid on passenger side of axle. See Illustration 5.

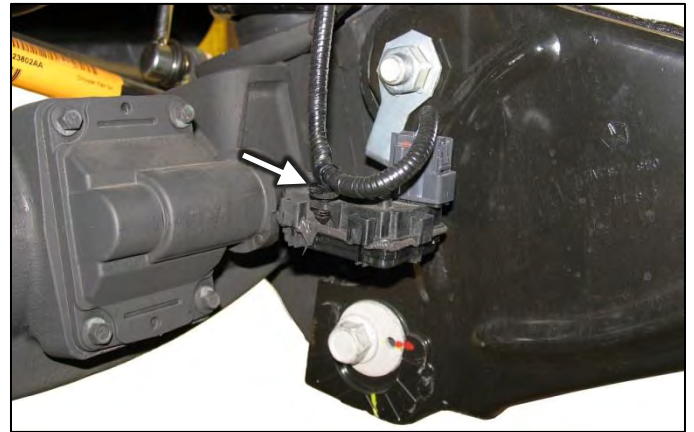

Illustration 5

9) Disconnect the front differential vent hose clip at driver side shock/spring mount tower, and plastic clip on inside of frame rail. See Illustration 2 and Illustration 6.



Illustration 6

10) Remove the front shock absorbers starting at the axle.

11) Carefully lower the axle enough to relieve the tension on the coil springs and remove coils.

⚠ WARNING: Do not allow the axle to hang by any hoses or ABS cables. You could damage the hoses or ABS cables, without this damage being visible to you, resulting in sudden and unexpected failure of a hose or ABS system, and an accident.

COIL SPRING & SHOCK ABSORBER INSTALLATION

- ⚙️ Coil Spring Locators RS176741
- ⚙️ Hardware from Sub Assy RS860782
- ⚙️ Front Coil Springs RS830B
- ⚙️ New Rancho Front Shock Absorbers

NOTE: Both springs will have to be rotated 90° clockwise (when looking from the top)

- 1) Remove the upper spring isolators and cut off locating tabs. See Illustration 7.



Illustration 7

- 2) Mark, center punch, and drill a 1/4" hole on the outside of the upper spring mount dimple, 1/4" from the lower edge of the dimple. De-bur inside of hole with a round or half-round file. See Illustration 8.

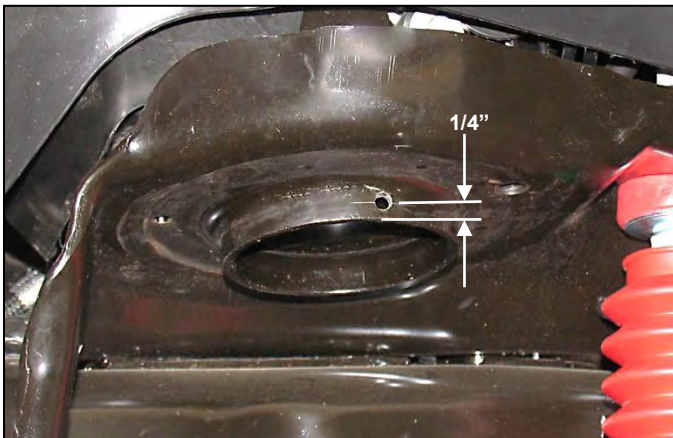

Illustration 8

- 3) Install spring positioner RS176741 into hole of upper spring mount. While holding positioner up against spring mount drill a 1/4" hole through positioner using previously drilled 1/4" hole as a guide.

- 4) Install spring positioner RS176741 using 1/4" hardware supplied in kit RS8860782. Install with button head out, and washer under nut. See Illustration 9.

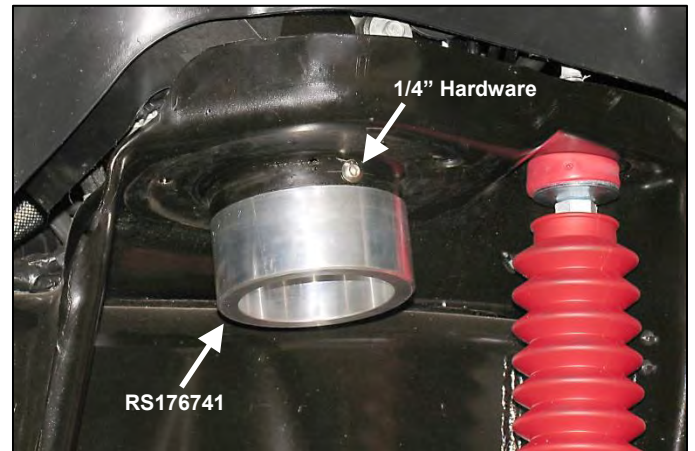
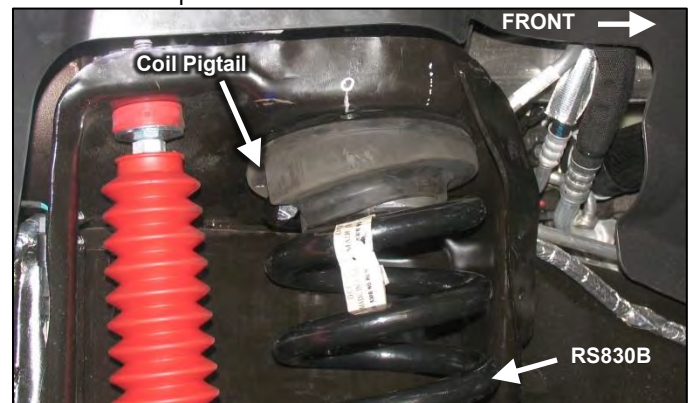

Illustration 9

- 5) Re-install the passenger side upper spring isolator with the coil stop to the rear of the vehicle. See Illustration 10.



Passenger side coil spring after rotating 90° from OE position
Illustration 10

- 6) Place the passenger side spring RS830B in the lower and upper mounts. The top of the spring will have a small flat section on the edge. Align the upper pigtail to the isolator. See Illustration 10.

- 7) Raise the passenger side of the axle just enough to keep the spring from falling out.

- 8) Re-install the driver side upper spring isolator with the coil stop to the outside of the vehicle. See Illustration 11.

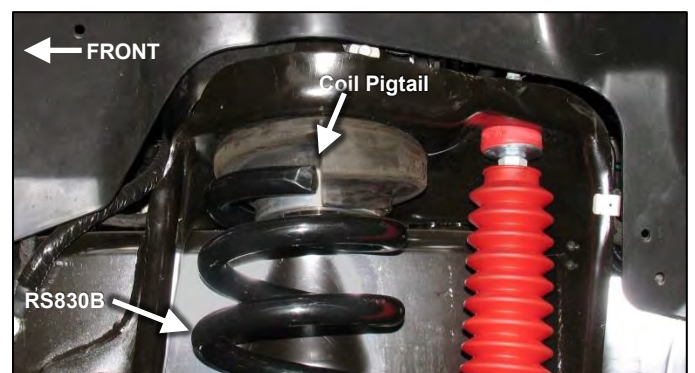

Driver side coil spring after rotating 90° from OE position
Illustration 11

9) Place the driver side spring RS830B in the lower and upper mounts. The top of the spring will have a small flat section on the edge. Align the upper pigtail to the isolator. See Illustration 11.

10) Raise the driver side of the axle just enough to keep the spring from falling out.

11) Install new Rancho shocks in the upper shock mounts.

12) Carefully raise the axle enough to install the shocks on the lower mounts. Attach with the OE hardware and torque to 120 ft. lbs.

13) Re-attach all OE brake line brackets to axle. Re-shape brake line enough to take tension off of rubber line by pushing up on the bend of the hard line. See Illustration 12.

NOTE: Use loctite and take care not to strip out self-tapping screws used on brake line mounts.



Illustration 12

14) Re-attach axle vent hose clips at OE locations. See Illustration 2 and Illustration 6.

SWAY BAR DROP BRACKET INSTALLATION

 Front Sway Bar Drop Bracket RS17729B, RS176730B

 Hardware from Sub Assy RS860753

1) Attach left sway bar drop bracket RS176729B to the driver side the frame with OE hardware. The Rancho logo will face out, and the sway bar will be offset to the front of the vehicle. See Illustration 13.



Illustration 13

2) Attach right sway bar drop bracket RS176730B to the passenger side the frame with OE hardware. The Rancho logo will face out, and the sway bar will be offset to the front of the vehicle. See Illustration 13.

3) Attach the sway bar to the drop brackets with 10mm hardware from kit RS860753. Torque hardware to 40 ft. lbs.

LOWER VEHICLE

1) Install the front wheels and lower the vehicle to the ground. Tighten lug nuts to 165 ft. lbs.

Note: If installing aftermarket wheels, remove rotor retainer clips from wheel studs to allow wheels to sit flush against rotor.

2) Adjust cam bolts so lobe of cam points to rear of vehicle (about 1/4" turn from OE). Tighten radius arm bolts at axle to 220 ft. lbs. See Illustration 14.

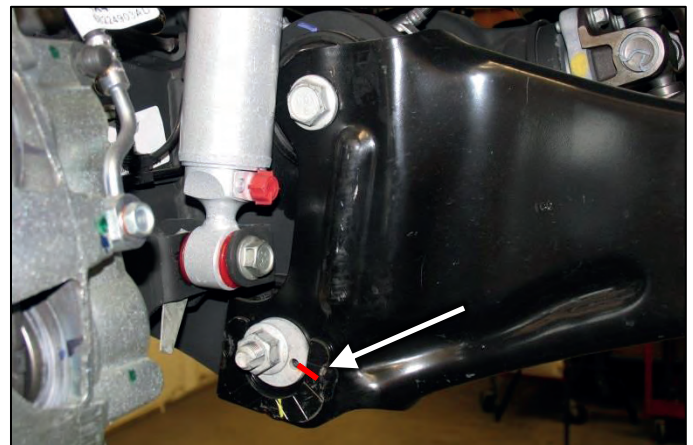

Illustration 14

CHECKS & ADJUSTMENTS

- 1) Turn the front wheels completely left then right. Verify adequate tire, wheel, and brake hose clearance. Inspect steering and suspension for tightness and proper operation.
- 2) With the suspension at maximum extension (full droop), inspect and rotate all axles and drive shafts. Check for binding and proper slip yoke insertion. The slip yoke should be inserted a minimum of one inch into the transfer case and/or transmission.
- 3) Ensure that the vehicle brake system operates correctly. If new brake hoses were installed, verify that each hose allows for full suspension movement.
- 4) Readjust headlamps.
- 5) Center steering wheel. Have vehicle Aligned at a certified alignment facility.

- 6) Measure and record the distance from the center of each wheel to the top of the fender opening. See Illustration 15 **Record these measurements in the space provided below.**

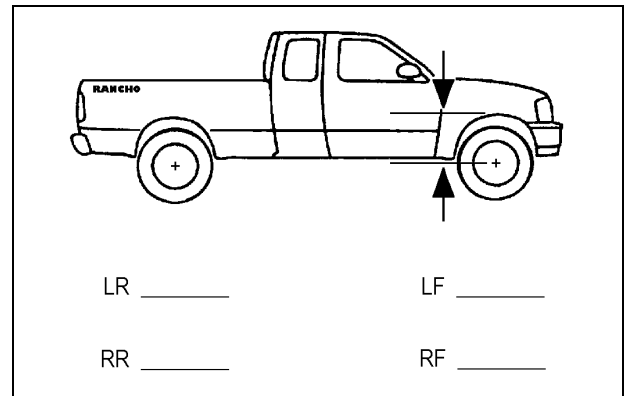

Illustration 15

Please retain this publication for future reference. See Important Note Q.