

Installation Instructions

2018+ Jeep JL
Wrangler Unlimited

IS-26631_RevA



Rail Side Step

Important Safety Information



- CAUTION - Before driving, ensure that the steps are properly secured to vehicle.
- Periodically check all components for tightness.

Contents

NOTE: Actual product may vary from illustration.



Left Step



Right Step



8mm x 35mm Bolt (6)



8mm Lock Washer(6)



8mm Flat Washer(6)



6mm x 25mm Bolt (12)



6mm Flat Washer(24)



6mm Nylock Nut (12)

Tools Required



Socket Wrench



Socket (Set)

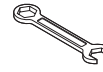

18mm Wrench



Safety glasses

Installation

1

Remove any Factory or aftermarket steps or rock rails present on the vehicle.

2

Start installation on the driver/left side of the vehicle.

Locate the (3) pairs of factory mounting holes along the pinch weld. **See Figure 1.**

The mounting brackets on the Rail Side Steps attach to the holes in the pinch weld and the small factory threaded hole directly behind the pinch weld. **See Figures 2 - 4**

Figure 1



Figure 2

FRONT

Threaded Hole

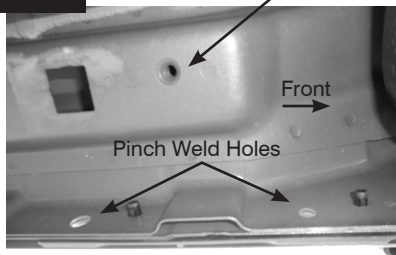

Figure 3

CENTER

Threaded Hole

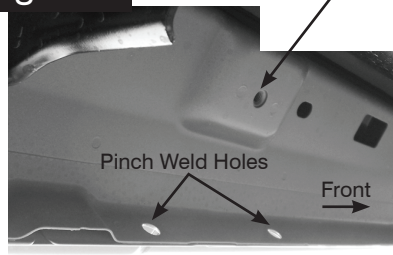
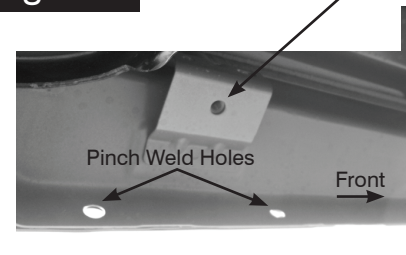

Figure 4

REAR

Threaded Hole



3

Identify the driver/left side step.

The front mount has a cleared opening.

See Figure 5

Figure 5 DRIVER/LEFT FRONT MOUNT

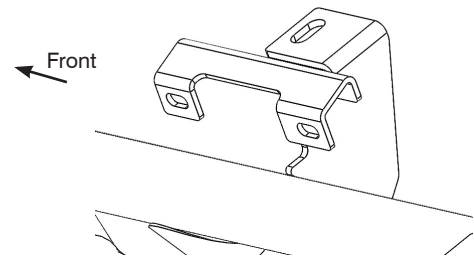

4

With assistance, hold the Driver/left Rail Side Steps up in place against the back of the pinch weld. Line up the (3) welded brackets with the (6) factory holes in the pinch weld. Bolt the brackets to the back of the pinch weld with the included (6) 6mm x 25mm Hex Bolts, (12) 6mm Flat Washers and (6) 6mm Nylon Lock Nuts.

Leave hardware loose at this time.

NOTE: Insert Bolts from outside the pinch weld and out through the Bracket.

Then bolt each top tab on the Trail Crawler Step to the vehicle with the included (1) 8mm x 35mm Hex Bolt, (1) 8mm Lock Washer and (1) 8mm Flat Washer.

Leave hardware loose at this time.

See Figures 6 - 8.

Figure 6 DRIVER/LEFT FRONT MOUNT

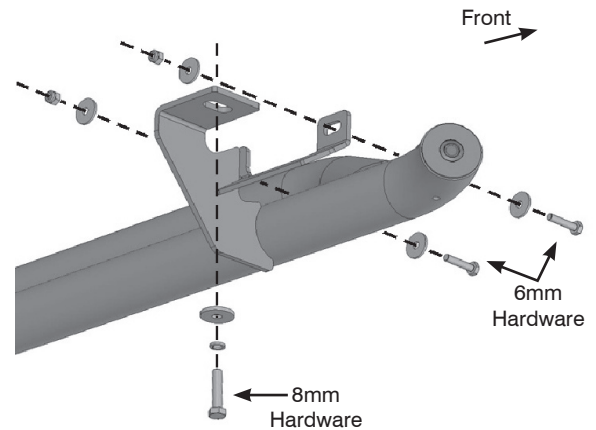
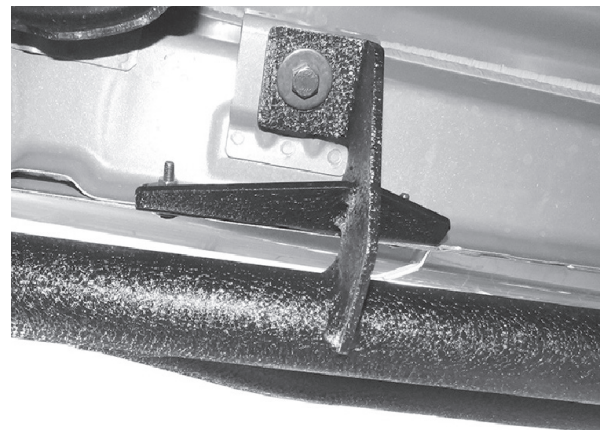

Figure 7 DRIVER/LEFT FRONT MOUNT



Figure 8 DRIVER/LEFT REAR MOUNT



5

Level and adjust steps on the vehicle and tighten all hardware.



6

Repeat all instruction steps on opposite side.

Care and Cleaning

- Rampage products are built to last; any detergent you use to wash your vehicle is sufficient to clean the bumper. Do not use any harsh abrasive detergents. Periodically check and lubricate moving parts.

Congratulations!

You have purchased one of the many quality Rampage branded products offered by Lund International. We take the utmost pride in our products and want you to enjoy years of satisfaction from your investment. We have made every effort to ensure that your product is top quality in terms of fit, durability, finish and ease of installation.



The material that your product is made from can be recycled. Please also consider recycling the packaging that your product came in.



Learn more about running boards and step bars we have.