



2012+ FORD FOCUS, ST, & 2016+ FOCUS RS MUD FLAP INSTALLATION INSTRUCTIONS

PLEASE REVIEW THESE INSTRUCTIONS IN ITS ENTIRETY BEFORE ATTEMPTING INSTALLATION

For high resolution color images of these instructions, please visit <http://www.rallyarmor.com>

To protect your Rally Armor mud flaps, care must be taken during parking and reversing. Rally Armor always recommends professional installation.





Check wheel clearances after installation, especially on vehicles outfitted with non-OEM offset wheels and suspensions. Adjust accordingly.

Rally Armor is not responsible for damage or loss of installed mud flaps.

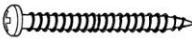

Each mud flap set contains 4 flaps, mounting hardware and brackets (unless otherwise noted).

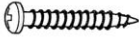
Recommended tools: Philips Screwdriver, Torx Screwdriver, small & long flat head screwdrivers. Jack/Jack stands for rear installation.

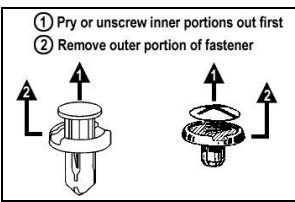
YOUR MOUNTING HARDWARE CONSISTS OF:			INSERT GUIDE	SCREW GUIDE
Quantity	Hardware Item	Item ID		"LONG" (3SS) 
2	Front brackets	HMF27-BR-FR		"MEDIUM" (1.5SS) 
2	Rear Brackets	HMF27-BR-RE		"SHORT" (1SS) 
6	Long Spacers	1 Sp		
6	Short Spacers	.5sp		
14	Round Edge Clips	RoICI		
2	Short Stainless Steel Screws	1SS		
6	Medium Stainless Steel Screws	1.5SS		
6	Long Stainless Steel Screws	3SS		
14	Washers	SmWash		
2	"Wide" Inserts	Ins3		
2	"Flat" Inserts	Ins5		
			HOW TO REMOVE STOCK FASTENERS ① Pry or unscrew inner portions out first ② Remove outer portion of fastener 	

Important Notes

Cautionary Tip: The hardware is strong and self threading but over-tightening the mounting clips is not advised.

Installation Tip: To ease installation and avoid damage to existing OEM clips during removal, a well lit, climate controlled installation environment is recommended.

To the installer: Please return these instructions to the customer after installation. Always test and check wheel clearances before returning vehicle.

To the customer: Retain these instructions after installation. They may be necessary for installing other optional parts or removal of this accessory.

Front Mud Flap Installation

Begin by parking the vehicle on an even surface. Turn the steering wheel as to allow access to the inner wheel well area.

- **(Figure A)** Remove the three OEM fender liner fasteners. Pull liner away to gain access to the interior fender area.
- **(Figure B)** Place 3 round edge clips over mounting tabs (as shown). Replace liner over the mounting points.
- **(Figure C)** Place a round edge clip over lowest mounting point of front bracket. Lay front bracket against logo side of the mud flap.



- **(Figure D)** Place the mud flap with the logo facing the rear of the vehicle, against the corresponding mounting points on the fender liner and bracket. Place a washer (SmWash) over a medium screw (1.5SS) of the original screws through the flap into the mounted clips. Use a short screw (1SS) with a washer for the lowest mounting point on the bracket. Do not fully tighten screws prior to aligning the mud flap.
- **(Figure E)** Expanded diagram. **⚠ TIP:** Ensure the clip mounting points are visible through the liner prior to inserting the screws. You can align them with a small pick or screw driver if needed, then align the screw by hand threading the first few turns. The screw must thread through the rear of the clip.
- **(Figure F)** Align outer edge of the flap by incrementally adjusting the angle of the flap and bracket and walking away from the vehicle until the flap is perpendicular to even ground. Tighten all mounting screws and bracket bolt only until snug and flush with the surface of the mud flap. Do not over tighten

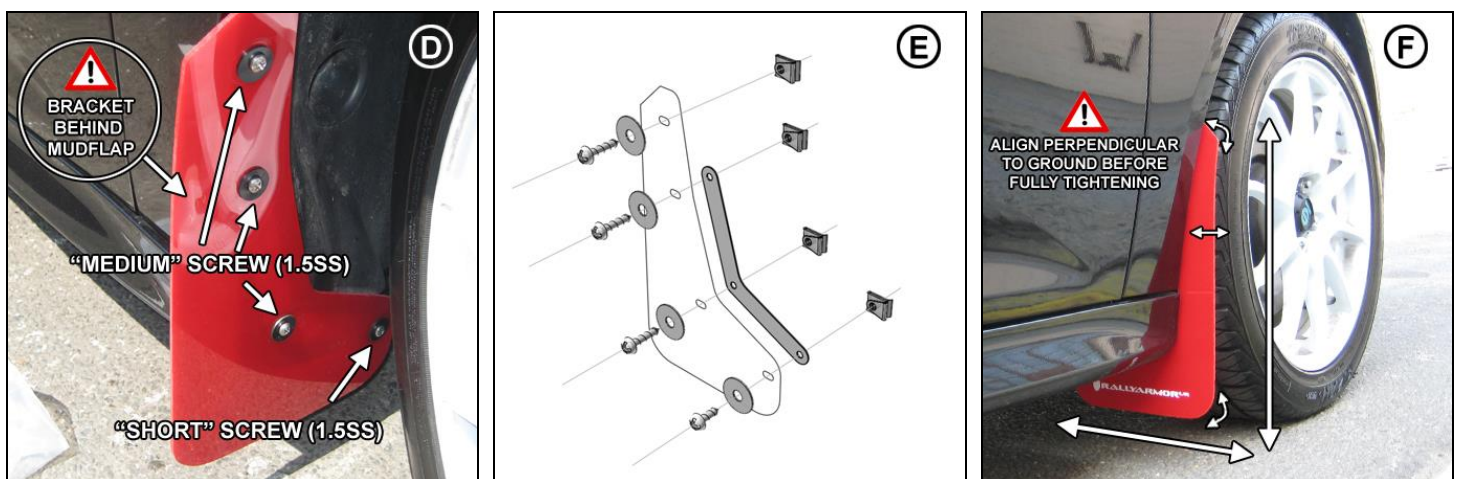

Rear Mud Flap Installation

Remove the rear tires to allow access to rear wheel well area. Consult your owner's manual for information about safe practices for raising and securing your vehicle off the ground.

- **(Figure G)** Remove rear stock retainer screws as shown.
 - **(Figure H)** Pull liner away to gain access to the inner bumper area. Remove stock metal fasteners. Fasteners can be uninstalled with the assistance of a pick.
 - **(Figure I)** Create a matching mounting hole in the liner for the hidden mounting point found underneath.
- ⚠ **TIP:** Expand this point as large as the factory point above it. A larger mounting point **will ease your installation.**

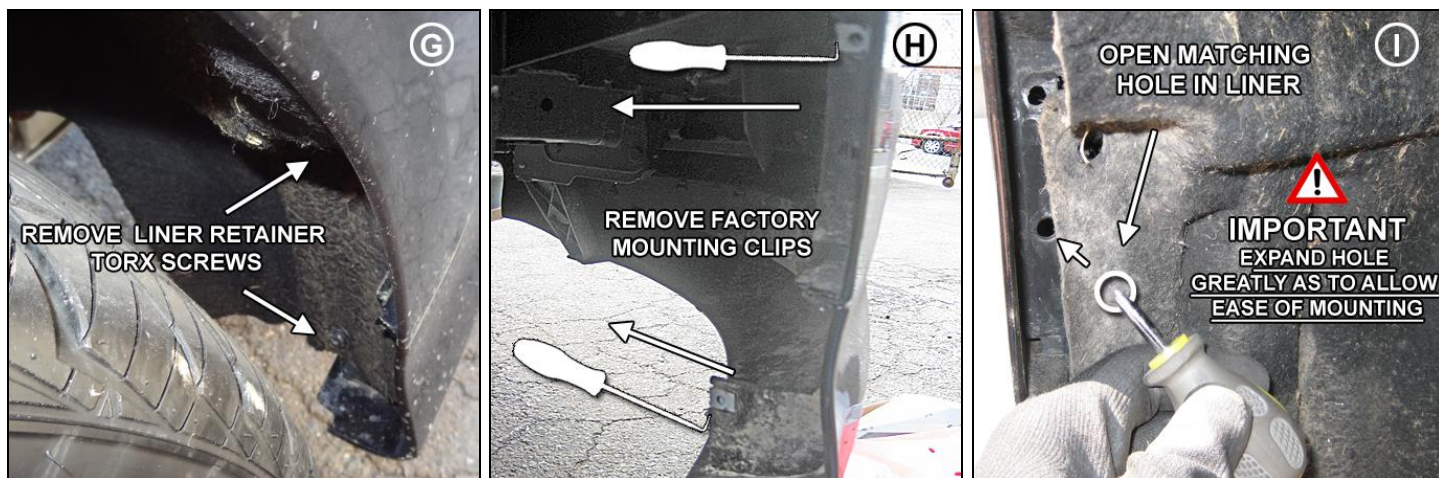

- **(Figure J)** Place 3 Round edge clips over each of the mounting points as shown.
- **(Figure K)** Lay rear bracket against logo side of the mud flap. Place a long screw (3SS) and small washer (SmWash) through the front of the flap, into the bracket. Place a short spacer and a long spacer through the long screw (3SS) on the bracket side as shown.
- **(Figure L)** Place the mud flap with the logo facing the rear of the vehicle, against the corresponding mounting point on the bumper and bracket. Install this screw until the mud flap assembly is loosely secured on to the body of the vehicle. Do not fully tighten



- **(Figure M)** Install a long screw (3SS) and small washer (SmWash) with a short and long spacer in the same manner through the two other mounting points with the flap mounted on vehicle as shown. Do not fully tighten
- **(Figure N)** Working from underneath the rear of the vehicle, perform a visual check to ensure the screws are threading into the clips as shown. **⚠ TIP:** If the screw tip has threaded into the rear area of the clip, the rear portion of the clip will slowly seat against the mounting point as you tighten, even if the washer is flush with the flap.
- **(Figure O)** Align outer edge of the flap by incrementally adjusting the angle of the flap and bracket and walking away from the vehicle until the flap is perpendicular to even ground.

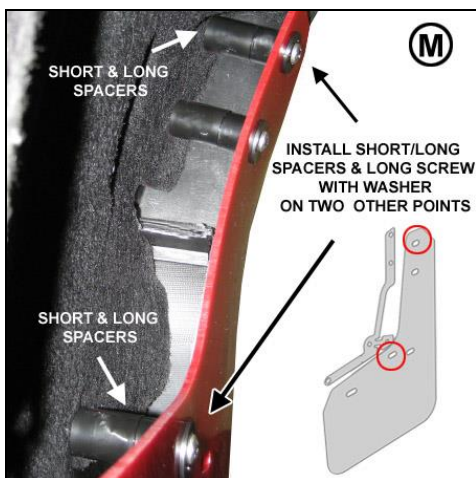

- **(Figure P)** Tighten remaining screws until washer is flush against the flap. Ensure the screws are threaded from the rear of vehicle as shown in Figure N, the rear portion of the clip will slowly seat against the mounting point as you tighten, even if the washer is flush with the flap. Install the wide insert on the outer mounting point and the flat insert on the inner point as shown. The inserts must be seated flush against flap. Hold the rear of the flap with two fingers, seat the base of the insert flat against flap, then push the inner locking mechanism with your thumb afterwards.
- **(Figure Q)** (Optional) You can adjust your rear mud flap to lay perpendicular with the length of the vehicle by gently pushing the rear portion of the bracket back.
- **(Figure R)** You can further adjust the flap along the bumper by adjusting the bracket and mounting screws by hand as shown.

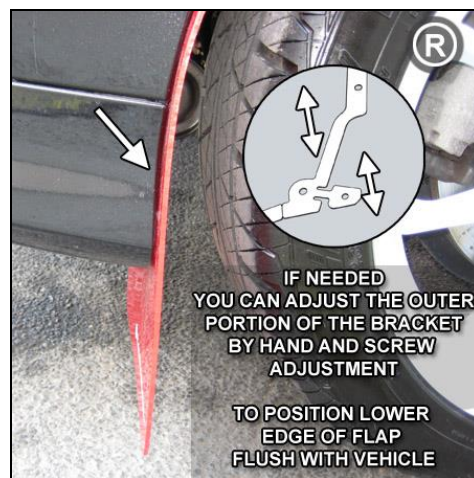
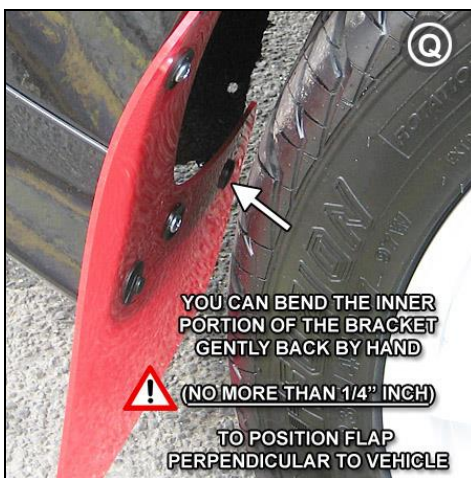
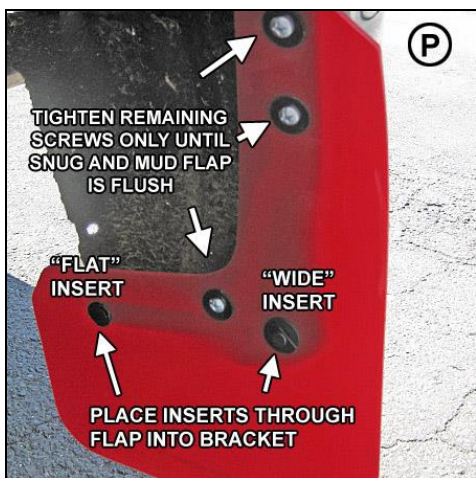

RALLYARMOR® HMF - 27 Mounting Diagram

REAR

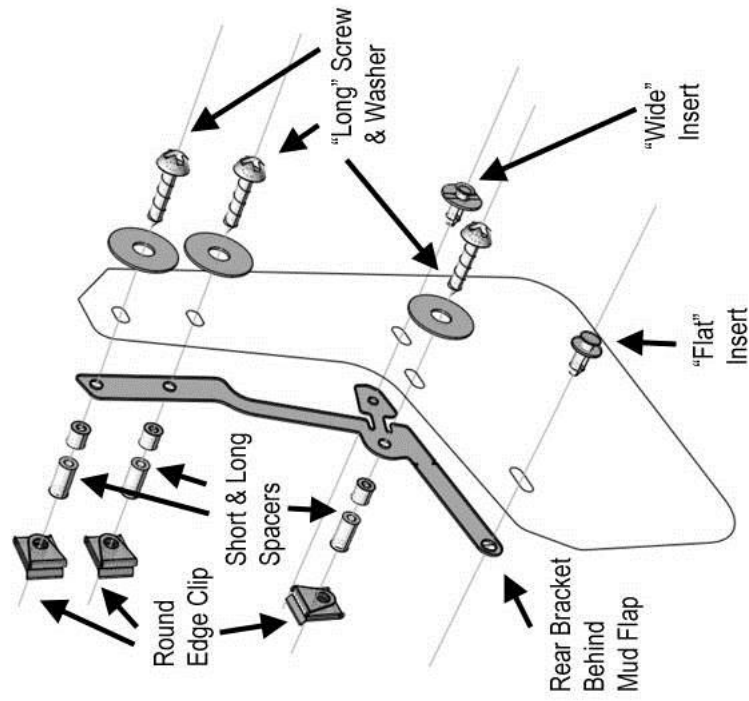

FRONT

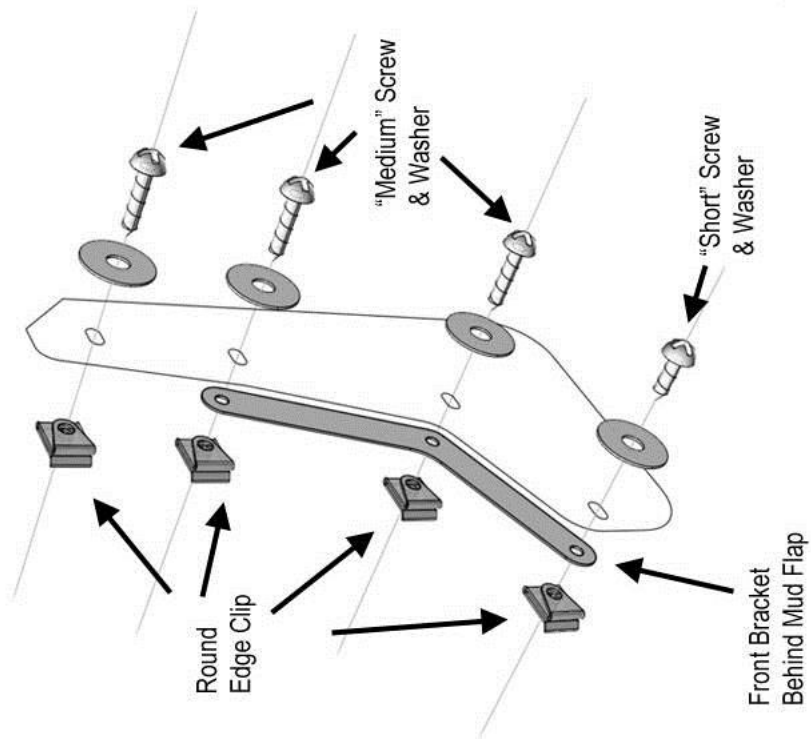

All content included on these instructions is the copyright of Rally Armor® LLC