

INSTALLATION INSTRUCTIONS

FUEL RAIL

MITSUBISHI EVO X

WARNING: DON'T SMOKE OR WORK WITH OPEN SPARKS WHILE WORKING ON THE FUEL SYSTEM

PREPARING THE VEHICLE: Remove the fuel pump fuse and start the engine. Allow the engine to stall. This will relieve any fuel pressure in the lines. Replace fuel pump fuse. Disconnect the negative battery cable. Remove the charge air tube (intercooler tube) that is routed over the top of the engine. Remove the plastic engine cover.



1. Locate the fuel feed line near the OEM boost control solenoid. The fuel feed line is a rubber hose with a red clip that attaches to the hard fuel line. Use a pick or small tool to remove the red clip and disconnect the fuel hose from the hard line.

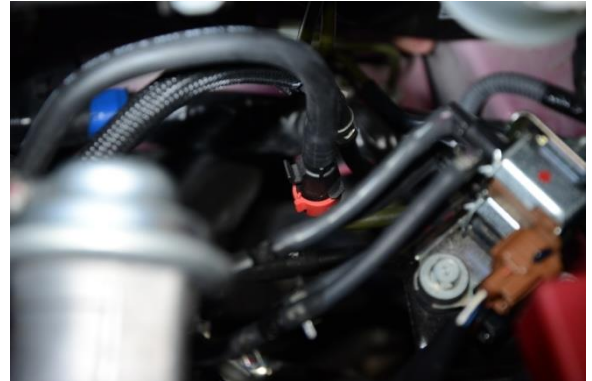

2. Locate the other end of the fuel hose at the fuel rail hard tube. Another red clip is used here. Use a small tool to pull the red clip to the open position, as shown. Disconnect the fuel hose from the fuel rail hard line. Remove the fuel hose from vehicle.

Next, find the PCV valve hose that runs next to the FPR that connects the valve cover to the intake manifold. Using a pair of pliers, loosen the two spring clamps on each end and remove it from the vehicle.

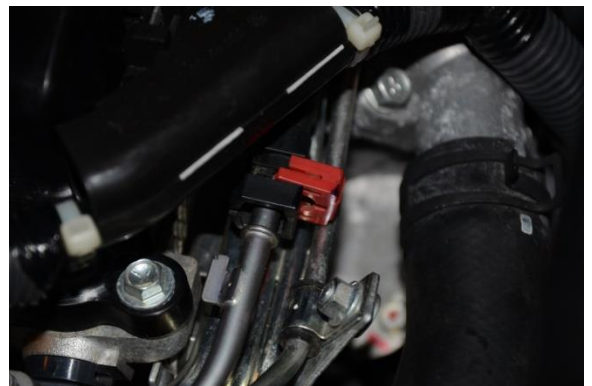

3. On the intake manifold, remove the two M6 bolts holding the black sheet metal bracket. Unclip the wiring harness from the bracket and remove the bracket.

NOTE: Organize all fasteners and parts as they are removed from the vehicle as some will be reused.

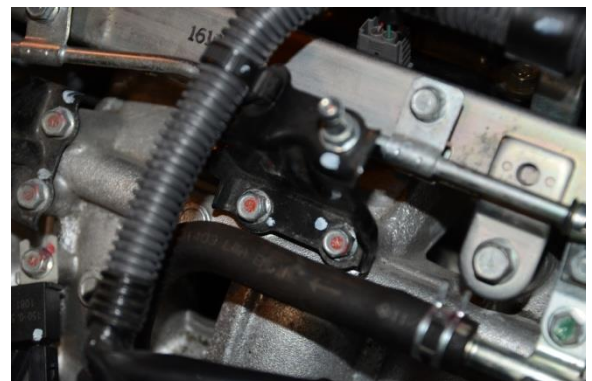

4. Pull the vacuum hose off the fuel pressure regulator barbed (left side of picture).

Loosen the spring clamp and disconnect the fuel return hose from the hard line (circled).

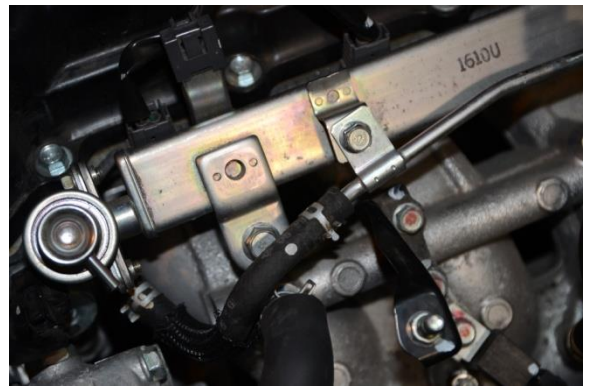

5. Remove the two M6 screws holding the fuel return hard line to the fuel rail (circled).



6. Remove the M6 nut and screw for the third bracket holding the fuel return hard line. Remove the small bracket. This will not be reused. Replace the M6 screw and tighten.

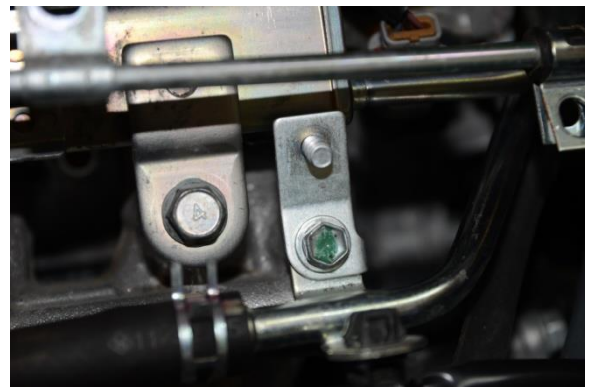

7. Remove the cushion clamp from the fuel return hard line that remains from the previous step. The rubber sleeve is left in place on the hard line.



8. Unplug all 4 fuel injector electrical connectors.



9. Use a 12mm socket and remove the two M8 bolts securing the fuel rail to the intake manifold.

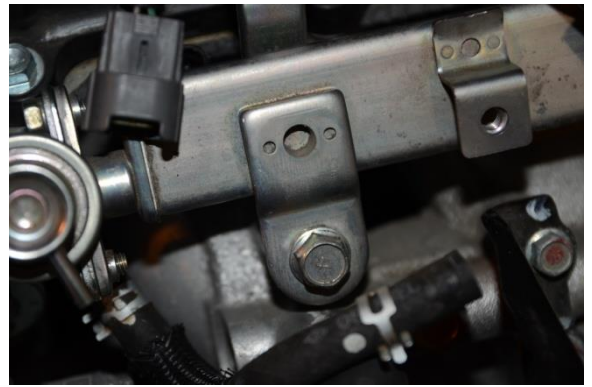

10. Remove the fuel rail from the vehicle. It will contain fuel. Drain excess fuel into a safe container for disposal.



11. Be careful to not lose or drop the plastic mounting boss spacers in the engine bay. These will be required for the Radium fuel rail.



12. Remove the fuel injectors and fuel pressure regulator from the stock fuel rail. The fuel injector clips will not be reused.



13a. If the fuel rail was produced before December 2016, the end port (shown) of the fuel rail is threaded for 3/8" NPT (tapered pipe thread). The adapter fitting must use PTFE (Teflon) paste on the threads. Hand tighten, then tighten another 1.5 to 3 turns with a wrench.

If re-using the OEM FPR, install the flange fitting (shown), following the steps outlined in the paragraph above. Then clock it to the desired position and install the OEM regulator.



13b. If purchased after Dec 2016, all ports are threaded for -8AN ORB.

If re-using the OEM FPR, use the two-piece adapter 20-0301. Lubricate the O-ring on the adapter bushing and install it into the end port of the fuel rail. Next, slide on the adapter flange, making sure that the side with the recess is outward and the flange sits flush with the circular adapter bushing face.

Install the fuel pressure regulator reusing the factory bolts. Clock the regulator to the proper orientation then tighten the bolts.



14. If using the 20-0112-10 or 20-0112-PK install the -6AN adapter into the inlet port of the fuel rail, as shown. ***If installing as part of the Evo X Fuel Delivery System, construct the fuel rail as shown in "Configuration 4" at the bottom of this document.***

Make sure an O-ring is used on the side of the adapter fitting that screws into the fuel rail. **To prevent failure, lubricate this O-ring prior to assembly.**



15. If applicable, install the fuel pressure regulator hard line using the supplied M6 hardware (shown) and a 5mm Allen hex wrench.

Install the fuel injectors into the fuel rail. **To prevent failure, the O-ring MUST be lubricated prior to assembly.**



16. Position the fuel rail in place on the intake manifold. Line up the mounting tabs. Make sure all fuel injectors are seating properly in their ports. Using a 6mm Allen hex wrench, secure the fuel rail with the 2 included M8 socket head bolts, as shown.

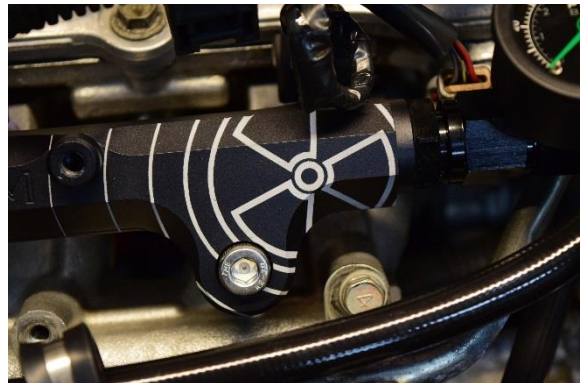

17. If using a -8AN inlet fitting on the fuel rail, it may be necessary to trim the cam angle sensor plug. Use small cutters and trim the connector in the area circled. This trimming does not impact the locking function of the connector.

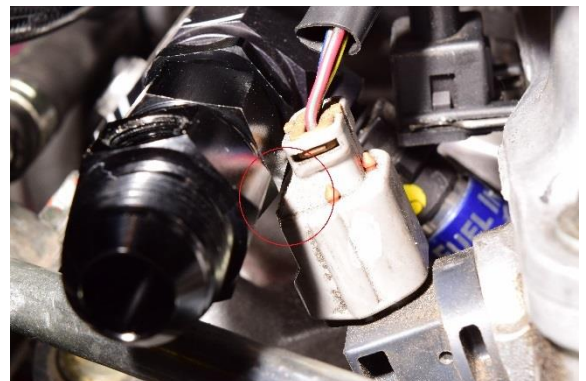

18. Reinstall the black bracket removed in step 3, as shown.

Next, reinstall the PCV valve hose. If using the optional gauge, fuel pulse damper, or OEM fuel pressure regulator, route the PCV hose in between the two components, as shown.

If reusing the OEM fuel pressure regulator and/or the optional fuel pulse damper, connect a vacuum hose to the intake manifold.

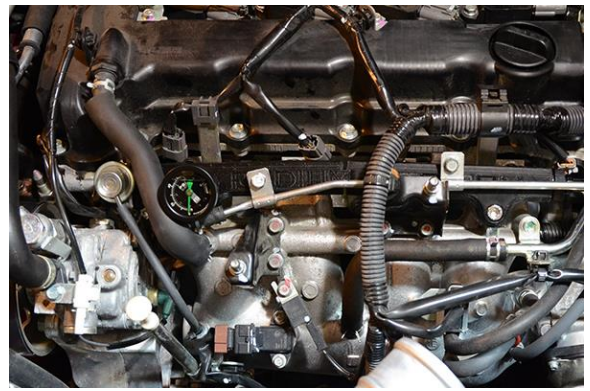

19. If installing a 20-0112-10 or 20-0112-PK, remove the screw and green lock from the included SAE adapter fitting using a 5/64" Allen wrench. Next, assemble and torque the SAE adapter fitting to the PTFE hose's -6AN 90 degree end. Lightly lubricate the hard line near the firewall with oil and then fully insert the included SAE fitting.

Line up the hole and place the green lock onto the SAE fitting. Secure the small screw (as shown) using the 5/64" Allen hex wrench.



20. Install the 45 degree hose end to the fuel rail inlet port using the supplied -6AN male fitting and a 11/16" wrench.

Reconnect the battery and cycle the ignition to prime the fuel pump. Check for leaks. Start the engine and recheck for leaks.

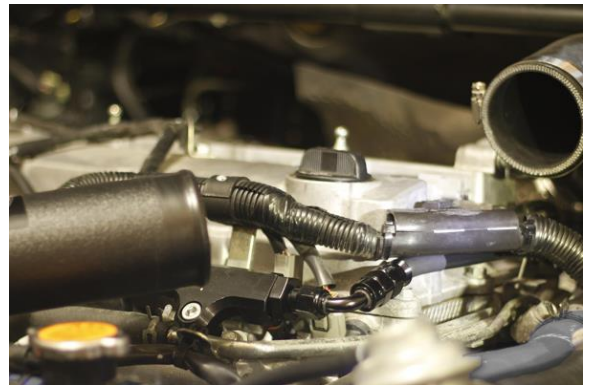

Plumbing Examples

If using Radium fuel pump hanger return kit 20-0246, use Configuration 4.

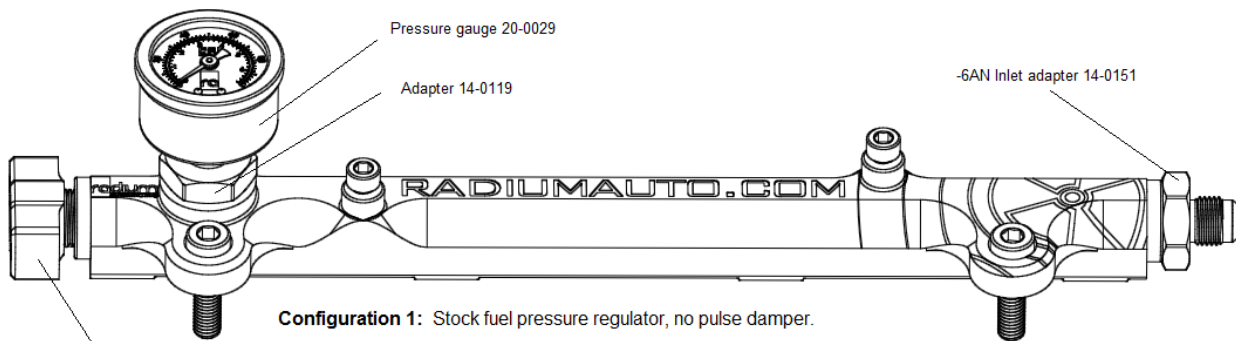

Configuration 1: Stock fuel pressure regulator, no pulse damper.

OEM Regulator Adapter for NPT: 14-0125
OEM Regulator Adapter for 8AN ORB: 20-0301

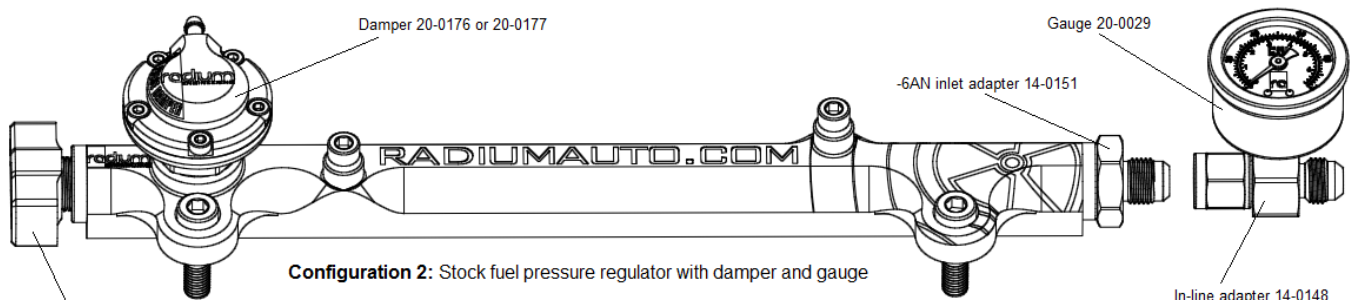

Configuration 2: Stock fuel pressure regulator with damper and gauge

OEM Regulator Adapter for NPT: 14-0125
OEM Regulator Adapter for 8AN ORB: 20-0301

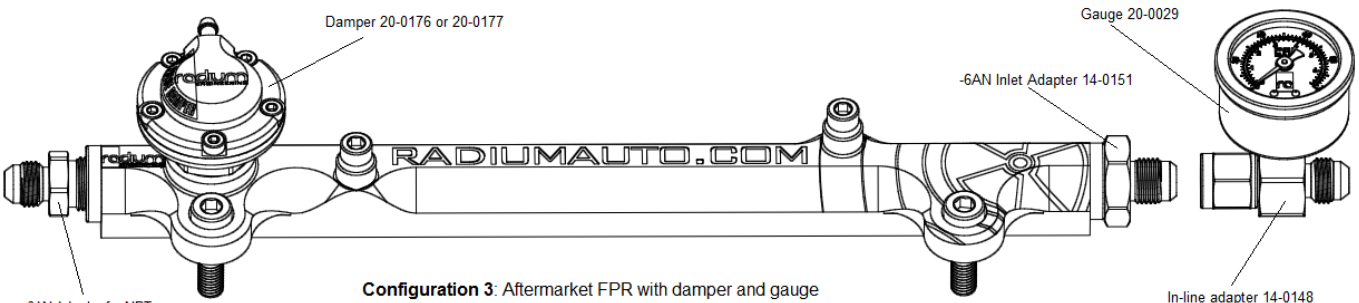

Configuration 3: Aftermarket FPR with damper and gauge

-6AN Adapter for NPT
14-0174
-6AN Adapter for 8AN ORB
14-0151

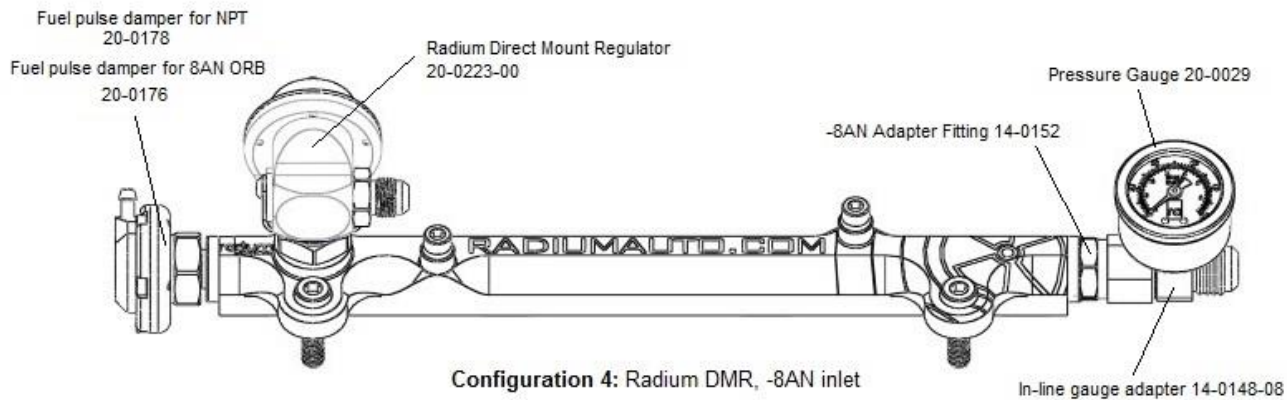

Configuration 4: Radium DMR, -8AN inlet

[View other performance fuel system parts made by Radium on our website.](#)