

# PROFORM

2017



  
FORD PERFORMANCE



  
**PERFORMANCE**  
OFFICIAL LICENSED PRODUCT

## FACTORY PERFORMANCE™ PARTS



## WHAT'S INSIDE?

Air Cleaner Accessories .....	15,25	Engine Building Tools .....	63-83	Pulleys, Mustang .....	59
Air Cleaner Center Nuts .....	15,25	Fans, Electric.....	21,50	Pushrods .....	49
Air Cleaner Kits .....	14-16,24,25,60	Ford Parts .....	20-28,59	Radiator Overflow Canisters .....	45
Alternator Brackets .....	21,41	Freeze Plug Inserts .....	17	Radiator Caps .....	45
Alternators .....	21,40-41	Freeze Plug Kits .....	57	Ring Compressors .....	67
Apparel.....	62	Fuel Pump Block Off Plates .....	13,29,60	Ring Filers.....	66
Banners.....	62	Funnels, No-Mess .....	80	Rocker Arms .....	52-53
Bolts & Fasteners.....	13,28,56,61	Gaskets .....	61-62	Scales, Balancing / Vehicle .....	64-65
Bosch Parts .....	51	Gear Drives .....	57	Shift Lights .....	59
Caps, Air Breather / Oil .....	13,17,28,60	Gear, Distributor (Iron) .....	49	Socket Assist, Wrench.....	80
Caps, Distributor.....	48	General Motors Licensed Parts.....	2-21	Starters .....	21,42-43
Carburetor Accessories.....	34-37	Grommets.....	17,61	Stud Girdles .....	53
Carburetor Base Plates .....	35,37	Guide Plates.....	53	Thermostats, Adjustable .....	50
Carburetor Fuel Bowls .....	35	Harmonic Balancers.....	57	Timing Chain Covers.....	16,60
Carburetor Main Bodies .....	34	Harmonic Balancer Covers.....	17,60	Timing Light, Self-Powered .....	82
Carburetor Spacer Kit .....	37	Harmonic Balancer Tools .....	70-71	Timing Pointers.....	16,61
Carburetor Tools .....	37,81	Header Bolts.....	56,60	Tools, Engine Building .....	63-83
Carburetors .....	30-33	Hold Down Clamps, Distributor .....	49	Vacuum Advance, Adjustable.....	48
Catalogs, Merchandisers.....	56,62	Ignition Accessories.....	40-43,48-49	Valve Cover Acces .....	3,9,13,17,28-29,60-61
Chrome Parts, Proform.....	60-61	Key Chains .....	21,29,62	Valve Covers .....	2,8-12,22-23,61
Coils, Ignition.....	48-49	LS Parts &Tools.....	2-3,42,70-72,76	Valve Cover Wing/Mini Nuts .....	13,28,61
Decals .....	62	Master Cylinder Covers.....	17	Water Necks.....	13,61
Degree Wheels/Kits.....	72-73	Micrometer Sets .....	82	Water Pumps, Electric .....	19,44
Differential Covers .....	16,54	Mustang Parts .....	22-29,59	Water Pumps, Mechanical .....	45
Dipsticks, Oil & Transmission....	13,29,57,59,60	Pans, Oil & Transmission.....	17,55,57,59,61	Wire Looms & Dividers .....	17,29
Distributor Components.....	48-49	Perfect Launch® Differential Covers.....	54	Wrenches.....	74,78-79
Distributors .....	20,46-47	Pinion Setting Tool.....	78		
Drain Plug, Oil (No-Mess).....	60,80	Poly Locks, Rocker Arm .....	53		
Dress-Up Kits.....	4-7,26,60				



# NEW PRODUCTS!

Slant-Edge Air Cleaners for Chevy (p. 14) and Ford (p. 24 & 27)



New Ford Performance Emblems!



Professional HD Valve Spring Compressor (p. 68)



Buick 455 Roller Rockers (p. 53)

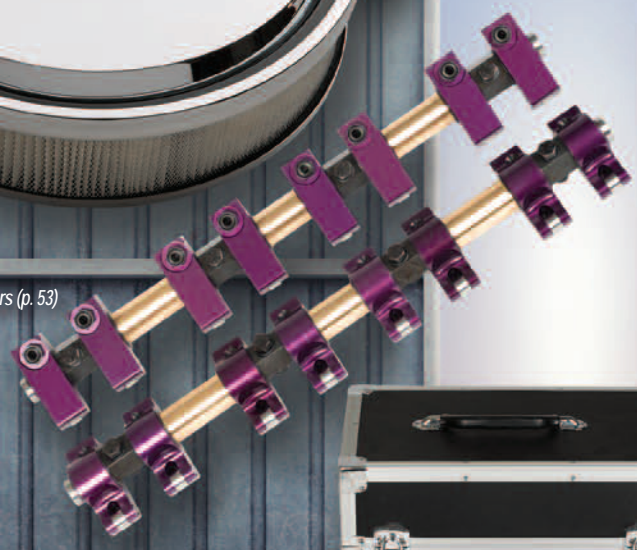

Staggered Mount Chevy Starters & 2 KW Versions for More GM Applications (p. 42)



Slim 7,000 lb Wireless Scale (p. 64)



# LS SLANT-EDGE VALVE COVERS

## HOT Parts for Your LS Engine!

Still trying to find your LS engine amongst a congestion of wires, tubes, and ignition coils? Not Any More! Through innovative engineering, Specialty Auto Parts U.S.A., Inc. has developed a valve cover that will take your stock LS engine, and give it a totally personalized look. These new valve covers are taller than stock valve covers, and can accommodate a wide variety of large valve train applications. Seven choices, with raised or recessed Chevrolet and Bowtie emblems, LSX emblem or no emblems at all for a self-customized look. Mounting studs, and oil-restricting baffles are included. Includes threaded mounting holes for the Integrated Coil Bracket.

Sold in Pairs. U.S. Pat. D657,798. Your style choices include:

- A. 141-261....Chevy Orange, raised emblem
  - B. 141-262....Black Crinkle, raised emblem
  - C. 141-263....Cast Gray, raised emblem
  - D. 141-264....Polished, recessed red/black emblem
  - E. 141-265....Chrome, recessed red/black emblem
  - F. 141-266....Polished, no emblem
  - G. 141-257....Chevy® Orange, raised LSX® emblem
- 66331..... Replacement mounting bolts (8 bolts)  
 66331P..... Replacement mounting Bolt (1 bolt)



Fits GM LS engines



### Integrated Coil Bracket

What to do with those pesky coils in such a confined space?

In addition to new LS Slant-Edge valve covers, Specialty has designed an attractive way to lift your coils off your valve cover so you can see the Chevrolet emblem. A unique rail mounting system attaches to the threaded holes on the valve cover, and the individual coils attach to the rail so they can be mounted in multiple positions. All necessary hardware included.

Fits GM LS engines

69520 ..... Coil bracket for LS 1st Gen style coils

69521 ..... Coil bracket for LS 4th & 5th Gen style coils

### Coil Relocation Extension Cords

If you're thinking of relocating your LS ignition coils somewhere out of sight, then you'll need at least one of these extension cords, because you'll have to relocate the wiring harness also. Includes authentic Delphi connectors and is build and tested to withstand life in the engine compartment. Sold as individual cords.

A. 69525.....18" Extension Cord

B. 69526.....46" Extension Cord



A.

B.

### Spark Plug Wires

If you decide to use Specialty's Integrated Ignition Coil Bracket to mount your coils, you will need slightly longer spark plug wires. 13"-15" wires are needed.

MSD 8.5mm Wires, P/N 39849, are recommended.

### Cylinder Head Valve Cover Mounting Bolts

These mounting bolts are necessary to mount Chevrolet and Bowtie LS valve covers part numbers 141-257, and 141-261 thru 141-266 to LSX-DR cylinder heads.

66330.....Mounting Bolts (8 bolts)

66330P.....Mounting Bolt (1 bolt)

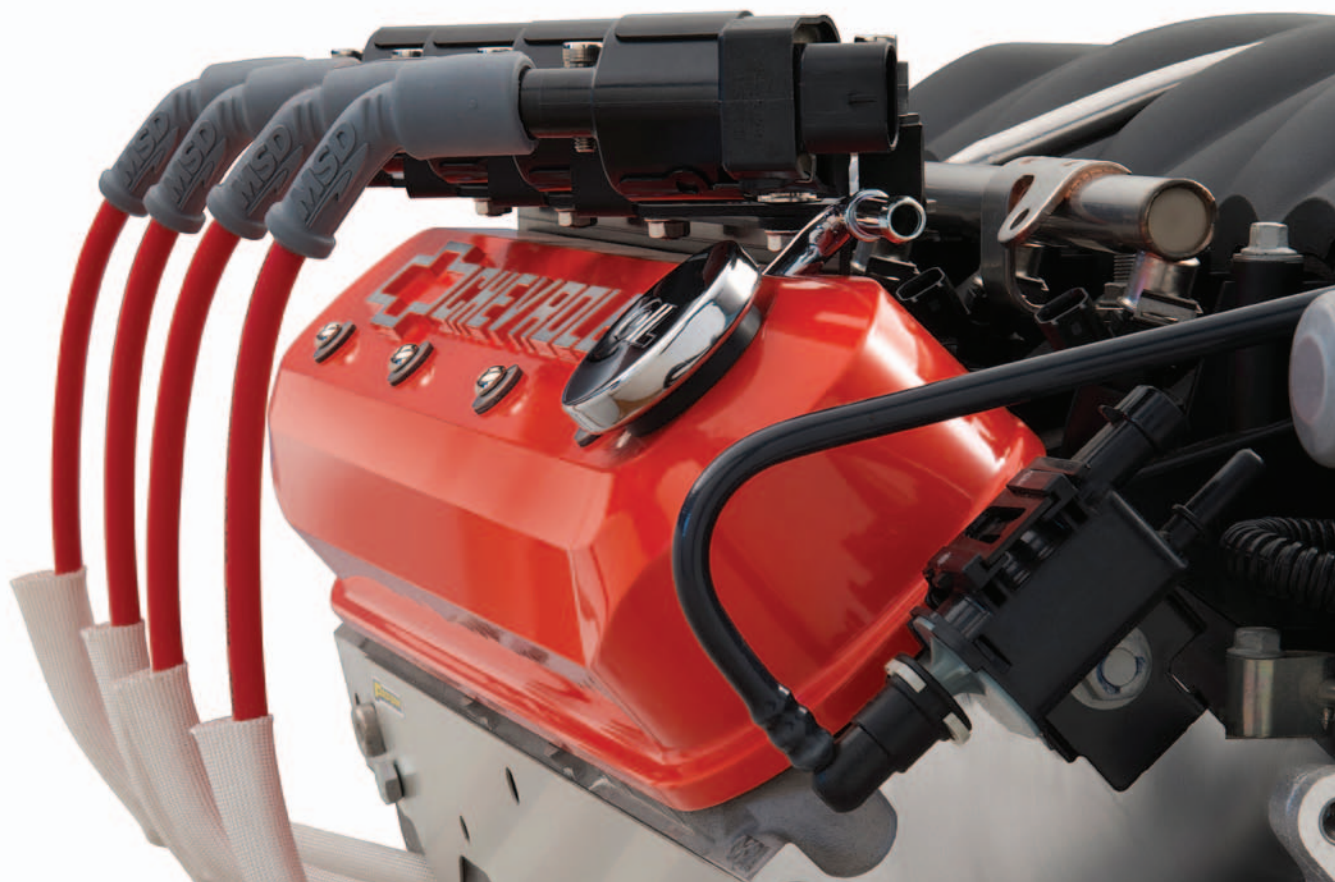





### Street Performance Chrome Kit

For Chevrolet small-block, V8, 1958-86.

This complete kit includes chrome air breather, plus two tall baffled valve covers, timing chain cover, 14-inch air cleaner, 8 wing nuts and 8 hold-downs bearing the popular Chevrolet and Bowtie Emblems in red/black.



141-900..... Full Kit. Includes one set of tall valve covers, air cleaner, timing chain cover, breather cap, 8 wing nuts and 8 hold-down clamps

Parts available separately

A. 141-616 .. Chevy Bowtie push-in air breather cap\*

B. 141-902\*\*Chevy Bowtie wing nuts, red Emblem

C. 141-903\*\*Chevy Bowtie hold downs, black & red Emblems

D. 141-904 .. Chevy Bowtie timing chain cover, black & red Emblems

E. 141-905 .. Chevy Bowtie valve covers, tall, black & red Emblems (Available separately in short as part number 141-899)

F. 141-906 .. Chevy Bowtie 14-inch air cleaner, black & red Emblems

G. 141-333..Large chrome Bowtie center nut

\*\*Packaging contains 4 pcs. Order 2 packages per engine.



### High-Tech Collector's Series Kit

Give your engine a truly unique and striking look. These stamped steel bolt-on parts are electrostatically painted & baked with durable high-tech, gray epoxy, finished with the famous Chevrolet and Bowtie Emblems.

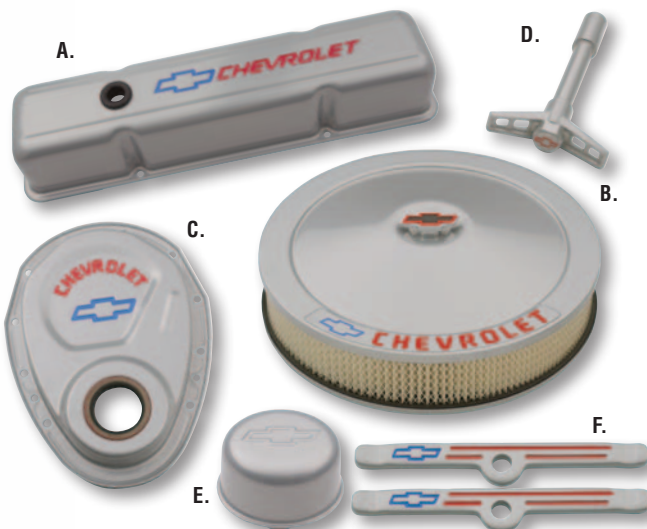

141-360..... Full Kit. Includes one set of valve covers, air cleaner, timing chain cover, breather cap, 8 wing nuts, and 8 hold-down clamps.

Parts available separately

A. 141-361 .... Chevy Bowtie, metallic gray valve covers, tall with baffle. Chevy S/B V8.

B. 141-362 .... Chevy 14" classic, metallic gray air cleaner kit w/ Bowtie center nut.

C. 141-363 .... Chevy Bowtie timing chain cover, metallic gray, Chevy S/B V8 '69-'91 and V6/90".

D. 141-364\*\*.. Chevy Bowtie valve cover wing nuts, metallic gray chevy S/B, B/B & V6.

E. 141-365 .... Chevy Bowtie push-in air breather cap, metallic gray, 3" diameter\*.

F. 141-366\*\*.. Chevy valve cover hold-down clamps, metallic gray, chevy S/B V8 & V6/90" thru 1986.

\*\*Packaging contains 4 pcs. Order 2 packages per engine.





### Black Crinkle Kit

One of the most popular and durable dress-up kits available today! This black crinkle kit, with its distinctive look and boldly striking wording, comes with everything you need for race day or show day!

141-758..... Full Kit. Includes one set of valve covers, air cleaner, timing chain cover, breather cap, 8 wing nuts, and 8 hold-down clamps.

#### Parts available separately

- A. 141-751\*... Chevy Bowtie, black crinkle, valve covers tall with Baffle, Chevy S/B  
 B. 141-753 .... Chevy Bowtie timing chain cover, black crinkle, Chevy S/B V8 '66-'91 and V6/90°  
 C. 141-752 .... Chevy 14" Classic, black crinkle air cleaner kit with Bowtie center nut

D. 141-756\*\*..Chevy Bowtie valve cover wing nuts, black crinkle, S/B & B/B V6.

E. 141-754 .... Chevy Bowtie push-in air breather cap, black crinkle, 3" diameter\*

F. 141-757\*\*..Chevy Bowtie valve cover hold-down clamps, black crinkle, S/B & B/B V8/90° thru '86.

\* Available separately with short height, as PN 141-750

\*\* Packaging contains 4 pcs. Order 2 packages per engine.

### Collector's Edition Engine Dress-Up Kits



#### Chevy® Orange Kit

Latest Look! For Chevrolet small-block, V8, 1958-86. This complete kit includes an air breather, plus two tall baffled valve covers, timing chain cover, 14-inch air cleaner, 8 mini nuts and 8 hold-downs bearing the popular Chevrolet and Bowtie Emblems in black.

141-780..... Full Kit. Includes one set of tall valve covers, an air cleaner kit, timing chain cover, breather cap, 8 hold-down clamps, and 8 mini nuts

#### Parts available separately

- A. 141-784 .. Chevy Bowtie, orange, valve covers, tall with baffle, Chevy S/B.  
 B. 141-785 .. Chevy 14" Classic, orange air cleaner kit with Bowtie center nut  
 C. 141-786 .. Chevy Bowtie push-in air breather cap, orange, 3" diameter\*  
 D. 141-783 .. Chevy Bowtie timing chain cover, orange, Chevy S/B V8 '66-'91 and V6/90°  
 E. 141-782\*\*Chevy Bowtie valve cover hold-down clamps, orange, S/B & B/B V6/90° thru '86  
 F. 141-601\*\*Chevy Bowtie valve cover mini nuts, orange, S/B & B/B V6/90° thru '86

\*\*Packaging contains 4 pcs. Order 2 packages per engine.

#### Carbon Style Kit

Charcoal colored carbon fiber is one of the most popular materials used in manufacturing today because of its strength and attractive looks. Proform's new Carbon-style engine dress-up products are stamped steel parts with a carbon fiber patterned film adhered to the exterior surface giving the parts that look customers crave at a reasonable price with the strength of steel.

141-710..... Full Kit. Includes one set of tall valve covers, an air cleaner kit, and a 3" breather cap

#### Parts available separately

- A. 141-712 .. Chevy Bowtie, carbon-style, valve covers, tall with baffle, Chevy S/B  
 B. 141-713 .. Chevy 14" Classic, carbon-style air cleaner kit with Bowtie center nut  
 C. 66013..... Carbon-style push-in air breather cap, 3"\*

\*Product is legal only for off-highway use (except in CA or states that have adopted CA emission standards), racing use or for use on pre-emission-controlled motor vehicle/engines (pre-1966 domestic vehicles certified to CA standards, pre-1968 domestic vehicles certified to federal standards and all pre-1968 foreign vehicles), per manufacturer's application guide.



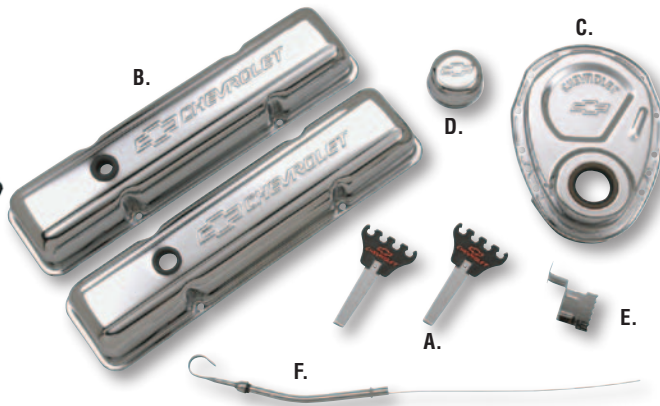

**Chevrolet® Small-Block Dress-Up Kits**

For Chevrolet® small-block V8, 1958-86. Includes two short baffled Bowtie Emblem valve covers, plus Bowtie Emblem timing chain cover with GM production oil seal installed, two black/red Bowtie 4-wire looms, one Bowtie push-in air breather, oil dipstick, timing tab for 8" Balancer, and two grommets (air breather cap and PCV)

- 141-001..... Dress-Up Kit w/ timing cover  
 Parts available separately  
 A. 141-636 .... Wire looms  
 B. 141-102 .... Valve covers, short, with baffle  
 C. 141-215 .... Timing chain cover, S/B, '69-91  
 D. 141-616 .... Breather cap, push-in, 3" dia.\*  
 E. 141-202 .... Timing tab, S/B, 8" dia  
 F. 141-550 .... Oil dipstick, S/B V8\*

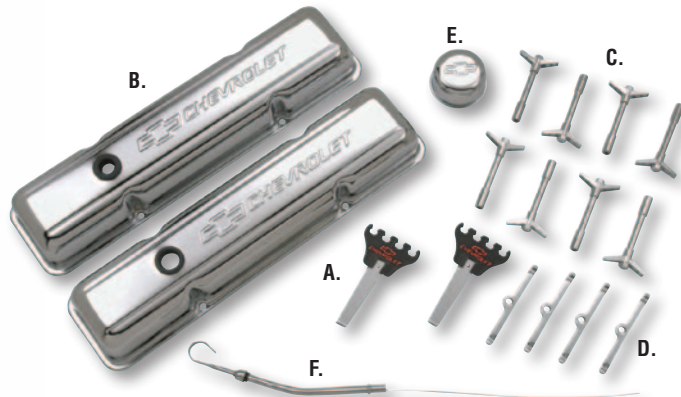
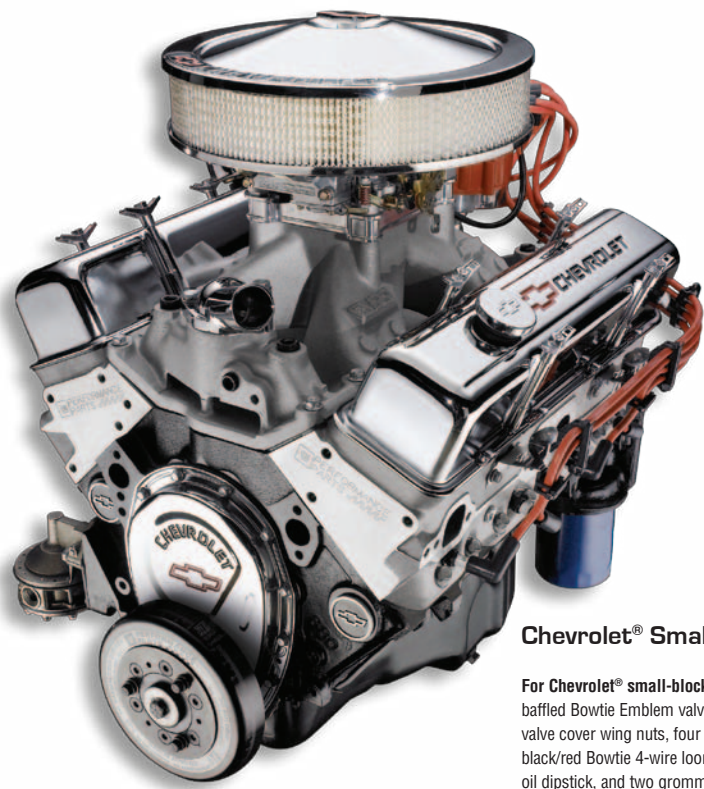

**Chevrolet® Small-Block Dress-Up Kits**

For Chevrolet® small-block V8, 1958-86. Includes two short baffled Bowtie Emblem valve covers, plus eight Bowtie Emblem valve cover wing nuts, four valve cover hold-down clamps, two black/red Bowtie 4-wire looms, one Bowtie push-in air breather cap, oil dipstick, and two grommets (air breather cap and PCV)

- 141-002..... Dress-Up Kit w/ wing nuts  
 Parts available separately  
 A. 141-636 .... Wire looms  
 B. 141-102 .... Valve covers, short, with baffle  
 C. 141-600\*\* . Bowtie valve cover wing nuts, chrome  
 D. 141-610\*\* . Hold-down clamps, chrome  
 E. 141-616 .... Breather cap, push-in, 3" dia.\*  
 F. 141-550 .... Oil dipstick, S/B V8  
 \*\*Packaging contains 4 pcs. Order 2 packages per engine.

\*Product is legal only for off-highway use (except in CA or states that have adopted CA emission standards), racing use or for use on pre-emission-controlled motor vehicle/engines (pre-1966 domestic vehicles certified to CA standards, pre-1968 domestic vehicles certified to federal standards and all pre-1968 foreign vehicles), per manufacturer's application guide.



# SLANT-EDGE VALVE COVERS

Collector's Series Slant-Edge Valve Covers!

Five NEW colors to give that engine compartment a look that'll make heads spin! Raised and milled emblems provide an aggressive and modern look under the hood.

- A. 141-932....Blue, raised emblem
- B. 141-931....Red, raised emblem
- C. 141-934....Yellow, raised emblem
- D. 141-935....White, raised emblem
- E. 141-933....Green, raised emblem



- F. 141-920.... Polished, raised emblem
- G. 141-921.... Black Crinkle, raised emblem
- H. 141-922.... Chrome-raised emblem
- I. 141-923.... Metallic Gray, recessed blue/red emblem
- J. 141-924.... Chevy® Orange, raised emblem
- K. 141-925.... Cast gray crinkle, raised emblem
- L. 141-927.... Polished, recessed red/black emblem
- M. 141-928.... Black Crinkle, recessed red emblem
- N. 141-930.... Chrome, recessed red/black emblem
- 141-926.... Polished, no emblem (not shown)
- O. 141-939.... Powdercoat-ready, raised emblem

Innovative mold design results in a die-casting with generous internal clearance.

Ten choices, with raised or recessed Chevrolet and Bowtie Emblems for a totally personalized look. Tall, with a removable baffle. Grommets included. Sold in Pairs. U.S. Pat. D580,954

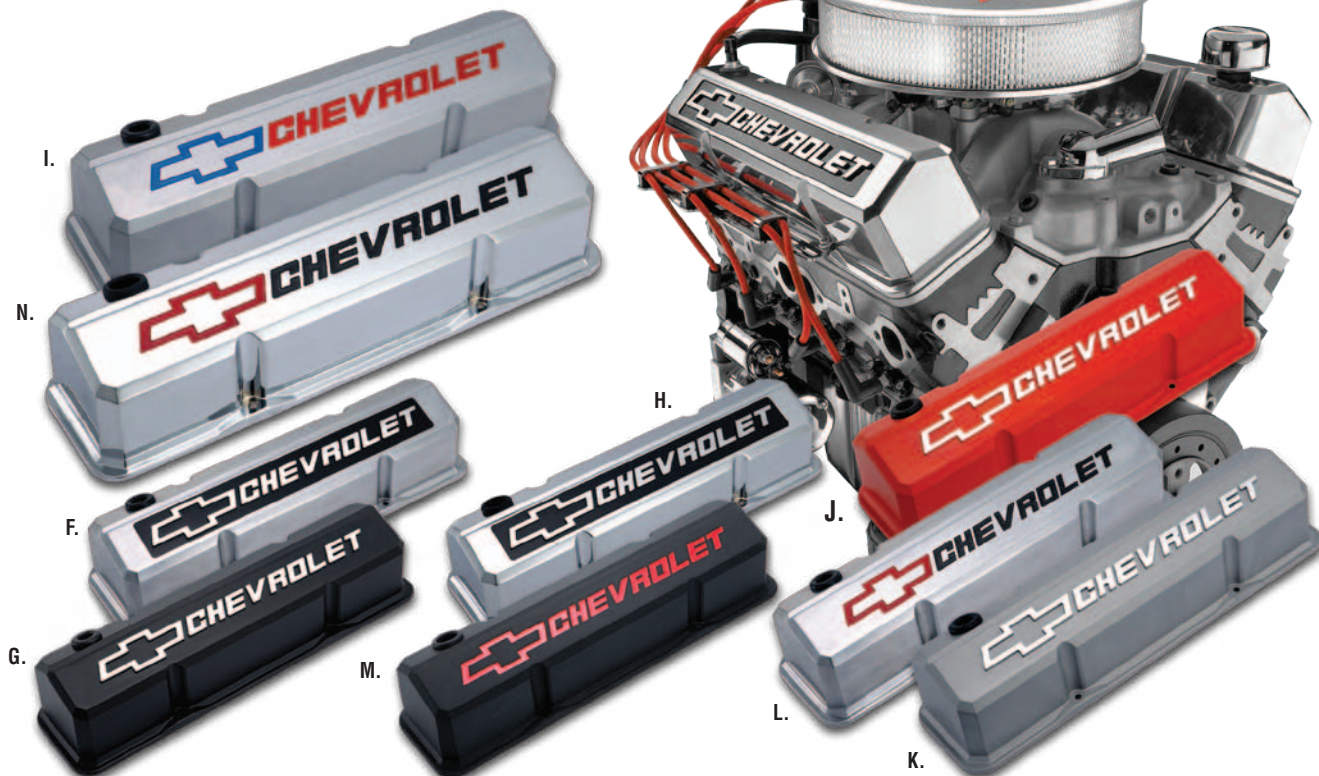



### Stamped Steel, Chevy small-block valve covers

These CHEVROLET Bowtie valve covers are made of heavy-gauge steel, 20% thicker than typical aftermarket valve covers, greatly reducing the likelihood of leakage around the valve cover flange area caused by fasteners being over-torqued. The chrome plating meets GM quality specifications. All valve covers bear the powerful Bowtie and CHEVROLET Emblems.

Black crinkle valve covers, with their distinctive look and boldly striking Bowtie and CHEVROLET Emblems, inlaid with classic Chevrolet red, are CED painted for long-term corrosion resistance, and then black crinkle painted on the outer surface.

Stamped valve covers are offered in either tall or production height (short). Oil restricting baffles are offered in many valve covers for those who wish to maintain the PCV hookup. All valve covers are sold in pairs, equipped with air breather and PCV grommets, unless specified otherwise. All valve covers with baffle come with baffle and grommets.

**Technical Note:** Production height Chevy small-block valve covers and valve covers with baffles will not clear most stud girdle applications. "Chevy small-block" or "S/B" refers to 1958-1986 engines.

#### Stamped Steel, Chevy small-block

##### Chrome:

- 141-101 .... Chrome, S/B, tall, no baffle (not shown)
- A. 141-102 .... Chrome, S/B, short, with baffle
- B. 141-103 .... Chrome, S/B, tall, with baffle
- C. 141-899 .... Chrome, S/B, short, with baffle, black lettering, red Bowtie Emblem, (not shown)
- D. 141-905 .... Chrome, S/B, tall, with baffle, black lettering, red bowtie emblem

##### Black Crinkle:

- E. 141-751 .... Black crinkle, S/B, tall, with baffle
- 141-750 .... Black crinkle, S/B, short, with baffle (not shown)

##### Metallic Gray:

- F. 141-361 ..... Metallic gray, S/B, tall, with baffle

##### Chevy Orange:

- G. 141-784 .... Chevy orange, S/B, tall, with baffle

##### Carbon-Style:

- J. 141-712 .... Carbon-Style, S/B, tall, with baffle



### Super-Light, Fabricated Aluminum Valve Covers

These precision-welded fabricated aluminum valve covers are offered in two designs: For racing with no holes, and for street (where permitted) with the traditional 1.22" hole and GM-designed baffle. They have recessed Bowtie and CHEVROLET Emblems, inlaid with classic Chevrolet red, billet mounting rails for maximum leak resistance, and weigh approximately 3 lbs (45%) less than stamped steel die-cast pairs! All valve covers come with grommets. Sold in pairs.

For Chevy® small-block V8, 1958-86

##### Black Anodized:

- H. 141-802 .... Fab aluminum, S/B, tall, black, no baffle



H.

Carbon Style



## Die-Cast Aluminum, Chevy small-block valve covers

These premium valve covers are die-cast aluminum, manufactured to GM specifications, equipped with internal oil drippers (small-block only) and GM-designed baffles. These valve covers will be available with raised and milled Bowtie and Chevrolet Emblems in addition to the traditional recessed emblems with red and/or black inlaid paint. All valve covers are Tall and equipped with with removable baffles and grommets. Sold in pairs

### Die-Cast Aluminum, Chevy small-block

#### Chrome:

A. 141-117 .... Chrome plated, recessed emblems

#### Black Crinkle:

B. 141-116 .... Black crinkle, recessed emblems

C. 141-119 .... Black crinkle, raised emblems

#### Polished:

D. 141-108 .... Polished, recessed emblems

#### Chevy Orange:

E. 141-118 .... Chevy orange, recessed emblems, with black lettering and bowtie emblem

F. 141-120 .... Chevy orange, raised emblems

#### Carbon-Style:

G. 141-121 .... Carbon-style, recessed emblems, with red lettering and bowtie emblem

## 2-Piece Die-Cast Aluminum Chevy small-block

2-Piece valve covers with the popular CHEVROLET and Bowtie Emblems.

Now you can easily check your valve train while the engine is running. The diagonal cut of the top section ensures no mess. Each valve cover features oversize bolts for fast removal, a top and bottom section, and a retained gasket for a tight seal.

Will clear roller rockers and stud girdles and available in six choices. Comes with required Allen wrench. Removable OEM style baffle. Tall. All valve covers come equipped with baffle and grommets. Sold in pairs.

Chevy small-block fits 1958 to 1986 engines. U.S. Pat. Nos. 7,343,890, D543,998S

**Technical Note:** Will not fit cylinder head 12340034 or similar (with three rectangular raised internal sections near the valve cover mounting surface), unless such sections are milled off.

### Die-Cast Aluminum, Chevy small-block

#### Chrome:

141-912.....2-Piece, chrome, S/B, tall, recessed emblem

#### Black Crinkle:

H. 141-911 .....2-Piece, black crinkle, S/B, tall, recessed emblem

I. 141-914 .....2-Piece, black crinkle, S/B, tall, raised emblem

#### Polished:

J. 141-910.....2-Piece, polished, S/B, tall, recessed emblem

K. 141-913 .....2-Piece, polished, S/B, tall, raised emblem

L. 141-915 .....2-Piece, polished, S/B, tall, no emblem

#### Accessories:

141-916.....2-Piece valve cover replacement gasket kit (2) (not shown)

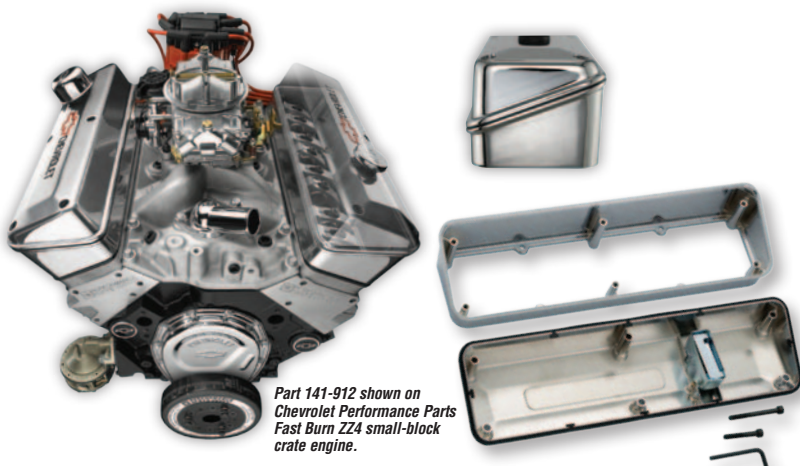

Part 141-912 shown on Chevrolet Performance Parts Fast Burn ZZ4 small-block crate engine.





# SLANT-EDGE VALVE COVERS

The Slant-Edge design comes to Chevy small-block center bolt valve covers!

**NOW AVAILABLE!** The center bolt family of valve covers now can enjoy the wildly popular Slant-Edge look that Gen 1 and LS enthusiasts have been enjoying. Generous internal clearance and raised/recessed emblems are the distinctive features of this new valve cover. Initially, seven choices will be released with raised or recessed Chevrolet and Bowie Emblems, or no emblems at all for a completely customized look. Tall, with removable baffle. Grommets, and mounting bolts included. Sold in pairs. U.S. Pat. D727,362

- A. 141-840.....**NEW!** Black crinkle, raised emblem
- B. 141-841.....**NEW!** Chevy® orange, raised emblem
- C. 141-842.....**NEW!** Cast gray crinkle, raised emblem
- D. 141-843.....**NEW!** Polished, recessed red/black emblem
- E. 141-844.....**NEW!** Chrome, recessed red/black emblem
- F. 141-845.....**NEW!** Black crinkle, recessed red emblem
- G. 141-846.....**NEW!** Polished, no emblem



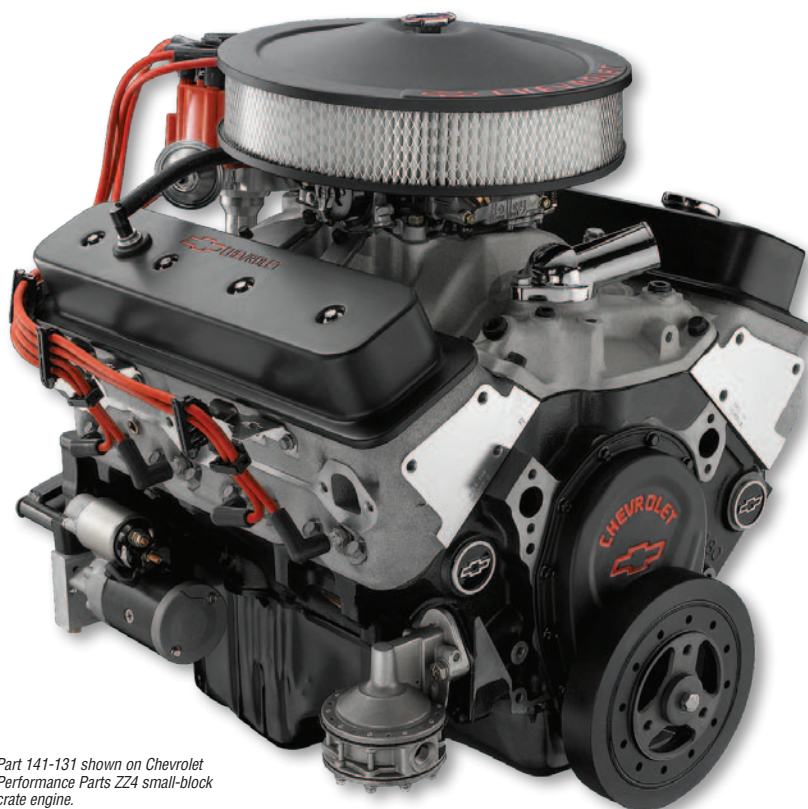

Part 141-131 shown on Chevrolet Performance Parts ZZ4 small-block crate engine.

### Die-Cast Aluminum, Chevy small-block center bolt

Center hold-down. Tall. Supplied with mounting bolts, stainless steel & rubber washers (also available separately below as 141-133). All valve covers with baffle come with baffle and grommets. S/B, '87-Pre LS. Sold in pairs.

#### Chrome:

A. 141-132 .... Center hold-down, chrome, S/B with baffle

#### Black Crinkle:

B. 141-131 .... Center hold-down, black crinkle, S/B with baffle

#### Polished:

C. 141-130 .... Center hold-down, polished, S/B, with baffle

D. 141-134 .... Center hold-down, polished, no-logo, S/B, with baffle

#### Accessories:

141-133 ..... Replacement bolt & washer kit for die-cast aluminum center hold-down valve covers

### Stamped Steel, Chevy small-block center bolt

Center hold-down. Short. All valve covers come with baffles and grommets. S/B, '87-Pre LS. Sold in pairs.

#### Chrome:

141-107 .... Center hold-down, S/B, '87-current, short, with baffle, chrome, (not shown)

E. 141-105 .... Center hold-down, S/B, '87-current, tall, with baffle, chrome

#### Black Crinkle:

F. 141-907 ..... Center hold-down, S/B, '87-current, short, with baffle, black crinkle

#### Metallic Gray:

141-908 .... Center hold-down, S/B, '87-current, short, with baffle, metallic gray (not shown)



A.



B.



C.



D.



E.



F.



## Stamped Steel, Chevy big-block valve covers

These CHEVROLET Bowtie valve covers are made of heavy-gauge steel, 20% thicker than typical aftermarket valve covers, greatly reducing the likelihood of leakage around the valve cover flange area caused by fasteners being over-torqued. The chrome plating meets GM quality specifications. All valve covers bear the powerful Bowtie and CHEVROLET Emblems.

Black crinkle valve covers, with their distinctive look and boldly striking Bowtie and CHEVROLET Emblems, inlaid with classic Chevrolet red, are CED painted for long-term corrosion resistance, and then black crinkle painted on the outer surface.

Stamped valve covers are offered in either tall or production height (short). Oil restricting baffles are offered in many valve covers for those who wish to maintain the PCV hookup. All valve covers are sold in pairs, equipped with air breather and PCV grommets, unless specified otherwise. All valve covers with baffle come with baffle and grommets.

**Technical Note:** Production height Chevy valve covers and valve covers with baffles will not clear most stud girdle applications. "Chevy big-block" or "B/B" refers to 1965-1996 engines, unless otherwise specified.

### Chrome:

- A. 141-114.....Chrome, B/B, short, with baffle
- B. 141-115 ....Chrome, B/B, tall, with baffle
- C. 141-812 ....Chrome, B/B, short, with baffle, black lettering, red Bowtie Emblem
- D. 141-813.....Chrome, B/B, tall, with baffle, black lettering, red Bowtie Emblem

### Black Crinkle:

- E. 141-811 ....Black crinkle, B/B, tall, with baffle
- 141-810 ....Black crinkle, B/B, short, with baffle (not shown)

### Chevy Orange:

- F. 141-789.....Chevy® orange, B/B, short, with baffle
- G. 141-787....Chevy® orange, B/B, tall, with baffle

## Die-Cast Aluminum, Chevy big-block valve covers

These premium valve covers are die-cast aluminum, manufactured to GM specifications, equipped with GM-designed baffles. They have recessed Bowtie and CHEVROLET Emblems, inlaid with classic Chevrolet red. All valve covers come with baffles and grommets. Sold in pairs

### Chrome:

- A. 141-140 ....Chrome, B/B, tall, with baffle

### Black Crinkle:

- B. 141-141 ....Black crinkle, B/B, tall, with baffle

### Polished:

- C. 141-142 ....Polished, B/B, tall, with baffle



A.



B.



C.

### Valve Cover Hold-Down Clamps

By spreading the load over a wider area, these clamps minimize distortion of the valve cover flanges, thereby decreasing the possibility of oil leakage. Fits Stamped Valve Covers Chevrolet small-block V8 and V6/90° engines through 1986. 4 per package.

- 141-782..... Hold-down clamps, Chevy® orange
- 141-610..... Hold-down clamps, chrome (not shown)
- 141-757..... Hold-down clamps, black crinkle
- 141-366..... Hold-down clamps, metallic gray
- 141-903..... Hold-down clamps, chrome, red Bowtie



### Air Breather Caps \*

The top of each air breather cap is embossed handsomely with a raised Bowtie Emblem to match the genuine factory-parts appearance of the engine. For use in valve covers with grommets fitting 1.22" holes. **Technical Note:** Use with grommet in Grommet Set PROFORM P/N 141-615.

- 141-616..... Push-in, 3" dia., chrome
- 141-754..... Push-in, 3" dia., black crinkle
- 141-365..... Push-in, 3" dia., metallic gray (not shown)
- 141-786..... Push-in, 3" dia., Chevy orange

For use in valve covers with grommets fitting 1.22" holes.

**Technical Note:** Use with grommet in Grommet Set PROFORM P/N 141-615.

- 141-619..... Push-in, rectangular

For use with oil filler tube (PROFORM P/N 66020) or 1.82 opening.

- 141-617..... Push-on, 3" dia.

For use with Chevrolet style holes. **Technical Note:** Manufactured with non-asbestos gaskets. It may be necessary to remove one gasket for proper clearance.

- 141-618..... Twist-on, 3" dia.

These popular push-in filter air breathers, with the raised Bowtie Emblem stamped prominently in the top, are offered in two styles: with the heat-shield hood and without. 3" diameter. Fits valve covers with 1.22" holes.

- 141-621..... Push-in, filter, with hood, chrome
- 141-622..... Push-in, filter, without hood, chrome
- 141-625..... Clamp-on, filter, with hood, 1 3/8", chrome (not shown)
- 141-613..... **NEW!** Push-in, with hood, black crinkle
- 141-614..... **NEW!** Push-in, without hood, black crinkle



### Water Necks

These Chevrolet water necks utilize neoprene O-ring gaskets instead of regular gaskets eliminating leakage. Supplied with chrome bolts. **Technical Note:** For replacement O-ring, order PROFORM P/N 66610.

- 141-500..... V8 1955-'65; Chevy II V8 '64; Corvette '56-63
- 141-501..... Chevrolet, Camaro, & Chevelle V8s '66-75



### Valve Cover Wing Nuts

The Bowtie Emblem is cut sharply into the top of each wing nut. The lower ends of the shafts are manufactured with wide shoulders for broad load distribution, and each wing nut is supplied with a separate stud which permits precise gasket positioning on the head prior to mounting the valve covers. Fits Chevrolet small and big block, and V6. 1/4" x 20 threads. 4 per package.

- 141-600..... Wing nuts, chrome
- 141-756..... Wing nuts, black crinkle
- 141-364..... Wing nuts, metallic gray
- 141-902..... Wing nuts, chrome, red Bowtie



### Valve Cover Mini Nuts

These custom valve cover mini nuts feature a Bowtie Emblem on the top of each fastener. Separate studs are included for precise gasket positioning. The wing nuts fit Chevrolet Big-Block, Small-Block, and V-6 cylinder heads. Sold 4 per package.

- 141-601..... Chevy orange
- 141-917..... Polished aluminum
- 141-367..... Metallic gray
- 141-759..... Black crinkle
- 141-909..... Chrome, with red Bowtie



### Fuel Pump Block-Off Plates

For use on Chevrolet V8s. Stamped with the handsome Chevrolet Bowtie, these plates are supplied with special non-asbestos gaskets.

- 141-210..... Chrome, S/B
- 141-211..... Chrome, B/B
- 141-212..... Black crinkle, S/B
- 141-213..... Black crinkle, B/B

**NEW!**



### Oil Dipsticks Kits

Available for a wide selection of popular Chevrolet small and big block engines, these kits consist of both the stick and the tube. The sticks have classic hook handles with the Bowtie Emblem stamped near the fill indicator mark.

- 141-550..... S/B V8 thru 1977
- 141-551..... S/B V8 1978-81
- 141-553..... B/B V8 1965-91



\*Product is legal only for off-highway use (except in CA or states that have adopted CA emission standards), racing use or for use on pre-emission-controlled motor vehicle/engines (pre-1966 domestic vehicles certified to CA standards, pre-1968 domestic vehicles certified to federal standards and all pre-1968 foreign vehicles), per manufacturer's application guide.



## SLANT-EDGE AIR CLEANERS

A NEW Slant-Edge Air Cleaner to match our wildly popular Slant-Edge Valve Covers. NEW Slant-Edge Air Cleaners are the perfect way to complete your dress-up look in premium Slant-Edge style. Whether you have Slant-Edge valve covers, or a set from a different series, these air cleaners will bring your engine look together in head turning fashion. They are supplied with genuine 3" GM air filter elements (GM P/N 6421746, AC Delco P/N A212CW) for maximum airflow. Each kit is supplied with necessary mounting hardware. Technical Note: After installing a new air cleaner, always lower the hood slowly to confirm sufficient clearance visually. Minimum clearance of 3-3/4" is required from the top of the carburetor gasket area to the underside of the hood. For buyers wishing a taller (4-1/32") filter, purchase GM P/N 8997189 (AC P/N A697C). The air cleaner bases are recessed for a low profile appearance, maximum performance and hood clearance. Patent Pending.

**NEW!** 141-830....Black Crinkle, raised emblem

**NEW!** 141-831....Chevy® Orange, raised emblem

**NEW!** 141-832....Cast Gray Crinkle, raised emblem

**NEW!** 141-833....Polished, recessed red/black emblem

**NEW!** 141-834....Black Crinkle, recessed red emblem

**NEW!** 141-835....Chrome, recessed red/black emblem



Slant-Edge Air  
Cleaner Attaches with Threaded Boss  
on Bottom Side



## Stamped Steel Air Cleaners

These air cleaner kits are offered in two styles, the "classic," which reflects many years of GM air cleaner styling, and the newer "high-performance" look. They are equipped with the CHEVROLET Emblem, and they are supplied with genuine GM (AC) air filter elements for maximum airflow. Both the tops and the bases have matching finishes (except carbon-style), and each kit is supplied with necessary mounting hardware. The classic air cleaner kits are supplied with special die-cast Bowtie center nuts (except 141-906) (also offered separately). The 14" air cleaner kits are supplied with 3" tall filter GM P/N 6421746 (AC P/N A212CW). For buyers wishing a taller (4-1/32") filter, purchase GM P/N 8997189 (AC P/N A697C). The bases of the 14" air cleaner kits are recessed for a low profile appearance, maximum performance and hood clearance.

**Technical Note:** After installing a new air cleaner kit, always lower the hood slowly to confirm sufficient clearance visually. Minimum clearance of 3-3/4" is required from the top of the carburetor gasket area to the underside of the hood.

A. 141-906 .... 14" Classic, chrome, bowtie center nut not included.

B. 141-752 .... 14" Classic, black crinkle

C. 141-713 .... 14" Classic, carbon-style

(Note: This is a stamped steel air cleaner lid with a carbon fiber design)

D. 141-785 .... 14" Classic, Chevy® orange

E. 141-302 .... 14" Classic, chrome with embossed emblem

F. 141-307 .... 14" High-performance

141-315 .... 10" High-performance (not shown)

G. 141-362 .... 14" Classic, metallic gray

A.



B.



C.



D.



E.



F.



G.

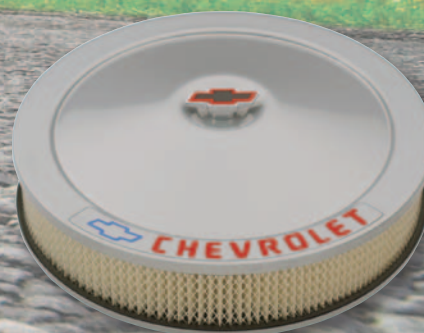

## Air Cleaner Nuts

Available with the distinctive GM and Chevrolet Bowtie Emblems, these zinc die-cast air cleaner center nuts are offered in three popular styles, in both large and small sizes. The large size is recommended for 14" and 10" air cleaner kits, and the small for smaller air cleaner kits. They fit both 1/4"-20 and 5/16"-18 studs.



141-369.....Large black crinkle Bowtie Center Nut



Large: 141-333  
Small: 141-322



Large: 141-323  
Small: 141-328



Large: 141-327  
Small: 141-332



## Aluminum and Carbon Air Cleaners

SAVE critical front-end pounds! PROFORM offers you a choice of five race-winning combinations: air cleaner lids ranging from genuine carbon-fiber to aircraft aluminum, with or without the famous Bowtie and CHEVROLET® Emblems, in black or clear-anodized finishes; plus a 3" tall genuine AC filter (AC P/N A212CW); plus a color-matched, super-deep aluminum base for maximum hood clearance when using optional, extra tall air filter elements. These weight-saving high-performance air cleaner kits blend traditional OEM appearance profiles with optimized air-flow dynamics to achieve checkered-flag results. Supplied with necessary mounting hardware and center nuts as shown.

141-692.....14" Black aluminum, Bowtie, Chevrolet Emblem

141-690.....14" Black aluminum, no logo

A. 141-693 ....14" Clear anodized aluminum, Bowtie, Chevrolet emblem

141-691.....14" Clear anodized aluminum, no logo

B. 141-790 ....14" Classic, black, genuine carbon fiber, air cleaner kit



A.



All Super-Light Air Cleaners Come with a Deeply Recessed Aluminum Base! Available Separately as PN 66808, or 66810



B.

## Timing Chain Covers

For use on Chevrolet small-block V8 1969-91 and V6/90° engines, with CHEVROLET & Bowtie Emblems. Engineered to GM standards for reliable installation, these stamped steel covers are supplied with a GM production oil seal installed, and are direct replacements for all late model stamped small-block and V6/90° front covers that use bolt-on timing pointers.

Black crinkle timing cover offers a distinctive look and boldly striking Bowtie and CHEVROLET Emblems, inlaid with classic Chevrolet red. It provides an award-winning total look when used with a black crinkle air cleaner and valve covers.

**Technical Note:** Replacement oil seal: GM P/N 10111769.

A. 141-215 ....S/B, '69-91, chrome

B. 141-753 ....S/B, '69-91, black crinkle

C. 141-904 ....S/B, '69-91, chrome, red Bowtie, black CHEVROLET

D. 141-783 ....S/B, '69-91, Chevy orange

141-363 ....S/B, '69-91, metallic gray, blue Bowtie, red CHEVROLET (not shown)

For use on Chevrolet big-block, 1965-90 with Chevrolet & Bowtie Emblems. Replacement oil seal: GM P/N 3860095.

E. 141-216 ....B/B, '65-90, chrome

Striking die-cast timing covers, supplied with separate GM production oil seal. Bowtie Emblem directly cast into the upper surface.

F. 141-217.....S/B, '69-91, polished

141-218 ....S/B, '69-91, chrome plated, (not shown)

## Timing Chain Pointers

For Chevrolet small-block V8 or V6/90°, with 6-3/4" or 7" balancer, 1969-90; or with 8" balancer, 1969-91.

**Technical Note:** May be used for some pre-'69 engines by relocating top dead center on the balancer.

141-200.....S/B, 6-3/4" or 7"

141-202.....S/B, 8"

For Chevrolet big-block with 8" balancer, 1965-'91.

141-201.....B/B, 8"



A.



B.



E.



C.



D.



F.

### Master Cylinder Covers

These GM dual line master cylinder covers are offered for the most popular applications. Supplied with clips and a precisely positioned GM Emblem. PDB = Power Disk Brakes.

**141-225.....Single clip, 5-3/4" x 3", PDB**

**141-227.....Single clip, 5" x 2-3/8", PDB or manual**



### Transmission Oil Pan

The large GM Emblem is stamped prominently onto this finned pan for maximum visibility. Stock-pan depth. Chrome drain plug makes it easier to change the fluid and filter.

**141-250..... Turbo 350**



### Push-In Oil Filler Cap

Chevrolet Bowtie embossed and raised on top. For valve covers with 1.22" diameter hole.

**141-630.....Chrome**

**141-629.....Black crinkle**



### Twist-On Oil Filler Cap

This large oil filler cap has a large white-on-blue epoxy-coated GM Emblem in the center. For Chevrolet style holes. Manufactured with a non-asbestos gasket.

**141-631.....Oil filler cap**



### Linear Wire Looms

Using the valve cover mounting bolts, these handsome Bowtie looms are positioned along the valve cover to hold the wires in a neat parallel arrangement. The epoxy-coated Bowtie Emblem is centrally located for maximum visibility. The wire holders are opened and closed individually with a patented nylon wedge to permit the tops to have a smooth surface free of screw holes. The wire holders will accommodate wires up to 8 mm in diameter. Manufactured under U.S. design patents 298,798 and 284,262 and 311,487. 1 pair per package. Technical Note: Before purchasing, check exhaust manifold for correct usage. For clearance reasons, the manifold must not be much higher than the valve cover mounting flanges.

**141-638.....S/B V8, 1959-86, Chrome**

**141-714.....S/B V8, 1959-86, Black Crinkle**

**141-639.....B/B, 1965-91, Chrome**



### Bowtie Emblem Freeze Plug Inserts

Give your engine block the ultimate trick look with PROFORM's machined billet aluminum Bowtie Emblem Freeze Plug Inserts.

Choose from either the popular recessed emblem or the new black with raised emblem. Fits all Chevy small block engines except LS-series.

**Technical Note:** This is not a freeze plug replacement.

**141-233.....Bowtie emblem freeze plug Inserts with recessed red emblem, 2 per pkg.**

**141-232.....Bowtie emblem freeze plug Inserts with raised emblem, black, 2 per pkg.**



### Ignition Wire Looms

Using the divisional red color, the CHEVROLET and Bowtie Emblem are molded onto the black nylon head of each wire loom, mounted on chrome stems. Fits Chevrolet small-block V8 1958-'86 and Chevrolet big-block V8 1965-'91. 4-wire looms, 2 per package.

**141-636.....Wire Looms**



### Harmonic Balance Covers

These patented harmonic balancer covers offer improved readability, more stable Top Dead Center indication and timing accuracy, enhanced appearance for a previously ignored underhood area, and the elimination of timing tapes which are inevitably flung off. They are available in chrome and black, resulting in parts with the appearance of \$200 balancers.

Each cover is distinctively marked with the famous Bowtie Emblem, Top Dead Center and the proper timing degrees. Using this cover improves timing accuracy because over time the etched outer inertia ring of a typical harmonic balancer may slip in relation to the center hub of the balancer, causing the etched markings to provide an inaccurate indication of Top Dead Center for the #1 piston. Mounted directly through the center hub, this cover eliminates the affect of any outer inertia ring slippage. Aluminum. U.S. Patent 5,675,078.

**6-3/4" Chevy® small-block**

**141-727.....Black**

**141-725.....Chrome**

**8" Chevy® small-block**

**141-728.....Black**

**141-726.....Chrome**

**Chevy® big-block**

**141-730.....Black**

**141-729.....Chrome**



### Grommet Set

One for push-in air breather and one for PCV valve.

**141-615.....Grommet set**





## Bowtie Emblem Adjustable Reinforced Aluminum Rear End Differential Covers

Reduce deflection under heavy torque loads with a lightweight aluminum differential cover.

Expand the popular black crinkle look to your rear axle with a reinforced differential cover looks great and upgrades performance. The Bowtie Emblem is prominently displayed with a precision CNC milled finish. Each cover includes two adjustable bolts to stabilize bearing main caps, fluid capacity and magnetic drain plugs, and mounting bolts. All covers have a durable black crinkle finish.

- A. **NEW!** 141-695.....GM, 7.5 (10 Bolt)
- B. **NEW!** 141-696.....GM, 8.2/8.5 (10 Bolt)
- C. **NEW!** 141-697.....GM, 12 Bolt, Passenger Car



A.



C.



B.

## Electric Water Pumps - Chevy Small Block

Eliminates unnecessary weight and impeller-drag experienced at high RPM, pumps up to 35+ gallons of water per minute, and delivers the cooling that can make the difference between a win and second place! Durable but light-weight die-cast aluminum, epoxy powder coated for corrosion resistance in the color of your choice. Each unit comes with the popular Chevy Bowtie Emblem in red. Race or street. Comes with FREE inlet fitting (1" pipe to 1 3/4" hose) and mating weather-tight connector.

- A. 141-653 .... Chevy S/B Bowtie electric water pump, blue
- B. 141-651 .... Chevy S/B Bowtie electric water pump, black
- C. 141-652 .... Chevy S/B Bowtie electric water pump, red
- D. 141-650 .... Chevy S/B Bowtie electric water pump, chrome
- E. 141-655 .... Chevy S/B Bowtie electric water pump, Chevy Orange
- 141-654 .... Chevy S/B Bowtie electric water pump, polished (not shown)



## Electric Water Pumps - Chevy Big Block

- A. 141-670 .... Chevy B/B, Bowtie Emblem, electric water pump, polished
- B. 141-671 .... Chevy B/B, Bowtie Emblem, electric water pump, chrome
- C. 141-672 .... Chevy B/B, Bowtie Emblem, electric water pump, red
- D. 141-673 .... Chevy B/B, Bowtie Emblem, electric water pump, blue
- E. 141-674 .... Chevy B/B, Bowtie Emblem, electric water pump, black
- F. 141-675 ..... Chevy B/B, Bowtie Emblem, electric water pump Chevy Orange

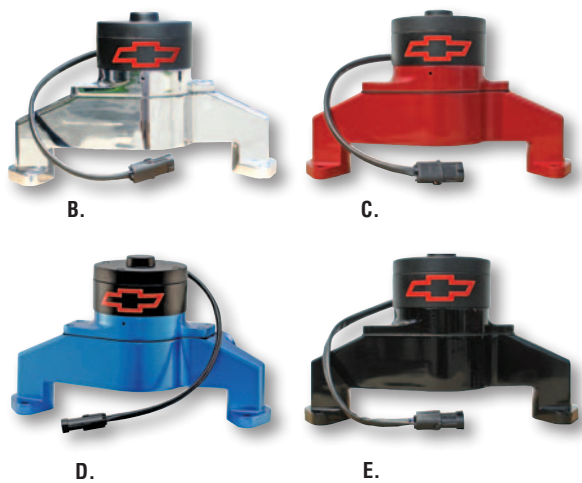



## Setting a New Standard in Ignition!\*

Validated harness and capacitor for reliable energy flow

Low-friction cam with super-smooth, gradual, tight-tolerance TIR (Total Indicated Runout) deviation from datum line

Sintered steel weights for lighter weight while withstanding 270 newtons min. for maximum durability

Adjustable vacuum advance for fine tuning the rate and amount of advance that will result in increased power and eliminate harmful detonation

Weight springs made with stress-relieved music wire to assure blueprinted advance curve

High-performance module engineered with low saturation for maximum spark intensity

These premium distributors include: Genuine Chevrolet Performance Parts melonized gears, which are "required on all Chevrolet Performance crate engines, or serious damage will occur."



141-681..... Yellow cap HEI Distributor with Coil



141-682..... Black cap HEI Distributor with Coil



141-683..... Red cap HEI Distributor with Coil

\*Product is legal only for off-highway use (except in CA or states that have adopted CA emission standards), racing use or for use on pre-emission-controlled motor vehicle/engines (pre-1966 domestic vehicles certified to CA standards, pre-1968 domestic vehicles certified to federal standards and all pre-1968 foreign vehicles), per manufacturer's application guide.



### Heavy Duty High-Torque Mini Starter

High torque, gear reduction design. 100% new, not rebuilt. Offset design results in more clearance between the oil pan and the starter, and can be rotated for additional chassis clearance. 15-to-1 compression for maximum cranking!

141-684..... Heavy-duty, 2.0 KW starter



### 100% New Chrome Alternators

It is now possible to obtain four sought-after and popular features in one alternator! 100% NEW with absolutely no re-built components. Assured quality with generous, over-spec amperage, a machined pulley, and the popular Chevy Bowtie Emblem in red. Each unit is supplied with its own individual Quality Assurance graph documenting its operating performance. For a new level of functionality, insist on these 100% new Bowtie alternators!

141-656.....GM Bowtie Emblem '73-'86 internal regulator

141-657.....GM Bowtie Emblem 100 AMP, 1-wire

141-658.....GM Bowtie Emblem 60 AMP, 1-wire

141-659.....GM Bowtie Emblem 80 AMP, 1-wire

141-660.....GM Bowtie Emblem 120 AMP, 1-wire



### Alternator Brackets

Made of heavy steel and offered for the most popular Chevrolet small block V8 applications, these brackets become a very noticeable addition to every chrome-accessorized engine.

A. 141-402 .... Top bracket bolts to manifold

### Billet Aluminum Keychain

141-970.... Chevrolet Bowtie Keychain



### 15-Inch Electric Fans with Thermostat

Your stock fan robs your engine of up to 15 or more horsepower! Replace it with a rugged, Bowtie Emblem, universal-fit fan equipped with an adjustable 180°-240°F thermostat. Bolts to your radiator supports using sturdy brackets. With a heavy-duty motor, highly angled blades, and 15" diameter, this unit pulls up to 2,800 cfm of air, cooling engines with up to 250+ HP (without air) and 220+ HP (with air). Overall: 18" x 16-1/8" x 4". Amp draw, 14 amps.

141-647.....Bowtie 15-inch Electric Fan with thermostat



### Bowtie High Performance Electric Fans

These reversible fans help prevent overheating in stop-and-go traffic, designed to fit the most popular cars and trucks, increases gas mileage, improves engine performance, frees the waterpump pulley for more RPM, installs in minutes with simple hand tools. 10", 12", 14" and 16" fans are reversible (mounts in front or back of radiator). Ultra thin design to fit cramped locations. Reinforced glass filled polypropylene blade and plastic housing for minimized weight. Nylon tie mounting kit included. Nominal fan size is based upon approximate overall assembly diameter

A. 141-641.....10-inch Electric Fan

B. 141-642.....12-inch Electric Fan

C. 141-644.....14-inch Electric Fan

D. 141-646.....16-inch Electric Fan



A.



B.



C.



D.

Diameter	10"	12"	14"	16"
Thickness	2-1/2"	2-1/2"	4"	4"
Motor RPM	3000	3000	2500	2000
AMP Draw	7	7	8	9
Fuse Size AMP	25	25	30	30
CFM	1000	1200	1650	2100





### Ford 289-302-351W Slant-Edge Valve Covers

Turn heads with this new aggressive and modern look for your engine. As a result of innovative mold design, these die-cast valve covers offer more internal clearance for large valvetrain applications. With **11** choices available, they will provide a totally personalized look. Tall, with a removable baffle. Grommets and bolts included. Sold in pairs. U.S Pat. D670,360.

**Note:** Not for use on engines with EFI manifolds.

#### Ford RACING

- Black Crinkle, Raised emblems ..... 302-135
- Ford® Blue, Raised emblems..... 302-136
- Cast Gray Crinkle, Raised emblems..... 302-137
- Polished, Recessed black emblems ..... 302-138
- Chrome, Recessed black emblems..... 302-139

#### Ford MUSTANG

- Black Crinkle, Raised emblems ..... 302-140

#### Ford RACING Collector's Series

- Green, Raised emblems..... 302-141
- White, Raised emblems..... 302-142
- Red, Raised emblems..... 302-143
- Yellow, Raised emblems..... 302-144
- Powdercoat-Ready, Raised emblems ..... 302-146

## Ford 289-302-351W Stamped Steel Valve Covers

These affordable, high-quality stamped steel valve covers are offered in a deep chrome plated look, black crinkle, and the new carbon-style look. In addition to the classic raised Ford RACING emblem, you may choose from a new selection of recessed styles featuring the striking COBRA, MUSTANG, and RACING emblems. All valve covers include baffles and grommets. Sold in pairs.

**Note:** Not for use on engines with EFI manifolds.



### Ford RACING

Chrome, Embossed emblems .....	302-070
Black Crinkle, Red emblems .....	302-072
Chrome, Black emblems .....	302-071
Carbon-Style, Red emblems .....	302-008

### Ford MUSTANG

Black Crinkle, Red emblems .....	302-101
Chrome, Black emblems .....	302-100

### Ford COBRA

Black Crinkle, Red emblems .....	302-117
Chrome, Black emblems .....	302-116



## Ford 289-302-351W Die-Cast Aluminum Valve Covers

New Ford COBRA and Ford MUSTANG styles join the venerable Ford RACING style. These premium valve covers are "Tall", and designed to clear roller rockers and polylock nuts. They have recessed emblems with inlaid paint. All valve covers include baffles and grommets. Sold in pairs.

**Note:** Not for use on engines with EFI manifolds.

### Ford RACING

Polished, Black emblems (was M-6582-E302P) .....	302-001
Chrome, Black emblems (was M-6582-R302) .....	302-002
Black Crinkle, Red emblems (was M-6582-L302) ...	302-003

### Ford COBRA

Polished, Black emblems .....	302-055
Black Crinkle, Red emblems .....	302-056

### Ford MUSTANG

Polished, Black emblems .....	302-030
Black Crinkle, Red emblems .....	302-031



\*Except those in categories with asterisks, these products are not legal for sale or use on pollution controlled vehicles.





### NEW! Slant-Edge Air Cleaner Kits

Complete your engine look with a Slant-Edge Air Cleaner to match your valve covers. Whether you have Slant-Edge valve covers, or a set from a different series, these air cleaners will bring your engine look together in head turning fashion. The air cleaner lid does not use a traditional center nut, because it attaches to the carburetor with a threaded boss on the underside and is simply spun down into place. They are supplied with genuine Motorcraft® 2 5/8" high filter element (part no. FA-612R) for maximum airflow. Each kit is supplied with necessary mounting hardware.

Technical Note: After installing a new air cleaner, always lower the hood slowly to confirm sufficient clearance visually. Minimum clearance of 3-3/4" is required from the top of the carburetor gasket area to the underside of the hood.

The air cleaner bases are recessed for a low profile appearance, maximum performance and hood clearance. Patent Pending.

#### Ford RACING

- Black Crinkle, Raised emblems ..... **NEW!** 302-380
- Ford® Blue, Raised emblems..... **NEW!** 302-381
- Cast Gray Crinkle, Raised emblems..... **NEW!** 302-382
- Polished, Recessed black emblems ..... **NEW!** 302-383
- Chrome, Recessed black emblems..... **NEW!** 302-384
- Black Crinkle, Recessed red emblems ..... **NEW!** 302-385

## Air Cleaners

The air cleaner is one of the most visible parts on a car's engine, so now is the time to add a premium Ford RACING, MUSTANG, or COBRA emblem to your ride for the perfect customized look! These 13" diameter air cleaners fit 2V and 4V carburetors, and are supplied with a genuine Motorcraft® 2-5/8 high filter element (part no. FA-612R). The tops and bases have matching finishes (excluding Carbon-Style), and each kit is supplied with necessary mounting hardware. Classic air cleaner kits are supplied with special die-cast Ford oval center nuts (also offered separately).

**Technical Note:** After installing a new air cleaner kit, always lower the hood slowly to confirm sufficient clearance visually. Minimum clearance of 4" is required from the top of the carburetor gasket area to the underside of the hood.

## Classic Stamped Steel Air Cleaner Kits

### Ford RACING

Black Crinkle, Red emblem .....	302-352
Chrome, Embossed emblems (was M-9600-A302R).....	302-350
Chrome, Black emblem .....	302-351
Carbon-Style, Red emblem .....	302-354

### Ford COBRA

Black Crinkle, Red emblem .....	302-372
Chrome, Black emblem .....	302-371

### Ford MUSTANG

Chrome, Black emblem .....	302-361
Black Crinkle, Red emblem .....	302-362



## Air Cleaner Center Nuts\*

Add some extra flair to your custom air cleaner by topping it with a distinctive Ford or Mustang center nut available in chrome or black finishes. Fits 1/4-20 carburetor studs.

### Ford Oval

Chrome (was M-9697-A) .....	302-333
Black Crinkle .....	302-334
Black Crinkle, Red emblem .....	302-339

### Mustang Pony

Chrome (was M-9697-C).....	302-337
Black Crinkle .....	302-338



*Updated Mustang Pony Emblem!*



\*Except those in categories with asterisks, these products are not legal for sale or use on pollution controlled vehicles.





### Engine Dress-Up Kits

Give your Ford Engine a complete makeover with our new Ford RACING dress-up kits! Available in four different styles, perfect for customizing your engine and giving it that "complete look." *Note: Hold-Down clamps not shown.*

#### Deluxe Kits with recessed emblems and inlaid paint.

- Black Crinkle, Red emblems .....302-500
- Chrome, Black emblems .....302-510
- Carbon-Style, Red emblems .....302-520

#### Traditional Kit with embossed emblems

- Chrome, Embossed emblems .....302-515



**HOT LOOK!**

Carbon-Style

DRESS-UP KITS	302-500	302-510	302-515	302-520
Valve Covers	302-072	302-071	302-070	302-008
Air Cleaner	302-352	302-351	302-350	302-354
Air Breather Cap	302-216	302-215	302-215	66013
12 Mini Nuts	302-316 x3	302-315 x3	302-315 x3	-
Oil Dipsticks	-	-	302-401	-
Wire Looms	-	-	302-636	-
Hold-Downs	Included	Included	Included	Not Included

## FORD PERFORMANCE PARTS!

### NEW! Ford 289-302-351W Slant-Edge Valve Covers

The Ford Performance brand is now available on the wildly popular, patented design, Slant-Edge valve covers. Made of die-cast aluminum, with recessed and painted emblems for a nice clean look under the hood. Tall, with removable baffle. Rubber grommets, and a pair of long mounting bolts are included. Sold in pairs. U.S. Pat D670,360.

Note: **Not for use on engines with EFI manifolds.**

#### Ford PERFORMANCE

Polished, Recessed black emblems .....**NEW!** 302-148  
 Chrome, Recessed black/red emblems .....**NEW!** 302-149



## FORD PERFORMANCE PARTS!

### NEW! Ford Slant-Edge Air Cleaner Kits

Nothing complements Ford Performance emblem valve covers like a matching Slant-Edge air cleaner! Recessed and painted emblems make for a sharp and distinctive emblem in either lustrous chrome or polished aluminum. The air cleaner lid does not use a traditional center nut, because it attached to the carburetor with a threaded boss on the underside and is simply spun down into place. They are supplied with genuine Motorcraft® 2 5/8" high filter element (part no. FA-612R) for maximum airflow. Each kit is supplied with necessary mounting hardware.

Technical Note: After installing a new air cleaner, always lower the hood slowly to confirm sufficient clearance visually. Minimum clearance of 3-3/4" is required from the top of the carburetor gasket area to the underside of the hood.

The air cleaner bases are recessed for a low profile appearance, maximum performance and hood clearance. Patent Pending.

#### Ford PERFORMANCE

Polished, Recessed black emblems .....**NEW!** 302-386  
 Chrome, Recessed black/red emblems .....**NEW!** 302-387



Slant-Edge Air Cleaner Attaches with Threaded Boss on Bottom Side



\*Except those in categories with asterisks, these products are not legal for sale or use on pollution controlled vehicles.





### Oil Filler Cap\*

Screw-in oil filler cap prominently displays the Ford oval. This is a direct replacement part.

**Chrome** (was M-6766-F302)..... **302-230**



### Mini Nuts\*

High quality steel mini nuts are the perfect way to finish your engine dress-up project. Small and unobtrusive with the Ford oval cut sharply into the top. All nuts are supplied with a separate stud which permits precise gasket positioning on the head prior to mounting the valve covers. 1/4-20 threads. Does not fit FE engines. 4 per package.

**Chrome** (was M-6680-A) ..... **302-315**

**Black Crinkle** ..... **302-316**



### Air Breather Caps

The top of each air breather cap is embossed handsomely with Ford RACING, COBRA, or MUSTANG emblems. The perfect complement to your valve covers. Push-in unless noted.

#### Ford RACING

**Chrome** (twist type, not shown) (was M-6766-A302)..... **302-200**

**Chrome** (was M-6766-B302) ..... **302-215**

**Black Crinkle** ..... **302-216**

**Chrome, filter, with hood** (was M-6766-K302) ..... **302-235**

**Chrome, filter, without hood** (was M-6766-H302)..... **302-236**

**Black Crinkle, filter, with hood**..... **NEW!** 302-233

**Black Crinkle, filter, without hood** ..... **NEW!** 302-234

#### Ford MUSTANG

**Chrome** ..... **302-220**

**Black Crinkle** ..... **302-221**

#### Ford COBRA

**Chrome** ..... **302-225**

**Black Crinkle** ..... **302-226**



## Engine Oil Dipsticks\*

Don't forget the dipstick! Blue anodized aluminum handle is knurled and has the Ford Oval embossed and silver script printed prominently on the top. Fits 289-302-351W engines 1962-1978 only.

- Chrome w/ Blue anodized aluminum handle**  
 (was M-6750-B302) ..... 302-400  
**Chrome** (was M-6750-A302) ..... 302-401



## Wing Nuts\*

The Ford oval is cut sharply into the top of each wing nut. The lower ends of the shafts are manufactured with wide shoulders for broad load distribution. All nuts are supplied with a separate stud which permits precise gasket positioning on the head prior to mounting the valve covers. 1/4-20 threads. Does not fit FE engines. 4 per package.

- Chrome** (was M-6680-A302) ..... 302-325  
**Black Crinkle** ..... 302-326



## Fuel Pump Block-Off Plates\*

Finish your engine off properly with a chrome block-off plate that prominently features the Ford Oval.

- Chrome** (was M-9351-A302) ..... 302-290  
**Black Crinkle** ..... 302-291



## Billet Aluminum Keychain\*

This billet aluminum piston rod keychain is the perfect gift for the Ford enthusiast. "A little bling for your ring."

- Ford Oval Keychain** ..... 302-700



## Wire Looms and Dividers\*

Keep that mess of ignition wires under control with wire looms and dividers. 6 wire dividers per package. Wire looms sold in pairs and fit 289-302-351W engines, 5/16" bolt hole.

### Ford RACING Wire Looms

- Chrome with Blue** (was M-12297-B14) ..... 302-636  
**Chrome with Black** ..... 302-640

### Ford Oval Wire Dividers

- Blue: 2, 3, 4-wire, 2 each** (was M-12297-B02/B03/B04) ... 302-637  
**Black: 2, 3, 4-wire, 2 each** ..... 302-641

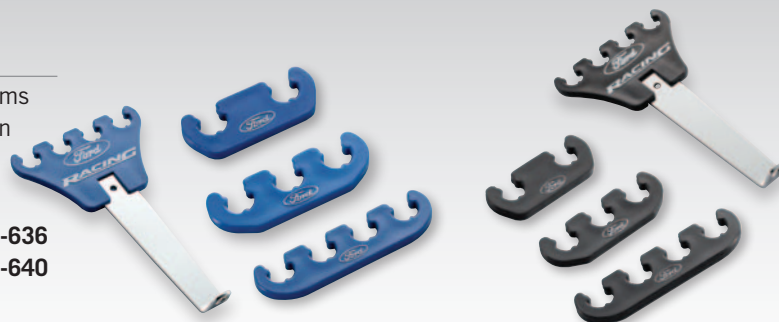

\*Except those in categories with asterisks, these products are not legal for sale or use on pollution controlled vehicles.



**PROFORM® Race Series Carburetors\***



*Finally an affordable high-performance race carburetor! PROFORM's Race Series Carburetor is hand assembled in the U.S. utilizing the PROFORM High-Flow Carburetor Main Body, durable billet metering blocks, and a high performance billet throttle baseplate.*

**The PROFORM® Race Series Carb includes:**

**PROFORM® Carburetor Main Body**

- High-Flow Aluminum Main Body!
- Dyno-Proven Horsepower & Torque Gain!
- Adjustable, Screw-In Air Bleeds!
- High-Performance Down-Leg Boosters! (except p/n 67204)
- Maximum Air Flow: No Air Horn, Choke Tower, or Choke Control!
- High-Rate Air-Flow Section Design!
- Uses standard service & tuning components!

**PROFORM® Billet Throttle Base Plates!**

- Adjustable Secondary Air Flow Cam Bracket!
- Solid Billet Construction!
- Manufactured in the U.S.A.!
- Timed and Full Vacuum Tubes for Accessories and Tuning!
- Button Torx Head Throttle Plate Screws!
- Power Valve Blow Out Protection!
- Slip Link Mechanical Secondary Linkage!
- Serviceable Throttle Levers!

**PROFORM® Billet Metering Blocks**

- Solid Billet Construction!
- Durable, No Warping or Porosity Problems!
- Changeable Idle Feed Restriction!
- Manufactured in the U.S.A.!

**PROFORM® Aluminum Fuel Bowls**

- Lightweight Aluminum
- Sight Glass Windows for easy float adjustment!

**Mechanical Secondary Race Series Carburetors**

- 67199 ..... 650 CFM Race Series Carburetor
- 67200 ..... 750 CFM Race Series Carburetor
- 67201 ..... 850 CFM Race Series Carburetor
- 67202 ..... 950 CFM Race Series Carburetor
- 67209 ..... 1050 CFM Race Series Carburetor

**Vacuum Secondary Race Series Carburetors (with adjustable secondary housing)**

- 67204 ..... 650 CFM vacuum secondary race series carburetor
- 67205 ..... 750 CFM vacuum secondary race series carburetor

**NEW BLACK RACE SERIES CARBURETORS!**

The Black Diamond® coating used on the main body and fuel bowls provides a durable finish which is impact resistant, and reduces fuel temperature by 6% based on thermal testing for enhanced performance. It is impervious to virtually all under hood chemicals and fuels, and is corrosion resistant. The black satin finish is easy to clean and gives your carburetor a great sleek look!

**Mechanical Secondary Black Race Series Carburetors**

- NEW!** 67301 ..... 650 CFM Black Race Series Carburetor
- NEW!** 67302 ..... 750 CFM Black Race Series Carburetor
- NEW!** 67303 ..... 850 CFM Black Race Series Carburetor
- NEW!** 67304 ..... 950 CFM Black Race Series Carburetor
- NEW!** 67305 ..... 1050 CFM Black Race Series Carburetor

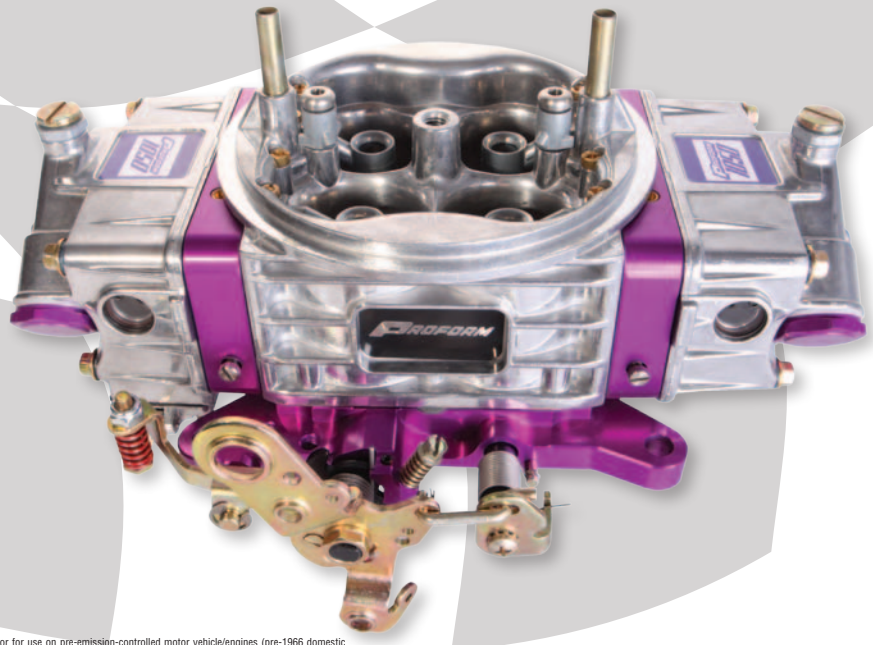
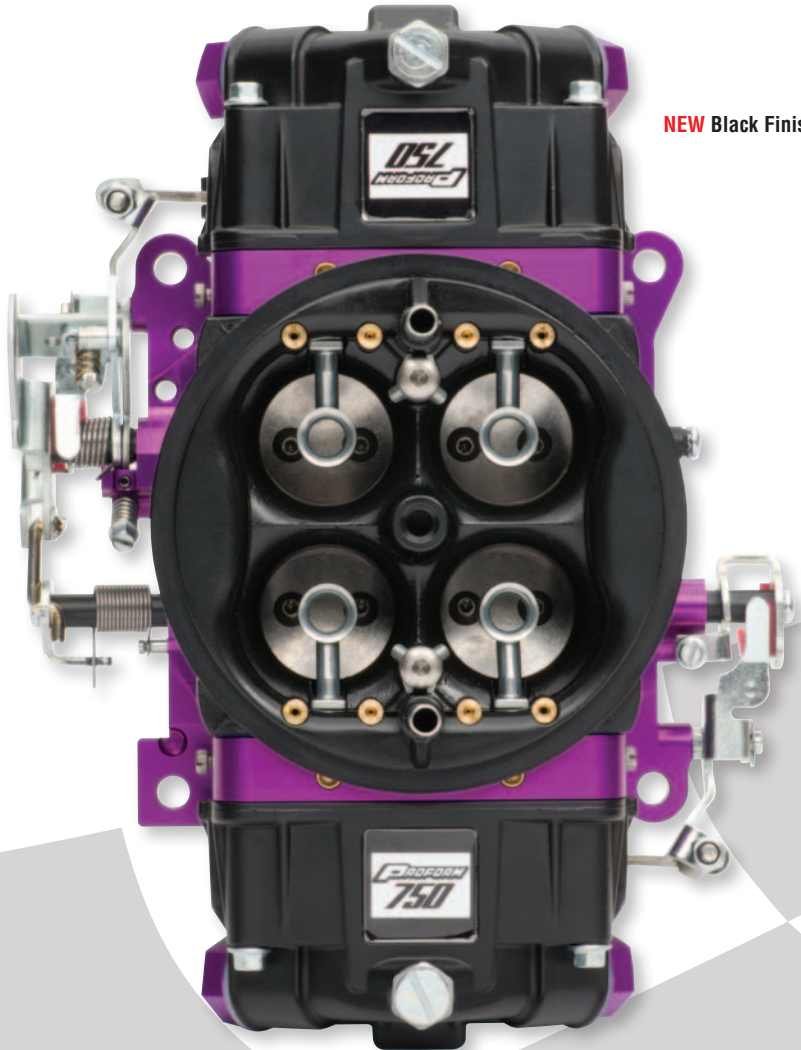

\*Product is legal only for off-highway use (except in CA or states that have adopted CA emission standards), racing use or for use on pre-emission-controlled motor vehicle/engines (pre-1966 domestic vehicles certified to CA standards, pre-1968 domestic vehicles certified to federal standards and all pre-1968 foreign vehicles), per manufacturer's application guide.

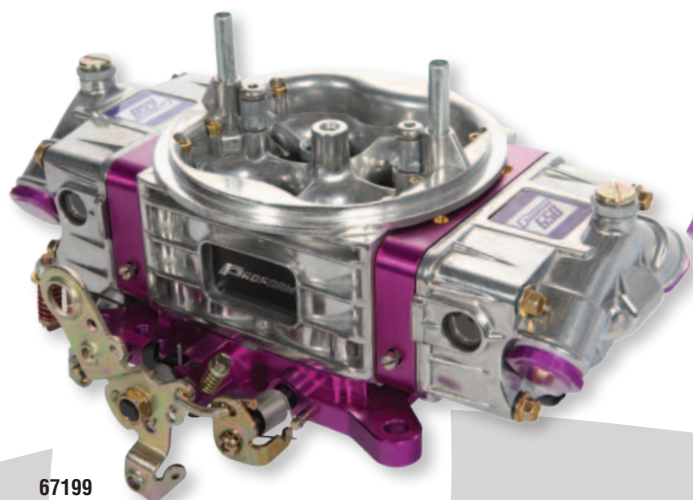

67199



**NEW Black Finish!**

67302



67209

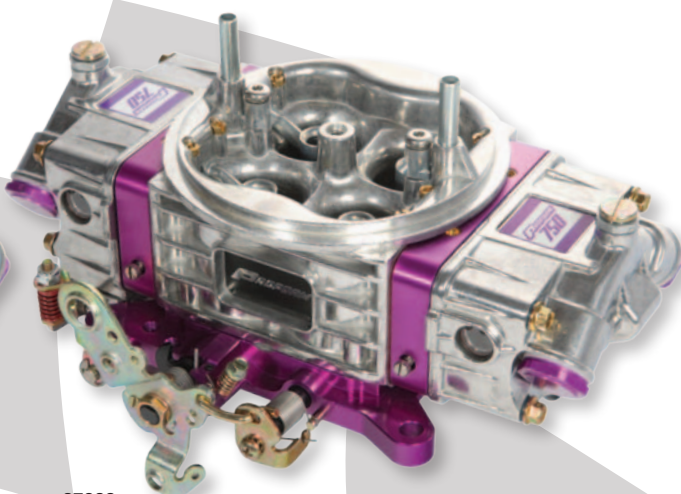

67200

### PROFORM® Circle Track Carburetors

The 750 CFM Circle Track Carburetor is joining the Race Series line of high-performance carburetors. This carburetor has all the great features of the Race Series plus special modifications to meet the circle track racers' needs.

**Features include:**

- Molded wedge floats to keep the fuel flowing in the turns
- A power valve in the secondary side of the for carb smooth transitions
- Teflon® bearing ribbons around the throttle shafts for smooth operation; and changeable operating links to control secondary opening rates.

67215.....750 CFM Circle Track carburetor with mechanical secondary

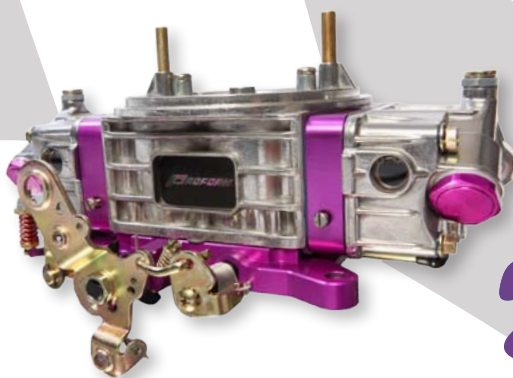



**PROFORM® Street Carburetors \***



**PROFORM's Street Series Carburetors are hand assembled in the U.S.**

**PROFORM® Street Series Carb**

Based on the wildly successful Race Series carburetors the new PROFORM street carburetors are constructed of light weight aluminum, and changeable idle air bleeds for easy non-permanent calibration changes if needed. Keep your drills in your tool box; fine tuning is accomplished by simply changing air bleeds not opening calibration restrictions with a drill bit.

**Each street carburetor features billet metering blocks with a street performance calibration** developed for today's high performance engines. Four corner idle on mechanical secondary carburetor to help fine tune the idle with aggressive camshaft profile. Changeable idle feed restrictions further expand the idle adjustment capabilities. Conventional service and tuning components are available in most performance retail outlets.

**You'll also find the popular billet throttle body for superior strength**, coupled with precision throttle shafts to ensure long term performance. All PROFORM® carburetors have easy access adjustable secondary air flow. Other carburetors require special tools or removal of the carburetor to accomplish this simple adjustment.

**The package is completed with high quality, light weight die-cast aluminum fuel bowls** with fuel level windows for quick visual reference. Float level changes do not require removal of a sight plug with the risk of fuel spilling all over the top of your engine. Bowls come equipped with 3/8" inverted flare fuel inlet fittings and will accept all conventional dual feed fuel lines compatible with Holley® four barrel carburetors. Like all PROFORM® carburetors, service parts are readily available however, should you not find PROFORM® service parts, our carburetors are compatible with any modular carburetor service parts available at your local parts store or favorite retail outlet.

**Mechanical Secondary Street Series Carburetors with electric choke**

- 67211 ..... 600 CFM Street Series Carburetor
- 67212 ..... 650 CFM Street Series Carburetor
- 67213 ..... 750 CFM Street Series Carburetor
- 67214 ..... 850 CFM Street Series Carburetor

**Vacuum Secondary Street Series Carburetors with electric choke**

- 67206 ..... 600 CFM Street Series Carburetor
- 67207 ..... 650 CFM Street Series Carburetor
- 67208 ..... 750 CFM Street Series Carburetor

**NEW BLACK STREET SERIES CARBURETORS!**

The Black Diamond® coating used on the main body and fuel bowls provides a durable finish which is impact resistant, and reduces fuel temperature by 6% based on thermal testing for enhanced performance. It is impervious to virtually all under hood chemicals and fuels, and is corrosion resistant. The black satin finish is easy to clean and gives your carburetor a great sleek look!

**Mechanical Secondary Black Street Series Carburetors with electric choke**

- NEW!** 67312 ..... 650 CFM Black Street Series Carburetor
- NEW!** 67313 ..... 750 CFM Black Street Series Carburetor
- NEW!** 67314 ..... 850 CFM Black Street Series Carburetor

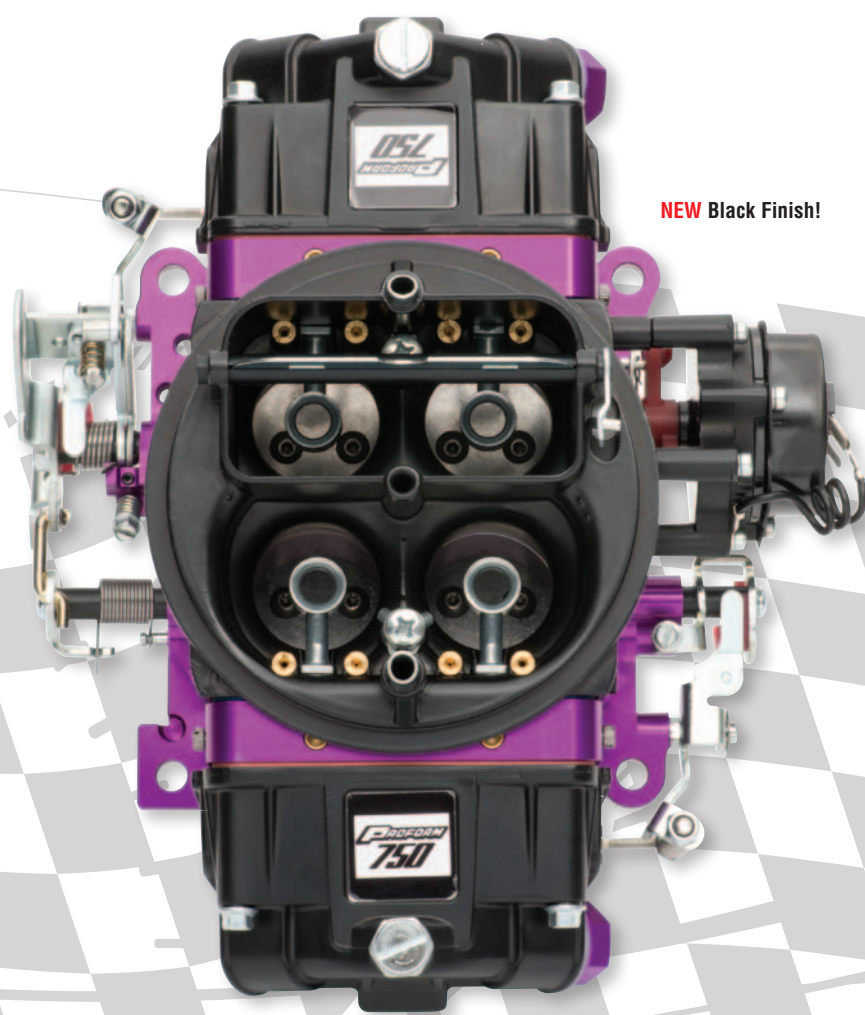

**NEW Black Finish!**

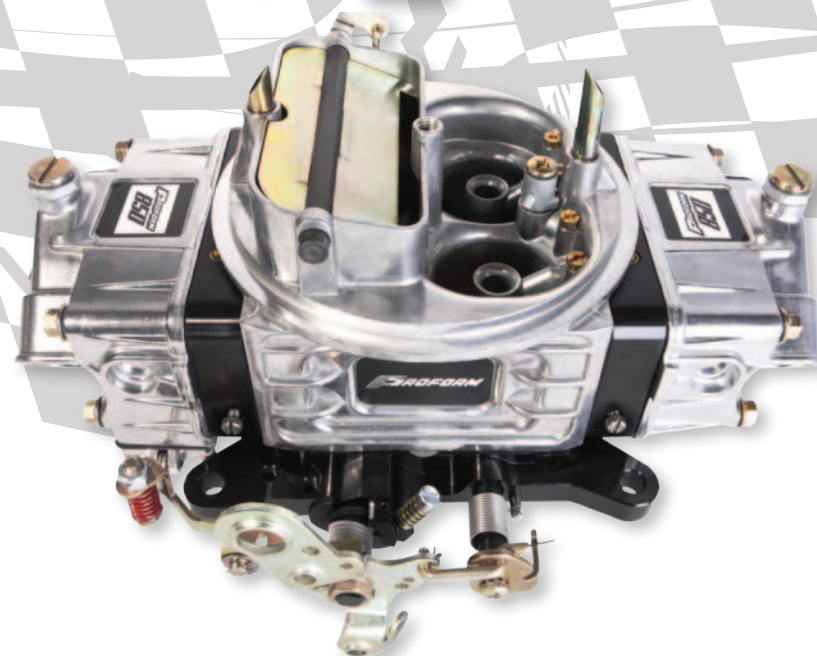

\*Product is legal only for off-highway use (except in CA or states that have adopted CA emission standards), racing use or for use on pre-emission-controlled motor vehicle/engines (pre-1966 domestic vehicles certified to CA standards, pre-1968 domestic vehicles certified to federal standards and all pre-1968 foreign vehicles), per manufacturer's application guide.

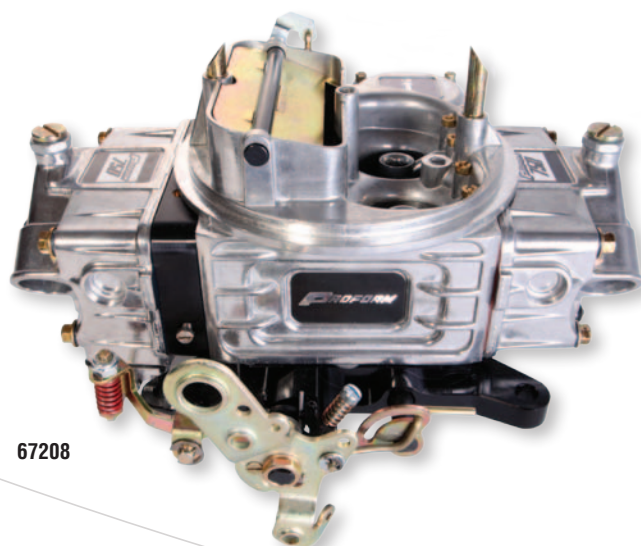

67208

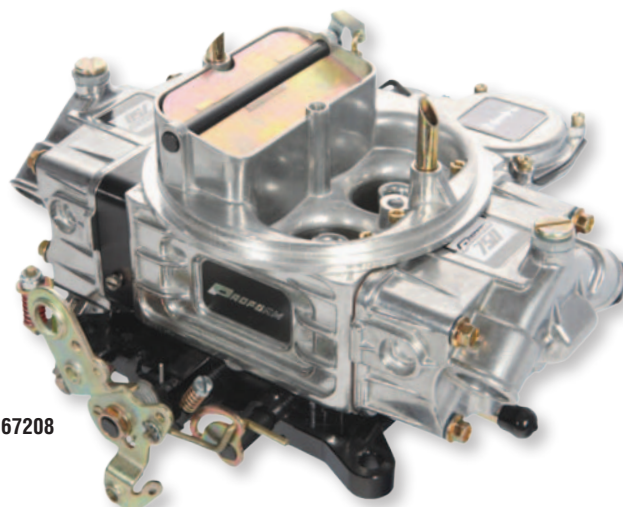

67208

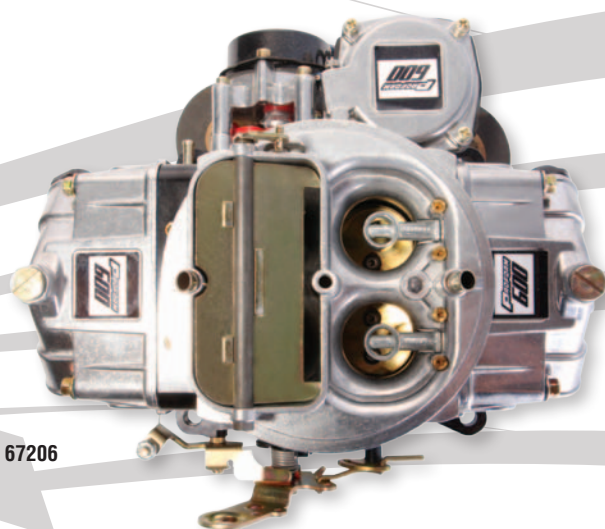

67206

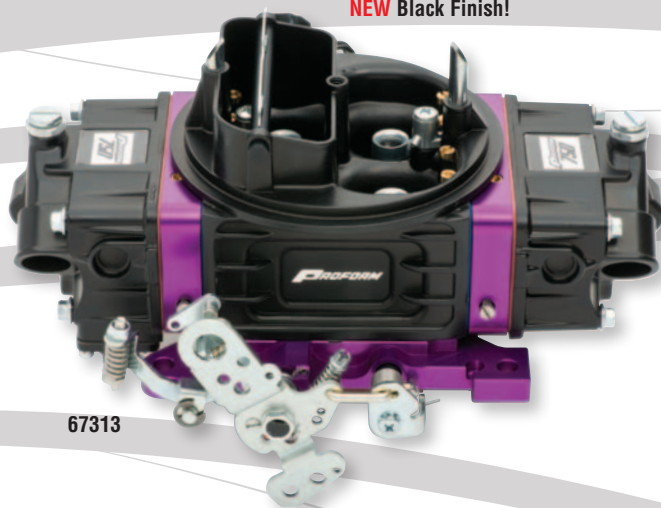

**NEW Black Finish!**

67313

**Thirteen Reasons to Buy Proform Street Carbs over the Competition at NO EXTRA COST!**

1. Electric Choke on all models!
2. Die-cast aluminum fuel bowls!
3. Fuel level sight glass windows!
4. Changeable idle air bleeds!
5. Billet Metering Blocks!
6. Changeable idle feed restrictors!
7. Billet base plates!
8. Serviceable throttle lever!
9. Easy Access Secondary idle air flow!
10. Enhanced look with bright anodizing!
11. Changeable high speed bleeds!
12. Notched secondary floats!
13. Secondary jet extensions!





## PROFORM® Carburetor Main Bodies\*

Direct Replacement Components to turn a street carburetor into a high-performance carb: get that extra performance out of your ride in less than 30 minutes! Add up to 25-50 HP with PROFORM's 100% NEW, high-performance carburetor main body (no re-built components). Easy swap-in, swap-out installation utilizing existing metering blocks, fuel bowls, and base plate. Involves only 14 screws. Has adjustable screw-in air bleeds, high-performance down-leg boosters. Get maximum air flow with no air horn, choke tower, or choke control. Comes in clamshell package with instructions, all necessary non-stick replacement gaskets and high-performance jet kit.

This product is supplied by Specialty Auto Parts U.S.A., Inc., and is not designed, made, endorsed, or sold by Holley Performance Products, Inc. or any other carburetor manufacturer.

**Technical Note:** Main body does not retain vacuum advance port in original metering block.

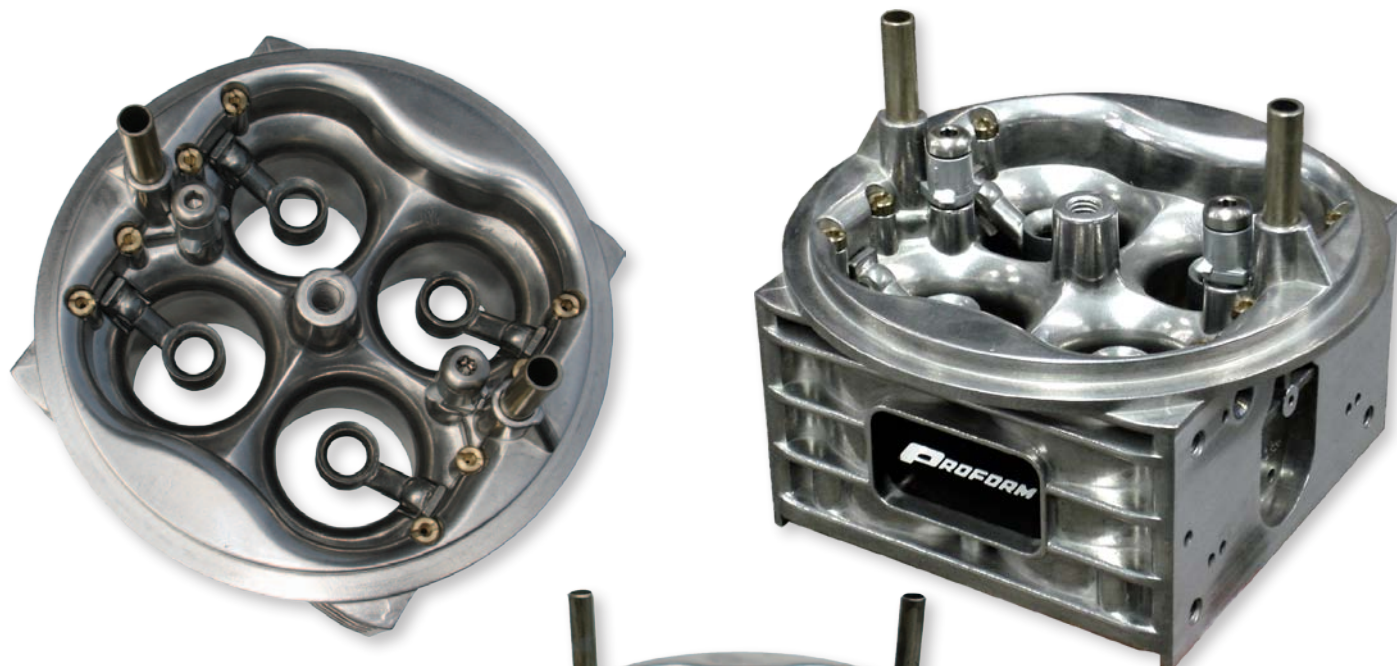

Component for use on Holley® 650 CFM (#4777), 700 CFM (#4778), 750 CFM (#4779) and 800 CFM (#4780) Double Pumper® with Mechanical Secondary applications.

- 67100C .....650 CFM, 700 CFM, 750 CFM, & 800 CFM
- 67203 .....650 CFM Replacement (flows up to 690 CFM)
- 67107C .....850 CFM Replacement (req.1 3/4 throttle body)
- 67108C .....950 CFM Replacement (req.1 3/4 throttle body)
- 67109C .....1050 CFM Replacement (req.1 3/4 throttle body)

850 CFM (requires 1 3/4 throttle body) Component for use on Holley® 750 CFM (#3310) Vacuum Secondary Carburetors.

67101C .....750 CFM Vacuum Secondary Carb

\*AVAILABILITY NOTICE: 67203 is currently only offered in zinc instead of standard aluminum.

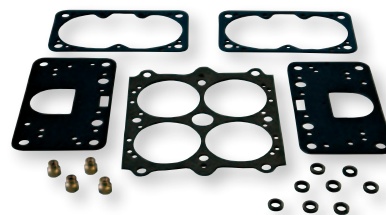

## PROFORM® Aluminum High-Performance Carburetor Main Bodies\*

These direct replacement components will save weight and turn your tired street carburetor into a high-performance racing carb.

- A. 67216.....750 CFM Replacement, Alcohol
- 67217.....750 CFM Replacement,
- Annular Boosters (not shown)
- B. 67218..... 1050 CFM Replacement,
- Annular Boosters

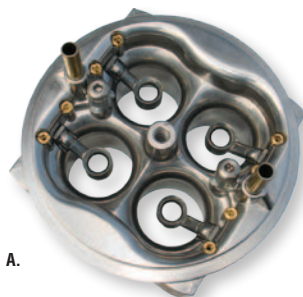

A.

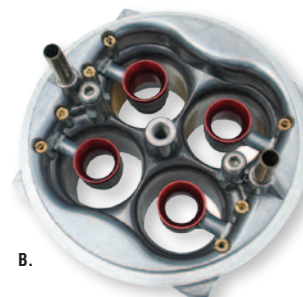

B.

PROFORM is a registered trademark of Specialty Auto Parts U.S.A., Inc. Holley® and Double Pumper® are registered trademarks of Holley Performance Products, Inc. No carburetor products sold under the PROFORM® trademark, including such parts as may fit with or replace a Holley® part number application, are designed, made, or endorsed by Holley Performance Products, Inc. or any other carburetor manufacturer.

### Billet Throttle Baseplates\*

Upgrade your carb with PROFORM's new Billet Throttle Base Plate! Made from solid billet construction versus die cast aluminum for added strength and durability this base plate comes with button torx head throttle plate screws, adjustable secondary air flow cam bracket, timed and full vacuum tubes for accessories and tuning, slip link mechanical secondary linkage, and power valve blow out protection!

Component for use on Holley® 750 CFM vacuum secondary carburetors.

**67148** ..... 750 CFM vacuum secondary

Component for use on Holley® 650 CFM through 800 CFM Double Pumper® with Mechanical Secondary applications, and PROFORM® Carburetor Main Body, part number 67100C.

**67155** ..... 650 CFM, 700 CFM, 750 CFM & 800 CFM

Component for use on Holley® 850, 950, and 1050 CFM Holley® Double Pumper® with Mechanical Secondary applications.

**67156** ..... 850 CFM, 950 CFM, and 1050 CFM

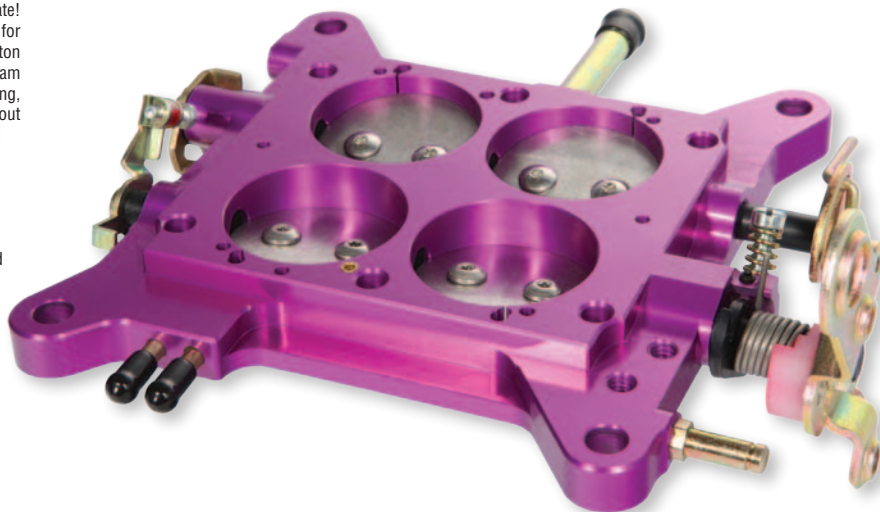

### Aluminum Fuel Bowl with Sight Glass Windows\*

Lightweight aluminum center-hung fuel bowls with sight glass windows for easy visual float adjustment. Kit comes with two (2) fuel bowls and two (2) gaskets and anodized aluminum 5/8" x 18 inverted flare fuel inlets. Fits PROFORM, Quick Fuel, and Holley Double Pumper carburetors.

**67162** ..... Aluminum Fuel Bowl Kit with Sight Glass Windows

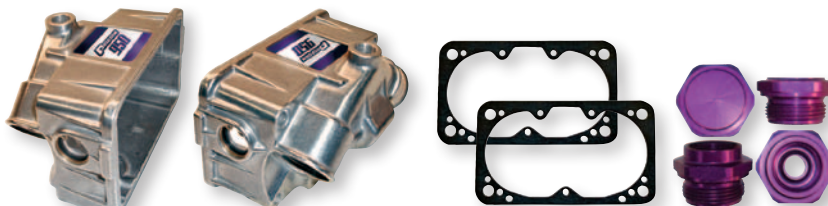

Includes Gaskets and Fuel Inlets!

### PROFORM® Upgrade Carburetors\*

**PROFORM's 100% Aluminum Upgrade Series Carburetors are hand assembled in the U.S.**

**The PROFORM® Upgrade Carb Includes:**

PROFORM upgrade carburetors are constructed of lightweight aluminum including changeable idle air bleeds for easy non-permanent calibration changes if needed. Fine tuning is accomplished by simply changing air bleeds not opening calibration restrictions with a drill bit.

**Each upgrade carburetor features metering blocks with a street performance calibration that's ready to roll right out of the box,** and developed for today's high performance engines. Four corner idle on mechanical secondary carburetor to help fine tune the idle with aggressive camshaft profile. Changeable idle feed restrictions further expand the idle adjustment capabilities. Conventional service and tuning components are available in most performance retail outlets.

**The package is completed with high quality, lightweight die-cast aluminum fuel bowls with fuel level windows for quick visual reference.** Float level changes do not require removal of a sight plug with the risk of fuel spilling all over the top of your engine. Bowls come equipped with 3/8" inverted flare fuel inlet fittings and will accept all conventional dual feed fuel lines compatible with Holley® four barrel carburetors.

Like all PROFORM® carburetors, service parts are readily available however, should you not find PROFORM® service parts, our carburetors are compatible with any modular carburetor service parts available at your local parts store or favorite retail outlet.

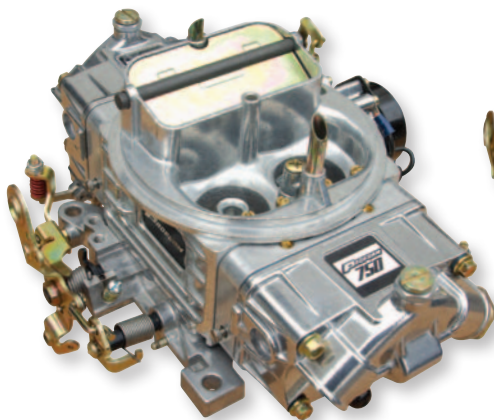

**Mechanical Secondary Upgrade Carburetors with electric choke**  
**67254**.....600 CFM Mechanical Secondary Street Carburetor  
**67255**.....650 CFM Mechanical Secondary Street Carburetor  
**67257**.....750 CFM Mechanical Secondary Street Carburetor  
**67259**.....850 CFM Mechanical Secondary Street Carburetor

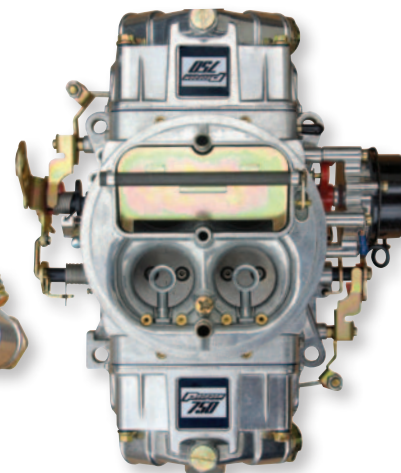

**Vacuum Secondary Upgrade Carburetors with electric choke**  
**67253**.....570 CFM Vacuum Secondary Street Carburetor  
**67256**.....670 CFM Vacuum Secondary Street Carburetor  
**67258**.....770 CFM Vacuum Secondary Street Carburetor



## CARBURETOR ACCESSORIES\*

### Billet Metering Blocks

#### Race-Oriented Calibration, Emulsion

Still using 1950's technology? Upgrade your carburetor with PROFORM's new race-oriented billet metering blocks. Each unit is CNC machined from solid billet aluminum for added strength and durability and features changeable idle feed restriction, 4 emulsions for more aggressive tuning, and additional racing application upgrades.



67150C ..... Race-Oriented Calibration Billet Metering Block, 1-pc per package

#### Standard Replacement Series

Primary metering block for all 2300, 4150, 4160 models except carburetors with an accelerator pump transfer tube or "reverse" idle mixture system. Uses standard fuel bowl and metering block gaskets. Timed spark or ported vacuum tube in original location. Improved throttle response over stock "universal" performance carburetor metering block. Black.

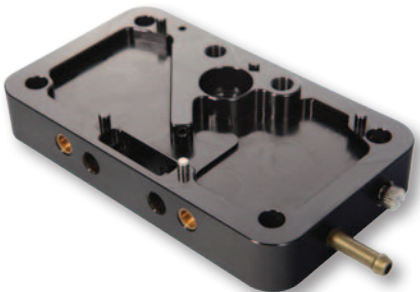

67166C ..... Standard Replacement Series Billet Metering Block, 1-pc per package

### Performance Rebuild Kits

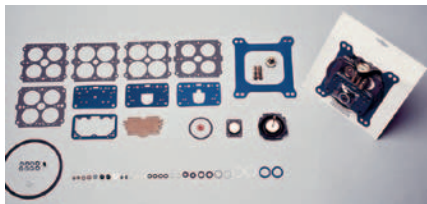

Performance rebuild kits include machined needle and seat assemblies, accelerator pump diaphragms, and non-stick precision die-cut gaskets with nylon inlet nut and bowl screw gaskets. Can be used with any racing gasoline.

- 67221 ..... Fits Holley® vacuum secondary 4 bbl, 450, 550, 600, 750, & 780 CFM (includes early versions of the list 3310 as well as universal carbs upgraded with secondary metering block)
- 67222 ..... Fits Holley® Double-Pumper carbs 600 - 850 CFM
- 67223 ..... Fits PROFORM 650 & 750 CFM as well as the Holley® HP Series of the same size
- 67224 ..... Fits PROFORM 850 & 950 CFM as well as the Holley® HP Series of the same size

#### Secondary Conversion Series for Single Inlet Carburetors

For single inlet vacuum secondary carburetors to replace the original metering plate with a billet metering block. Kit includes longer fuel bowl screw, longer transfer tube and all necessary gaskets, seals, etc.



67164C ..... Secondary Conversion Single Inlet Series Billet Metering Block, 1-pc per package

#### Secondary Conversion Series for Dual Inlet Carburetors

For dual inlet vacuum secondary carburetors to replace the original metering plate with a billet metering block. Kit includes all necessary gaskets for conversion. Available in Black.

**NOTE:** This conversion will require a longer dual feed line.

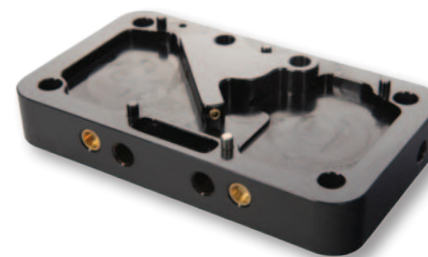

67163C ..... Secondary Conversion Dual Inlet Series Billet Metering Block, 1-pc per package

### Billet Metering Plate Conversion Kit

Now you can finally tune your rear jets! Upgrade your 4160 series 750 CFM carburetor (center hung float) with PROFORM's billet secondary metering plate conversion kit. Easily change your secondary jets for tunability and better horsepower gains. Each kit comes with a purple anodized billet metering plate, a metering plate/fuel bowl gasket and nylon fuel bowl screw gaskets.

67146 ..... Billet Secondary Metering Plate Conversion Kit



#### Double Pumper® Conversion Kit

Upgrade your Double Pumper® with race-ready billet metering blocks! Primary block retains the original vacuum provisions. Secondary block has no power valve provision to fit the latest generation of carburetors. Kit includes necessary gaskets for conversion. These blocks have a four corner idle system provision (you must have the correct throttle body for the four corner idle system to work). Available in Black.



67165C ..... Double Pumper® Billet Metering Block Conversion Kit, 2-pcs per package

### Billet Jet Plate

Lightweight jet storage plate holds up to 22 pairs of jets. Never lose or damage another jet again! A must-have for the carburetor tuner. Jet plate does not come with jets.

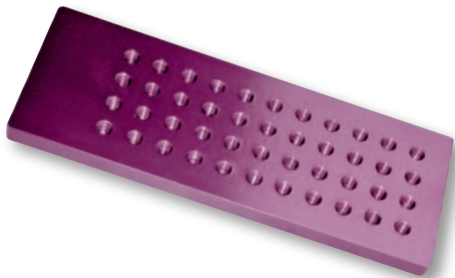

67115C ..... Billet Jet Plate

### Throttle Shaft Conversion Kits

Upgrade your PROFORM or Holley® carburetors (up to 1 3/4" throttle bores) to achieve higher air flow by reducing the size of the throttle shaft. Each kit includes button head (Torx) throttle plate screws, universal lever, and slip link secondary activation system. The High-Flow kit includes stainless steel button head screws.

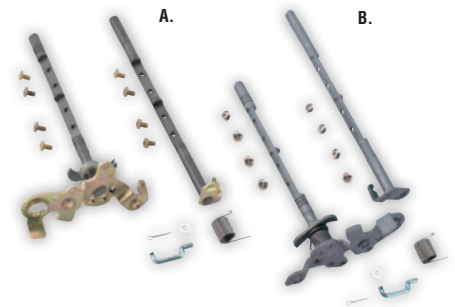

A. 67243..... Throttle Shaft Conversion Kit  
B. 67244..... High-Flow Throttle Shaft Conversion Kit

\*Product is legal only for off-highway use (except in CA or states that have adopted CA emission standards), racing use or for use on pre-emission-controlled motor vehicle/engines (pre-1966 domestic vehicles certified to CA standards, pre-1968 domestic vehicles certified to federal standards and all pre-1968 foreign vehicles), per manufacturer's application guide.

## Carburetor Tuning Accessories

### Non-Stick Gasket Kit

2 non-stick fuel bowl and 2 non-stick metering block gaskets.

67220 ..... Gasket Kit

### Gas Jet Kits

Precision manufactured to exacting flow for better tunability. Each kit comes with 2 jets. Comes with billet jet plate.

67226 ..... Jet Kit, No. 70 - No. 80

67227 ..... Jet Kit, No. 80 - No. 90

67228 ..... Jet Kit, No. 90 - No. 100

### Power Valves

Increase fuel flow and quicker response time resulting in precise calibration and predictability. Each power valve is hand tested in the U.S.A. to ensure quality.

67229 ..... Power Valve No. 2.5

67232 ..... Power Valve No. 3.5

67233 ..... Power Valve No. 4.5

67234 ..... Power Valve No. 6.5

### Needle and Seats Assemblies

Precision machined for exacting fuel flow with larger stem base on the needle for accurate response to float arm movement. For gasoline applications with Viton tip.

67238 ..... 0.110 adjustable

67239 ..... 0.120 adjustable

67240 ..... 0.130 adjustable

### AN Fuel Inlet Fittings Kit

Extended length fittings that can be easily tightened for an exact seal without damaging the fuel bowl. Each kit comes with 1 inlet fitting.

67241 ..... # 6 AN Inlet, 7/8"-20 fuel bowl

67242 ..... # 8 AN Inlet, 7/8"-20 fuel bowl

### Idle Feed Restriction Kits

For PROFORM carburetors and PROFORM metering blocks, each kit comes with 4 pieces.

67247 ..... 0.029"

67248 ..... 0.031"

67249 ..... 0.033"

67250 ..... 0.035"

67251 ..... 0.037"

67252 ..... 0.039"

### Adjustable Vacuum Secondary Housing Assembly

A complete bolt-on for any vacuum secondary carburetor. A simple one-screw adjustment varies initial point and opening rate.

67235 ..... Adjustable Vacuum Secondary Housing

### Replacement Secondary Diaphragm

Fits all PROFORM carburetors and all Holley® vacuum secondary carburetors except six pack, 3 bbl, and early Mopar applications.

67236 ..... Replacement Secondary Diaphragm

## Carb Float Adjustment Tool



No more sleight of hand tricks! Easily adjust your carburetor float level with this hand float adjustment tool. 5/8" socket and built-in screwdriver blade protects your engine and hands from fuel spray.

67443 ..... Carb Float Adjustment Tool

## Adjustable Secondary Cam Bracket

This newly designed secondary pump cam bracket features a mechanical idle enabling you to manually adjust the secondary throttle plates on your Holley® 4150 carbs and PROFORM carburetors.

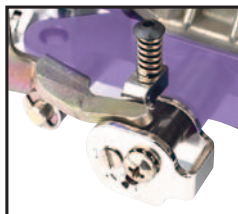

67237 ..... Adjustable Secondary Cam Bracket for Holley® 4150 and PROFORM carburetors

## Replacement Throttle Base Plates

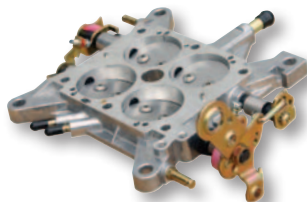

PROFORM's new cast aluminum base plates are an inexpensive way to replace your existing plate, though we'd strongly suggest you consider upgrading to our premium billet aluminum base plates, shown on p. 31. Features include button torx head throttle plate screws, timed and full vacuum tubes for accessories and tuning, slip link mechanical secondary linkage, and power valve blow out protection!

Component for use on Holley® 600 & 750 CFM vacuum secondary carburetors.

67267 ..... 600 CFM vacuum secondary

67269 ..... 750 CFM vacuum secondary

Component for use on Holley® 650 CFM through 800 CFM Double Pumper® with Mechanical Secondary applications, and PROFORM® Carburetor Main Body, part number 67100C.

67268 ..... 650 CFM, 700 CFM, 750 CFM, & 800 CFM mechanical secondary

Component for use on Holley® 600 CFM Holley® Double Pumper® with Mechanical Secondary applications.

67266 ..... 600 CFM mechanical secondary

## Aluminum Power Valve Remover Tool



Never damage your metering blocks again! PROFORM's new aluminum power valve remover tool makes power valve removal a snap. Simply place the tool over the power valve and give it an easy turn.

67454 ..... Aluminum Power Valve Remover Tool

## Trackside carb spacer kits

Easily optimize your flow rates with the new PROFORM modular 1" carb spacer kit! Each kit comes with one frame and 3 popular inserts: open, 4-hole, and tapered 4-hole. Various engine combinations have various fuel and air distribution requirements for maximum performance. Lightweight heat-resistant phenolic.



67160C ..... Carb spacer frame with open, 4-hole, and 4-hole tapered inserts



## Air Bleed Tuning Kit



PROFORM air bleed tuning kits include 4 each of 11 air bleeds. Each kit comes in a handy plastic storage container.

67245 ..... Air Bleed Tuning Kit, High Speed System No. 25 - 35

67246 ..... Air Bleed Tuning Kit, Idle Air Bleed System No. 65 - 75

## Jet Installation Tool



Don't damage your jets with a clumsy screwdriver. This handy tool makes installation and removal of jets a cinch.

67469 ..... Jet Installation Tool



Can you tell the difference between a quality mini starter, chrome alternator, HEI distributor, electric water pump, electric fan, and one that's made to lesser standards? No, most enthusiasts can't because most of these products look nearly the same – so that's why what's on the inside is critical. Choosing PROFORM is choosing electrical parts with components produced and tested by highly specialized machines, assembled by highly trained personnel using dedicated jigs and equipment, with everything 100% new\* for maximum longevity and optimum performance. In many cases each subcomponent is tested before it gets onto the production line. After assembly each product is individually tested at the factory. Finally, it's boxed in eye catching retail packaging that stands out from the competition. We do the testing, not you! And PROFORM proves it! If you'd like to know more about how these great PROFORM products are made, scan the QR codes on this page to see videos of the manufacturing and testing processes.



\*except for a limited number of distributor housings.





# The PROFORM difference...



Precision Manufacturing!

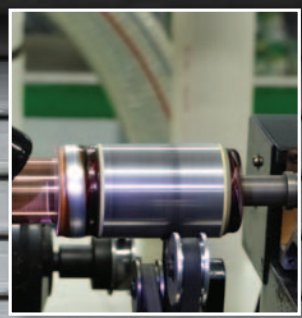

Balanced for Maximum Performance!

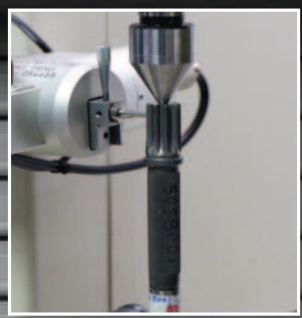

Exacting Standards!



Quality Raw Materials!

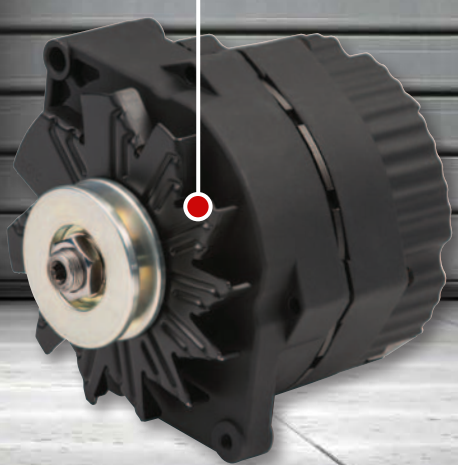

**Quality and Performance in Every Part!**

**Superior Components = Superior Performance**



Can you tell the difference between a quality alternator, and one that's made to lesser standards? Most alternators (especially chrome ones) look nearly the same – so it's what's on the inside that's critical. Choosing PROFORM is choosing alternators with components produced by highly specialized machines, assembled by highly trained personnel using dedicated jigs and equipment, with everything 100% new for maximum longevity and optimum performance. After assembly, each alternator is **individually tested at the factory**. Finally, it's boxed with a quality assurance graph that documents the specific unit's output performance. We do the testing, not you! And PROFORM proves it!



### 100% NEW, 10SI-Style, Alternators

Like all PROFORM alternators, these alternators are 100% new, include a machined V-belt pulley, and lastly are tested at the component level and the finished level to insure the best product possible. Weighs 11 lbs.

Available in Black Crinkle, Chrome, and Natural finishes.

For a new level of quality and reliability, insist on 100% NEW!

### NEW BLACK CRINKLE FINISH!

- NEW!** 66448.1N.....GM 100 AMP, 1-wire
- NEW!** 66448.12N.....GM 120 AMP, 1-wire

### Chrome Alternators

- 66445N .....GM '73-'86 Internal Regulator
- 66445.1N.....GM 100 AMP, 1-wire
- 66445.8N.....GM 80 AMP, 1-wire
- 66445.6N.....GM 60 AMP, 1-wire
- 66445.12N ....GM 120 AMP, 1-wire
- 66445.14N ....GM 140 AMP, 1-wire

### Natural Finish Alternators

- 66434.....GM 100 AMP, 1-wire
- 66436.....GM '73-'86 Internal Regulator

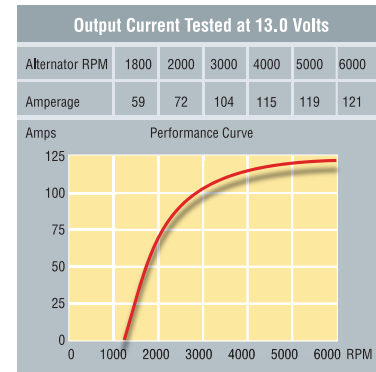

We certify these results are within specification.

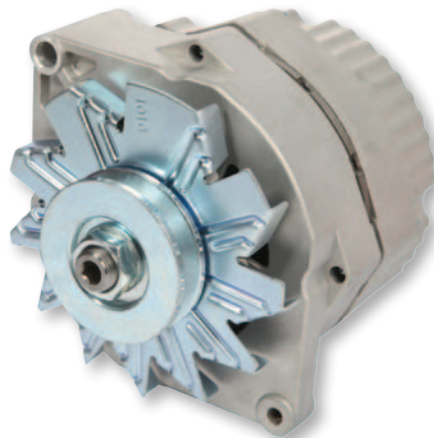

**NEW! 50 AMP, 1-WIRE, MINI ALTERNATORS!**

Not looking to power a small village with your alternator, and drop 5 pounds from the front end at the same time? These small but powerful alternators are perfect for the racer looking for something reliable, and the cruiser looking for something small that looks good.

Like all PROFORM alternators, these new mini alternators are 100% new, include a machined V-belt pulley, and lastly are tested at the component level and the finished level to insure the best product possible. Weighs 6 lbs. Available in Black Crinkle, and Polished finishes.

- NEW! 66432.....Black Crinkle 50 AMP, 1-wire**
- NEW! 66433.....Polished 50 AMP, 1-wire**

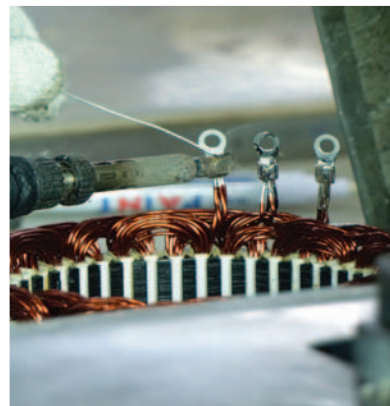

**100 AMP Alternators - 100% NEW**

100% New 100 AMP GM alternator. GM internal regulator. Available for about 1/2 the cost of competitive models, this reliable internal-fan unit is compact and powerful. Use existing mounting brackets and electrical hook-up.

**66439 ..... Chrome**



**Alternators Brackets**

Chevrolet small-block thru '68.

- A. 66114.....Short Water Pump & Headers**
- B. 66661.....Side-mount with Headers**
- C. 66115.....Universal Alt/Generator Arm**
- D. 66179 ..... Universal Cut-To-Size Spacer**





Can you tell the difference between a quality starter, and one that's made to lesser standards? Most mini-starters look nearly the same – so it's what's on the inside that's critical. Choosing PROFORM is choosing starters with components produced by highly specialized machines, assembled by highly trained personnel using dedicated jigs and equipment, with everything 100% new for maximum longevity and optimum performance. After assembly each starter is **individually tested at the factory**.

Finally, it's packaged with a quality assurance graph that documents the specific unit's output performance. We do the testing, not you! And PROFORM proves it!



## Starters

### GM

High-torque, gear-reduction design. 100% NEW, not rebuilt. Offset design results in more clearance between the oil pan and the starter, and can be rotated for additional chassis clearance. The high-torque, high-output motor spins the engine over faster than stock starters, delivering 40-50% more cranking power. 3.75-to-1 sealed gear-reduction drive and full ball bearing construction. Includes shims to set pinion-gear engagement (when necessary). Approved by all leading sanctioning organizations.

Straight mounting bolt alignment starters fit all Chevy V6, and Small & Big Block V8 engines using 153 or 168 tooth flywheels. New staggered mounting plate fits 168 tooth flywheels only. Heavy-duty PROFORM weighs 1-1/2 lbs. more and is 1" longer than

- 66256 .....12V 1.4 KW motor
- NEW!** 66266 .....12V 1.4 KW motor, Staggered Mount
- 66258 .....Heavy Duty 12V 2.0 KW motor
- NEW!** 66267 .....12V 2.0 KW motor, Staggered Mount (not shown)

66259 .....Chrome, 12V 1.4 KW motor



11:1



Fits LS1, 2, 6, & 7.  
66273.....12V 1.4 KW motor.



11:1



15:1



11:1

- 66256P ..... Replacement Pinion for 66256, 66258, and other Hitachi-style starters
- 66256SS ..... Spring & Clip Kit for 66256P
- 66256S ..... Replacement Solenoid for 66256, 66270, 66271, and other Hitachi-style starters, except 66258
- 66258S ..... Replacement Solenoid for 66258



All  = Maximum Recommended Compression Ratio



15:1



11:1

Fits Pontiac and Olds.  
66257.....12V 1.4 KW motor  
**NEW!** 66265.....12V 2.0 KW motor

Fits Buick 455.  
66260.....12V 1.4 KW motor  
**NEW!** 66262.....12V 2.0 KW motor (not shown)

Fits all Chevy V6 and small and big block V8 engines with staggered bold pattern and 168 tooth flywheels.

66268 ..... Staggered Bolt Pattern.

Stock Replacement. For High Performance, see p/n 67052

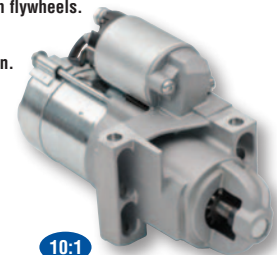

10:1

## High-Compression Racing Starters GM

For engines with monster cubic inches or compression-ratios, these 100% NEW starters challenge the specifications, durability, and reliability of anything on the market. Built from scratch with all-new components, the torque rating is a healthy 4.41:1 gear reduction, capable of cranking engines up to a whopping 14:1 compression. Comes in the NEW Race Box Packaging! Fits Chevy small and big block engines. Fits Chevy V8.

67051 ..... 153-tooth flywheel

67050 ..... 168-tooth flywheel

67052 ..... Staggered mount, with 168-tooth flywheel

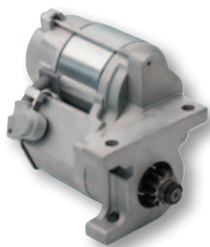

14:1



14:1

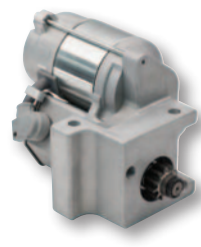

14:1

## Ford



11:1

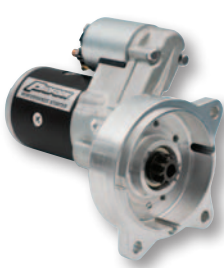

11:1



15:1

Fits Ford small and big block V8, and 221- 351W & 460 engines.

66270 ..... Ford, 1.4 KW motor, auto trans.

66271 ..... Ford, 1.4 KW motor, std. trans.

**NEW!** 66275 ..... Ford, 2.0 KW motor, auto trans.

**NEW!** 66276 ..... Ford, 2.0 KW motor, std. trans. (not shown)

## Chrysler



14:1

Fits Chrysler small and big block V8. Lightweight.  
66269 ..... Chrysler V8, 4.41:1 Gear Reduction Starter

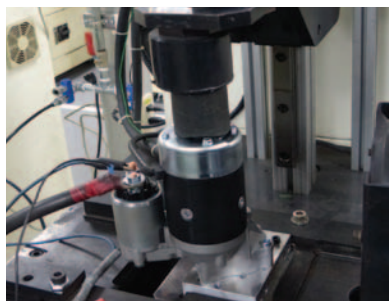

Endurance testing, part no. 66258



**NEW PACKAGING!**



**Chevy Big-Block**



**Included Chevy Small-Block Accessories.**



*Weather-Tight Connector!*

**Precision Windings for Optimum Performance**



**Ford Small-Block**



*Billet Backing Plate Included with Ford Models*

**Fits Chevy Small-Block**

Ever consider going electric? PROFORM's affordable electric water pumps eliminate unnecessary weight and impeller-drag experienced at high RPM, pump up to 35+ gallons of water per minute, and deliver the cooling that can make the difference between a win and second place! Durable but light-weight die-cast aluminum, epoxy powder coated for corrosion resistance in the color of your choice. Race or street. Comes with mating weather-tight connector. Draws 6 amps. Billet fitting (1" pipe to 13/4" hose) included.

- 66225B ..... Electric water pump, blue
- 66225BK ..... Electric water pump, black
- 66225R ..... Electric water pump, red
- 66225C ..... Electric water pump, chrome
- 66225P ..... Electric water pump, polished

**Fits Chevy Big Block**

- 68230B ..... Chevy B/B, electric water pump, blue
- 68230BK ..... Chevy B/B, electric water pump, black
- 68230R ..... Chevy B/B, electric water pump, red
- 68230C ..... Chevy B/B, electric water pump, chrome
- 68230P ..... Chevy B/B, electric water pump, polished

**Fits Chrysler Big-Block**

This all new PROFORM billet electric big block Chrysler water pump features the durable PROFORM 12-volt motor, billet mounting plate for added strength, and pumps up to 35+ gallons of water per minute. Fits B, RB and Hemi engines.



- 66219.....Billet Electric BB Chrysler Water Pump
- 66227.....Aluminum Pulley-drive B/B Chrysler Water Pump
- 66228.....Aluminum Water Pump Housing for part no. 66219

**Fits Chrysler Small-Block**

- 66237..... Billet Backing Plate, natural

**Fits Ford Small-Block**

Based on the popular Chevy versions the new Ford small-block electric water pump features a durable 12-volt motor pumping up to 35+ gallons of water per minute. Each pump is made from durable but light-weight die-cast aluminum with epoxy powder coating for corrosion resistance. Comes with FREE billet aluminum backing plate, mating weather-tight connector and inlet fitting. Draws 6 amps. Available in 5 colors.

- 68220B.... Ford S/B, electric water pump, blue
- 68220BK.. Ford S/B, electric water pump, black
- 68220R... Ford S/B, electric water pump, red
- 68220C... Ford S/B, electric water pump, chrome
- 68220P.... Ford S/B, electric water pump, polished
- 66239..... Billet Backing Plate, natural



66227



66228

*Saves 5 lbs.!*

## High Flow Aluminum Water Pumps

PROFORM's new high flow mechanical water pumps feature heavy duty ball bearings for up to 40% more coolant flow giving you real performance value for your dollar. Available in the stock cast look (satin) or the wildly popular polished.

### Fits Chevy small-block

- A. 67264.....Long, Polished
- B. 67265.....Long, Satin Finish
- C. 68244.....Short, Polished
- D. 68245.....Short, Satin Finish

### Fits Chevy big-block

- E. 68240.....**NEW!** Long, Polished
- F. 68241.....**NEW!** Long, Satin Finish
- G. 68242.....**NEW!** Short, Polished
- H. 68243.....**NEW!** Short, Satin Finish



A.

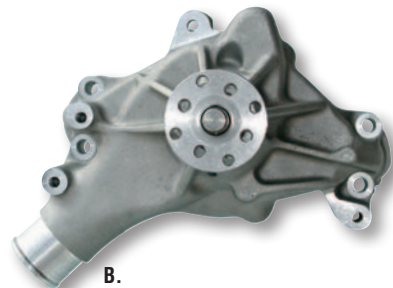

B.



C.



D.

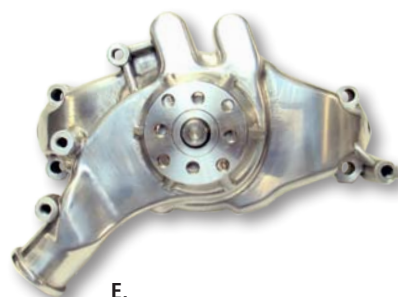

E.

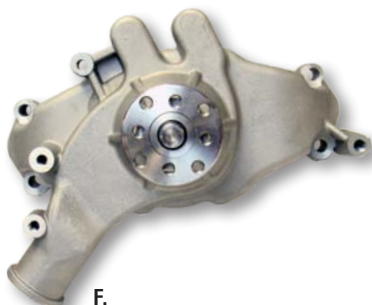

F.

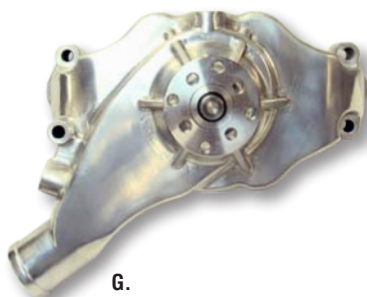

G.

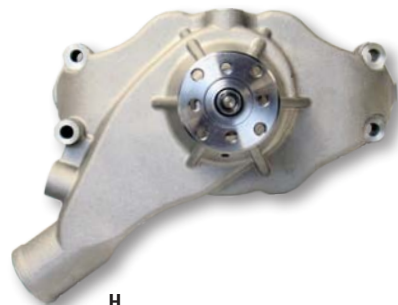

H.

## Billet Aluminum Radiator Overflow Canisters

Stuck in traffic, temperature gauge starting to rise? When your radiator fluid gets too hot, it will blow through your overflow spout and all over your engine bay unless you have an overflow canister for this exact situation. PROFORM's new overflow canisters are anodized billet aluminum with brass fittings to give your engine bay a nice clean look. Canister measures 6.75" tall, and 3" diameter.

- 69527.....Black anodized overflow canister
- 69528.....Natural anodized overflow canister



## Black Billet Aluminum Bowtie Radiator Cap

Why not make the first thing you see when you open your hood a Bowtie radiator cap? This sleek radiator cap is comprised of three parts: a Stant® 13 psi radiator cap, a black anodized aluminum cap cover with knurled perimeter, and lastly an embossed metal Bowtie emblem that can be centered nicely after the radiator cap has been installed. This ensures the Bowtie is lined up the way you'd like it to be!

- 141-820.....Black Billet Aluminum Bowtie Radiator Cap





## DISTRIBUTORS\*



### Chevy HEI Electronic Racing Distributors With Coil, 100% New!

Designed to meet the high performance demands of racing competition, these units fit Chevy small block and big block engines. These 100% NEW distributors have all the reliable components of the 66940, but they also include a high-power 50,000 volt coil.

This high-performance distributor produces a 50,000 volt spark through 7,500 RPM with true spark alignment for instantaneous response, a high performance curve, a premium cap with brass terminals, and a low-saturation ignition module. All have die-cast aluminum housings, polished to a brilliant billet-look appearance, except as noted.

#### NEW 66941R Package!

- 66941R .....Red Cap
- 66941RC.....Red Cap
- 66941B .....Blue Cap
- 66941BC.....Blue Cap
- 66941BK.....Black Cap
- 66941BKC.....Black Cap
- 66941BKU.....Black Cap, Unpolished
- 66941BKUC...Black Cap, Unpolished
- 66941TU.....Tan Cap, Unpolished
- 66941TUC.....Tan Cap, Unpolished



- Same as above, but without vacuum advance: uses nylon lock-out.
- 66941RM.....w/o Mech. Adv., Red Cap
  - 66941BM.....w/o Mech. Adv., Blue Cap
  - 66941BKM....w/o Mech. Adv., Black Cap
  - 67022C.....Distributor Vacuum Advance Lockout, GM HEI

### Chevy V8 HEI Hi-Performance Distributors

Fits '55 - 82 Chevy small block and big block engines. NO rebuilt components: 100% NEW! It has a high-performance control module, a hardened gear, a capacitor that prevents radio static, a high-dielectric cap with brass terminals, and a premium rotor.

- 66940 ..... Tan cap
- 66940C ..... Tan cap
- 66940R ..... Red cap
- 66940RC..... Red cap
- 66940B ..... Blue cap



### Pontiac HEI Electronic Distributor

Fits Pontiac small block and big block engines. Supplied with 50,000 volt coil and rotor.

- 66953.....Red Cap

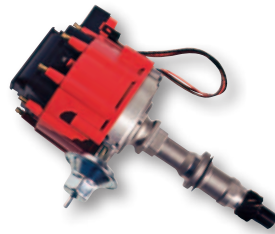

### Olds HEI Electric Distributor

Fits Oldsmobile V8 engines. Supplied with 50,000 volt coil and rotor.

- 66955.....Red Cap



### GM HEI Street/Strip Distributors

These units offer calibrated advance curves that are optimized for maximum combustion efficiency and for the elimination of detonation damage and throttle ping. Assembled from precision-made parts for advance curve smoothness. Offers longer term durability and a higher voltage spark that permits a bigger spark plug gap, resulting in more power and reduced plug fouling. Each unit includes a high-power coil, a premium hi-dielectric red cap with brass terminals, and a low-saturation ignition module.

- 67080 .....Chevy V6, 262 cid
- 67081 .....Chevy Inline 6 Cylinder
- 67082 .....*It's Back!* Chevy V6, 173 cid, 2.8 ltr 6
- 67084 .....Chevy V6, 200-229 cid

- 67088 .....Buick V8, 215-350 cid
- 67090 .....Buick V6, Even Fire
- 67091 .....Buick V6, Odd Fire
- 67093 .....Pontiac/Chevy 4 Cyl., 151 cid

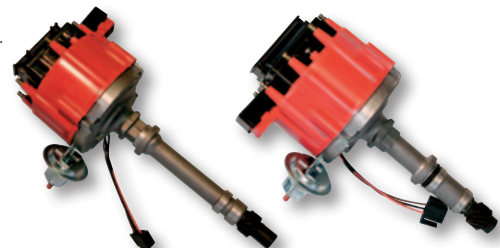

\*Product is legal only for off-highway use (except in CA or states that have adopted CA emission standards), racing use or for use on pre-emission-controlled motor vehicle/engines (pre-1966 domestic vehicles certified to CA standards, pre-1968 domestic vehicles certified to federal standards and all pre-1968 foreign vehicles), per manufacturer's application guide.

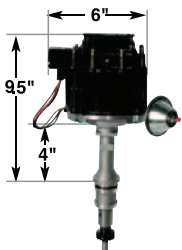

### Ford HEI Street/Strip Distributors, 100% NEW!

Fits Ford 289 - 302 (5.0). Utilizing the durable and dependable High Energy Ignition (HEI) system pioneered by GM, these distributors avoid the unsightly wiring of stock Ford electronic ignition systems by installing this one-piece distributor with an internally positioned coil and module. Easy to install: just connect one 12-volt hot wire to the distributor (has optional tach hook-up). These units offer calibrated advance curves that are optimized for maximum combustion efficiency and for the elimination of detonation damage and throttle ping. Assembled from precision-made parts for advance curve smoothness. Offers longer term durability and a higher voltage spark that permits a bigger spark plug gap, resulting in more power and reduced plug fouling. Each unit includes a high-power coil, a premium hi-dielectric cap with brass terminals, and a low-saturation ignition module. By eliminating the stock-Ford ballast resistor, more ignition voltage results in improved spark. Incorporates easily found High Energy Ignition (HEI) replacement parts. Assembled with upper and lower bushings (stock Ford distributors have only a single bushing).

- 66969R ..... Ford 221-289-302, Red Cap
- 66969B ..... Ford 221-289-302, Blue Cap
- 66969BK ..... Ford 221-289-302, Black Cap
- 66980R ..... Ford 351C-400M-439-460, Red Cap
- 66980B ..... Ford 351C-400M-439-460, Blue Cap
- 66980BK ..... Ford 351C-400M-439-460, Black Cap
- 66983R ..... Ford 351 Windsor, Red Cap
- 66983B ..... Ford 351 Windsor, Blue Cap
- 66983BK ..... Ford 351 Windsor, Black Cap

*Technical Note:* Gear not compatible with billet roller cams. If using a billet roller cam, please contact the cam manufacturer for proper gear selection.

### Chrysler Electric HEI Street/Strip Distributor

This 100% NEW high-performance distributor produces a 50,000 volt spark through 7,500 RPM. Easy 1-wire hookup, low-saturation ignition module, premium cap with brass terminals, and high-power coil!

- 67040 ..... 273-318-340-360



### AMC HEI Electric Distributors

Utilizing the durable and dependable High Energy Ignition (HEI) system pioneered by GM, these units offer calibrated advance curves that are optimized for maximum combustion efficiency and for the elimination of detonation damage. Durable one-piece design: the coil and module are mounted internally for easy one-wire hook-up. Each unit includes a high-power coil, a premium hi-dielectric red cap with brass terminals, and a low-saturation ignition module. By eliminating the stock- AMC ballast resistor, more ignition voltage results in improved spark that permits a bigger spark plug gap, resulting in more power and reduced plug fouling. Incorporates easily found High Energy Ignition (HEI) replacement parts.

- 67185 ..... AMC 290-304-343-360-390-401
- 67186 ..... AMC 232-258 Inline 6 Cylinder

### Chrysler Electric Conversion Distributors Kits

These complete high performance distributor kits will convert your old point-type ignition to new electronic ignition. Each kit includes distributor with high performance advance curve, along with an electronic control unit, wiring harness, ballast resistor, and detailed installation instructions.

- 66991 ..... 273-318-340-360
- 66993 ..... 361-383-400
- 66995 ..... 413-426W-440-426 Hemi

New Chrysler Bushing Installer Tool, see page 76



### Chrysler Electric Distributors

Vacuum advance models. Each high performance, blueprinted distributor is factory set with a high-performance advance curve. Includes an adjustable vacuum advance unit, a premium black cap with brass inserts for maximum conductivity, and rotor.

- 66990 ..... 273-318-340-360
- 66992 ..... 361-383-400
- 66994 ..... 413-426W-440-426 Hemi

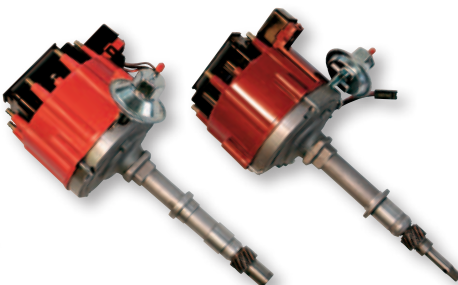
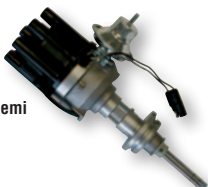



## DISTRIBUTOR ACCESSORIES \*

### GM HEI Distributor Tune-Up Kits

GM V8 HEI electronic tune-up kit: Contains high-power 50,000 volt HEI coil; superior "no arc" rotor; coil dust cover; high-performance, low-saturation control module; adjustable vacuum advance unit; HEI bushing; wire harness & capacitor; high-performance advance spring & weight set; and mounting hardware.

- 66945BC.....Blue Cap
- 66945BKC.....Black Cap
- 66945RC.....Red Cap
- Same as above but for GM V6.
- 66949RC.....GM V6 HEI Dist Tune-Up Kit, Red cap



### High-Performance External Coil

Fits late model GM. Replaces stock coils with 35,000 Volts.

- 66937C .....45,000 Volts



### Cap & Rotor Kit

Fits GM V8.

- 66947BC..... Blue Cap
- 66947BKC.....Black Cap
- 66947RC.....Red Cap

Fits GM V6.

**NEW!** 66916RC.....Red Cap (Not Shown)



### High-Power 50,000 Volt HEI Coil Cap Kits

F50,000 Volt coil and premium hi-dielectric caps with brass terminals, and premium rotor. Supplied in clamshell packaging.

- 66942BC..... Blue Cap
- 66942BKC.....Black Cap
- 66942RC.....Red Cap

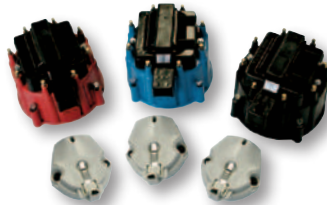

### GM High-Performance 50,000 Volt HEI Coil

Results in more completely burned fuel. Offers 15,000 more volts than stock.

- 66943C .....50,000 V Coil

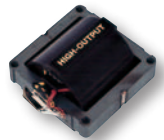

### Wire Harness and Capacitor

Wire Harness and Capacitor. When upgrading your distributor, don't overlook this essential component.

- 66946C .....Harness Kit



### High-Performance Ignition Module

Engineered with low saturation for maximum spark intensity.

- 66944C .....Ignition Module

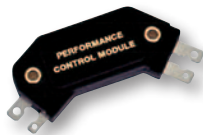

### HEI Adjustable Vacuum Advance

Fits GM. For fine-tuning your vacuum advance for optimum performance.

- 66952C ..... Vacuum Advance



\*Product is legal only for off-highway use (except in CA or states that have adopted CA emission standards), racing use or for use on pre-emission-controlled motor vehicle/engines (pre-1966 domestic vehicles certified to CA standards, pre-1968 domestic vehicles certified to federal standards and all pre-1968 foreign vehicles), per manufacturer's application guide.

### GM V8 HEI Dust Cover

For use when roller tip is not required. Proven OEM quality. Extra long slot eliminates rocker to stud interference when using high lift cams. 16 rockers, grooved balls and nuts per package.  
**Fits Chevy small block engines.**

66957C ..... Dust Cover



### HEI Advance Curve Kit

HEI Advance Curve Kit. Offered with three sets of springs for custom curving your own distributor.

66948C ..... Advance Kit



### Universal High-Performance Chrome Coil

Rated at 45,000 volts. Universal. Cylinder style.

66958C ..... Universal Coil



### Ford High-Performance Coil

High-performance Ford Mustang coil, rated at 45,000 volts.

66959C ..... Ford Coil



### Chevy Iron Distributor Gear

Fits Chevy small block and big block engines with 0.491" shaft. Replacement component.

66961C ..... Distributor Gear



### Billet Hold Down Clamps

Heavy-Duty Machined Aluminum. Fits Chevrolet. S/B, V6/90°, B/B. Includes Clamp, Stainless Steel Stud, Nut and Washer.

66985 ..... Billet Look  
 66986 ..... Blue  
 66987 ..... Red



## Pushrods

### 1-Piece Pushrod Sets

Heat-treated .065 wall thickness 4130 chrome moly, for use with guide plates. 25% thicker walls than a major competitor's brand. Gloss black finish. Premium one-piece pushrods for the price of competitors' 3-piece! Each end is precision formed with specified radius for optimum wear characteristics with minimal metal-to-metal friction. 16 pieces per package.

**Fits Chevrolet small block engines.**

- 66891C ..... 5/16" stock length
- 66892C ..... 5/16" +.100
- 66402C ..... 5/16" +.160"
- 66403C ..... 5/16" +.200"
- 66404C ..... 5/16" OEM roller
- 66405C ..... 5/16" Crane® roller
- 66406C ..... 3/8" stock length

**Fits Chevrolet big block engines.**

- 66407C ..... 3/8" stock length
- 66408C ..... 7/16" stock length

NOTE: 3-pc unit

66409C ..... 3/8" +.405" tall deck

**Fits Ford engines.**

- 66410C ..... 5/16" 289-302
  - 66413C ..... 5/16" 351C 1969-94
  - 66414C ..... 5/16" 429 Super CJ70
  - 66423C ..... 5/16" 289-302 with OEM rollers
- Fits Pontiac V8.**
- 66415C ..... 287-455, 1957-81
- Fits Oldsmobile V8 with hydraulic lifters.**
- 66427C ..... 3/8", 260-403, 1964-84



## 2 - Piece Pushrod Sets

### 1-Piece Pushrod Sets

Heat-treated .065 wall thickness 4130 chrome moly, for use with guide plates. These pushrods are manufactured with one end having a heat-treated insert, and the other end precision-formed to meet friction-reducing specified radius. 16 pieces.

**Fits Chrysler engines.**

- 66417C ..... 5/16", LA 273-360, hydraulic
  - 66418C ..... 5/16", LA 273-360, adj. mechanical
  - 66419C ..... 3/8", B 383-400, adj. hydraulic
  - 66420C ..... 3/8", B 383-400, adj. mechanical
  - 66421C ..... 3/8", RB 413-426-440, adj. hydraulic
  - 66422C ..... 3/8", RB 413-426-440, mechanical
- Fits Ford 289-302 engines. Heat-treated. 16 pieces.**
- 66425C ..... 3/8", FE-Ford, adj. mech. shell
  - 66426C ..... 3/8", FE-Ford, adj. hydraulic



## High - Performance Pushrods

### 1-Piece Pushrod Sets

Premium high-grade steel. Tips welded on, not pressed on. Heat treated for use with guide plates.

- Fits Chevy Small Block and V6/90°.**
  - 66889C ..... 5/16" +.100 S/B
  - 66890C ..... 5/16" Stock Length
- Fits Chevy Big Block.**
- 66894C ..... 3/8" Stock Length





## High Performance Electric Fans

These fans help prevent overheating in stop-and-go traffic, designed to fit the most popular cars and trucks, increase gas mileage, improve engine performance, free the waterpump pulley for more RPM, and install in minutes with simple hand tools. Ultra thin design to fit cramped locations. Reinforced glass filled polypropylene blade and plastic housing for minimized weight. Nylon tie mounting kit included. Nominal fan size is based upon approximate overall assembly diameter.

### S-Blade Fans

- A. 67011.....10-inch Electric Fan
- B. 67013.....12-inch Electric Fan
- C. 67018.....14-inch Electric Fan
- D. 67027.....16-inch Electric Fan

### Straight Blade Fans

- E. 67010.....10-inch Electric Fan
- F. 67012.....12-inch Electric Fan
- G. 67014.....14-inch Electric Fan
- H. 67016.....16-inch Electric Fan

## Adjustable Electric Fan Controllers

PROFORM's premium adjustable fan controllers make adding a thermostat to your cooling system easy. Fan activation is adjustable between 150 and 240 degrees F. These fan controllers are recommended for race and street applications.

69598.....Thread-in Probe Controller

69599.....Push-in Probe Controller

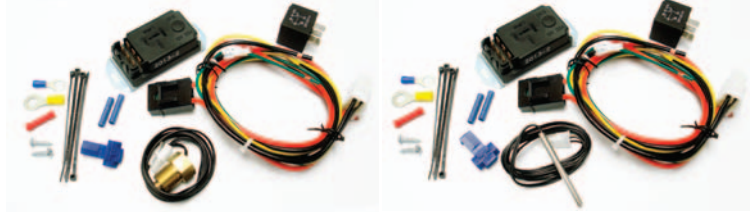

A.



B.



C.

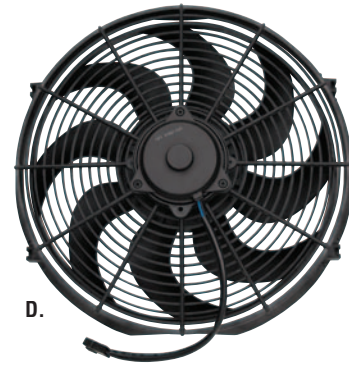

D.



E.



F.



G.

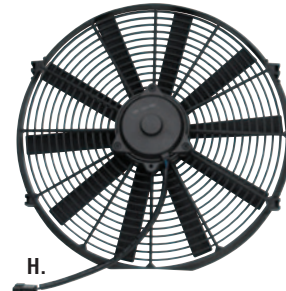

H.

Diameter	10"	12"	14"	16"
Thickness	2-1/2"	2-1/2"	4"	4"
Motor RPM	3000	3000	2500	2000
AMP Draw	7	7	8	9
Fuse Size AMP	25	25	30	30
CFM	1000	1200	1650	2100



## 15" Electric Fans with Thermostat

Your stock fan robs your engine of up to 15 or more horsepower! Replace it with a rugged fan equipped with an adjustable 180°-240°F thermostat. Bolts to your radiator supports using sturdy brackets. With a heavy-duty motor, and 15" diameter, this unit pulls up to 2,800 cfm of air, cooling vehicles with up to 250+ HP (without air) and 220+ HP (with air). Overall: 18" x 16-1/8" x 4". Amp draw, 14 amps.

67015.....Straight Blade 15" Mustang Fan w/ Thermostat

67028.....S-Blade 15" Mustang Fan w/ Thermostat

67017.....Straight Blade 15" Universal Fan w/ Thermostat

67029.....S-Blade 15" Universal Fan w/ Thermostat





# BOSCH

## Bosch® premium auto parts now available from Specialty Auto Parts U.S.A., Inc.

When it comes to premium auto parts and great value, consumers think PROFORM®, because for over 30 years that's what we've been known for. Bosch-level quality has always been seen throughout PROFORM's line of ignition, cooling, and valve train parts, making this expansion a logical one. Purchasers can now get a small selection of aftermarket Bosch branded parts through Specialty Auto Parts U.S.A. This is just another way Specialty Auto Parts U.S.A. is making quality parts available for enthusiasts to get their ride out of the garage and onto the road.

### Universal, External, Inline Fuel Pump

Accurate and consistent fuel pressure is critical to maintaining the performance of your hot rod. This popular fuel pump can support vehicles producing up to 600-700 hp while providing 80 GPH at 72.5 PSI. Other specs are 12 volt minimum current, 80 GPH min. flow at outlet, 8 GPH high temperature reduction, and it weighs 2.27 lbs.

**61944.....Universal, External, Inline Fuel Pump**



### Canister Style Ignition Coil

The original blue Bosch 12 volt ignition coil has a proven record of reliability. This is compatible with points distributor systems. Bosch blue coils have the 3 ohm ballast resistor inside the coil. Mounting bracket is included.

**00012.....Blue 12V Ignition Coil**



### Electric Intercooler Water Pump

There's something about cool crisp morning air, and your supercharger would agree. If you're using a water/air intercooler in your system, then you'll definitely want to consider this water pump to keep your power adder chugging away! Specifications include: ¾" inlet and outlet nipples, and 12 volt. Pigtail not included.

**0392022002.....Electric Intercooler Water Pump**



### LS1/LS6 Spark Plug Wires

To deliver maximum power to the spark plug for a hotter, more powerful, and longer spark; Bosch spiral core spark plug wires are the answer! These 7mm, 6 layer spiro-wound wires have an operating temperature range from -40°F to 428°F. Fits Chevrolet and Pontiac LS1/LS6 applications, 8.5" long. 8 wires per package.

**09448.....7mm LS1/LS6 Spark Plug Wires**



### 100% New Ford Starter

Been running your '97-'98 F150 ragged and need to replace the starter? If so, this 100% new starter offers OE quality and a solid value. Fits '97-'98 4.6L & 5.4L Ford F150's.

**SR7533N.....Ford F150 Starter, '97-'98, 4.6L & 5.4L Engines**



### Chevrolet & Pontiac Replacement Fuel Injector

Your engine's performance will be compromised if your fuel injectors get clogged, which is certainly possible over time. Replacing the fuel injectors will restore your vehicle's performance, maintain fuel economy, and keep your ride in running smoothly. Fits Chevrolet and Pontiac 5.7L engines. 1 fuel injector per package.

**62207.....Fuel Injector for Chevrolet & Pontiac 5.7L Engines**





## Extruded Aluminum Roller- Rocker Arms

Rid your engine of internal friction with roller-tipped rocker arms. The race proven full needle bearing, fulcrum and roller tip not only unleash horsepower, they also lengthen valve train component life and reduce wear and tear on valve stem tips. Precision machined to insure consistency and ratio accuracy. 16 extruded aluminum roller rockers and 16 poly locks.

Fits Chevy small block engines.

- 66907 ..... 1.5 Ratio 3/8" Stud
- 66907C ..... 1.5 Ratio 3/8" Stud
- 66908 ..... 1.6 Ratio 3/8" Stud
- 66908C ..... 1.6 Ratio 3/8" Stud
- 66909 ..... 1.5 Ratio 7/16" Stud
- 66909C ..... 1.5 Ratio 7/16" Stud
- 66910 ..... 1.6 Ratio 7/16" Stud
- 66910C ..... 1.6 Ratio 7/16" Stud
- 66920C ..... 1.5 Ratio 3/8" Stud (8 pcs)  
& 1.6 Ratio 3/8" Stud (8 pcs)



Fits Chevy small block engines w/ center hold-down valve covers.

- 66914 ..... 1.5 Ratio 3/8" Stud, Self Aligning
- 66914C ..... 1.5 Ratio 3/8" Stud, Self Aligning
- 66915 ..... 1.6 Ratio 3/8" Stud, Self Aligning
- 66915C ..... 1.6 Ratio 3/8" Stud, Self Aligning



Part #: 66914

Fits Chevy big block engines.

- 66913 ..... 1.7 Ratio 7/16" Stud
- 66913C ..... 1.7 Ratio 7/16" Stud



Part #: 66913

Fits Ford small block engines.

- 66911 ..... 1.6 Ratio 3/8" Stud
- 66911C ..... 1.6 Ratio 3/8" Stud
- 66912 ..... 1.6 Ratio 7/16" Stud
- 66912C ..... 1.6 Ratio 7/16" Stud

- Fits Ford Aluminum
- S/B Pedestal Mt. '77-'94,
- 302HO & 351W Hyd. &
- Roller Cams.
- 66879 ..... 1.6 Ratio 5/16" Stud
- 66878 ..... 1.7 Ratio 5/16" Stud
- NEW!** 66876... 1.6 Ratio 5/16" Stud (8 pcs)  
& 1.7 Ratio 5/16" Stud (8 pcs)



Part #: 66879

Fits Ford 302 Boss 351C, 429-460.

- 66861C ..... 1.73 Ratio 7/16" Stud

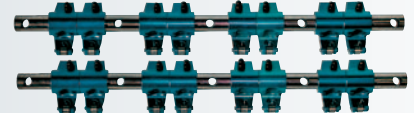

Part #: 66869

Fits Chrysler. Supplied with hardened shaft and hardware.

- 66869 ..... 1.5 Ratio for S/B
- 66868 ..... 1.5 Ratio for B/B
- Fits Oldsmobile 350-455.
- 66860C ..... 1.6 Ratio 7/16" Stud
- Fits AMC 287-401
- 67480 ..... 1.6 Ratio 3/8" Stud
- Fits Pontiac 265-455
- 67481 ..... 1.5 Ratio 7/16" Stud
- 67482 ..... 1.65 Ratio 7/16" Stud

## Heavy-Duty Extruded Aluminum Roller-Rocker Arms

Designed for up to 10,000 RPM. This heavy duty design features an oversized body and fulcrum with a triangulated profile for additional rigidity and strength. Accommodates most oversized valve springs. American-made cage bearings are in self-contained bearing-cups for extra low friction wear. Each set includes 16 extruded aluminum roller rockers and 16 poly locks. If you would like to order a single roller rocker, please use your applicable part number and add a "P" at the end (ie "67708P").

Fits Chevy small block engines.

- 66928 ..... 1.5 Ratio, 3/8" Stud
- 66928C ..... 1.5 Ratio, 3/8" Stud
- 66929 ..... 1.6 Ratio, 3/8" Stud
- 66929C ..... 1.6 Ratio, 3/8" Stud
- 66930 ..... 1.5 Ratio, 7/16" Stud
- 66930C ..... 1.5 Ratio, 7/16" Stud
- 66931 ..... 1.6 Ratio, 7/16" Stud
- 66931C ..... 1.6 Ratio, 7/16" Stud



**NEW!** Buick 455 Shaft-Mounted Billet Aluminum Roller Rockers

Take your Buick valve train to the next level of performance with a friction-reducing roller rocker system. This shaft mounted roller rocker system will fit standard stage 1 and 2 cylinder heads, and is designed for 1.65 Ratio. Please note that the push rod hole many require additional clearance. Premium Race Series rockers include 16 billet aluminum roller rockers with adjusters, two shafts, and all the necessary spacers and mounting hardware.



66864.....Buick 455 Shaft-Mounted Roller Rockers, 1.65 Ratio

Fits Chevy small block.

66950 ..... For use with 3/8" stud

66951 ..... For use with 7/16" stud

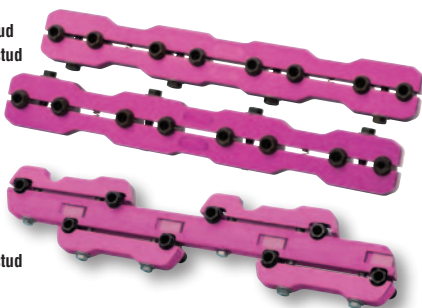

Fits Chevy big block.

66981 ..... For use with 7/16" stud

**Chevy Guide Plates**

Fits Chevrolet small block engines 5/16". Hardened. These precision stampings are carefully formed for exact fit. Each guide plate has been heat treated to increase the hardness and minimize wear. 8 pieces per package. Fits Chevy™ small block.

66880 ..... 5/16" S/B, Flat  
66881 ..... 5/16" S/B, Raised



**Poly Locks for Roller-Rocker Arms**

Fits most extruded aluminum rocker arms. 16 per package.

66935 ..... 3/8"  
66936 ..... 7/16"



**Grooved Balls & Nuts**

Fits most stamped rockers. 3/8"-24 thread studs.  
66924C.....Grooved Balls & Nuts.

**Stamped Roller-Tip Rocker Arms**

The super affordable way to reduce internal valve train friction and valve stem wear. Extra long slot eliminates rocker to stud interference when using high lift cams. 16 rockers, anti-gall grooved balls and nuts per package. Fits Chevy small block engines.

66906B ..... 1.5 Ratio 3/8" Stud  
66906C ..... 1.5 Ratio 3/8" Stud  
66922 ..... 1.6 Ratio 3/8" Stud  
66922C ..... 1.6 Ratio 3/8" Stud



Fits Ford small block, 289-302-351W

66984.....Factory with 7/16" Stud, Edelbrock Victor Jr. & Performer RPM Heads

**Aluminum Stud Girdles**

Stud Girdles reduce flex and part breakage. Increased valve-train rigidity helps minimize energy loss. Each set comes with aluminum stabilizers and poly locks. Two pieces per set.



Fits Ford big block, 429-460

66982.....7/16" Stud, Iron & Aluminum Cobra Jet

**Stamped Rocker Arms**

For use when roller tip is not required. Proven OEM quality.

Fits Chevy small block engines, 16 rockers, ball, and nuts included.

66905 ..... 1.5 Ratio 3/8", extra long slot

Fits Chevy big block engines, 16 rockers, ball, and nuts included.

66921 ..... 1.7 Ratio 7/16", extra long slot



Fits Chrysler Small-block

66872..... 1.5 Ratio, set includes 16 rockers

66866.....Hardened Shaft for B/B, 1-pc

66867.....Hardened Shaft for S/B, 1-pc

**Rocker & Pushrod Kits**

Rocker (Long Slot) & Heat-Treated Pushrod Kit.

Fits Chevy small block engines.

66923C ..... 1.5 Ratio, 3/8" Stud





### Adjustable Reinforced Aluminum Rear End Covers

Reinforced lightweight aluminum rear end covers designed to strengthen the rear housing case in heavy torque situations.

The PERFECT LAUNCH® logo is prominently displayed on a precision milled surface. Each cover includes two bolts to stabilize bearing main caps, fluid capacity and magnetic drain plugs, and mounting bolts. All covers have a black painted finish.



- A. 66667.....GM, 7.5
- B. 66668.....GM, 10 bolt
- C. 69502.....GM, 12 bolt
- D. 69501 .....Ford, 8.8
- E. 69504.....Dana 60



### Adjustable Pinion Snubbers

These simple devices help control wheel hop, and also keep the rear axle from rotating during hard accelerations.

- A. 68080.....Mustang '85-'93
- B. 68081 **NEW!**.....Dana 60

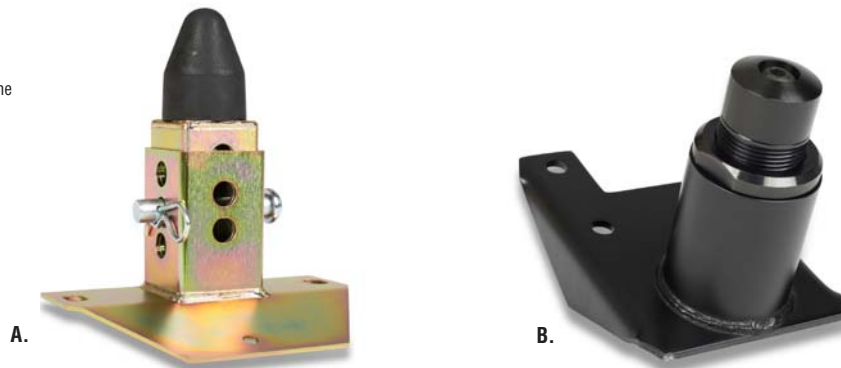

### FREE! Perfect Launch® Practice Tree App!

Practice your reaction time, and then challenge a friend to try and beat your time! Can you nail a Perfect Launch? Watch out, if you're slow you'll get laughed off the track!

Lay the smack down on this drag racing practice tree, and let your friends know who has the fastest reaction time in the land! Challenge friends by SMS or Email to get the competition going every month. The leaderboard refreshes every month, so get your name to the top of the first page if you've got skills. If you're slow you'll get laughed right off the track, so start practicing and put up some times that are worth letting people know about!



Challenge Friends by SMS or Email!

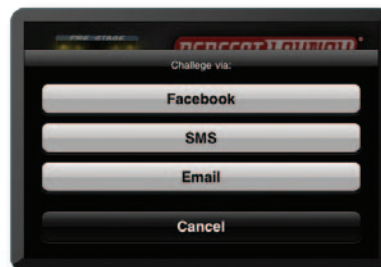

**PERFECT LAUNCH®**

Top 20 Scores for October 2012

Username	Score
Rizky Assa_G5	0.001
JB	0.002
Ivantheterrible1	0.002
agungBS_G5	0.002
XDRManAZ	0.003

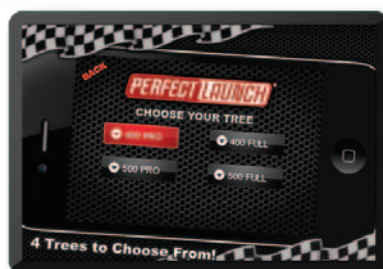

### Perfect Launch® Drag Racing Tree

With this shirt-pocket sized PERFECT LAUNCH® portable "Christmas Tree," you can perfect your launch skills and reaction time almost anywhere...learning to hit 0.000 out of the - "bleach box" numbers at the track. This precision portable electronic device (4.5" x 2.75" x 1") makes a perfect affordable gift for the pro-racer, would-be racer, or anyone who just likes the thrill of competition. The PERFECT LAUNCH® reaction timer features a remote thumb trigger, .4 and .5-second PRO and FULL trees, plus an adjustable delay box, bump down and roll out. If you're not familiar with those terms, the included instructions will have you pounding the "win" lights in no time. Included 9-volt powered PERFECT LAUNCH® shuts down automatically (no chute required!) for longer battery life and it's affordable FUN!

67025C ..... Perfect Launch practice tree





# A New Standard in Header Bolts, and Now Collector Bolts!

Curiously simple! Amazingly effective!

## Applications:

- GM V8, S/B, LS, 1/4" flange [66754], 3/8" flange [66755]
- GM V6, SB 265-400, Buick, Olds, Pontiac '79 & earlier [66751, 66753]
- GM BB 396-502 exc 348 & 409 66752, 66756
- Ford 5.0L, SB 289-302-351W 66752, 66756
- Mopar BB 383-440 (exc 413) 66751, 66753
- Mopar 413 66752, 66756
- AMC V8's w 3/8" bolts [66751, 66753]

Each PROFORM® Grade 8 (or 12.9 Class) Header Bolt is permanently assembled with a set of special washers. When sufficiently torqued, the washers' super-hardened external serrated teeth bite into and grip the bottom of the bolt head and the top surface of the header. After being self-locked in this manner, any bolt-loosening rotational movement is blocked by the wedge-locking action created by the washers' interfacing, matching cams. Loosening the bolt is literally an uphill climb: vibration that might ordinarily loosen the bolt actually increases the wedge-locking tension, keeping the bolt secure. Because this simple wedge-locking method uses tension instead of friction, contact with oil actually facilitates the wedge effect. When changing headers, PROFORM Header Bolts can be untightened with a normal wrench, lubricated, and reused.

Seriously...are you still spending too much of your hard earned money on bolts that require pins and clips that fly around the garage, or adhesive fluids? All that extra expense in hopes that your header bolts won't loosen up over time? PROFORM has a simple and affordable solution that will lock those headers up.

NOTE for 3/8" bolts: 3/4" L most often used for cast iron heads. 1" L recommended for aluminum heads.

**NOTE: 8mm bolts have a lustrous nickel plated finish. 3/8" bolts are finished in black oxide.**

- 66751.....Cam Locking Header Bolts 12 pcs, 3/4" L x 3/8"
- 66752.....Cam Locking Header Bolts 16 pcs, 3/4" L x 3/8"
- 66753.....Cam Locking Header Bolts 12 pcs, 1" L x 3/8"
- 66754.....**NEW!** Cam Locking Header Bolts 12 pcs, LS, .984" L x 8mm
- 66755.....**NEW!** Cam Locking Header Bolts 12 pcs, LS, 1.181" L x 8mm
- 66756.....**NEW!** Cam Locking Header Bolts 16 pcs, 1" L x 3/8"
- 31070.....5 Set Header Bolt Display Rack\*
- 31071.....8 Set Header Bolt Display Rack\*
- 31072.....12 Set Header Bolt Display Rack\*



\*Demonstration device included  
31061...Portable Demonstration Device  
31060...In-Store Mountable Demonstration Device

## NEW! Cam Locking Collector Bolts

Exhaust collector bolts tend to get loose...NO MORE! The latest addition to Proform's line of locking bolts will keep those exhaust collectors from getting loose. The kit includes six grade 8 bolts and nuts with a black oxide finish, and twelve pairs of cam locking washers to secure the assembly.

66757 **NEW!**....Cam Locking Header Bolts & Nuts 6 pcs

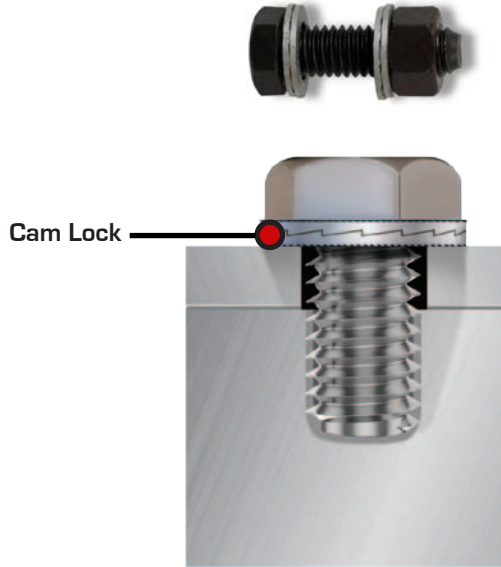

### Harmonic Balancers

Fits Chevy small and big block engines. These are brand-new OE replacement harmonic balancers. Affordable pricing eliminates the need to clean your old stock balancer. Enhance your balancer by adding the patented balancer covers on page 16.



66508 ..... B/B 396



66509 ..... S/B 350 - Cntr Timing Mark 6-3/4"



66510 ..... S/B - Internal 6-3/4"



66511 ..... S/B - Internal 8"



66512 ..... B/B 454 (pre-'89) - External

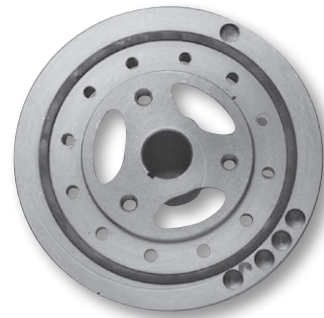

66513 ..... S/B 400 - External

### High-Performance Gear Drives

For Chevrolet applications. These rugged gear drives offer high-precision timing, eliminating chain stretch. Machined for noise. Easy to install, fits under stock timing covers. Includes locking plate, offset cam bushings, roller cam bearing, and bronze thrust bearing.



- 66917C ..... S/B
- 66918C ..... B/B

### Brass Freeze Plug Kits

Avoid corrosion in your engine and replace your rusty freeze plugs with PROFORM's durable brass freeze plug kits. All necessary plugs are included for one complete engine block.

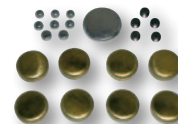

- |                                |                              |
|--------------------------------|------------------------------|
| 66550 ..... Chevy SB 283-350   | 66556 ..... Ford 429-460     |
| 66551 ..... Chevy SB 400       | 66557 ..... Chrysler 318-360 |
| 66552 ..... Chevy BB 396-454   | 66558 ..... Chrysler 383-440 |
| 66553 ..... Ford 289-302-351W  | 66559 ..... Oldsmobile V8    |
| 66554 ..... Ford 352-390-428   | 66560 ..... Pontiac V8       |
| 66555 ..... Ford 351C-351M-400 |                              |

Now Available! Freeze Plug Installer Kit, p. 79

### Locking Transmission Dipsticks

- A. 66175 ..... GM Turbo 350 Trans Dipstick, Chrome
- B. 66178 ..... GM Turbo 400 Trans Dipstick, Chrome
- C. 66181 ..... GM Turbo 350 Trans Dipstick
- D. 66182 ..... GM Turbo 400 Trans Dipstick
- 66172 ..... GM Powerglide, Long
- 66173 ..... GM Powerglide, Short

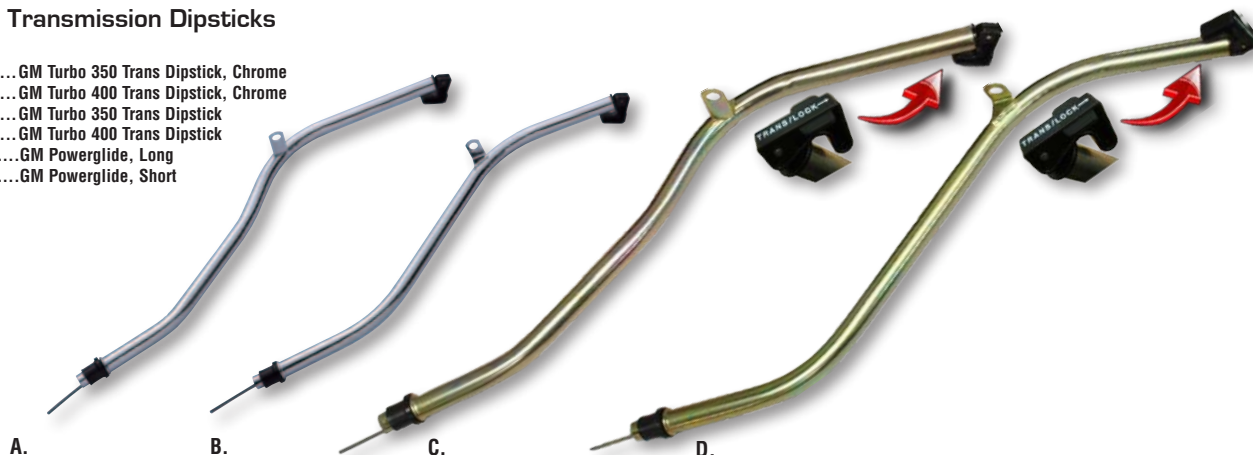



## Digital Programmable Shift Lights

Easy to set digital shift lights will help you leave your competition eating exhaust at the track! Proform's Mini Digital Shift Lights can be easily installed in vehicles with 1-12 cylinders. Both models use an easy 3-wire hookup, but in the case of the wireless model, it's a transmitter under the hood that's hooked up. The following applies to both models. Measuring at only 4 1/4" long, these 3 LED lights will give you the signal when it's time to shift! All settings are easily controlled with two buttons. Additional shared features include 100-12,000 RPM range in 100 RPM increments, cylinder range of 1 to 12, adjustable brightness for the digital display, and a display on/off feature when in use.

- Easy mounting
- Small enough to fit in tight places
- Easy 3-wire hookup
- Adjustable display brightness

67007C.....Mini Digital Shift Light, Black  
 67006C.....Wireless Mini Digital Shift Light, Black  
 Some applications may need a late-model tach adapter



**AFFORDABLE!**



**Wireless Version  
 Now Available!**



## Adjustable RPM Shift Lights

Adjustable RPM Shift Light. Affordable performance: Set shift point without a tachometer! Dial in desired shift point – light flashes on. At pre-set RPM, light will flash on. Range is 3-12,000 (X200) RPM. No racing tach needed! Does not require separately purchased RPM modules! Some applications may need a late-model tach adapter.

- A. 67005SC ...Shift Light, Silver, 5" W x 2.75" H w/base  
 B. 67005C.....Shift Light, Black, 5" W x 2.75" H w/base  
**Suffix "C" = Clamshell Packaging**



A.



B.

## Mustang Parts

### Oil Pans, Pick-ups, and Dipstick.

Fits '81 and later Mustangs, T-Birds, and Cougars. Rear sump is 8-1/4" deep, zinc iridite.

#### For 289-302 Engines

68050...7-Quart Ford S/B Oil Pan

68051...Oil Pick-up for 68050

68052...Stainless Steel Flexible Oil Dipstick for 68050

#### For 351W Engines

68053...7-Quart Ford S/B Oil Pan

68054...Oil Pick-up for 68053

68052...Stainless Steel Flexible Oil Dipstick for 68053

### Stainless Steel Flexible Dipsticks for 289/302/351W/429/460

68052....Oil Pan, Screw-in, 5/8"-18, 289/302/351W/429/460

68056....Timing Cover, Press-in, 289/302/351W

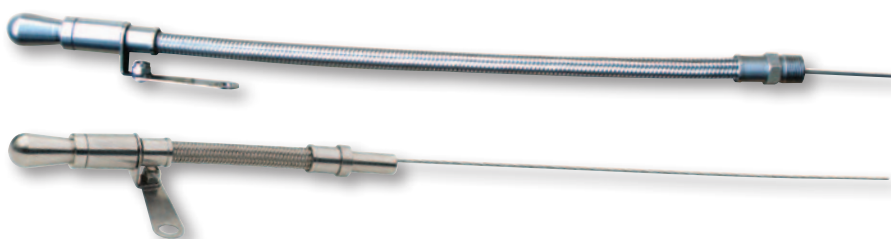

### Heavy Duty Mustang Control Arms

Kit includes upper and lower rear control arms. Strengthen your Mustang suspension by replacing your "flimsy" control arms with our strong .120" wall control arms.

68070 ..... Mustang '79-98

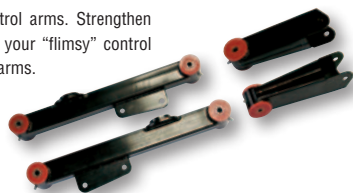

### Adjustable Pinion Snubber

This simple device helps you control wheel hop. They will also help keep the rear axle from rotating during hard acceleration.

68080 ..... Mustang '85-93



### Air Pump Idler Bracket\*

This unit is a direct bolt-in when you eliminate the air pump. Uses standard serpentine belt.

68110 ..... 302 & 351 Mustangs



\*Product is legal only for off-highway use (except in CA or states that have adopted CA emission standards), racing use or for use on pre-emission-controlled motor vehicle/engines (pre-1966 domestic vehicles certified to CA standards, pre-1968 domestic vehicles certified to federal standards and all pre-1968 foreign vehicles), per manufacturer's application guide.

### Ford Small-Block Electric Water Pumps

Billet Backing Plate Included.



Fitting for Water pump Included.

Reference Page 44 for more info.

### 15-inch Mustang 5.0 Fan w/ Thermostat

Your stock fan robs your engine of up to 15 or more horsepower! Replace it with a rugged, universal-fit fan equipped with an adjustable 180°-240°F thermostat. Bolts to your radiator supports using sturdy brackets. With a heavy-duty motor, highly angled blades, and 15" diameter, this unit pulls up to 2,800 cfm of air, cooling vehicles with up to 250+ HP (without air) and 220+ HP (with air). Overall: 18" x 16-1/8" x 4".

67015...15" Mustang Fan with Thermostat



67028.....S-Blade 15" Mustang Fan w/ Thermostat



### Additional Mustang Parts

66270...Ford SB/BB V8, 1.4 KW, auto trans, high output starter

66442...Ford '65 - '86 with 61 AMP chrome alternator case kit

66271...Ford SB/BB V8, 1.4 KW, std trans, high output starter

66911...Ford Alum Rocker Arms 1.6 Ratio, 3/8" stud.

66911C.Ford Alum Rocker Arms 1.6 Ratio, 3/8" stud. Clam. pkg.

66912...Ford Alum Rocker Arms 1.6 Ratio, 7/16" stud.

66912C.Ford Alum Rocker Arms 1.6 Ratio, 7/16" stud. Clam. pkg.

66425C.Ford 289-302 2-pc pushrods, 3/8" adj. mech. shell.

66426C.Ford 289-302 2-pc pushrods, 3/8" adj. hydraulic.

See also Ford HEI Distributors on page 47.



### Harmonic Balancer Covers

U.S. Patent 5,675,078. Check out GM Performance Parts equivalent on page 16.

- |                           |                           |
|---------------------------|---------------------------|
| <b>6-3/4" Chevy™ S/B</b>  | <b>8" Chevy™ S/B</b>      |
| 66517BC.....Blue          | 66518BC.....Blue          |
| 66517BKC.....Black        | 66518BKC.....Black        |
| 66517BLTC.....Billet look | 66518BLTC.....Billet Look |
| 66517CC.....Chrome        | 66518CC.....Chrome        |
| 66517RC.....Red           | 66518RC.....Red           |

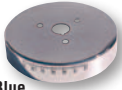

### Push-In Air Breather Caps\*

- 66008 ..... Fits 1.22" hole, 3" dia.
- 66017 ..... W/PVC tube, fits 1.22" hole, 3" dia.
- 66035 ..... 3/4" OD Neck for PCV hole, 3" dia.



### NEW! Carbon-Style 3" Breather Cap\*

Top off your GM or Ford Carbon-style valve covers with a matching breather cap! Please Note: breather is steel with a decorative finish.

- 66013 ..... Push-in, 3" dia., Carbon-style



### Push-On Air Breather Caps\*

- 66009 ..... Fits filler tubes



### Twist-On Air Breather Caps\*

- 66012 ..... With PCV tube, same fit as 66010



### Oil Filler Caps

- 66018 ..... Fits 1-1/4" dia. hole
- 66632 ..... Deluxe Twist-On: Most GM & Chry.



### Oil Filler Tube

- 66020 ..... Fits Chevy S/B



### Air Cleaner Adapters

- 66315 ..... 5-1/8" to 4-7/32" Carb Neck



### No-Mess Oil Pan Drain Plug-Patented

The PROFORM engine oil drain plug has a unique, patented, rubber extension which acts as a sealing "cork" when changing engine oil. As the drain plug is unscrewed and loosened, the "cork" seals the threaded drain hole, reducing mess and contact with hot oil. A firm tug releases the oil when desired. This plug minimizes the chance of a plug being dropped. U.S. Patent 5,547,042.



- 66960 ..... Oil Drain Plug, 1/2"-20
- 66960C ..... Oil Drain Plug, clipstrip of six (6)

### Air Cleaner Kits & Accessories

These air cleaners are computer designed for optimum fit and maximum operating efficiency. They are triple chrome plated using prepolished steel for a brilliant show-car finish, and they incorporate high CFM-rated flame-retardant paper filters for maximum air flow.

### 14-inch Super-Light Aluminum Air Cleaner

SAVE critical front-end weight with PROFORM's race-winning super-light air cleaner kits! This clear anodized finish kit includes paper filter and the popular deeply-recessed base. 3" Paper Filter Included..



- 66809 ..... 14" Super-Light Aluminum Air Cleaner Kit.
- 66808 ..... 14" Super-Light Aluminum Air Cleaner Base.
- 66810 ..... 14" Super-Light Black Alum. A/C Base.

### 14" Deluxe Low Profile Air Cleaner

Fits 5-1/8" and 4-7/32" Carb Necks. Has recessed base for low profile fit over carburetor. Includes 4-7/32" Adapter, 2 Plated Studs, Tri-Star Wing Nut, PCV Attachment for use on Pollution Controlled Vehicles, 3" Paper Filter and Installation Instructions.

- 66801 ..... 14" Deluxe Air Cleaner



### 14" Standard Full-Flo Style Air Cleaner

Fits 5-1/8" and 4-7/32" Carb Necks. The recessed area in the center of the top is chrome plated, the bottom is chrome plated, not just zinc plated like competitors' air cleaners, and the knock-out area for the adapter is flat. Includes Dual Jet Adapter, Plated Stud, Wing Nut, PCV Attachment for use on Pollution Controlled Motor Vehicles, a 2-1/4" Paper Filter and Installation Instructions.

- 66804 ..... 14" Std. Air Cleaner



### 10" Deluxe Low Profile Air Cleaner

Fits 5-1/8" and 4-7/32" Carb Necks. Has recessed base for low profile fit over carburetor. Includes 4-7/32" Adapter, Plated Studs, Tri-Star Wing Nut, PCV Attachment for use on Pollution Controlled Vehicles, 2" Paper Filter and Installation Instructions.

- 66802 ..... 10" Deluxe Air Cleaner



### 9" Standard Full-Flo Air Cleaner

Fits 5-1/8" Carb Necks. Includes Plated Studs, Wing Nut, PCV Attachment for use on Pollution Controlled Motor Vehicles, 2" Paper Filter and Instructions.

- 66815 ..... 9" Std. Air Cleaner



### Black Oxide Header Bolts

Hex Head. 12 per package.

- 66342 ..... 3/8" x 16-1"



### Chrysler B/B Timing Chain Covers

Stock height steel timing chain cover with timing tab included. Fits 383-440.

- 66193 ..... Chrome
- 66194 ..... Black

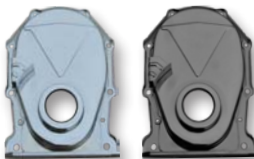

### Fuel Pump Block Off Plates w/ Gasket

- 66106 ..... Chevy S/B
- 66107 ..... Chevy B/B & Most V6; Ford 289-302; Chrysler 273-440



### Fly Wheel Cover

- 66621 ..... Fits Chevy S/B with Turbo 350 or 400 Transmissions



### Oil Dipstick & Tube Kits

- 66116 ..... Chevy S/B thru '77



- 66130 ..... Chevy S/B 1978 - 82



- NEW!** 66134 ..... Chevy S/B thru '77, flex stainless



- 66117 ..... Chevy B/B engines



- 66629 ..... Pontiac '55 - 79



- 68052 ..... Ford 302/351W/429/460, stainless, flex., screw-in



- NEW!** 68056 ..... Ford 289-351W, stainless, flex, timing cover, press-in



- 66184 ..... Ford S/B engines and 351W



- 66618 ..... Ford Cleveland



- 66142 ..... Chrysler 273-360



- 66183 ..... Chrysler B/B engine 361-440, Except Hemi

### Transmission Dipstick

- 66118 ..... GM Turbo 350
- 66119 ..... GM Turbo 400



### Engine Dress-Up Kits

PROFORM Dress-Up Kits contain factory-style oil restricting baffles in the valve covers. All steel components are richly chrome plated. All Chevy kits contain 2 Valve Covers, Stock-Height with Baffle; 1 Push-In Air Breather, 1 Dipstick with Tube, 1 Rubber Grommet for PCV, 1 Rubber Grommet for Air Breather, plus the parts listed below:

**Timing Chain Cover with Oil Seal, 1 Timing Tab**

- 66851 ..... Chevy S/B

**8 Deluxe Wing Bolts w/ Studs; 8 Valve Cvr. Hold Down Clamps**

- 66853 ..... Chevy S/B (not shown)

**Timing Chain Cover with Oil Seal, 1 Timing Tab**

- 66855 ..... Chevy B/B (not shown)

**14 Deluxe Wing Bolts w/ Studs; 2 Wire Looms.**

- 66857 ..... Chevy B/B (not shown)

**Each kit below contains:** 2 Valve Covers, Stock-Height with Baffle; 1 Rubber Grommet for PCV, 1 Rubber Grommet for Air Breather, plus the parts listed:

1 Push-In Air Breather, 2 sets of Ford Racing Wire Looms, 12

Deluxe Wing Bolts w/ Studs 12 Hold-Down Washers

- 66863 ..... Ford 289, 302, 351W (not shown)

1 Dipstick with Tube, 1 Rectangular Air Breather

8 Deluxe Wing Bolts w/ Studs, 8 Hold-Down Washers

- 66865 ..... Pontiac 301-455

### Carburetor Studs

Supplied with Lock Washers & Nuts. 4 per package.  
 66338 .....Length: 1-3/8"  
 66339 .....Length: 1-1/2"  
 66340 .....Length: 2"

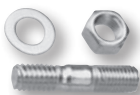

### Carburetor Return Spring Brackets

66616 ..... Most Ford



### Grommets

66007 .....1 Air Breather & 1 PCV grommet



### Flange Hold Downs

For Chevy small block, Chevy big block (exhaust side), Ford small block (exhaust side) 351C and 351M (intake side). 3" long. 4 per package.

66002 .....Hold-Down Clamps

For all stamped valve covers. 8 per package.

66003 .....Hold-Down Washers



### Chevrolet Timing Tabs

66108 .....S/B: 7" Balancer

66121 .....S/B: 8" Balancer

66109 .....B/B: 8" Balancer



### Transmission Oil Pans

66154 .....GM 350 Turbo



### Oil Pump Shaft

Fits Chevrolet Small Block

66919C .....Oil Pump Shaft



### Neoprene Rubber & Steel Valve Cover Gasket



For Chevy small block, this steel reinforced rubber gasket resists blowout and allows for reuse after valve cover removal. Sold in pairs.

66001 .....Rubber/Steel Gasket

### Hood Pin Kit

Includes 2 Stainless Steel Scuff Plates, Safety Pins and all necessary Mounting Hardware.

66649 .....Hood Pin Kit



### Street Oil Pans

**Technical Note:** Also fits '80-84 with driver-side dipstick.

Will not fit 302 Hi-Perf.

66162 .....Chevy S/B, 1965-79

**Technical Note:** Fits engines with passenger side dipsticks.  
 66132 .....Chevy S/B, 1980-84 (not shown)

**Technical Note:** Fits 396-454 Chevy Big Block Engines & Chassis, except '62-67 Chevy II, some Chevelles, Vega & Monza.

66611 .....Chevy B/B

66187 .....Ford S/B: 221, 260, 289 & 302 (not shown)

**Technical Note:** Fits most '66 & later production chassis with 361 - 440 Big Block and 426 Street Hemi Engines. 5 Quart Capacity. 66189 .....Chrysler B/B



### Low Profile, Hi-Capacity Oil Pans

7-Quart Chevrolet Small Block

66164 .....Orange

66167 .....Chrome (not shown)

66160 .....Oil Pick-up for 66164/66167



### Timing Chain Products

Chevrolet Timing Chain Covers. Supplied with oil seal.

66151 .....S/B, 10 bolts

66153 .....B/B, 10 bolts

Save hours of labor with no need to drop the oil pan to check the chain and gears. Supplied with mounting bolts, beaded mid-line gasket, reusable steel-reinforced U-gasket, installation instructions.

66666 .....S/B, 2-pc design.



### T-Bar Wing Nuts

"Wide-Shoulder" ends allow improved load-distribution to prevent vacuum leaks and our 1-1/4" x 20 studs accommodate the thickest racing gaskets with plenty of thread revolution to spare. 4 per package.

66004 .....5" High

66005 .....3-1/2"



### Deluxe Wing Nuts

Hex-head/wing design. Shaft and shoulder design same as PROFORM P/N's 66004/66005. 5" High. 4 per package.

66006 .....1/4" x 20 Stud

66036 .....5/16" x 18 Stud



### Hi-Torque Mini Nuts

Steel mini nuts, clean look, may be selected when more torque is required to prevent leaks. 1-1/2" high. 4 per pkg.

66038 .....1/4" x 20 Stud



### Aluminum Mini Nuts

1/4" x 20 with Stainless Steel washers. For an uncluttered, highly distinctive look. 4 per package. 66650 .....Chrome

66653 .....Blue



### Intake Manifold & Waterpump Pipe Fittings

For Chevrolet Small and Big Block Engines.

66369 .....Intake

66365 .....Water Pump



### Water Necks

Easily installed in place of OEM parts. Supplied with bolts, gaskets or O-rings.

66207 .....All Mopar, Chevy

V8 & 90-Degree V6 (must use Mopar thermostat)

66211 .....Ford 289, 302, and 351W '65-75

66209 .....Chevy V8 '55-'65,

Chevy II V8 '64, and

Corvette '56-'63

66210 .....Chevy, Camaro,

and Chevelle V8s '66-'75

66212 .....Pontiac V8 '64-81



### Valve Covers

Computer-designed for precise fit and positive seal to prevent leaks. We employ thicker upgraded steel, polished to a brilliant luster. All valve covers are supplied with OEM style oil restricting baffles, unless stated otherwise. Sold in pairs.

**Technical Note:** Heads modified with stud girdles may not clear baffle in tall valve covers. Check clearance before purchasing

#### Chevrolet

66704 .....PROFORM 2-Pc valve covers, Chevy S/B,

polished, plain, equivalent to 141-915

66735 .....2-Piece valve cover replacement gasket kit (2)



66702 .....S/B: 265-400, Short



66706 .....S/B: 265-400, Tall w/ baffle



66710 .....B/B: 396-454, Short

Ford

66724 .....Windsor: Fits 289, 302, Short 351W (not shown)

Other



66742 .....Chrysler B/B: Fits 361-440, Tall (not shown)

66732 .....Pontiac: Fits 301-455, Tall (not shown)

### One-Piece Valve Cover Hold Downs



Fits Chevrolet small block stamped valve covers. Easily dropped into position, these revolutionary one-piece hold-downs are fast to install, eliminating fumbling with four separate flange reinforcement clamps. By applying additional downward pressure nearer to the valve cover ends, this popular invention minimizes the possibility of oil leakage. Sold in pairs. U.S. Patent No. 4,821,699.

66291CC .....Chrome

66291BC .....Blue

66291BKC .....Black

66291RC .....Red



Same as 66291 hold-downs, but with the added advantage of attached linear wire-looms for even more efficient installation.

66292CC .....Chrome

66292BC .....Blue

66292BKC .....Black

66292RC .....Red





### Soft Conforming Aluminum Collector Gasket Kits

PROFORM's soft conforming aluminum gaskets easily conform to the collector flanges for a superior seal. Durable, theft-resistant clamshell packaging. Each kit comes with 2 gaskets and six nuts and bolts.

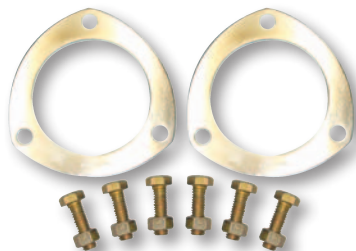

- 67920 ..... Aluminum, 2.5-inch collector gasket kit
- 67927 ..... Aluminum, 3-inch collector gasket kit
- 67928 ..... Aluminum, 3.5-inch collector gasket kit

### Soft Conforming Aluminum Header Gasket Kits

PROFORM's soft conforming aluminum gaskets easily conform to the header flanges for a superior seal. Durable, theft-resistant clamshell packaging. Each kit comes with 2 gaskets.

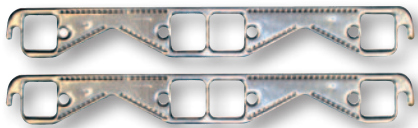

- 67921 ..... Chevy, S/B, Aluminum header gasket, square port
- 67923 ..... Chevy, B/B, Aluminum header gasket, square port (2.125")
- 67929 ..... Chrysler, S/B, Aluminum header gasket, 273-360
- 67932 ..... Ford, S/B, Aluminum header gasket, round port
- 67933 ..... Ford, S/B, Aluminum header gasket, square port

### PROFORM Key Chains

Not your everyday key chains, these PROFORM key chains are precision-machined from billet aluminum stock for a superrealistic look, and then hand-assembled and offered as a moveable piston, an aluminum stock car wheel with a racing tire, and an air cleaner kit (which can hold two quarters for emergency use).



- 31012 ..... Piston Rod Key Chains (20 ct. bag)
- 31018 ..... Tire & Wheel Key Chains (20 ct. bag)
- 31019 ..... Air Cleaner Key Chains (20 ct. bag)
- 31011 ..... Fishbowl Merchandiser with 20 Key Chain
- 31015 ..... 12-pc Piston Rod Key Chains on Clipstrip
- 31016 ..... 12-pc Tire & Wheel Key Chains on Clipstrip
- 31017 ..... 12-pc Air Cleaner Key Chains on Clipstrip

### PROFORM Banners

- 31020 ..... 3'x6' PROFORM Banner
- 31022 ..... 2'x4' PROFORM Banner



### PROFORM Decals

Available in a popular die-cut version, approximately 1-1/2"x7". Perfect for parts or vehicle application. Also offered in traditional 3"x9" rectangular size (approx). Offered in packages of 3.

- 31021 ..... 3 Die-Cut Decals
- 31025 ..... 1 PROFORM Auth. Dealer Door Window Decal
- 31026 ..... 3"x9" Contingency Decal

### Buick and AMC Timing Chain Covers

These die-cast timing chain covers are 100% new and optimize the OEM design. Crankshaft oil seal included

- A. 69510 ..... Buick front timing cover, 400-430-455 V8, 1967-'76
- B. 69500 ..... AMC front timing cover, 304-360-401 V8

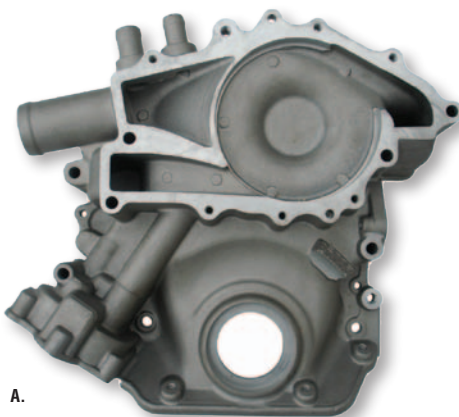

A.



B.

### A Little Bling for your Ring!

Everybody love keychains, especially ones emblazoned with Big 3 emblems. Bucket includes 25 Bowtie, 10 Ford, and 5 Mopar keychains. Keychains measure 1-5/8" in length making them small enough to fit on a keyring. Don't let those POP dollars pass you by. Inquire with your wholesale distributor for more information.



- 31008 ..... Big 3 Bucket with 40 keychains

### Proform Caps and Tee's



Front

Back

### MOPAR® Piston Rod Keychain



- 440-970 ..... MOPAR Piston Rod Keychain

### 2017 PROFORM Catalogs

88 pages jam-packed with over 1000 innovative performance parts! You'll find everything from the wildly popular Race Series carburetors, to the proven HEI distributors, to Licensed Chevrolet Performance Parts and Ford Performance dress-up parts. You'll also find over 20 pages of hot-selling, affordable engine building tools! Please use the part numbers below when ordering.



- 31031P ..... PROFORM catalog, single copy
- 31031 ..... PROFORM catalog, 1 case, 110-ct (wholesale only)
- 31004 ..... PROFORM catalog countertop display box with 20 catalogs



# TOOLS by **PROFORM**

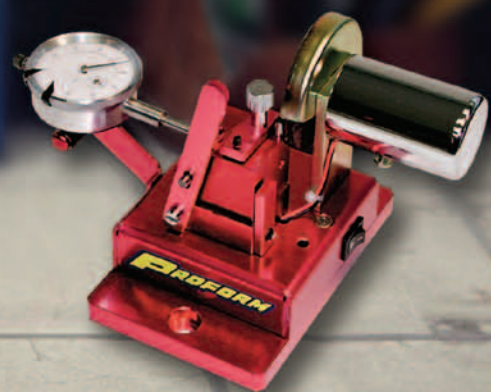
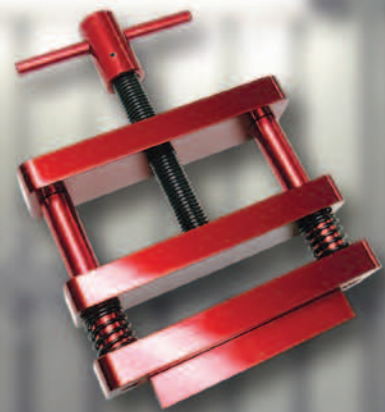



# SCALES

## Digital Engine Balancing Scale

These precision scales are perfect for balancing pistons, rods, clutch weights, etc. Digital models are powered by one 9-volt battery or an optional AC adapter. Use with Connecting Rod Balancer, P/N 66844.

- 66466 .....2000G x 1G
- 66467 .....3000G x 1G
- 66473 .....2000G x 0.1G

**AC Adapter for engine balancing scales,**

P/Ns 66466, 66467, 66473.

**66468 .....AC Adapter**

**Digital Scale Carrying Case,**

Foam Padded for extra safety.

Fits P/Ns 66466, 66467, 66473.

**66469 .....Case**



## 5000 lb. Vehicle Weighing Scale

PROFORM's vehicle scale features weight and percentage for each wheel and total vehicle weight. The individual scale pads are 14 1/2" x 9 1/2" x 2 1/2" with a 1,250 lb.capacity per pad for a total scale capacity of 5,000 lbs.

Scale is accurate to 1/10 of 1%. The scale also comes with a display powered by 4 AA batteries and 20' cables, marked for the correct pad. Durable carrying case also included. Batteries included.

### New Features

- Cross weight percentages
- Side/Side percentages
- Front/Rear percentages

67650 .....5000 lb. Vehicle Weighing Scale

**New Wheeled Hard Case with Telescoping Handle!**



## NEW! 7000 lb. Wireless Vehicle Weighing System

PROFORM's next generation slim wireless vehicle scale includes NEW features! Features such as, full size 15" x 15" slim aluminum scale pads (1 5/16" thick), drive-up angle for easy setup, live stream data feed via USB cable (included) to computer with free downloadable program for viewing and file exporting, backlit LCD screen and control buttons, and a foam lined hard case with wheels for storage. Standard features include an LCD display with Cross weight, Side/Side weight, and Front/Rear weight in addition to the standard weight and percentage for each wheel and total vehicle weight. The individual scale pads have a 1,750 lb. capacity per pad for a total scale capacity of 7,000 lbs. Scale is accurate to 1/10 of 1%. Scale pads are made of die-cast aluminum, and finished in a durable black powder coat. AA batteries included.

### New Features

- Super Slim 15"x15" Aluminum Weighing Pads
- Drive-up Angled Edges on Pads
- Backlit LCD Screen
- Wheeled Hard Storage Case with Telescoping Handle
- Free downloadable PC program that displays LCD content via USB cord

67644.....7000 lb. Wireless Vehicle Scale System

**New Wheeled Hard Case with Telescoping Handle!**



## NEW! 400 lb. Gas Can Weighing System

Don't be that guy that runs out of gas on the last lap and goes from greatness to pushing their car across the line. Most race cars don't have fuel gauges, so gas quantity, weight, and consumption leads to a carefully managed mathematical equation that can pay off big time in the end e.g. see Alexander Rossi's 2016 Indianapolis 500 finish if you have doubts about how fuel management can be a strategy for victory. Part of that winning strategy starts with a gas can scale and knowing how much gas is going into the vehicle. Proform's NEW gas can scale has a 400 lb capacity, with a resolution of 0.1 lbs. The system is comprised of a single wired scale pad from PROFORM's reliable 5000 lb wired vehicle scale that has been redesigned for reduced capacity, and increased accuracy. The gas can scale system also features the new 3rd generation LCD display with backlit screen for night and day use. There's more...the system comes in a hard shell carrying case. AA batteries included.

### New Features

- 400 lb Capacity,
- Resolution of 0.1 lbs.
- Single wired scale pad
- Redesigned for reduced capacity, reliability and increased accuracy
- New 3rd generation Backlit LCD display screen for night and day use
- Hard shell carrying case

67646.....400 lb. Gas Can Weighing System



Now Available!

# GET YOUR VEHICLE READY FOR THE BIG RACE, WITH PROFORM!

**NEXT GENERATION  
WIRELESS 7000 LBS. VEHICLE SCALE**

**INTRODUCING  
GAS CAN WEIGHING SYSTEM**



Part #67644



Part #67646

**NEW FEATURES:**

- NEW! Ultra-Portable Hard Storage Case
- Super Slim 15"x15" Aluminum Weighing Pads
- New, 3rd Generation LCD Backlit Display



**NEW FEATURES:**

- Single Wired Scale Pad Optimized for Increased Accuracy
- New, 3rd Generation LCD Backlit Display
- Ultra-Portable Hard Storage Case





# PISTON INSTALLATION TOOLS

## Electric Piston Ring Filer

Accurately set end gap with PROFORM's powerful electric ring filing tool. Powered by a 12 volt, rechargeable battery. Offers maximum speed and affordability. Comes with two (2) 120-grit grinding wheels (p/n 66762) and battery recharger. Portable or can be bench mounted.

- 66765 ..... Piston Ring Filer, Electric
- 66762 ..... Grinding Wheel for Electric P/N 66765



## Manual Piston Ring Filer

To assure proper piston ring end-gap, the piston ring filer enables the user to file piston rings quickly and accurately including LS1 engines. Position the piston ring firmly against the dowel pins, crank the handle to turn the abrasive wheel. Using a feeler gauge, file the piston ring to meet the manufacturer's specification.

- 66785 ..... Ring Filer, Manual

### Replacement 120-grit Grinding Wheel

Optimize the performance of Piston Ring Filer P/N 66785 with this replacement grinding wheel.

- 66786 ..... Grinding Wheel for Manual P/N 66785



## Professional Piston Ring Friction Pull Measurement Tool

All the top race crews know that minimizing piston ring friction to the lowest amount before blow by is one of the best ways to maximize engine efficiency. This tool accurately measures the pull of a ring in the bore. This is the ultimate tool for quantitatively measuring friction as a function of gap and diameter. Get it right, and get the trophy! The kit includes two expandable platforms for pulling, and a precision digital gauge for accurate readings. Tool fits ring bore diameters between 2.377"-6.25". Detailed instructions included. U.S. Pat. 8,479,570

- NEW!** 67657... Professional Piston Ring Friction Pull Measurement Tool.



**NEW!**

## Billet Aluminum Piston Ring Squaring Tool

Square up your rings perfectly every time with these handy billet aluminum piston ring installation tools.

- 67656 ..... 4.000" - 4.230"
- 67654 ..... 4.240" - 4.380"
- 67653 ..... 4.400" - 4.640"



## Heavy-Duty Multiple Angle Piston Vise

Finally an affordable piston vise with all the best features including; quick set-up, repeatability, billet aluminum, corrosion-resistant anodizing, universal, and easy to use. Up to 4.5" diameter pistons.

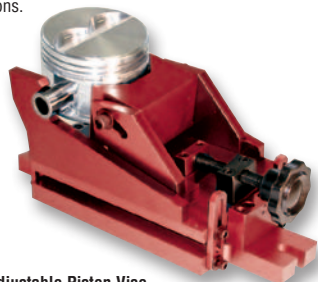

66772 ..... Heavy-Duty Adjustable Piston Vise

## Piston Dome Thickness Checker

Who would dare to modify piston domes or to fly-cut valve pockets without knowing how much material there is to work with? This simple tool includes a 0.001" dial indicator and a contact point that permits measurement of the most complex dome shapes. An essential tool for every well-equipped machine shop.



66833 ..... Piston Dome Thickness Checker

## Universal Piston Ring Installer

Easily install piston rings with PROFORM's new universal piston right compressor/installer. Kit includes one adjustable clamp that fits 3 7/8 to 4 3/8 bore sizes and one ring compressor. Just slide the clamp over the piston, tighten down to size, and tap into bore. It's that easy!



67725 ..... Universal Piston Ring Installer

## Heavy-Duty Piston Installation Tool

The PROFORM piston installation tool features nylon-composite construction so you can knock away all night without any damage to your expensive pistons! This affordable tool weighs just under 2 pounds, features steel-shot filled chamber, and an easy-grip handle.



67571 ..... Piston Installation Tool

## Adjustable Ring Compressor

Putting the connecting rod through first, simply place the piston (with rings) into the tapered end of the ring compressor. Tighten the compressor snugly around the base of the piston. Then lay the compressor flat on the engine cylinder bore.



- 66766 ..... 4.000" - 4.090" Blue
- 66767 ..... 4.125" - 4.205" Gold
- 66768 ..... 4.205" - 4.310" Red

## Universal Piston Ring Squaring Tool

Get your piston rings aligned the first time! Just simply press piston rings down for perfect depth every time. U.S. Pat. 6,421,930



67652 ..... Piston Ring Squaring Tool

## Universal Ring Installation Tool

This stainless steel tool makes installing pistons easy. Putting the connecting rod through first, simply place the piston (with rings) into the tapered end of the ring compressor. Tighten the compressor snugly around the base of the piston. Then lay the compressor flat on the engine cylinder bore. U.S. Pat. 6,427,301



67655 ..... Universal Ring Installation Tool

## Tapered Ring Compressors

The PROFORM tapered ring compressor is an affordable and easy way to install your pistons! By creating a slight squeeze on the piston ring the compressor eases the piston into the cylinder bore. Manufactured for engine blocks with studs.



- 67445 ..... Tapered Ring Compressor 4.030 (shown above)
- 67448 ..... Tapered Ring Compressor 4.000
- 67449 ..... Tapered Ring Compressor 4.040
- 67450 ..... Tapered Ring Compressor 4.060
- 67451 ..... Tapered Ring Compressor 4.125
- 67452 ..... Tapered Ring Compressor 4.155
- 67572 ..... Tapered Ring Compressor 4.250
- 67573 ..... Tapered Ring Compressor 4.280
- 67574 ..... Tapered Ring Compressor 4.310



## VALVE SPRING TOOLS

### Mini Valve Spring Tester and Measuring Combo

With this all-in-one tool, you'll no longer need to use a ruler or micrometer to measure spring height. Simply set the spring height with the highly refined measurement tube (0.01" increments), put it in the vise and start testing. The digital gauge includes peak hold, and backlighting feature. Max spring diameter is 1.7".

- 66841.....0-600lb x 10lb Spring Tester Combo  
 66842.....0-700lb x 2lb Digital Spring Tester Combo



### Mini Valve Spring Testers

Here's the affordable, portable way to test springs. The hex-design body is very versatile: use it in a vise or an arbor press. The digital gauge includes 2 lb increments with peak hold, and backlighting features. Digital gauge swivels 90° for easy viewing.

- 66835.....0-300 x 5lb Spring Tester  
 66834 (Shown A).....0-700 x 10lb Spring Tester  
 66837 (Shown B).....0-1000 x 20lb Spring Tester  
 66836 (Shown C).....0-700 x 2lb Digital Spring Tester



### 1000 lb. Digital Spring Tester

PROFORM's new billet aluminum 1000 lb. digital bench top spring tester is the most accurate way to check spring pressure. Check springs up to 1.5" in diameter and 4" in height. Digital display reads in 1 lb (0.5 kg) increments, and has a backlighting feature. Peak hold and automatic shutoff are other included features.

- D. 66776.....1000 lbs. Digital Spring Tester

### Pneumatic Valve Spring Compressor

Cut cylinder head assembly and disassembly time in half with the Proform pneumatic valve spring compressor. Builds 350 lbs. of force with 125 psi, and will operate on a minimum of 100 psi. The compressor arm slides for adjustment, employing a locking pin for rapid, easy installation. Works on most cylinder heads.

- E. 66849.....Pneumatic Valve Spring Compressor

### Professional Heavy-Duty Spring Compressor

Compress even the largest valve springs with this adjustable professional spring compressor that is loaded with new features: reinforced compression-hold handle, reinforced adjustable arm with dual locking pins, and aluminum spring cup inserts for better alignment. This is designed for the professional cylinder head expert, so compressing and removing valve springs is quick and easy!

- NEW!** 66764.....Professional Heavy-Duty Spring Compressor

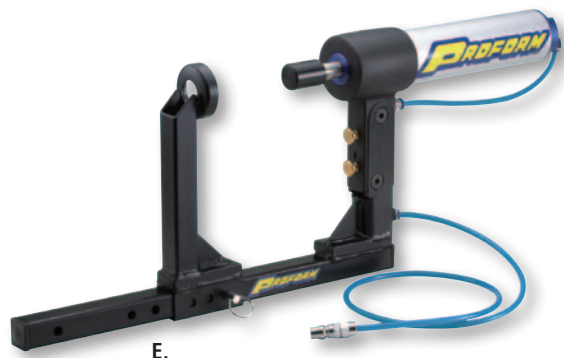

## Adjustable Digital Valve Spring Pressure Tester

PROFORM's new on-head valve spring tester features a digital gauge and an adjustable base to fit all common aluminum rocker lengths and offsets. The digital gauge includes 5 lb increments with peak hold and backlighting features. The housing is made of black anodized billet aluminum with a knurled grip area for ease of use. Capacity range from 0-600 lbs.



67601 ..... Digital Valve Spring Tester

## Valve Spring Pressure Tester

Need to check spring pressure at the track? No problem with the PROFORM stud style valve spring compressor. This fully adjustable tool fits easily onto your rocker arm for pressure checks and will measure pressure up to 600 lbs.



67597 ..... Valve Spring Pressure Tester

## Heavy-Duty Valve Spring Tester

Accurately check spring height versus spring pressure with our new heavy-duty bench top spring tester. Check springs up to 2" in diameter and 4" in height. Separate part numbers for up to 300 lbs and 700 lbs spring pressures. Can be bench or vise mounted.



66774 ..... Spring Tester, 300 lbs spring pressure  
66775 ..... Spring Tester, 700 lbs spring pressure

## Heavy-Duty Valve Spring Compressor

This heavy-duty, simple-to-use, manual valve spring compressor makes short work of even monstrous springs. The compressor arm slides for adjustment, employing a locking pin for rapid, easy operation.



66832 ..... Valve Spring Compressor

## LS Valve Spring Compressor Tools

Easily compress two springs at a time with just a few turns of the wrench. Mounts directly to GM LS heads. Fits LS1/LS6.



67605 ..... LS1/LS6 Spring Compressor



**NEW!** 67603 ..... Universal LS Spring Compressor

## Stud Mount Valve Spring Compressor

For all 3/8" and 7/16" Rocker Studs. Remove valve spring from an assembled engine for checking or replacing quickly and easily. Press down to compress coil spring, then remove valve keepers. Release slowly.



66784 ..... Spring Compressor

## Valve Check Spring

These light-pressure springs make the assembly of components much easier. They provide enough pressure to hold the valve assembly together when checking camshaft figures, installed height, etc. 2 Pcs.



66793 ..... Spring



# HARMONIC BALANCERS, CRANKSHAFT TOOLS

## Harmonic Balancer Installer/Puller

Works with all Ford, GM, and Chrysler engines. This heavy-duty, professional tool, equipped with roller thrust bearings, can also be used as a universal puller! In addition to the 3/4 x 16 shaft, the kit includes 7/16 x 20, 5/8 x 18, 1/2 x 20 adapters, and various removal hardware. May also be used for steering wheel and pulley installation and removal. Maximum recommended torque is 150 ft. lbs.

66514 ..... Installer/Puller



## NEW! Universal Harmonic Balancer Installer Tool Kit

One tool set to install just about any balancer out there. With 12 adapters to fit a variety of applications, this one-stop shop kit will allow a builder to keep everything together in a neat and organized way. Roller thrust bearing included to reduce friction. Case included.

NEW! 66520.....Universal Harmonic Balancer Installer Kit



## Harmonic Balancer Installation Tools

This tool makes installing the harmonic balancer simple; just thread the proper end into the crankshaft, and then rotate the nut which presses the bearing against the balancer which will slide onto the crankshaft smoothly.

66515 ..... Chevy S/B and B/B Installation Tool  
66519.....GM LS Installation Tool

NEW!



### Dial Indicator Magnetic Base

Engine building work requires a dial indicator, but precise engine building work demands a dial indicator magnetic base. This PROFORM tool will hold your dial indicator in nearly any position. The magnetic base has 100 lbs of pull and comes with an easy on/off switch for portability.



67425 ..... Dial Indicator Magnetic Base

### Top Dead Center Locator

This tool provides a positive stop for the piston when locating top dead center. It screws into the spark plug hole.



66792 ..... Chevy TDC Locator  
67581 ..... Chrysler TDC Locator

### Crankshaft Turning Nuts

These heavy-duty PROFORM Crankshaft Turning Nuts are a MUST HAVE for the engine builders' tool box. Rotating the crankshaft during assembly is now an easy task with these steel crankshaft nuts for Chevy SB, BB, and Chrysler V8s.



67439 ..... Chevy BB Crankshaft Turning Nut  
67440 ..... Chevy SB & V6 Crankshaft Turning Nut  
67441 ..... Ford SB, Pontiac, and Buick  
67442 ..... Chrysler V8 Crankshaft Turning Nut

### Chevy B/B Oil Pump Pick-Up Driver Tool

No more banged up oil pickups and punctured tubes. Easily installs oil pickup tube. For Chevy big block engines.



66480 ..... Chevy B/B Oil Pump Pick-Up Driver Tool

### Top Dead Center Locator

Easily checks top dead center by bolting down across cylinder bore. (Used w/ heads off)



66799 ..... Top Dead Center Locator

### Crank Shaft Turning Socket

Engine work requires repeated crankshaft rotation. This non-marring, aluminum tool rotates the crankshaft the proper way, when the balancer is off. Making sure to have the proper size, position this socket over the end of the crankshaft, so it can be turned using a 1/2" breaker bar or drive ratchet.



66899 ..... Chevy B/B (1.610" ID with 3/16" keyway)  
66900 ..... Ford S/B, Buick, and Pontiac (1.385" ID with 3/16" and 1/4" keyways)  
66901 ..... Chevy S/B & I V6 and GM 4-cylinder engines (1.255" ID with 3/16" keyway)

### Pipe Plug Removal Tool

Easily remove male and female plugs with PROFORM's new pipe plug removal tool. 1/2" drive impact socket with retractable 1/4" steel bit.



67447 ..... Pipe Plug Removal Tool, 1/4"

### Spark Plug Hole Thread Chaser

Avoid stripped spark plug holes with our affordable spark plug hole thread chaser. Double ended to fit 14mm and 18mm threads.



66821 ..... Spark Plug Hole Thread Chaser

### Engine Rotation Adapter

For Chevy or Ford V8 engines. Easily attaches to the balancer. Useful when assembling an engine or degreasing the cam. Then the crankshaft can be rotated with a 1/2" breaker bar or a 1" socket and breaker bar.



66782 ..... Rotation Adapter

### Crank Gear Installation Tool

This heavy-duty crank gear installation tool makes it easy to press gears on straight. Use this tool with PROFORM's harmonic balancer installer set, p/n 66514.

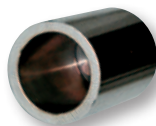

67453 ..... Crank Gear Installation Tool

### Professional Crankshaft Turning Sockets

Professional grade crankshaft socket with degree wheel attachment.



67491 ..... Chevy S/B  
67492 ..... Chevy B/B  
67493 ..... Chrysler V-8  
67606 ..... Chevy LS1/LS6 "Gen III"



# CAMSHAFT TOOLS

For use with heads off LS engines. This kit contains all the tools needed to degree cams in the most popular engines, assuring proper cam timing and lobe lift. Features deluxe components including 9" degree wheel, dial indicator, adjustable blue billet aluminum dial indicator mount, black billet aluminum top dead center locator, wire degree wheel pointer, professional stainless steel crankshaft turning socket, detailed instructions, and a durable foam padded carrying case.

**A. 68786.....Heads Off Degree Wheel Kit for GM LS**



A.

## Universal Degree Wheel Kits

These kits contain all the tools needed to degree cams in the most popular engines, assuring proper cam timing and lobe lift. Features deluxe components including 9" degree wheel, dial indicator mount/clamp kit (66787 only), 2 valve check springs (66787 only), billet cam checking fixture (68787 only), top dead center locator, wire degree wheel pointer, detailed instructions, and a durable foam padded carrying case.

**B. 66787.....Heads On Degree Wheel Kit**

**C. 68787.....Heads Off Degree Wheel Kit**



B.



C.

## Universal Cam Checker Tool

This easy-to-use tool simply slides down into the lifter bore and is adjusted until expanded securely. Supplied with two followers: one for flat tappet cams and one for roller cams.



**68902...Universal Cam Checker Tool .750 to 1.050**

## Cam Checking Fixture (with Heads On)

No more fumbling with a magnetic base and a dial indicator to measure cam lift. This fixture attaches to a 1/4"-20" valve cover bolt hole and holds the dial indicator in the precisely correct position over the rocker arm or valve retainer, assuring proper geometry. Includes 0-1.000" Dial Indicator 66962 (0.001")!



**66829.....Cam Checking Fixture (Heads On)**

## Cam Checking Fixture (with Heads Off)

Includes 0-1.000" Dial Indicator 66962 (0.001"! No more fumbling with a magnetic base and a dial indicator to measure cam lift. This fixture maintains and holds the dial indicator and 5" extension (included) in the precisely correct position over the lifters, assuring proper geometry. Supplied with 1/2" and 7/16" adapters for use with any engine block.



66830 ..... Cam Checking Fixture

## Cam Checker Tool

Includes 0-1.000" Dial Indicator 66962 (0.001"! With O-rings on each end to assure securing positioning, this unit slides down into the lifter bore and sits atop the camshaft for accurate measurement of lobe lift and base circle runout. Supplied with two followers, one for flat tappet or hydraulic cams, and the other for roller cams. Designed for GM (.842" dia.) and Ford (.875" dia.) applications.



66838 ..... GM/Ford Cam Checker Tool

## Camshaft Installation Handles

This easy-to-use universal camshaft installation tool comes with five adaptors for most domestic V-6 and V-8 engines including LS1 engines. The heavy-duty easy-grip handle keeps the job comfortable and provides plenty of support.



66898 ..... Universal Camshaft Installation Handle

**For Chevy V6 and V8 engines** (except hydraulic roller camshafts). Providing a solid grip, this hex design handle makes it easy to install or remove your camshaft. Installation bolts included in handle.

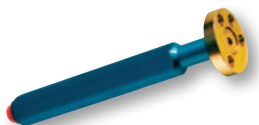

66897 ..... Camshaft Tool

## Cam Bearing Installation Tool

For Chevy small block engines. This kit contains everything a professional needs to remove old cam bearings and to install new ones. This task is easily accomplished by following our step-by-step instructions. Contains an arbor with drive mount, 2 drive spools, 2 spool stabilizers, and a drive cap.

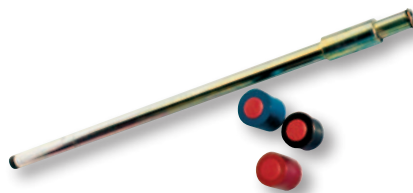

66794 ..... Cam Tool

## Degree Wheel, 9"

Use this Degree Wheel to find top dead center or for checking camshaft timing. Follow our detailed step-by-step instructions, included with each Degree Wheel.



66791 ..... Degree Wheel

## Professional 16" Billet Aluminum Degree Wheel

Oversized wheel with large numbers makes reading this billet aluminum degree wheel easy!

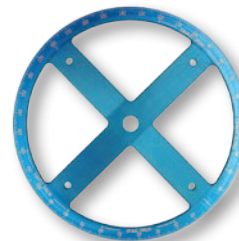

67490 ..... 16" degree wheel

## Universal Cam Bearing Driver Kit

Drive camshaft bearings easily with one complete, universal kit. Now you can remove or insert camshaft bearings in nearly all engines from sport compacts and muscle cars to heavy-duty trucks. The expander arm has a neoprene sleeve with the split driving plugs mounted and expanded to size. Kit comes with two sets of rubber sleeves for each expanding driver. Use the brown sleeves for thin wall bearings and the black sleeves for thick wall bearings. Range 1.25" to 2.69" (28.58 - 68.3mm). Includes: Driving shaft, driving shaft extension, expander unit, five (5) split driving plugs, two driving collars, centering cone and handy carrying case.



66820 ..... Universal Cam Bearing Driver Kit



## CYLINDER HEAD TOOLS

### Valve Lash Wrench Set

T-Handles. This simple T-handle and wrench set makes adjustment very easy, cutting the adjusting time in half. Simply position the adjusting handle wrench over the rocker arm lockdown (make sure you have purchased the set with the proper sized wrench), and drop the appropriate T-handle down through the hole in the wrench - with one hand doing the job of two! Then make the lash adjustment with a feeler gauge according to the camshaft manufacturer's specifications.

- 66778 ..... 1/2" with 3/16" and 1/8"
- 66779 ..... 7/16" with 1/8"
- 66780 ..... 9/16" with 3/16" and 7/32"
- 66781 ..... 5/8" with 3/16" and 7/32"



### Cylinder Head Work Stand Adjustable

Our heavy-duty cylinder head work stand is great way to hold your cylinder heads above your workbench while working on them. The adjustable arms allow you to set the proper height and maintain stability.

- 66483.....Cylinder Head Work Stand, Adjustable

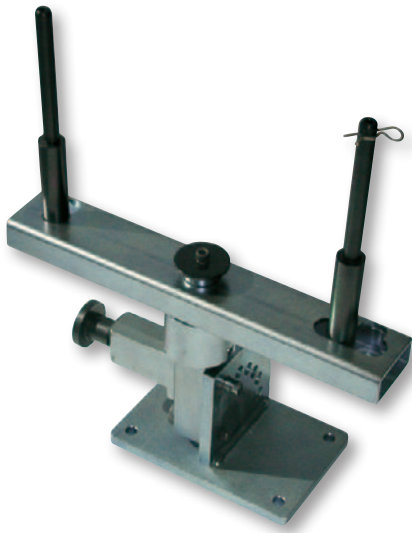

### Magnetic Deck Bridge

This will go over cylinder bores up to 4-1/2". This is used to check piston-to-deck clearance, and it is magnetic so it holds firmly in place. Dial Indicator 66962 is sold separately.

- 66797 ..... Magnetic Deck Bridge



### Tall Valve Spring Height Micrometer (0.001")

Measure installed valve spring height conveniently and accurately. Simply install the height micrometer instead of a valve spring, and then rotate the clearly engraved dial to expand the tool to seat the valve, locks and retainers.

- 66902.....Range: 1.600" - 2.100" (for most V8 engines)
- 66903.....Range: 1.400" - 1.800" (for most 4 and 6 cylinder engines)
- 67390.....Tall Hite Mike for Beehive Valve Springs

## Deck Bridge without Magnetic Base

This will go over cylinder bores up to 4-1/2". This is used to check piston-to-deck clearance. Does not have a magnetic base. Dial Indicator 66962 is sold separately.



66798 ..... Deck Bridge w/o Magnetic Base

## Stud Extracting Tool

Easily allows removal of stubborn studs, such as rocker or cylinder head studs.



66796 ..... Stud Extracting Tool

## Cylinder Head Handles

This pair of heavy-duty cylinder head handles is made from durable aluminum and allows you to easily move the heads around the shop. Mounts to rocker stud holes.



67429 ..... Cylinder Head Handles

## Rocker Stud Remover and Tap Alignment Kit

For Chevy V8 and V6 engines. Before installing the heavy-duty screw-in studs required for high-performance valve train components, this tool conveniently removes the factory pressed-in rocker studs.



66783 ..... Stud Remover

## NEW! Stud Boss Cutter Tool

Make quick work of those factory head bosses with this cutting tool. Includes guide tip that fits into the stud hole.



NEW! 67568 ..... Stud Boss Cutter

## Valve Seal Installer

Another gouged PC seal? No longer will you have worry about gouging and twisting your seals with the PROFORM valve seal installer. Works with .500" and .531 PC seals and comes with handy knurled end for better grip.



66444 ..... Valve Seal Installer

## Dual-Gauge Leakdown Tester

This dual-gauge leakdown tester measures the condition of your head gaskets, piston rings, and valves. The gauge records incoming air pressure, and the right gauge records individual cylinder pressure - and the difference is your leakdown.

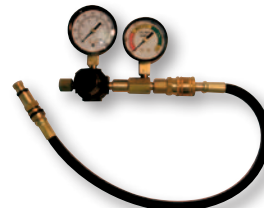

66839 ..... Dual-Gauge Leakdown Tester

## Cylinder Head CC Kit

This is the kit you need to accurately cc most cylinder head combustion chambers. Includes a precision glass 100 cc burette with easy-to-read 0.2cc division lines, an integral petcock for precise measurement and easy flow-control, a burette clamp, a stand with a firm base, a flat acrylic plate to cover the combustion chamber.



66831 ..... Cyl. Head CC Kit (100x.2cc)

## Heavy-Duty Aluminum Head Holders, V-Style

Modify and maintain your cylinder heads with ease with the heavy-duty aluminum head holders. Sold in pairs.



66481 ..... Heavy-Duty Aluminum Head Holders, V-Style

## Pushrod Slotting Tool, Chevy S/B

Easily modify your heads for 1.6 ratio rockers with this handy pushrod slotting tool. Simply use a 5/16" drill bit to correctly lengthen the pushrod slot with precision. Recommended usage is one tool for each set of heads.



66485 ..... Pushrod Slotting Tool, Chevy S/B



## ENGINE BLOCK TOOLS

### Chevy Oil Pump Primer with Bushing

For Chevy V8 and V6 90° engines. This Oil Pump Primer offers a superior design: it includes a bushing to pressurize the valve train, and it primes the oil pump directly through the distributor hole, using a 3/8" drill.



66896.....Chevy Oil Pump Primer

### NEW! Chrysler Distributor Bushing Installer and Reamer Tool

This important tool makes installing the lower distributor drive shaft bushing into the engine block and subsequent reaming a snap. Simply tighten down to install the bushing, and spin the tool on the way out for a clean ream. This prepares the bushing properly prior to distributor installation..



66488..... Chrysler Distributor Bushing Installer and Reamer Tool

### NEW! Ford Oil Pump Primers

Easily prime your Ford engine right through the distributor hole by simply using a power drill.



NEW! 67566.....260-302, 1/4" Hex  
NEW! 67567.....351W, 400-460 5/16" Hex

### Block and Head Handles

This complete set of four heavy-duty block and head handles is made from durable aluminum and allows you to easily move that engine around the shop. Will fit in most cylinder heads and blocks with 3/8" holes.



67446.....Block and Head Handles

### NEW! LS Engine Lift Plate for 2006-16 Gen IV engines

Proform's steel, multiple attachment point, LS Engine Plate makes out getting the engine out and in a cinch. Simply remove the intake manifold and valley tray cover, then replace it with this robust lift plate using the existing valley tray bolts. It also acts as a valley cover for storage purposes. Give your engine some tilt for ease of use.



NEW! 67459....LS Engine Lift for '06-'16 engines.

### Engine Lift Plate

PROFORM's new steel lift plate fits most engines with Holley® 2 barrel and 4 barrels as well as the Dominator.

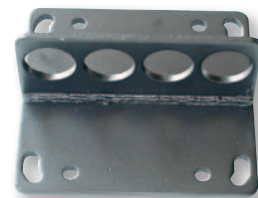

67457...Engine lift Plate

## CONNECTING ROD TOOLS

### Connecting Rod Vise

Holding connecting rods securely without damaging them is necessary for removing or installing rodbolts, beam polishing or machining. This aluminum vise is designed for all sizes of aluminum or steel rods, and can hold several at once. It will mount in a bench vise or can be permanently mounted.

66769 ..... Connecting Rod Vise



### Rod Bolt Stretch Gauge

0.001 Dial indicator. Check rod bolts the proper way, because sometimes torque readings may vary. Using the stretch factors supplied by rod bolt manufacturers, this stretch gauge offers a highly accurate way to measure torque pre-load. With a special, high-tension spring, this gauge remains conveniently positioned on the bolt during tightening, with adjustability for bolts up to 2.75" long. Simply position the stretch gauge over the length of the rod bolt before applying torque, take a reading, and record it. Then torque down to the proper torque setting, and take another reading with the stretch gauge. Calculate the difference and check the manufacturer's specification.

66788 ..... Stretch Gauge



### Heavy-Duty Rod Splitting Fixture

Let's face it, connecting rods rarely come apart easily. That is until now. Quickly separate the cap from the rod without damage using PROFORM's new Heavy-Duty Rod Splitting Tool. Simply loosen the rod nuts a couple of turns, place the rod onto the splitting fixture, and pull the handle. Portable, for use with your bench top vise.

66773 ..... Rod Splitting Fixture



### Connecting Rod Balancer

This fixture holds each end of the connecting rod on the scale sold separately, for weighing the big and small ends. It comes with two mandrels to cover most popular engines, and it is ordinarily used with a digital or mechanical weighing scale. Digital scale (66466), and connecting rod not included.

66844 ..... Rod Balancer

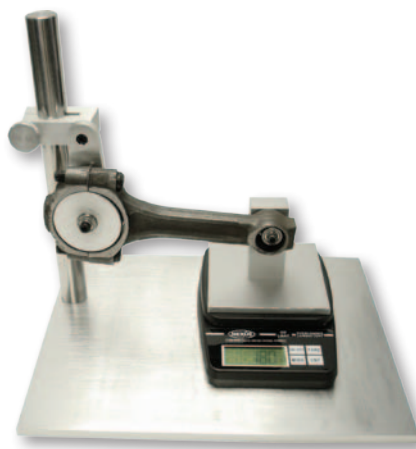

### Connecting Rod Balancer Chevy SB

Here's the quick and dirty way to match weigh your small block Chevy connecting rods! Simply put two connecting rods on the roller, even them out, and set the roller on the base. You'll quickly determine if your rods are balanced, and if not, which one is heavier.

67596 ..... Connecting Rod Balancer for Chevy Small Block

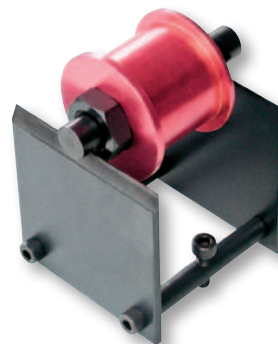

### Handheld Rod Splitting Tool

Easily separate your connecting rod caps with this non-marring hand-held splitter. Just turn the handle and the unit opens up so the 4 non-marring ends push the cap apart. U.S. Pat. 7,155,791

67905.....Handheld Rod Splitting Tool





## MISC. ENGINE BUILDERS TOOLS

### Adjustable Aluminum AN Wrenches

PROFORM's new aluminum adjustable wrenches are a perfect fit for any under hood plumbing project. They are especially useful when trying to prevent scratching expensive hose fittings, fuel log adjustment, and tightening fuel inlet fittings. Key features include adjustable, non-marring, and anodized for durability. Durable, theft-resistant clamshell packaging. These handy wrenches are available individually or together at a discounted price.

- 67727 ..... 3AN-8AN adjustable wrench
- 67728 ..... 10AN-20AN adjustable wrench
- 67729 ..... Wrench set that includes 67727 & 67728

### Stubby Adjustable A N Wrenches

- 67722 ..... Stubby wrench set that includes  
67723 & 67724
- 67723 ..... Stubby 3AN-8AN adjustable wrench
- 67724 ..... Stubby 10AN-20AN adjustable wrench

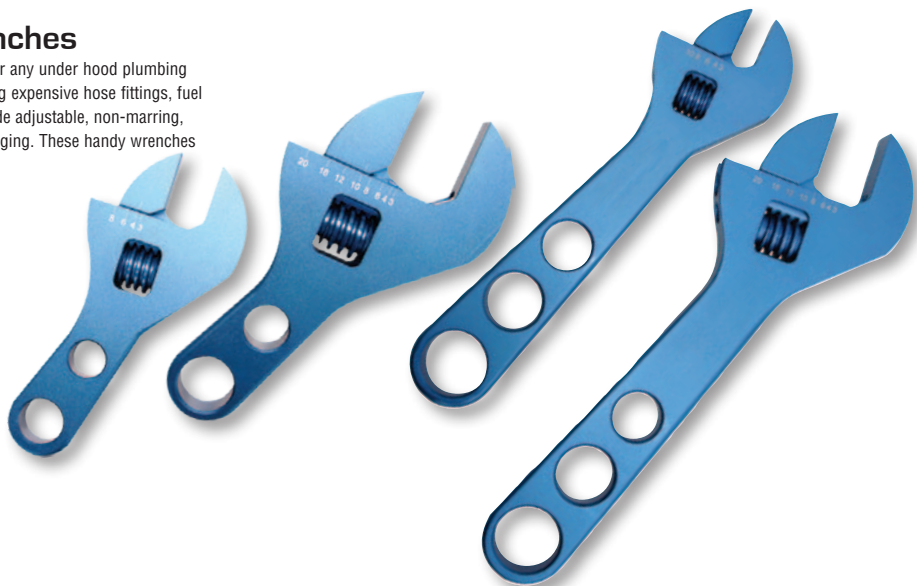

### Digital Tire Pressure Gauge

Don't let a little tire pressure change affect you on race day! Quickly and easily gauge tire pressure with PROFORM's easy-to-use, hose equipped digital tire pressure gauge. Backlit digital display reads in Psi, Kpa, Bars, and Kg/cm<sup>2</sup>. 0-60 psi in 0.1 psi increments. Backlit screen stays lit for approx. 30 seconds upon turning on. Automatically shuts off after a few minutes of inactivity. Air bleed valve included. Includes rubber gauge protector.

- 67395 ..... Digital Tire Pressure Gauge 0-60 psi



### Pinion Setting Tool

For rear ends. Universal pinion setting tool so you can measure pinion depth of most automobiles and trucks.

- 66516 ..... Pinion Setting Tool



## A N Hex Wrenches

Affordable A N Hex Wrenches. Color coded for fast identification, these PROFORM<sup>®</sup> wrenches offer resistance to scratching hose fittings as they are being tightened and loosened.



- 66970C ..... Alum Hex Wrench #3 1/2"
- 66971C ..... Alum Hex Wrench #4 9/16"
- 66972C ..... Alum Hex Wrench #6 11/16"
- 66973C ..... Alum Hex Wrench #8 13/16"
- 66974C ..... Alum Hex Wrench #10 1"
- 66975C ..... Alum Hex Wrench #12 1-1/4"
- 66976C ..... Alum Hex Wrench #16 1-1/2"
- 66977C ..... Alum Hex Wrench #20 1-3/16"
- 66978 ..... Full Set in Fold-Over Pouch

## Tubing and Pipe Notcher Tool

Designed for the serious fabricator. 0 to 45 degree, 1 degree increments, adjustable vise and made of high-grade aluminum.



66482 ..... Tubing and Pipe Notcher Tool

## Universal Oil Filter Cutter

Troubleshooting your oil management system requires a look at the filter. That's now easier than before with the PROFORM oil filter cutter. Think of a simple can opener and you've got the concept behind this trick tool. Lock-down holds your cartridge filter in place while you rotate the filter to make a clean cut.

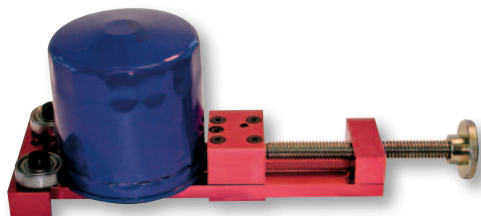

66490 ..... Universal Oil Filter Cutter

## Digital Tire Pressure Gauge

Take the guesswork out of tire pressure measurement! Digital display includes a PEAK hold function, and backlighting. Also includes bleed buttons for tire bleeding, and a peak hold hose pressure bleed. 0-100 psi in 0.01 psi increments.



67399 ..... Digital Tire Pressure Gauge 0-100 psi.

## Universal Dial Indicator

Universal Dial Indicator, graduation: 0.001.



66962 ..... Range 0 to 1.000"

66963 ..... Range 0 to 0.250"

## NEW! Freeze Plug Installer Set

Constructed of high density nylon for strength and durability, but yet won't mar the freeze plugs themselves during installation. The kit includes three 6" installers for popular size freeze plugs: 1 1/2" shallow, 1 5/8" deep, and 1 3/4" shallow.



NEW! 67565 ..... 3 Piece Freeze Plug Installer Set

## Air Hold Adapter Set

Now that you have the PROFORM Valve Spring Tester you'll need a set of PROFORM Air Hold Adapters to remove your springs with the heads on the engine. It's a simple 3-step process: screw the air hold adapter into your spark plug hole, attach air fitting, and then an air hose. The air pressure will hold up your valves while you get to work!



67400 ..... Air Hold Adapter Set

## Professional Rocker Arm Stud Remover

Make stud removal easier with our professional rocker arm stud remover tool. With ball bearing action and fittings for 5/16" and 3/8", this tool is a must have for all engine builders.



66484 ..... Professional Rocker Arm Stud Remover



## PATENTED SHOP TOOLS

### PROFORM® Patented No-Mess™ Funnel

The PROFORM No-Mess Funnel allows you to fill anything without worrying about overspills. The patented ball-n-hook design shuts off flow and retains the excess fluid when lifted. U.S. Patent No. 5,950,697 & 6,341,631. Award winning funnel POP display available.

- 68068.....PROFORM® Patented No-Mess™ Funnel
- 68069.....No-Mess Funnel in-store merchandiser with 100 funnels, Dimensions: 21" x 21" x 39
- 68071.....No-Mess Funnel hanging clipstrip with 12 funnels
- 68072.....No-Mess Funnel 12 Pack, 11 funnels + 1 funnel Free, Refill for 68071



### PROFORM® Socket Assist

Essential tool for bolts with tight clearance like spark plugs and header bolts! 12-point for maximum finger traction. Set of three including 1/4" x 1/4", 1/4" x 3/8", 3/8" x 3/8" (12 pt x socket size). Belongs in every tool box! U.S. Pat. 6,019,019.

- 67575.....Socket Assist, single set
- 67576.....Socket Assist, P.O.P clipstrip of six (6)



### PROFORM® Patented No-Mess™ Oil Pan Drain Plug

The PROFORM engine oil drain plug has a unique, patented, rubber extension which acts as a sealing "cork" when changing engine oil. As the drain plug is unscrewed and loosened, the "cork" seals the threaded drainhole, reducing mess and contact with hot oil. A firm tug releases the oil when desired. This plug minimizes the chance of a plug being dropped. U.S. Patent No. 5,547,042.

- 66960.....Oil Drain Plug, 1/2"-20



## CARB TOOLS

### Carb Float Adjustment Tool

No more sleight-of-hand tricks! Easily adjust your carburetor float level with this hand float adjustment tool. 5/8" socket and built-in screwdriver blade protects your engine and hands from fuel spray.

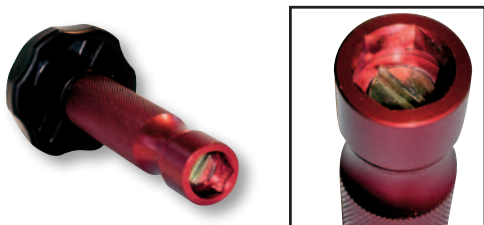

67443.....Carb Float Adjustment Tool

### Aluminum Power Valve Remover Tool

Never damage your metering blocks again! PROFORM's new aluminum power valve remover tool makes power valve removal a snap. Simply place the tool over the power valve and give it an easy turn.



67454.....Aluminum Power Valve Remover Tool

### Jet Installation Tool

Don't damage your jets with a clumsy screwdriver. This handy tool makes installation and removal of jets a cinch.



67469.....Jet Installation Tool

## PUSH ROD TOOLS

### Push Rod Length Checker

For Chevy small block and big block engines. Proper push rod length is absolutely critical for peak performance – minimizing bent or broken valve stems, guide wear, and energy-wasting valve side-loading friction.



66789 .....3/8" studs, small block  
66790 .....7/16" studs, small block  
66806 .....7/16" studs, big block

### Adjustable Pushrod Length Checker

Measure the proper pushrod length with these simple length checkers. Don't chance destroying your valvetrain because of improper pushrod geometry!



67560.....Length checker, 6.125 – 7.500  
67561.....Length checker, 7.500 – 8.700  
67562.....Length checker, 8.500 – 9.800  
67563.....Length checker, 9.700 – 11.00  
67564.....Length checker, 10.200 – 11.500

### Universal Push Rod Straightness Checker

Easily check concentricity to discard any power-robbing, bent push rods; insert pushrod between spring-loaded holders, spin the pushrod, and read the repositionable dial indicator (.001"). Dial indicator 66962 included.

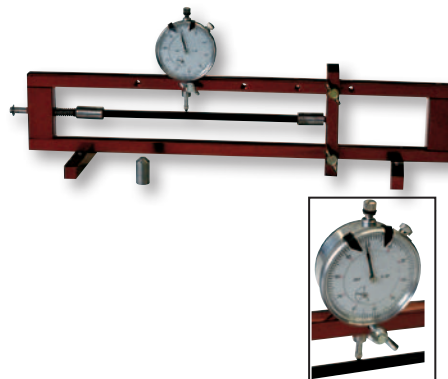

66979.....Universal Straightness Checker



## Self-Powered Timing Light

PROFORM's affordable self-powered timing light eliminates the difficulty of setting your ignition timing. Each lightweight unit comes standard with 2 D-size batteries, and built-in flashlight. No battery leads needed, so it's easy to use! Effortless 1-wire hookup, simply connect slide trigger open, place over # 1 wire, and close! Durable, theft-resistant clamshell packaging that's great for any retail environment!

67414 ..... Self-Powered Timing Light



## 6 pc Telescoping Gauge Set

Quickly measure everything from diameter to grooves to hard-to-reach recesses with the PROFORM Telescoping Gauge Set. Simply insert the gauge (six sizes to choose from) into the area and turn the knob. The spring-fed arms will snap to outer-edges. Now, tighten the knob to lock the inside measurement. Comes with six gauges ranging from 5/16" to 6" and a durable carrying case.

67412 ..... 6 PC Telescoping Gauge Set



## Micrometer Sets

- 67430.....Micrometer 0" - 1"/.0001" (Shown)
- 67431.....Micrometer 1" - 2"/.0001"
- 67432.....Micrometer 2" - 3"/.0001"
- 67433.....Micrometer 3" - 4"/.0001"
- 67434.....Micrometer 4" - 5"/.0001"
- 67435.....Micrometer 5" - 6"/.0001"
- 67436.....Micrometer Set 0" - 3"/.0001"
- 67437.....Micrometer Set 0" - 4"/.0001"
- 67438.....Micrometer Set 04" 6"/.0001"



## Professional Dial Bore Gauge

Easily determine the dimensions of your rod and cylinder bores with our Professional Dial Bore Gauge. This unit features a 2" - 6" range with extendable handle and comes in a durable carrying case.

67411 ..... Dial Bore Gauge 2" - 6"/.0005"



## Tire Pressure Gauges

Quickly and easily gauge tire pressure with PROFORM's easy-to-use tire pressure gauges. 1 1/2" diameter face and heavy-duty shatterproof glass make this tool a must have for every tool box at the track. NOTE: 67402 does not have an extension hose.



- 67402 ..... Tire Pressure Gauge 1 - 100 lbs.  
 67403 ..... Tire Pressure Gauge 0 - 60 lbs.  
 67404 ..... Tire Pressure Gauge 0 - 15 lbs.

## Oil Pressure Tester

Easily check engine oil pressure on your domestic or foreign auto with the PROFORM Oil Pressure Tester. Each tester features 0 - 100 psi and 0 - 700 kpa readings with a 24" hose.

- 67405 ..... Oil Pressure Tester

## Remote Starter Switch

No more jumping from under the hood, to the front seat, to under the hood! Easily test your engine with the PROFORM Remote Starter Switch.



- 67406 ..... Remote Starter Switch

## 14MM Adapter

This long reach 14MM adapter allows you to easily work on long spark plug holes. The adapter screws into 14MM spark plug holes.



- 67407 ..... 14MM Adapter

## Spark Plug Indexing Tool

Avoid stripped spark plug holes with our affordable spark plug hole thread chaser. Double ended to fit 14mm and 18mm threads.

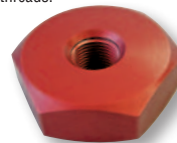

- 66795 ..... Spark Plug Indexing Tool

## Economy Valve Spring Compressor, Stud Style



- 66848 ..... Economy Valve Spring Comp, Stud-Style

## Chrysler Spring Compressor, Shaft Mounted

Heavy-duty shaft mounted spring compressor makes removing valve springs while the cylinder heads are still on the engine a snap. Bolt the tool shaft in lieu of the rocker shaft, place the feet over retainer, put the handle on and pull down. That easy!

- 67460... Shaft Mounted Chrysler Spring Compressor, S/B  
 67461... Shaft Mounted Chrysler Spring Compressor, B/B

## Vacuum Pressure Gauge

Perfect for a variety of automotive tests (except parallel parking!) including fuel pumps and intake manifolds. Easy-to-read gauge with 30" vacuum and 60 lbs pressure. Each gauge comes with gauge, hose, small brass cone and large rubber cone.

- 67410 ..... Vacuum Pressure Gauge

## Super Straight Edge

PROFORM's new super straight edge tools allow you to easily check the straightness and flatness of your cylinder heads, engine blocks, or any flat surface. These durable heat-treated steel tools with a protective epoxy coating and plastic edge cover, plus a handy hanging hole for your shop wall.

- 67420 ..... Super Straight Edge 24-inch.  
 67421 ..... Super Straight Edge 36-inch.

## 6 and 12 Volt Circuit Tester

- 67408 ..... 6 and 12 Volt Circuit Tester



# PROFORM

Available in 16 Styles!

Now Available



NEW Chevy® Orange and Carbon-style Looks!



**CHEVROLET**  
**PERFORMANCE**  
OFFICIAL LICENSED PRODUCT

**LS SLANT-EDGE VALVE COVERS**

**Ford** | **FORD PERFORMANCE**

Official Licensed Product

Available in 11 Styles!



NEW Carbon-style!



Available in 5 Colors for Chevy, Ford!

Aluminum Race and Street Carbs, 600-1050 CFM!



Aluminum Roller Rockers for Chevy, Ford, Mopar, Pontiac, Olds, and AMC!

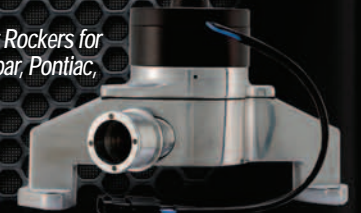

100% New Distributors for Chevy, Ford, Pontiac, Olds, Ford, and Mopar!



Engine Builders' Tools!



67025C

Aluminum Covers for GM, Ford, and Dana 60!

**PERFECT LAUNCH**



Apple iTunes Search: Perfect Launch



INDEX

Table with 4 columns of alphanumeric codes and numbers, ranging from 0392022002 to 66815.





**INNOVATIVE  
AND  
AFFORDABLE  
PRODUCTS  
FROM  
SPECIALTY AUTO  
PARTS USA, INC!**

**SPECIALTY AUTO PARTS USA, INC.**



**FORD PERFORMANCE**



**PERFORMANCE**  
OFFICIAL LICENSED PRODUCT

**PROFORM**