



## **PRO COMP SUSPENSION**

---

Suspension Systems that Work!

**Part #  
52413B/52413BMX  
2005-2006  
Ford Super Duty  
4WD F250-F350  
Stage 1 Lift Kit  
with Add-A-Leaf**

This document contains very important information that includes warranty information and instructions for resolving problems you may encounter. Please keep it in the vehicle as a permanent record.

Part #	Description	Qty.	Illus.	Page
90-5093	TRACK BAR DROP BRACKET	1	1,3,9	6,7,12
90-6369	<b>HARDWARE PACK: Track Bar Drop</b>	1	-	-
70-0563001800	9/16" X 3" HEX BOLTS GR. 8	3	3	7
72-05600100816	9/16" STOVER NUTS ZINC	3	3	7
73-05600830	9/16" WASHER SAE GR. 8	6	3	7
90-6387	<b>HARDWARE PACK: Brake line</b>	1	-	-
90-2159	<b>BRAKE LINE SPACER TUBE</b>	2	-	-
90-2055	<b>SWAY BAR DROP SPACER</b>	4	7a	10
90-6315	<b>HARDWARE PACK: Sway Bar Drop Top</b>	2	-	-
70-0431751800	7/16" X 1 3/4" GR. 8 HEX BOLT	4	7a,7b	10
73-04300034	7/16" HARDENED FLAT WASHER	8	7a,7b	10
72-04300100816	7/16" GR. 8 STOVER NUT	4	7a,7b	10
90-6340	<b>HARDWARE PACK: Sway Bar Drop Bottom</b>	2	-	-
70-0431251800	7/16" X 1 1/4" GR. 8 HEX BOLT- (2 not used)	4	7a,7b	10
73-04300034	7/16" HARDENED FLAT WASHER- (4 not used)	8	7a,7b	10
72-04300100816	7/16" GR. 8 STOVER NUT- (2 not used)	4	7a,7b	10
90-6379	<b>HARDWARE PACK: Brake line</b>	1	-	-
70-0251751500	1/4" X 1 3/4" Gr. 5 BOLT	2	-	-
73-02500530	1/4" FLAT WASHER	4	-	-
72-025100512	1/4" NYLOCK NUT	2	-	-
90-1859	SWAY BAR DROP BRACKET	2	7a	10
90-2511	BUMP STOP SPACER	2	8	11
FD-700	PITMAN ARM	1	1	7
95-150F	1 1/2" LIFT BLOCK	2	10	15
95-100F	1" LIFT BLOCK	2	-	-
13-90180	U-BOLT	4	10	15
20-65471	<b>HARDWARE PACK: 5/8" Hi nuts &amp; Washers</b>	1	10	15
90-3198	STEERING STABILIZER BRACKET	1	7a,7b	10
90-6390	<b>HARDWARE PACK: Bump Stop</b>	1	-	-
70-0436501800	7/16" X 6 1/2" USS GR. 8 HEX BOLT	2	8	11
73-04300034	7/16" SAE FLAT WASHER	4	8	11
72-04300100816	7/16" USS GR.8 STOVER NUT	2	8	11
90-6337	<b>HARDWARE PACK: Leaf Spring</b>	1	-	-
97-165	10MM X 165MM CENTER PIN	2	10	15
72-01015008812	10MM-1.5 NUT (CENTER BOLT NUT)	2	10	15
96-5002	PITMAN ARM TOOL	1	2	7
90-6595	<b>HARDWARE PACK: Pitman Arm Tool</b>	1	-	-
-----	<b>Thread locker</b>	1	-	-
0431251800	7/16" X 1 1/4" GR. 8 HEX BOLT	1	2	7
04300030	7/16" FLAT WASHER	1	2	7
04300100512	7/16" NYLOC NUT	2	2	7

Box 2 of 4-PN 52413B/52413BMX-2

Part #	Description	Qty.	Illus.	Page
<b>90-6370</b>	<b>HARDWARE PACK: Radius Arm Drop</b>	<b>1</b>	-	-
70-0751501800	3/4" X 1 1/2" HEX BOLTS GR. 8	4	4	8
72-075100816	3/4" STOVER NUTS	6	4	8
73-07500830	3/4" WASHERS SAE GR. 8	12	4	8
70-0755001800	3/4" X 5 HEX BOLTS GR. 8	2	4	8
70-0431501800	7/16" X 1.5" HEX BOLTS GR.8	8	5	9
72-043100816	7/16" STOVER NUTS	8	5	9
73-04300830	7/16" WASHERS SAE GR. 8	16	5	9
<b>90-3166</b>	<b>RADIUS ARM DROP SIDE PLATE</b>	<b>2</b>	<b>4,5,6</b>	<b>8,9</b>
<b>90-3167</b>	<b>RADIUS ARM DROP SIDE PLATE (With Notch)</b>	<b>2</b>	<b>4,5,6</b>	<b>8,9</b>
<b>90-2509</b>	<b>SWAY BAR DROP SUPPORT TUBE</b>	<b>1</b>	<b>7a,7b</b>	<b>10</b>
<b>90-6386</b>	<b>HARDWARE PACK: Radius Arm</b>	<b>1</b>	-	-
<b>90-2507</b>	<b>RADIUS ARM SPACER TUBE</b>	<b>2</b>	<b>4</b>	<b>8</b>

Box 3 of 4-PN 52413B-3

<b>926553</b>	<b>FRONT SHOCKS</b>	<b>2</b>	-	-
<b>932008</b>	<b>REAR SHOCKS</b>	<b>2</b>	-	-

(OR) Box 3 of 4-PN 52413BMX-3

<b>MX6122</b>	<b>MX6 FRONT SHOCKS</b>	<b>2</b>	-	-
<b>MX6018</b>	<b>MX6 REAR SHOCKS</b>	<b>2</b>	-	-

Box 4 of 4-PN 52413B/52413BMX-4

<b>13128-1</b>	<b>ADD-A-LEAF</b>	<b>2</b>	<b>10</b>	<b>15</b>
----------------	-------------------	----------	-----------	-----------

**Special Tools:**

<b>Pitman Puller</b>	<b>Snap-On PN</b>	<b>CJ1119B</b>
<b>Tie Rod Separator</b>	<b>Ford PN</b>	<b>T64P-3590-F</b>

**The following parts are used in conjunction with this kit and must be purchased separately.**

<b>24514</b> OR	<b>COILS GASOLINE ENGINE</b>	<b>1</b>	-	-
<b>24515</b>	<b>COILS DIESEL ENGINE</b>	<b>1</b>	-	-

## Introduction:

- ◆ **This installation requires a professional mechanic!**
- ◆ We recommend that you have access to a factory service manual to assist in the disassembly and reassembly of your vehicle. It contains a wealth of detailed information.
- ◆ Prior to installation, carefully inspect the vehicle's steering and driveline systems paying close attention to the tie rod ends, ball joints, wheel bearing preload, pitman and idler arms. Additionally, check steering-to-frame and suspension-to-frame attaching points for stress cracks. The overall vehicle must be in excellent working condition. Repair or replace all worn or damaged parts!
- ◆ Read the instructions carefully and study the illustrations before attempting installation! You may save yourself a lot of extra work.
- ◆ Check the parts and hardware against the parts list to assure that your kit is complete. Separating parts according to the areas where they will be used and placing the hardware with the brackets before you begin will save installation time.
- ◆ Check the special equipment list and ensure the availability of these tools.
- ◆ Secure and properly block vehicle prior to beginning installation.
- ◆ **ALWAYS** wear safety glasses when using power tools or working under the vehicle!
- ◆ Use caution when cutting is required under the vehicle. The factory undercoating is flammable. Take appropriate precautions. **Have a fire extinguisher close at hand.**
- ◆ Foot pound torque readings are listed on the Torque Specifications chart at the end of the instructions. These are to be used unless specifically directed otherwise. Apply thread lock retaining compound where specified.
- ◆ **Please note that while every effort is made to ensure that the installation of your Pro Comp lift kit is a positive experience, variations in construction and assembly in the vehicle manufacturing process will virtually ensure that some parts may seem difficult to install. Additionally, the current trend in manufacturing of vehicles results in a frame that is highly flexible and may shift slightly on disassembly prior to installation. The use of pry bars and tapered punches for alignment is considered normal and usually does not indicate a faulty product. However, if you are uncertain about some aspect of the installation process, please feel free to call our tech support department at the number listed on the cover page. We do not recommend that you modify the Pro Comp parts in any way as this will void any warranty expressed or implied by the Pro Comp Suspension company.**

## Please Note:

- ⇒ Front suspension and head light realignment is necessary!
- ⇒ Speedometer and ABS recalibration will be necessary if larger tires (10% more than stock diameter) are installed.
- ⇒ IT IS ADVISABLE THAT YOU HAVE HELP AVAILABLE WHEN INSTALLING THIS KIT. SOME COMPONENTS ARE HEAVY AND AWKWARD. AN ADDITIONAL SET OF HANDS IS GOOD INSURANCE AGAINST INJURY!

## **Important!**

Due to differences in manufacturing, dimensions and inflated measurements, tire and wheel combinations should be test fit prior to installation. Tire and wheel choice is crucial in assuring proper fit, performance, and the safety of your Pro Comp equipped vehicle. For this application, we recommend a wheel not to exceed 9" in width with a maximum backspacing of 5 3/4" must be used. Additionally, a quality tire of radial design, not exceeding 35" tall X 12.5" or 13.50" wide is also recommended. Violation of these recommendations will not be endorsed as acceptable by Pro Comp Suspension and will void any and all warranties either written or implied.

## **Before You Begin:**

- ⇒ Read the instructions and study the illustrations before attempting the installation.
- ⇒ Separating the parts according to the areas where they will be used and placing the hardware with the brackets before you begin will save installation time.
- ⇒ Check the parts and hardware against the parts list to assure that your kit is complete.
- ⇒ ALWAYS wear safety glasses when using power tools or working beneath your vehicle.
- ⇒ A pitman arm removal tool and tie rod separating tool are required to perform the installation. See the special tools at the bottom of page 3.
- ⇒ Always use NEW cotter pins on re-assembly! (These items are NOT supplied)

### **Optional Equipment Available from your Pro Comp Distributor!**

**22415 REAR LEAF SPRINGS,  
LIGHTS,  
52480 CARRIER BEARING SHIM KIT,  
599 ALIGNMENT CAM KIT,  
50191 U-Bolt Kit,  
72400: TRACTION BARS,  
72099: TRACTION BAR MOUNTING KIT  
219567: DUAL STEERING STABILIZER  
99-400: 4 DEGREE REAR AXLE SHIM KIT**  
Also, check out our outstanding selection of Pro Comp tires  
to compliment your new installation!

## Front Installation:

1. Position your vehicle on a smooth, flat, hard surface (i.e. concrete or asphalt). Block the rear tires and set the emergency brake.
2. Measure and record the distance from the center of each wheel to the top of its fender opening. Record below.

LF: \_\_\_\_\_ RF: \_\_\_\_\_

LR: \_\_\_\_\_ RR: \_\_\_\_\_

3. Place the vehicle in neutral. Place your floor jack under the front axle and raise the vehicle. Place jack stands under the frame rails and lower the frame onto the stands. Remove the jack and place the vehicle back in gear, set the emergency brake, and place blocks both in front and behind the rear wheels.
4. Remove the track bar bolt from the driver side frame mount. Save this hardware for re-use.
5. Remove cast track bar mount on driver side of frame. Save the bolts and pal nuts. Hardware will be reused.
6. Unbolt the sway bar from the sway bar end links on both sides of the vehicle. Rotate forward out of the work area.
7. If the vehicle is equipped with a factory steering stabilizer unbolt it from the frame mounting bracket and remove the factory bracket from the frame.
8. Remove the cotter pin and nut from drag link. Save the nut for reinstallation. Use a tie rod separator to separate drag link from Pitman arm.
9. Remove the sector Pitman arm retaining nut and save for reinstallation. Use a Pitman arm puller to remove the **OE** pitman

arm. The threads of the sector shaft and the Pitman arm retaining nut must be cleaned of all factory dry adhesive.

**IMPORTANT!: THE ENTIRE INSTALLATION PROCESS MUST BE DONE WITH HAND TOOLS TO ENSURE PROPER INSTALLATION. DO NOT USE IMPACT TOOLS.**

10. Install new pitman arm on sector shaft. Oil the sector shaft threads to ensure a proper torque reading. Install Pitman arm retaining nut and tighten until snug. See **Illustration 1**.
11. Insert the key and unlock the steering wheel.
12. Install the Pitman arm torque tool (**90-5002**) to the Pitman arm using one of the previously removed **OE 14mm** track bar bracket outer retaining bolt and nut plate. See **Illustration 2**.

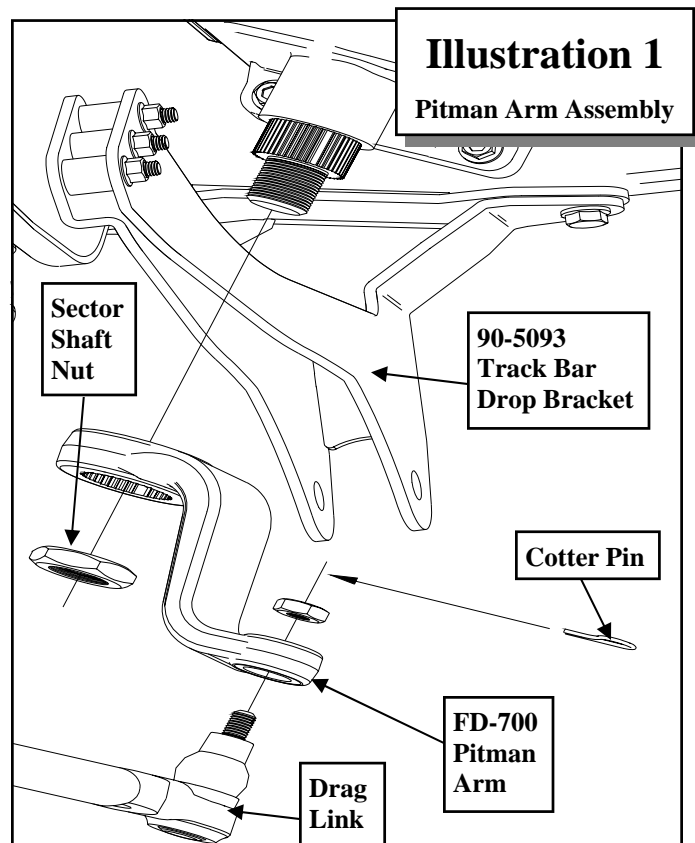

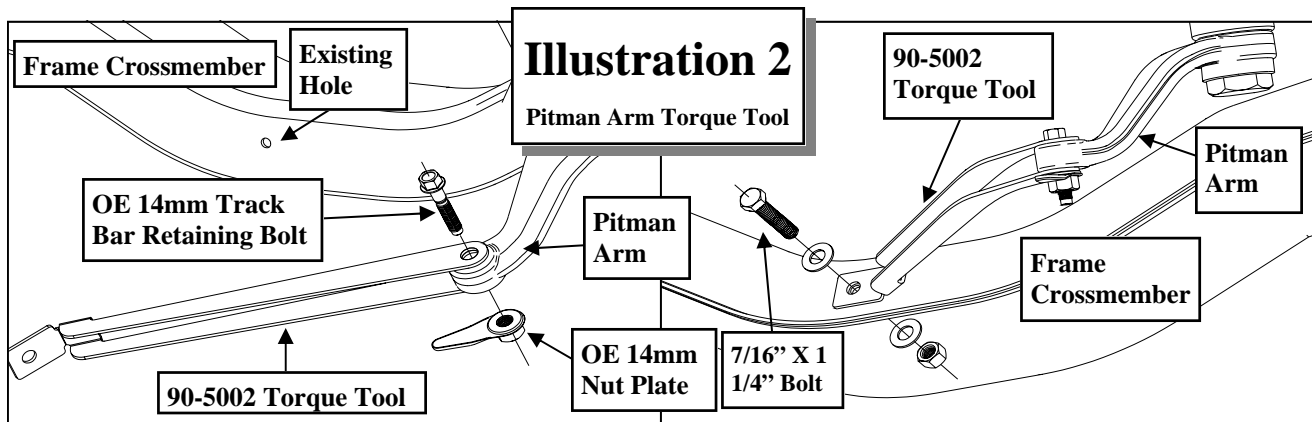

- Secure the torque tool (90-5002) to the existing hole in the frame crossmember using the supplied 7/16" X 1 1/4" bolt and hardware. See Illustration 2.

**NOTE:** The steering wheel may need to be turned in order for the hole in the torque tool and the frame crossmember to line up. Once the bolts are tightened the torque tool will align itself properly.

**NOTE:** The use of the torque tool is to keep the Pitman arm from moving

*right or left, but allow for movement up the sector shaft. If you do not have this tool, a length of chain or a flat bar with two holes is a suitable replacement.*

- Torque the Pitman arm retaining nut to 375 ft./lbs.
- With the torque tool (90-5002) still in place remove the pitman arm retaining nut. The threads of the sector shaft and the Pitman arm retaining nut **MUST** be cleaned using brake cleaner or another suitable method to remove the previously applied oil.
- Use the entire supplied thread locking compound to thoroughly cover the entire surface of the threads on the Pitman arm retaining nut.
- Reinstall the Pitman arm retaining nut to the sector shaft and torque to 350 ft./lbs.
 

**NOTE:** Whether re-using the existing pitman arm retaining nut or replacing with a new nut, the supplied locking compound must be used.
- Unbolt and remove the Pitman arm torque tool (90-5002) from the vehicle.

**NOTE:** Save this Pitman arm torque tool to add to your toolbox for any future Pitman arm installations.

- Install track bar drop bracket (90-5093) using (3) 9/16" X 3" and (2) OE bolts. Use thread locker on the bolts. Torque OE the bolts to 129 ft. lbs. and the 9/16"

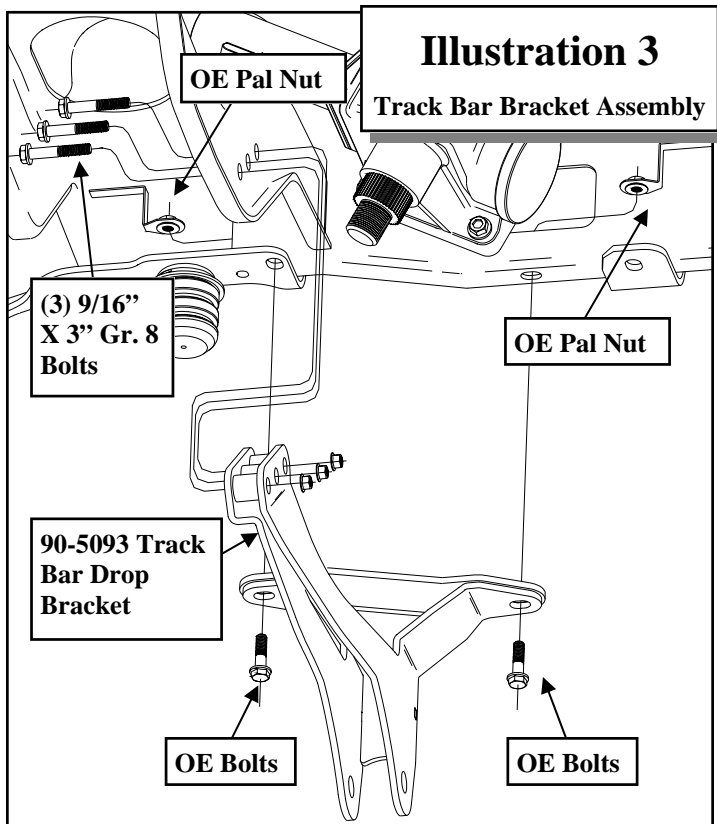

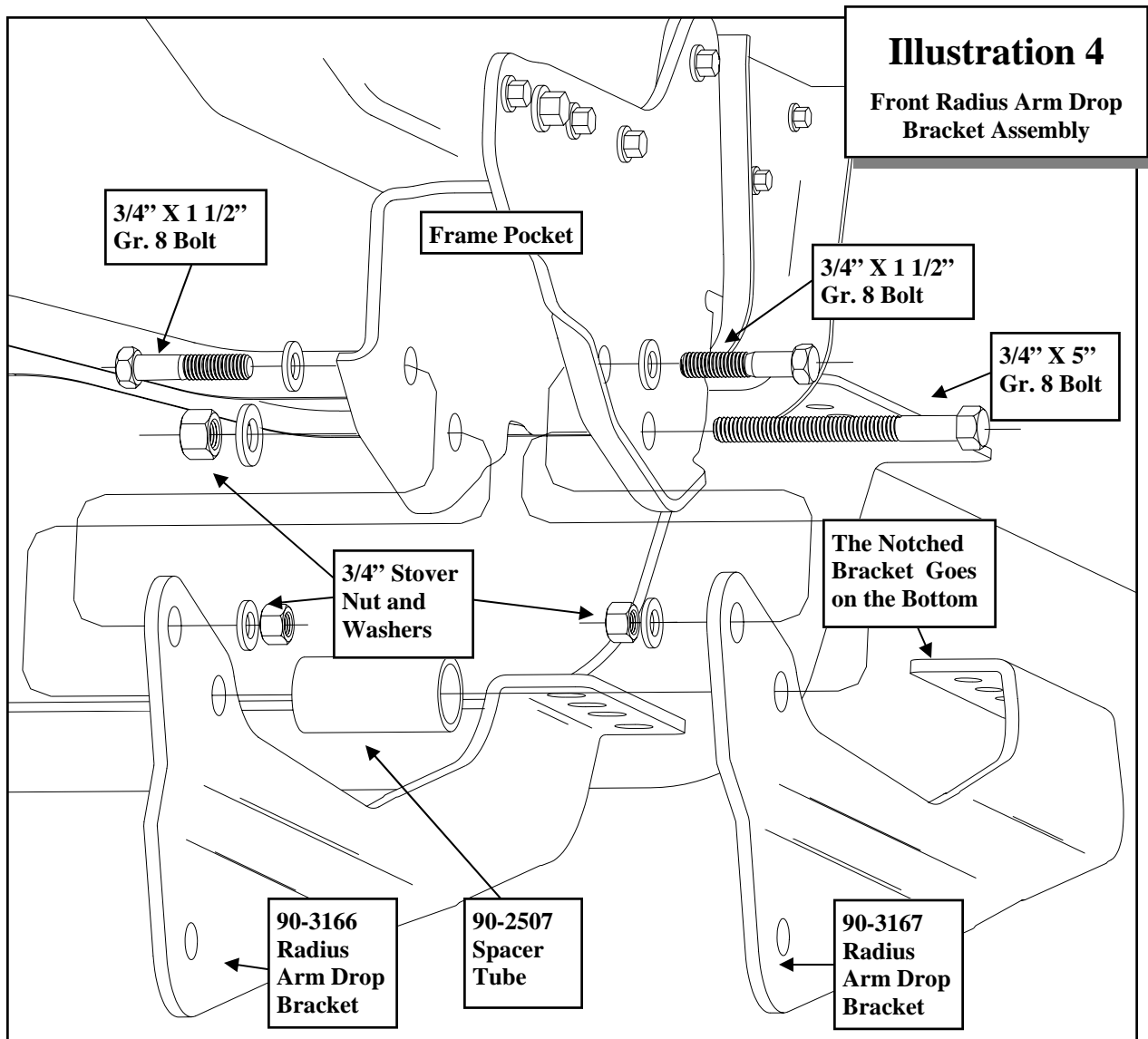

bolts to 110 ft. lbs. See ILLUSTRATION 3.

20. Unbolt the front brake line bracket from the lower spring perch. Save hardware for reuse.
21. Unbolt and unclip the ABS wiring connected to the radius arm. Save hardware for reuse.
22. On the driver side, unclip the axle vent line from inside the frame.
23. On the passenger side unclip the axle hub vacuum line from inside of the axle bump stop plate.

24. Remove the transfer case skid plate. Also remove the rubber grommets, sleeves and clips from the frame.

25. Place a jack under the pinion or radius arm. On both sides remove the rear bolts holding the radius arms to the frame of the vehicle.
26. Carefully rotate both radius arms down to provide adequate space to install the new drop brackets.
27. On both sides of the vehicle, assemble the radius arm drop side plates (**90-3166 on top**) and (**90-3167, with the notch in it, on the bottom**) and bolt radius arm drop



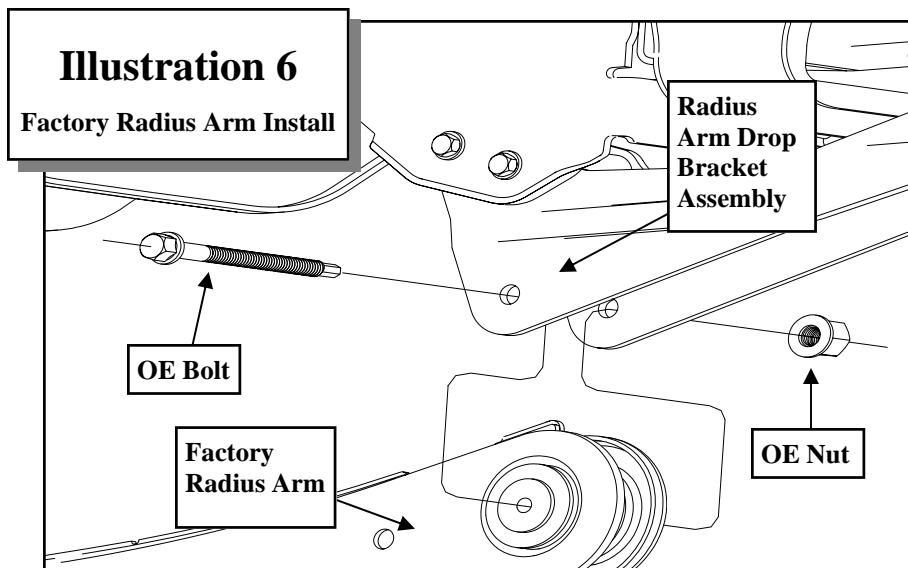
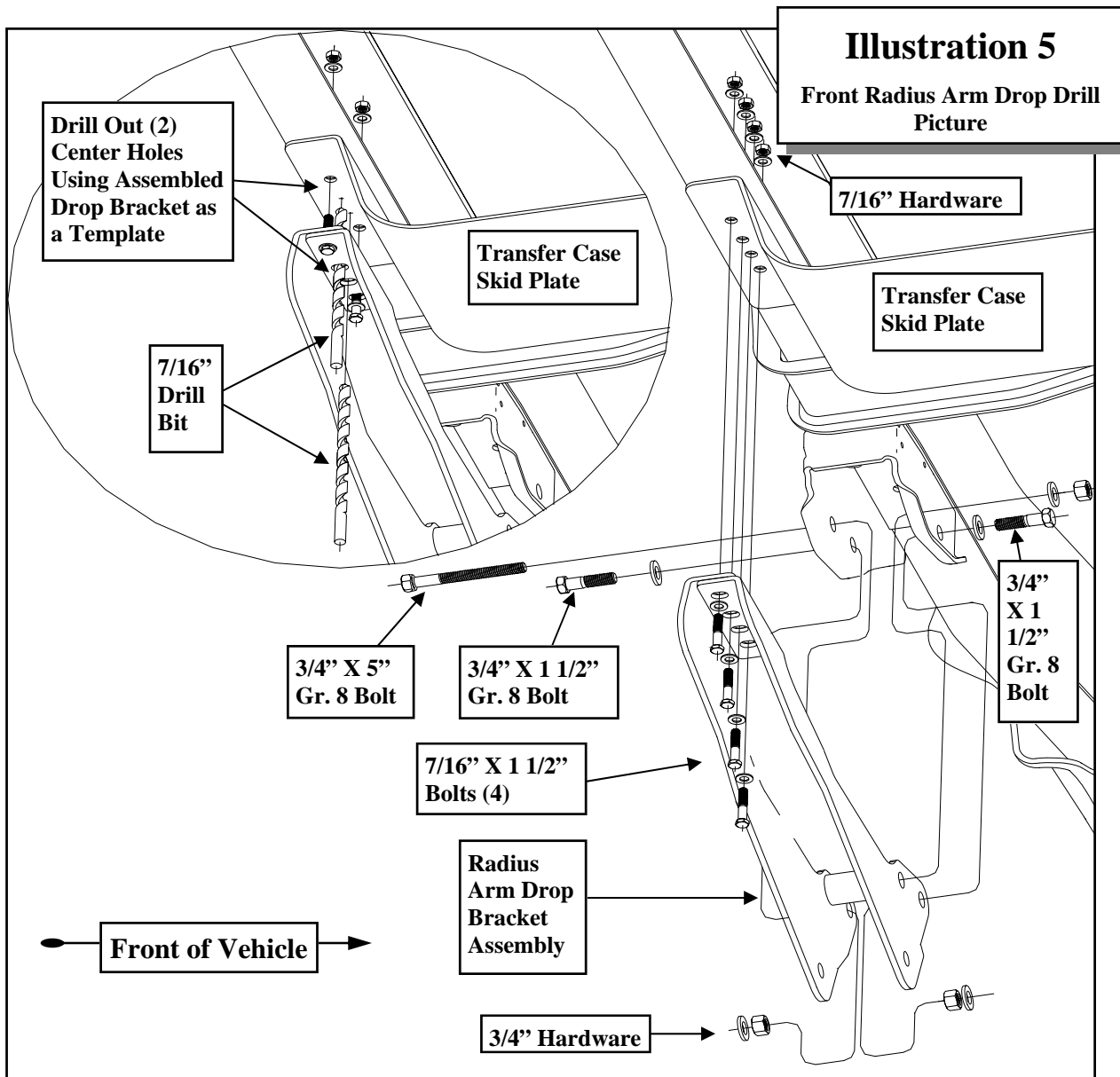

# Illustration 7a

## Sway Bar Drop Assembly

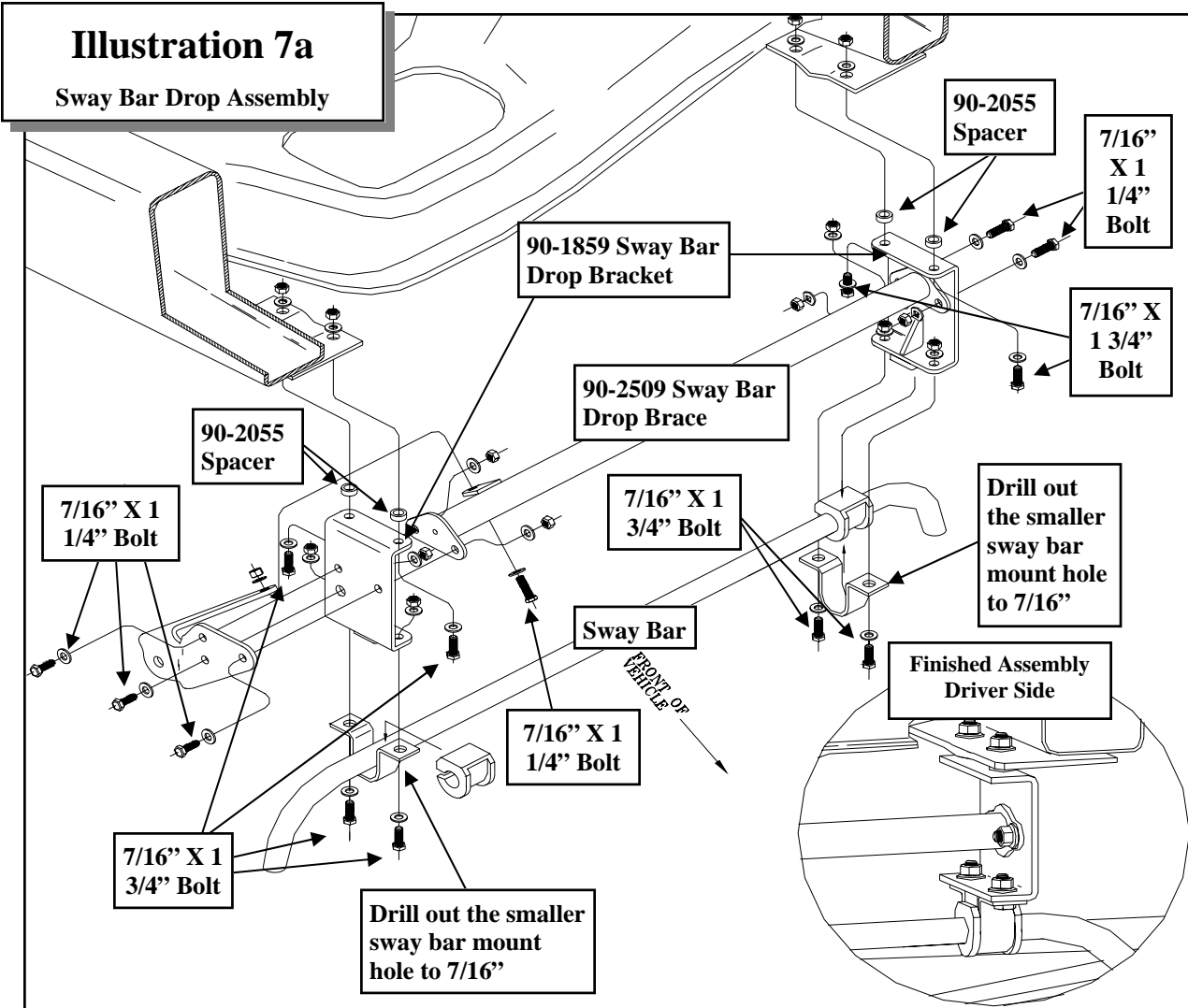

# Illustration 7b

## Passenger Side Steering Stabilizer Bracket

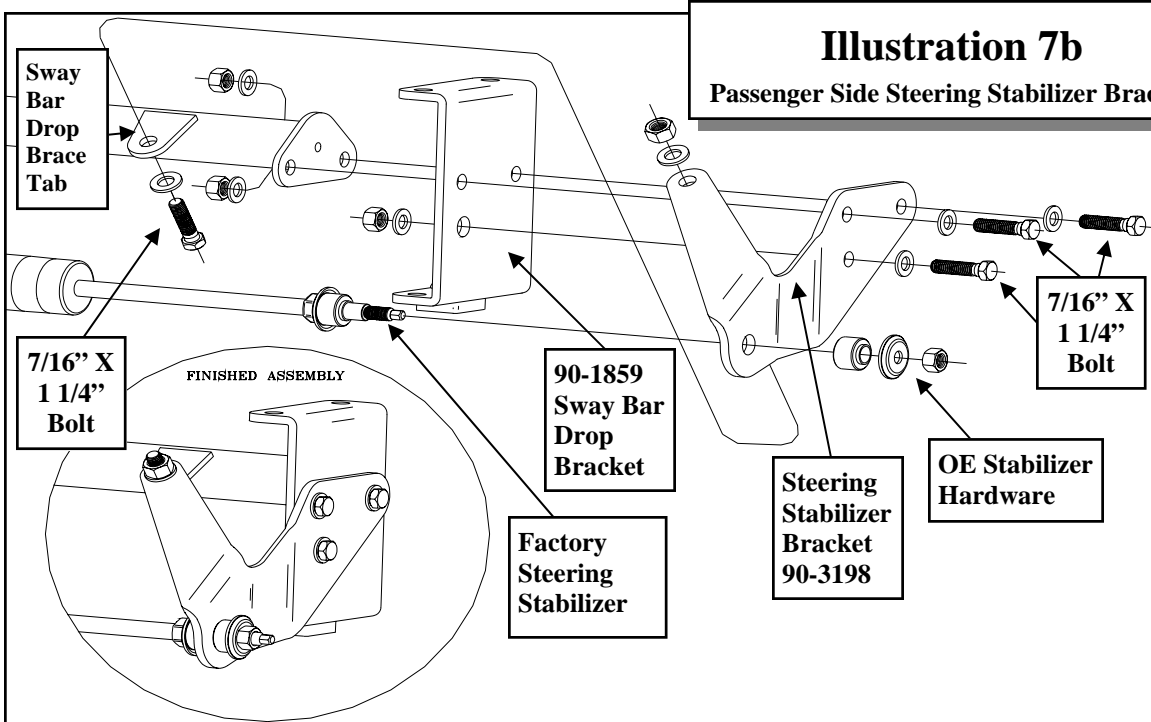

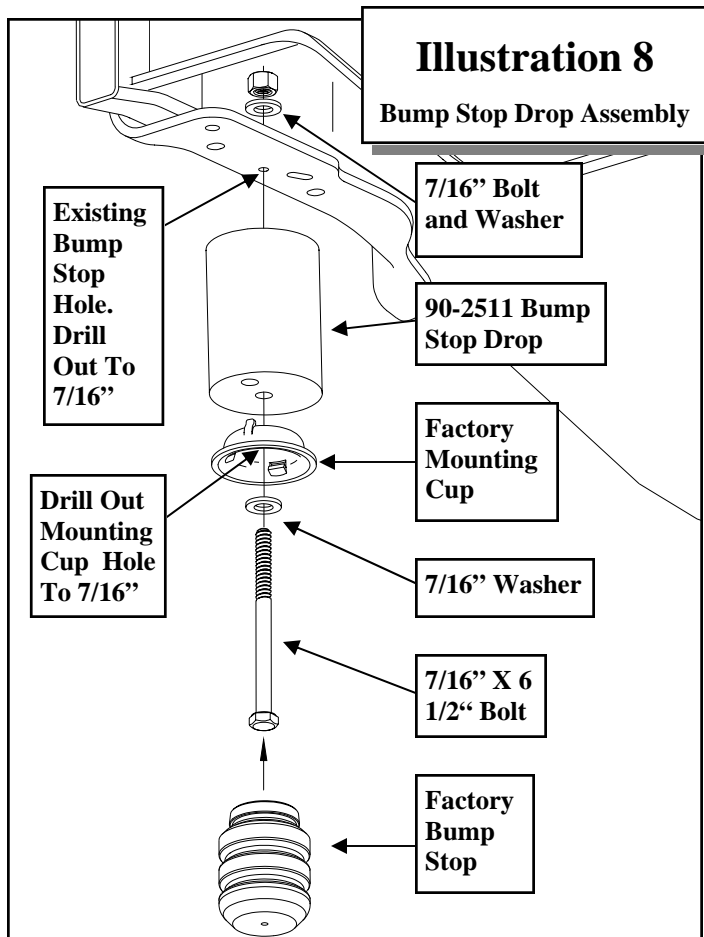

to the frame. Use the supplied  $3/4'' \times 1 1/2''$  bolts in the front hole with the heads of the bolts facing out. Do not torque at this time. See ILLUSTRATION 4.

28. Use the spacer tube (90-2507) and the  $3/4'' \times 5''$  bolt in the rear hole. Do not torque at this time. See ILLUSTRATION 4.
29. From the rear, slide the previously removed transfer case skid plate in between the frame and the rear of the radius arm drop bracket. Insert (2)  $7/16'' \times 1 1/2''$  bolts through the outside holes in the rear of the drop bracket and skid plate. Tighten these bolts and use the radius arm bracket holes as a drill template to drill out the (2) inside holes in the factory skid plate and frame. Drill the holes using a  $7/16''$  drill bit. Insert the remaining (2)  $7/16'' \times 1 1/2''$  bolts in the newly drilled

holes. See ILLUSTRATION 5.

30. Raise the factory radius arm into the lower hole in the drop bracket. Secure using the OE bolt. Do not tighten this bolt until vehicle is on the ground. See ILLUSTRATION 6.
31. Torque the  $7/16''$  radius arm drop bracket hardware to 60 ft. lbs. and the  $3/4''$  hardware to 200 ft. lbs.
32. Remove the sway bar and factory clips from the frame on both sides of the vehicle. Note orientation of the sway bar for reinstallation.
33. Install sway bar drop brackets (90-1859). Assemble all components shown before you begin to tighten any hardware. Use the (4)  $7/16'' \times 1 3/4''$  bolts, hardware and spacers (4) (90-2055) to secure the drop brackets to the frame. See ILLUSTRATION 7a.
34. On the driver side, bolt the sway bar support tube (90-2509), above the lower radiator hose and cooler lines, to the drop bracket with (2)  $7/16'' \times 1 1/4''$  and hardware. See ILLUSTRATION 7b.
35. On the passenger side, bolt the sway bar support tube (90-2509) and steering stabilizer bracket (90-3198) to the sway bar drop bracket using the (3)  $7/16'' \times 1 1/4''$  and hardware. Use (1)  $7/16'' \times 1 1/4''$  and hardware to bolt the steering stabilizer bracket to the tab on the sway bar support tube. See ILLUSTRATION 7b.

**NOTE:** If installing a PRO COMP double shock hoop kit skip the following step.

36. Bolt the factory sway bar to the drop brackets using the (4)  $7/16'' \times 1 3/4''$  bolts and hardware. See ILLUSTRATION 7a.

**NOTE:** The smaller hole on each factory sway bar mount needs to be drilled out to  $7/16''$  to accommodate the supplied

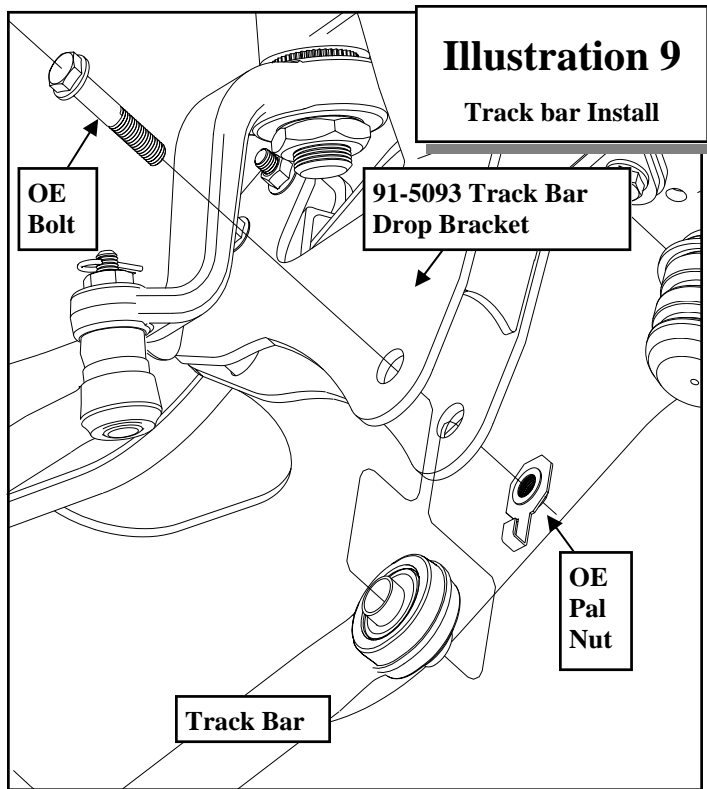

**7/16" bolts.**

37. Torque all **7/16"** sway bar hardware to 50 ft. lbs.
38. Raise the front axle enough to relieve tension on the shock hardware and remove the shocks from the vehicle.
39. Lower the front axle enough to remove the coil springs from the front spring pockets. Save the factory isolators for reuse.

**NOTE: Be sure to support the axle while the springs and shocks are removed.**

40. Unbolt the front brake line bracket from the upper spring bucket.
41. Measure approximately **6"** down from the mounting hole for the brake line bracket on the spring bucket. Center punch and drill a new **17/64"** hole for the new brake line mounting position.
42. Using the brake line spacer (**90-2159**) and supplied **1/4" X 1 3/4"** bolt to secure the

factory brake line to the newly drilled hole in the spring bucket. Carefully bend the bracket away from the frame to keep the lines and bracket from rubbing.

**NOTE: Carefully pull down and bend the metal brake line down to create enough slack to accommodate the new lower mounting position. Be sure to tuck the lines back up under the frame.**

**NOTE: On the driver side make sure that the metal brake line does not come in contact with the steering shaft, rag joint or any moving parts or non-moving parts.**

43. Remove the factory front bump stop from the bump stop mounting cup. Pliers and a back and forth rocking motion will assist in removal of the bump stop.
44. On the driver side, unbolt the bump stop mounting cup and drill out the factory hole in the frame and bump stop mounting cup to **7/16"**.
45. On the passenger side, unbolt the bump stop mounting cup. Measure in toward the engine **5/8"** from the center of the factory bump stop hole in the frame. Center punch and drill and the new hole **7/16"** in the frame. Drill out the bump stop mounting cup to **7/16"**.

**NOTE: If installing a PRO COMP double shock hoop kit do so at this time.**

46. Use the supplied **7/16" X 6 1/2"** bolt and hardware to bolt the bump stop drop (**90-2511**) and mounting cup to the bump stop hole in frame. See ILLUSTRATION 8.

**NOTE: Be sure to fit the tab from the mounting cup into the hole in the drop.**

47. Reinstall the previously removed factory bump stop into the mounting cup on the new bump stop drop. See ILLUSTRATION 8.
48. Using the factory isolators install the supplied front coil springs (**24514 Gas or**

**24515 Diesel**) into the spring buckets and raise the axle into place. Make sure the coil spring seats properly on the lower spring perch.

49. Install the new shocks (**PN 926553 or MX6122**). Torque the upper mounting hardware to 46 ft. lbs. and the lower mounting hardware to 111 ft. lbs. Use thread locker on these bolts.
50. Install draglink end into pitman arm and torque draglink nut to 148 ft. lbs. Reinstall cotter pin.
51. Install the steering stabilizer stem to the new pro comp bracket (**90-3198**) using the previously removed **OE** hardware. See ILLUSTRATION 7b.

**NOTE: If installing a PRO COMP double shock hoop kit skip the following step.**

52. Re-attach the sway bar to the sway bar end links and fasten to 111 ft. lbs.
53. On the driver side, re clip the axle vent line on the frame providing adequate slack for the line at full droop.
54. On the passenger side, reposition the clip on the axle hub vacuum line to provide adequate slack to re-clip the line to the existing hole on the outside of the bump stop plate.

**NOTE: Be sure that the newly re-routed vent line does not interfere with the travel of the bump stop.**

55. Remove the ABS line from the inner fender. Drill a new hole, using a **15/64"** bit, **3"** lower in the fender to provide adequate slack for line and reattach the ABS line.
56. Reinstall the ABS wiring onto the radius arms using the factory clips.
57. Refasten the lower brake line mount to the lower coil spring perch using the **OE** hardware.

58. Reinstall the front wheels and lower the vehicle to the ground. Torque to manufacturers specs.

59. Torque the **OE** rear Radius arm bolts to 222 ft. lbs.
60. Reinstall the track bar into the Pro Comp track bar bracket (**90-5093**) using the **OE** bolt. Torque to 406 ft. lbs. See ILLUSTRATION 9.

**NOTE: You may find that having someone inside the vehicle and moving the steering wheel from side to side will aid in the alignment of the track rod. DO NOT start the engine for this! You only have to move it enough to line the holes up on the track bar mount.**

61. On both sides of the vehicle, check the routing of the brake lines and the ABS wire harnesses. There must be no pinching, rubbing, or stretching of either component. At full droop, cycle the steering from lock to lock while observing the reaction of these components. Reposition them if needed.

#### **NOTES:**

- ⇒ **On completion of the installation, have the suspension and headlights re-aligned.**
- ⇒ **After 100 miles recheck for proper torque on all newly installed hardware.**
- ⇒ **Recheck all hardware for tightness after off road use.**

## Rear Installation:

1. Block the front tires and raise the rear of the vehicle. Support the frame with jack stands forward of the rear springs.
2. Remove the wheels and tires.
3. Remove the shocks on both sides of the vehicle. It may be necessary that you slightly raise the axle to unload the shocks for removal.
4. On the driver side, unbolt the emergency brake line bracket from the upper spring plate. Save hardware for reuse.
5. If your vehicle is equipped with factory sway bar, unbolt it from the end links.
6. Support the rear axle with a floor jack and remove the **U-bolts** on the driver side. Slightly loosen the **U-bolts** on the passenger side.
7. Lower the rear axle and remove the factory block.

**NOTE:** *Be sure not to over extend the rear brake line and rear axle vent line.*

8. While supporting the rear leaf spring, remove the factory spring mounting bolts and remove the leaf spring from the driver side only at this time.
9. Carefully bend open the front leaf spring alignment clamp. Use C-clamps to hold leaves together and remove spring center bolt.
10. Disassemble leaf spring and insert add-a-leaf (**13128-1**) with the short side facing toward the front. The add-a-leaf will provide approximately **1 1/2"** of lift. See ILLUSTRATION 10.

**NOTE:** *Add-a-leaf will be placed in the spring assembly progressively according to length. For example, if the existing leaves are 32" long and 25" long and the add-a-leaf is 28" long, place the add-a-leaf*

*between the existing leaves.*

11. Using the C-clamps, re-clamp and bolt the leaf pack back together using the supplied center bolt with the head of the bolts facing down and the nut on the top. Bend the front leaf spring alignment clamp back around the leaves, including the newly installed add-a-leaf.
12. Reinstall the spring pack to the hangers using the **OE** hardware. Do not torque at this time.

**NOTE:** *If installing traction bar kit 72099 install the rear mount at this time.*

### APPLICATIONS:

\* **FOR VEHICLES EQUIPPED WITH THE FACTORY 4" BLOCK, INSTALL THE ADD-A-LEAF (13128-1), THE FACTORY BLOCK AND EITHER THE 1 1/2" ALUMINUM BLOCK (95-150F) OR THE 1" ALUMINUM BLOCK (95-100F). DO NOT STACK ALL 3 BLOCKS IN THIS APPLICATION.**

\* **FOR VEHICLES EQUIPPED WITH THE FACTORY 2 1/4" BLOCK, INSTALL THE ADD-A-LEAF (13128-1), THE FACTORY BLOCK AND THE 1 1/2" ALUMINUM BLOCK (95-150F). IF NEEDED THE 1" ALUMINUM BLOCK (95-100F) CAN ALSO BE INSTALLED. ALL 3 BLOCKS AND THE ADD-A-LEAF CAN BE USED IN THIS APPLICATION.**

**See ILLUSTRATION 10.**

13. Reinstall the factory block and either the **1 1/2"** aluminum lift block (**95-150F**) or **1"** aluminum lift block (**95-100F**) or both

## Illustration 10

### Rear Spring with Add-A-Leaf Assembly

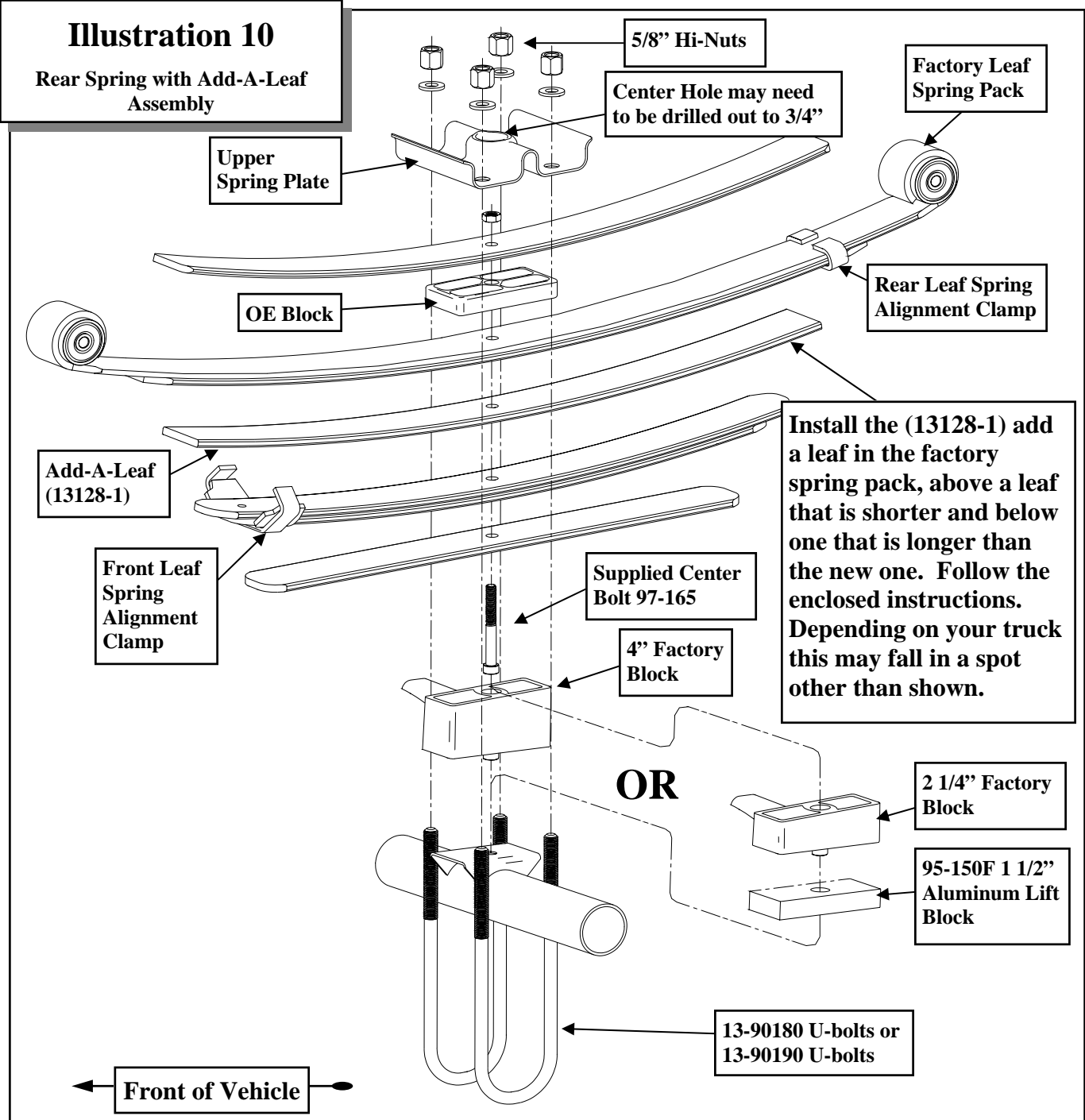

### Add-A-Leaf Rear Spacer Options:

1. 4" Factory block plus the add-a-leaf (13128-1) and either the 1 1/2" lift block (95-150F) or the 1" lift block (95-100F).

**OR**

2. 2 1/4" Factory block plus the add-a-leaf (13128-1), 1 1/2" lift block (95-150F) and 1" lift block (95-100F) if needed

See Inset box after step 12.

depending on application. See the side note for proper applications. Make sure the pin fits into the hole on the spring perch. Use your floor jack to raise the axle to the spring making sure the pin on the factory leaf spring assembly fits into the hole on the lift block. Secure the assembly with the **5/8" U-bolts (PN 13-90180) or (PN 13-90190 from block kit 50191 for vehicles not equipped with a factory overload spring), 5/8" hi-nuts (PN 20-65471)** and washers supplied. Do not torque the hi-nuts at this time. See ILLUSTRATION 10.

***NOTE: Make sure the block sits flush on the axle perch.***

14. Repeat the installation on the other side of the vehicle.
15. On driver side, carefully bend down the emergency brake line bracket that secures the line to the frame and bolt the emergency brake line bracket back on to the upper spring plate.
16. Install your new Pro Comp shocks (**PN 932008 or MX6018**). Torque the upper mounting hardware to 46 ft. lbs. and the lower mounting hardware to 66 ft. lbs. Use thread locker on these bolts.
17. If vehicle came equipped with a rear sway bar, Re-attach the rear sway bar to the end links. Secure with the previously removed **OE** hardware.
18. Reinstall the wheels and tires and lower the vehicle to the ground. Torque lug

nuts to manufacturer specification.

19. Torque the spring mounts at this time. The front bolts are torqued to 250 ft. lbs. and the rear bolts are torqued to 185 ft. lbs. Torque the **5/8" U-bolts** to 120 ft. lbs.
20. Re-check the wheel lug torque on all four wheels at this time.
21. Re-check all hardware (both the front and the rear) for proper installation and torque!!
22. If you wish, you may trim the excess u-bolt thread length. If you do this you should leave approximately one inch of thread exposed after the **U-bolts** are torqued.
23. On both sides of the vehicle, check the routing of the brake lines and the ABS wire harnesses. There must be no pinching, rubbing, or stretching of either component. Reposition them if needed.

#### **NOTES:**

- ⇒ **On completion of the installation, have the suspension and headlights re-aligned.**
- ⇒ **After 100 miles recheck for proper torque on all newly installed hardware.**
- ⇒ **Recheck all hardware for tightness after off road use.**



Use this only as a guide for hardware without a called out torque specification in the instruction manual.

<b>Bolt Torque and ID</b>						
<b>Decimal System</b>			<b>Metric System</b>			
All Torques in Ft. Lbs. Maximums						
Bolt Size	Grade 5	Grade 8	Bolt Size	Class 9.8	Class 10.9	Class 12.9
5/16	15	20	M6	5	9	12
3/8	30	45	M8	18	23	27
7/16	45	60	M10	32	45	50
1/2	65	90	M12	55	75	90
9/16	95	130	M14	85	120	145
5/8	135	175	M16	130	165	210
3/4	185	280	M18	170	240	290

1/2-13x1.75 HHCS    **Grade 5    Grade 8**  
(No. of Marks + 2)

D T L X

M12-1.25x50 HHCS

D T L X

G = Grade (Bolt Strength)  
 D = Nominal Diameter (Inches)  
 T = Thread Count (Threads per Inch)  
 L = Length (Inches)  
 X = Description (Hex Head Cap Screw)

P = Property Class (Bolt Strength)  
 D = Nominal Diameter (Millimeters)  
 T = Thread Pitch (Thread Width, mm)  
 L = Length (Millimeters)  
 X = Description (Hex Head Cap Screw)

### **Notice to Owner operator, Dealer and Installer:**

Vehicles that have been enhanced for off-road performance often have unique handling characteristics due to the higher center of gravity and larger tires. This vehicle may handle, react and stop differently than many passenger cars or unmodified vehicles, both on and off-road. You must drive your vehicle safely! Extreme care should always be taken to prevent vehicle rollover or loss of control, which can result in serious injury or even death. Always avoid sudden sharp turns or abrupt maneuvers and allow more time and distance for braking! Pro Comp reminds you to fasten your seat belts at all times and reduce speed! We will gladly answer any questions concerning the design, function, maintenance and correct use of our products.

### **Please make sure your Dealer/Installer explains and delivers all warning notices, warranty forms and instruction sheets included with Pro Comp product.**

Application listings in this catalog have been carefully fit checked for each model and year denoted. However, Pro Comp reserves the right to update as necessary, without notice, and will not be held responsible for misprints, changes or variations made by vehicle manufacturers. Please call when in question regarding new model year, vehicles not listed by specific body or chassis styles or vehicles not originally distributed in the USA.

**Please note that certain mechanical aspects of any suspension lift product may accelerate ordinary wear of original equipment components.** Further, installation of certain Pro Comp products may void the vehicle's factory warranty as it pertains to certain covered parts; it is the consumer's responsibility to check with their local dealer for warranty coverage before installation of the lift.

### **Warranty and Return policy:**

Pro Comp warrants its full line of products to be free from defects in workmanship and materials. Pro Comp's obligation under this warranty is limited to repair or replacement, at Pro Comp's option, of the defective product. Any and all costs of removal, installation, freight or incidental or consequential damages are expressly excluded from this warranty. Pro Comp is not responsible for damages and / or warranty of other vehicle parts related or non-related to the installation of Pro Comp product. A consumer who makes the decision to modify his vehicle with aftermarket components of any kind will assume all risk and responsibility for potential damages incurred as a result of their chosen modifications. Warranty coverage does not include consumer opinions regarding ride comfort, fitment and design. Warranty claims can be made directly with Pro Comp or at any factory authorized Pro Comp dealer.

**IMPORTANT!** To validate the warranty on this purchase please be sure to mail in the warranty card.

### **Claims not covered under warranty-**

- Parts subject to normal wear, this includes bushings, bump stops, ball joints, tie rod ends and heim joints
  - Discontinued products at Pro Comp's discretion
- Bent or dented product
- Finish after 90 days
- Leaf or coil springs used without proper bump stops
- Light bulbs
- Products with evident damage caused by abrasion or contact with other items
- Damage caused as a result of not following recommendations or requirements called out in the installation manuals
- Products used in applications other than listed in Pro Comp's catalog
- Components or accessories used in conjunction with other manufacturer's systems
- Tire & Wheel Warranty as per Pro Competition Tire Company policy
- Warranty claims without "Proof of Purchase"
- Pro Comp Pro Runner coil over shocks are considered a serviceable shock with a one-year warranty against leakage only. Rebuild service and replacement parts will be available and sold separately by Pro Comp. Contact Pro Comp for specific service charges.
- Pro Comp accepts no responsibility for any altered product, improper installation, lack of or improper maintenance, or improper use of our products.