

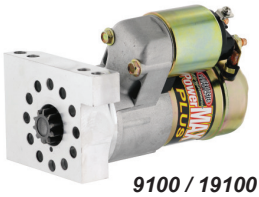

P/N 9100, 19100 CHEVY 153/168 TOOTH
 P/N 9103, 19103 FORD 157/164 TOOTH
 P/N 9109, 19109 CHEVY LS 168 TOOTH
 P/N 9112, 19112 CHEVY 168 TOOTH

INSTRUCTION SHEET

PowerMAX PLUS PMGR Starter



9100 / 19100

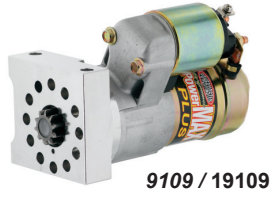

9109 / 19109

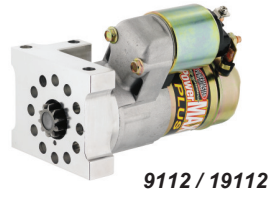

9112 / 19112

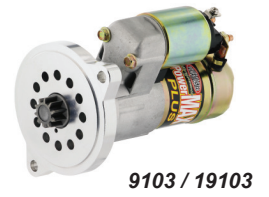

9103 / 19103

NOT FOR HI COMPRESSION RACING ENGINES

INSTALLATION

These instructions are provided as supplementary information to the factory service manual instructions for starter replacement.

DISCONNECT THE BATTERY.

MOUNT THE STARTER ON THE ENGINE. Make sure the mounting surface of the engine block is smooth, **flat and free of paint buildup**. Using the supplied bolts (**GM Only**), mount the starter and torque the starter mounting bolts to the engine manufacturer's specifications, typically 32 ft. lbs.

CHECK PINION ENGAGEMENT.

- 1.) Engage the pinion into the ring gear. This can be done by either:
 Using a tool to pull the pinion out of the starter OR
 Connecting 12 VDC to the "Switch" terminal only and reconnect the battery. (DO NOT connect battery cable to "BAT" terminal on the starter solenoid). This engages the solenoid and pinion but does not spin the starter. CAUTION: Do not leave the solenoid engaged in this manner for more than 30 seconds at a time as the solenoid will over-heat.
- 2.) Insert a wire gauge to check for proper backlash between the ring gear and starter pinion (see Figure 1). There should be a 0.020" to 0.025" clearance measured from the flank of a starter pinion tooth to the flank of a ring gear tooth. Check clearance at least six places on the ring gear. If the clearance is too small, add one shim at a time between the starter and engine block to bring it into specifications. In many installs, no shims are necessary.
- 3.) PLEASE NOTE: After releasing the solenoid, the pinion may stay engaged in the ring gear until the engine is started. This is normal for gear reduction starters and does NOT require shimming to correct.

DO NOT USE A JUMPER WIRE ON THE SOLENOID. STARTER WILL NOT DISENGAGE PROPERLY.

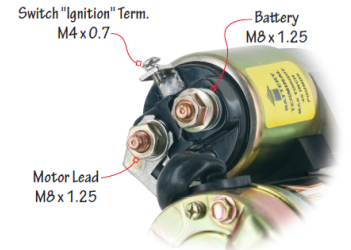
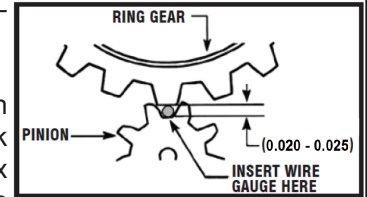

FIGURE 1



ATTACH BATTERY CABLE AND SWITCH WIRE. The switch wire should be capable of handling 50A intermittent and 10A continuous, typically a 12AWG wire. The battery cable must be the proper size for the length of the cable (see chart). All connections should be clean and tight and terminals should be soldered if possible. The ground cable is important and the best ground path is direct to the engine block. With steel frame vehicles the ground path can be to the frame. This ground cable should be the same size as the starter positive cable. Also, a ground strap should be installed from the frame to the engine.

CONNECT THE BATTERY.

DISTANCE	3'	5'	7'	10'	+10'
AWG	4	2	1	0	00

OPERATE THE STARTER. It should operate quietly. The cables and connectors themselves should be checked for voltage drop with a voltmeter. To check any wire or cable for voltage drop, connect one side of the voltmeter to one end of the cable and the other side of the voltmeter to the other end. OPERATE THE CIRCUIT and simultaneously measure the volt drop. It should be 0.5VDC or less. A high voltage drop indicates a bad connector or an undersized cable. The ground circuit can be checked in the same manner.

Measure input voltage by connecting the positive probe of a voltmeter to the "MOTOR" terminal of the solenoid and connecting the negative to the starter housing. This should be 10V minimum while cranking.

(cont'd on reverse)

CAUTION: NEVER OPERATE A STARTER MORE THAN 30 SECONDS AT A TIME WITHOUT ALLOWING TIME TO COOL AT LEAST TWO MINUTES. OVERCRANKING WILL DAMAGE THE STARTER.

COMMON QUESTIONS

1. WHY DOES THE ENGINE SEEM TO CRANK SLOWLY? Although this condition can be caused by several things, the most common cause is excessively low input voltage. The input voltage to the starter must be 10V volts or higher. Low voltage during cranking can be caused by undersized starter cables, high resistance or defective batteries, high resistance battery disconnect switches, or poor connectors.
2. WHAT DO I DO WITH THE WIRE THAT CONNECTED TO THE 'R' TERMINAL ON THE ORIGINAL STARTER? In early original wiring harnesses the 'R' circuit was a ballast resistor bypass. This terminal is 'no connection' when the starter is at rest and is +12VDC while cranking. This circuit provided +12VDC to the ignition coil during cranking for easier engine starting. Cars that do not have a ballast resistor (i.e. HEI, MSD or other aftermarket ignition systems) should not need this connection. In most cases this wire can be eliminated. If the engine has no ignition during cranking, then the wiring of the coil is going to require an 'R' terminal signal. To accomplish this, order **P/N 600 R-Terminal** kit or, connect a 10A/250V diode in line with the MOTOR SIDE of the solenoid. The cathode or banded end of the diode goes toward the starter. This allows current to go from the starter to the coil and not from the coil to the starter. Some Powermaster replacement solenoids are available with an 'R' terminal. Ask your dealer.

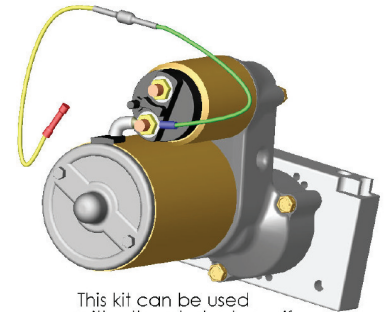

This kit can be used with other starter types if installed as shown above.

ADDITIONAL NOTES ON INSTALLATION

1. A NOTE ABOUT RING GEARS. It is important for long starter life that the ring gear be round and true. Check the ring gear in at least six places verifying that the clearance for the starter is the same in all locations. If not remove the ring gear and make sure the mounting surface of the crankshaft is clean and free of paint buildup or rust. Reinstall the ring gear and properly torque the mounting bolts. If this does not correct the problem, replace the ring gear.
2. DISCONNECT SWITCHES IN RACE CARS AND OTHER OFF ROAD VEHICLES. The switch used for a battery disconnect is very important. All of the starter current will go across this switch during cranking which, depending on the starter, can be as high as 700A. After the engine is running, all of the current from the alternator will be running across this switch. Therefore make sure that the switch that is being used can handle these amounts of current. Switches are rated in intermittent amps and continuous amps. The intermittent rating should match or exceed the amount the starter will pull and the continuous rating should match or exceed the amount the alternator can produce. Using a switch that is too small will result in voltage loss and possible switch failure.

INTERNAL SHIM FOR CLOCKABLE PowerMAX STARTERS

After the starter has been installed, there should be 1/16" (0.062) minimum between the engine side of the ring gear and the front edge of the teeth on the starter pinion gear. Check this distance with the ring gear in at least three different positions. If the distance is too little, a shim can be installed inside the starter, which will pull the pinion into the starter an additional 0.062". This will result in additional clearance between the pinion and the ring gear.

1. Remove the three socket head bolts that hold the aluminum mounting block to the starter-assembly.
2. Carefully remove the mounting block from the starter.
3. The round shaped shim should be installed between the mounting block and the starter body.
4. Align the holes in the block, the shim, and the starter. Reinstall and tighten the three socket head bolts.

