

USER'S MANUAL



P350MB

BLUETOOTH®
MP3-COMPATIBLE DIGITAL
MEDIA AM/FM RECEIVER



Planet Audio®

Installation

Installation Procedures

First complete the electrical connections and then check for correctness.

Installation Opening

This unit can be installed in any dashboard Having an opening as shown below.

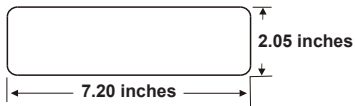

Insert mounting collar into the dashboard and bend the mounting tabs out with a screwdriver.

Make sure that lock lever is flush with the mounting collar(not projecting outward).

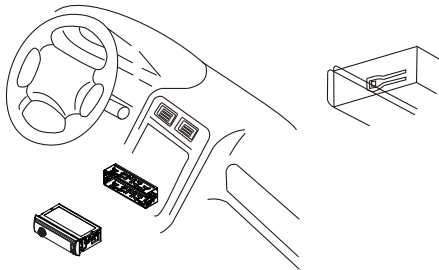
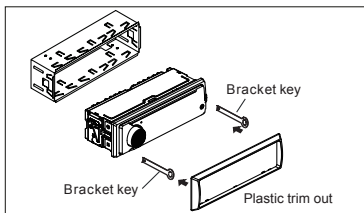

Installation

Connect all wiring harness and slide the head unit into the mounting collar until it clicks into place.

Wiring Connections

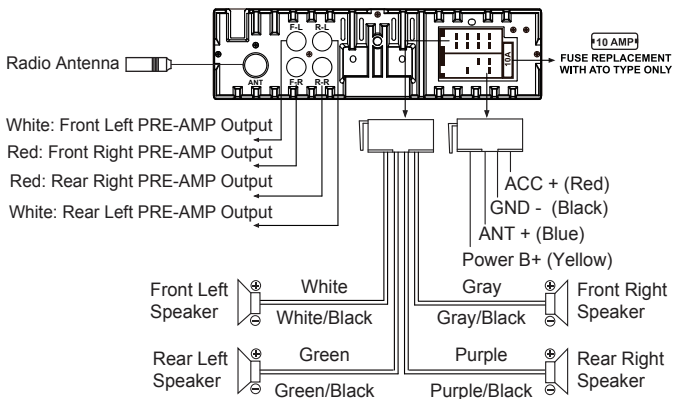

- +12V DC Negative Ground.
- Only use speakers with 4 ohms impedance.
- The maximum current of the Amp remote trigger is 200mA.

Overview of the Components

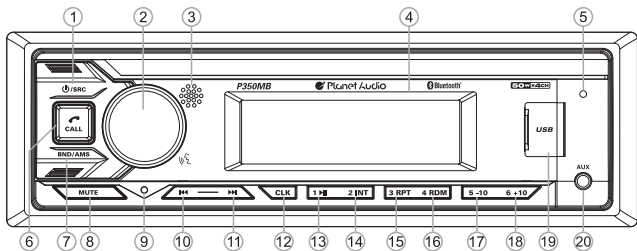

1. (power On/Off) / SRC (source) button
2. VOL (volume) knob, (Push-To-Talk) button and SEL (select/menu) button
3. IR remote sensor
4. LCD Display
5. Hands-free Microphone
6. (Answer Call / End Call) button
7. BAND button, AMS(automatic store, automatic music search) button
8. MUTE button
9. Reset button
10. (tune/seek down, previous track, fast reverse) button
11. (tune/ seek up, next track, fast forward) button
12. CLK(clock setting) button
13. (pause/play), Preset station 1 button
14. INT(intro), Preset station 2 button
15. RPT(repeat), Preset station 3 button
16. RDM (random), Preset station 4 button
17. -10(previous 10 tracks), previous folder, Preset station 5 button
18. +10(next 10 tracks), next folder, Preset station 6 button
19. USB Port
20. AUX IN (auxiliary input) jack

General Operation

Turn Unit on/off, Change the Source

- Press the /SRC button to turn on the unit. Press and hold the /SRC button to turn off the unit.
- Press the /SRC button to select the different modes: Radio, USB(with USB device inserted), AUX-IN(auxiliary input) and BT(Bluetooth) modes.

Adjust the volume (VOL)

Rotate the **VOL** knob to increase or decrease the volume level.

General Operation

Push-To-Talk

Press the  button (**VOL** knob) to access to smartphones voice assistant capability via Bluetooth.

Adjust Menu Options (SEL)

- Press and hold the **SEL** button to access the audio / function, then press the **SEL** button repeatedly to cycle through the following audio /function:
 - ILL MID/HI/LOW: This receiver is equipped with 3 brightness settings.
 - BASS/TREBLE:-7, -6, ~, 1, 0, +1,~, +6, +7
Note: BASS and TREBLE settings are only enabled when EQ setting is turned OFF.
 - BALANCE:L7, L6,~, L1, L=R, R1,~,R6, R7
 - FADER:R7, R6, ~, R1, 0, F1, ~ ,F6, F7
 - EQ(Equalizer) Setting: OFF, CLASS, ROCK, POP, FLAT
 - Loudness: LOUD ON/OFF
 - DX/LOCAL: Enables or disables the local broadcast mode (LOCAL).
 - Stereo/Mono: Switches between MONO and STEREO reception mode for radio frequencies.
 - CLOCK 12/24: Select between 12 hours and 24 hours display.
Note: If 12 hour display is selected , AM= Morning; PM= Afternoon
 - AREA US/EU: This car radio is equipped the USA / Europe frequency.
Rotate the **VOL** knob to switch between the USA and Europe frequency.
The system will change the frequency setting in about 3 seconds.
- Rotate the **VOL** knob to adjust the selected item.

Setting the Clock

Press the **CLK** button to display time. Press and hold the **CLK** button, the hours digits start flashing on the display. Set hours by rotating the **VOL** knob. Briefly press the **CLK** button. The minute digits start flashing. Set minutes by rotating the **VOL** knob. Finally press the **CLK** button to confirm your settings.

Mute On/Off

In power on mode, briefly press the **MUTE** button to toggle mute on or off.

USB Port

Auxiliary Input Jack

Reset

Push the **RESET** button with a thin object with a pointed end to reset all parameters to factory default settings. This function may be used when the LCD does not display normally or sound is distorted, or when any of controls are disabled.

Radio Operation

Switch Between USA area and Europe area Frequency

In radio mode, press and hold the **SEL** button to enter audio / function, then press the **SEL** button repeatedly to select the US (USA) and EU (europe) frequency, then rotate it to switch between US(USA) and EU(europe) frequency. The system will change the frequency setting in about 3 seconds.

Change Bands

In radio mode, shortly press the **BND/AMS** button to switch between the FM1(F1), FM2(F2), FM3(F3) and AM1(A1), AM2(A2) bands.

To Store / Recall Preset Stations

The radio can be stored 6 preset stations for each band (FM1, FM2, FM3, AM1 and AM2) for atotal of 30 preset stations.

- To memorize a station:

Press and hold the desired preset buttons (1-6) to save a radio station.

- To recall a preset station:

Briefly press the respective station button (1-6) to recall the corresponding preset station.

Manual Tuning

In the radio mode:

Press and hold the **▶▶** or **◀◀** button to enter the manual tuning mode.

In manual tuning mode, briefly press the **▶▶** or **◀◀** button to search the next or previous frequency step by step.

Seek Tuning

In radio mode, press the **▶▶** or **◀◀** button, the automatic search will start, it will search upward or downward for the strong signal radio station within the curret band. The auto searching will stop until find a station.

Automatic Store Station / preset station scan (Q)

Press and hold the **BND/AMS** button to store 18 FM stations and 12 AM stations automatically.

USB Operation

To play files on a USB device, insert a USB storage device into the USB port. The MP3/WMA files will be played automatically.

Note: The USB port of this car radio is also designed for charging for iPhone / android mobile phone. The charging current consumption is 1 ampere.

Select Next Track or Previous Track

In the USB mode, briefly press the **▶▶** or **◀◀** button to play the the next or previous track.

Fast Forward/Reverse

Press and hold the **▶▶** or **◀◀** button to fast forward or reverse a track.

Play / Pause

Press the **▶||** button to interrupt the playback of a music (pause function). Press this button again to continue the playback.

Introduction Scan

Press the **INT** button to play the first 10 seconds of all track.

Press again to stop the introduction scan, and play the current track.

Repeating the track

Press the **RPT** button to toggle between RPT ALL (Play all track), RPT FLR (Continuously repeat all tracks in current folder) and RPT ONE (Continuously repeat current track).

Playing all tracks in random

Press **RDM** once, play all tracks randomly.

Press **RDM** once again, exit from random playback.

Track/Folder Navigation

- Press the **-10/+10** buttons to jump 10 tracks backward or forward.

It is required that over 10 tracks be available on the storage medium.

- Press and hold the **-10/+10** button to select the previous or the next folder. (If there are folders on the storage medium.)

Select the track or file for playback in MP3 format

a) Press and hold the **BND/AMS** button to enter track search mode. First "TRK0000" will appear on the display.

b) Rotate the volume knob and select the "first number". Then press the **◀◀** button to move the "first number" to the left and enter the next number.

c) When the desired track number appears, confirm your selection by pressing **SEL** button.

If no any operation in 5 seconds, it will play the current track.

Auxiliary Operation

Using this socket, it is possible to hear the sound of other playback devices such as MP3 players, CD players etc. through the car loudspeaker.

1. Please connect the external device with a 3.5 mm stereo jack plug to the AUX socket.
2. Press the **SRC** button repeatedly until "AUX IN" appears in the display.
3. You hear the playback from the external device via the loudspeakers. You can adjust the volume of the external device to a comfortable level with the volume control of this device.

Bluetooth Operation

Pair and Connect

Pair the mobile phone with the device before using it.

1. In any mode, prior to pairing and connecting, the BT symbol flashes that stands for no Bluetooth device connected. To begin pairing, enable BT mode on your mobile phone.
2. When the phone finds the car audio system, the "PLANET AUDIO P350MB" name will be displayed.
3. Choose the "PLANET AUDIO P350MB" from the device list to pair and connect with the car audio system. Upon confirming, the BT logo will stop flashing.
4. When pairing is complete, the mobile phone audio will automatically transfer to the car audio system whenever a call is made or received, or



Make a Call

To make a call, dial the call directly from the paired mobile phone.



Redial Last Dialed Number

Press and hold the  button on the control panel to redial the last dialed phone number.

Answer a Call

- When the mobile phone is called, the incoming telephone number displays on the LCD.
- To receive the call, press the  button on the front panel or  button on the remote control.

Reject or End a Call

To reject or end the call, the  button on the front panel or  button on the remote control.

Bluetooth Operation

Switch Audio Between Car Audio and mobile Phone

During a call, press the **VOL** knob/button to switch the audio source from the car audio system back to your mobile phone.

Adjust Call Volume

During a call, use **VOL** knob to adjust the call volume level.

Audio Streaming (A2DP)

The unit supports A2DP (advanced audio distribution profile) wireless streaming audio from your Bluetooth mobile device directly to your head unit. You can also control your music from the front panel of the head unit using AVRCP (audio video remote control profile).

1. After pairing, connecting and enabling streaming audio from a compatible mobile device, press the **SRC** button to enter BT mode and the "BT AUDIO" will be shown on the LCD display.
2. When a mobile device is paired, music played through that device will automatically be heard through the car audio system and display A2DP in the LCD display.
3. Press the **▶▶** or **◀◀** button to play the next or previous on the mobile phone.
4. Press the **▶||** button to pause or resume music playback.

Push-To-Talk

This Push-To-Talk feature allows direct access to Android and IOS smartphones voice assistant capability when user establish the bluetooth connection between user's smartphone and this receiver. Simply connect directly from this receiver via Bluetooth with  button.

Note:

Before using the Push-To-Talk, user must enable the mobile data on user's smartphone.

To use the navigation feature, switch to the BT Audio source to hear voice commands over your vehicles speakers.

Remote Control

1.  (Power on/off) button
2. VOL+/VOL-(volume increase/decrease) button
3. Band button,  (answer call) button
4. PREV: tune down, seek down;
Track down, fast reverse
5. SEL(selection) button
6. NEXT: tune up, seek up;
Track up, fast forward
7. Mute button, DEL(Delete) button
8. CLK(clock setting) button,  (end call) button
9.  button, preset station 1 button, keypad 1
10. INT(intro) button, preset station 2 button, keypad 2
11. RPT(repeat) button, preset station 3 button, keypad 3
12. RDM(random), preset station 4 button, keypad 4
13. -10(previous 10 tracks), preset station 5 button, keypad 5
14. +10(next 10 tracks), preset station 6 button, keypad 6
15. ST(stereo) button, keypad 7
16. LOUD(loudness) button, keypad 8
17. AMS(automatic music search) button, keypad 9
18. SRC(Source) button, keypad *
19. EQ(Equalizer) button, keypad 0
20. LOC(local)/DX button, keypad #

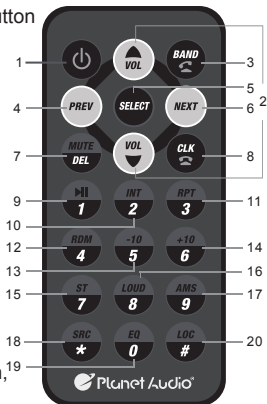

Note: When using the remote control for the first time, you must pull out the protective plastic tab from the battery compartment found on the back of the remote control.

Specifications

General

Power supply Requirement :	DC 12V
Maximum power output :	50W X 4CH
Speaker impedance :	4 - 8 Ohm
Unit Dimensions(WxHxD) :	7.0 X 2.0 X 2.76 inches
Weight :	1.04 lbs
Fuse :	10 A

RADIO

FM

Frequency Range:	87.5 MHz - 107.9 MHz (USA) 87.5 MHz - 108.0MHz (EUROPE)
Channel step:	200 KHz(USA) 50 KHz(EUROPE)

AM

Frequency Range:	530 KHz - 1710 KHz (USA) 522-1620 KHz(EUROPE)
Channel step:	10 KHz(USA) 9 KHz(EUROPE)

USB

Usable Audio Formats:	MP3/WMA
USB Port Type:	2.0
USB Charging:	5V/1A
Pre-amp Output:	Front and Rear
Frequency Response:	20 Hz - 20KHz
S/N Ratio:	60dB

BT

BT Profile supports:	Headset, Handsfree and A2DP & AVRCP
Range of frequency:	2.4GHz