

Pioneer

**AVH-X7800BT
AVH-X6800DVD**

DVD RDS AV RECEIVER

 **Important (Serial number)**

The serial number is located on the bottom of this unit. For your own security and convenience, be sure to record this number on the enclosed warranty card.

WORKS WITH
PANDORA

Owner's Manual

Contents

Thank you for buying this Pioneer product. Please read through these instructions so you will know how to operate your model properly. After you have finished reading the instructions, keep this document in a safe place for future reference.

Important

The screens shown in the examples may differ from actual screens, which may be changed without notice for performance and function improvements.

Precaution.....4

Information to User.....	4
License, Warranty Disclaimer & Limitation of Liability.....	5
Important safety information.....	5
Parking brake interlock.....	5
When using a display connected to rear monitor output.....	6
To avoid battery exhaustion.....	6
Rear view camera.....	6
Handling the USB connector.....	6
Failure to operate.....	6
Visit our website.....	6
Protecting the LCD panel and screen.....	6
Notes on internal memory.....	6
About this manual.....	7
Protecting your unit from theft.....	7
Use and care of the remote control.....	7

Basic operation.....8

Checking part names and functions.....	8
Remote control.....	8
Notes on using the LCD panel.....	9
Opening and closing the LCD panel.....	9
Turning the LCD panel horizontally.....	9
Adjusting the LCD panel slide position.....	9
Adjusting the LCD panel angle.....	10
Inserting/ejecting/connecting media.....	10
On first-time startup.....	10
How to use the screens.....	12
Supported AV source.....	13
Displaying the AV operation screen.....	13
Selecting a source.....	13

Changing the display order of sources.....	13
Using the touch panel.....	13

Registration and connection of Bluetooth® device.....14

Displaying the "Bluetooth" screen.....	14
Registering your Bluetooth devices.....	14
Connecting a registered Bluetooth device manually.....	14
Switching visibility.....	15
Entering the PIN code for Bluetooth wireless connection.....	15
Displaying the device information.....	15
Clearing the Bluetooth memory.....	15
Updating Bluetooth software.....	15
Displaying the Bluetooth software version.....	15
Switching the connected Bluetooth device.....	15

Hands-free phoning.....16

Displaying the Phone menu screen.....	16
Making a phone call.....	16
Receiving a phone call.....	17
Minimizing the dial confirmation screen.....	17
Changing the phone settings.....	17
Using the voice recognition function (for iPhone).....	17
Setting phone book auto synchronization.....	17
Notes for hands-free phoning.....	18

Setup for iPod / iPhone or smartphone.....18

The basic flow of iPod / iPhone or smartphone setup.....	18
Setting the device connection method.....	18
iPod compatibility.....	19
Android™ device compatibility.....	19
Information on the connections and functions for each device.....	20

Radio.....21

Starting procedure.....	21
Storing the strongest broadcast frequencies.....	21
Tuning into strong frequencies.....	21

Disc.....22

Starting procedure.....	23
Selecting files from the file name list.....	23

Switching the media file type.....	23
Searching for the part you want to play.....	23
Operating the DVD menu.....	23
Switching the subtitle/audio language.....	23
Operating the DVD menu using touch panel keys.....	23

Compressed files.....24

Starting procedure (for Disc).....	26
Starting procedure (for USB).....	26
Operations common to all file types.....	26
Audio file operations.....	26
Still image file operations.....	27

iPod.....27

Connecting your iPod.....	28
Starting procedure.....	28
Selecting song or video sources from the playlist screen.....	28
Using this product's iPod function from your iPod.....	29
Selecting a song from the list related to the song currently playing (link search).....	29

AppRadioOne.....29

Using AppRadioOne.....	29
Using the audio mix function.....	30

Pandora®.....30

Pandora operations.....	31
Starting procedure.....	31
Selecting a Pandora station from the list.....	31
Adding a station.....	31
Storing the preset stations.....	32

Spotify®.....32

Using Spotify with your Pioneer car audio/video.....	33
Starting procedure.....	33
Selecting a track or station from the list.....	34

Bluetooth audio player.....34

Starting procedure.....	34
Selecting files from the file name list.....	35

AUX source.....35

Starting procedure.....	35
Setting the video signal.....	35

AV input.....36

Starting procedure.....	36
Setting the video signal.....	36

MIXTRAX.....36

MIXTRAX operation.....	36
MIXTRAX EZ operation.....	36
Displaying the "MIXTRAX Settings" screen.....	37
Setting the flash pattern.....	37

System settings.....37

Displaying the "System" setting screen.....	37
Setting Bluetooth audio source activation.....	37
Setting Spotify source activation.....	37
Setting the ever scroll.....	37
Setting the beep tone.....	38
Setting the auto audio mix function.....	38
Setting the rear view camera.....	38
Setting the demo mode.....	38
Selecting the system language.....	38
Setting the keyboard language with the application for iPhone.....	38
Adjusting the response positions of the touch panel (touch panel calibration).....	38
Setting the dimmer.....	39
Adjusting the picture.....	39
Displaying the firmware version.....	40
Displaying the open source licenses.....	40
Updating firmware.....	40

Audio adjustments.....40

Displaying the "Audio" setting screen.....	40
Using fader/balance adjustment.....	40
Switching sound muting/attenuation.....	40
Adjusting source levels.....	41
Using the auto level control.....	41
Adjusting loudness.....	41
Setting the subwoofer output.....	41
Adjusting the cutoff frequency value.....	41
Switching the rear speaker output.....	41
Using BASS Boost.....	41
Selecting the listening position.....	41
Adjusting the speaker output levels finely.....	42
Adjusting the time alignment.....	42
Switching the time alignment preset.....	42
Using the equalizer.....	42
Adjusting the equalizer curve automatically (Auto EQ).....	43
Saving the sound settings.....	44

Contents

Loading the sound settings	44	iPhone with Lightning connector	52
■ Theme menu	44	iPhone with 30-pin connector	52
Selecting the background display	44	Android device	52
Setting the illumination color	44	Camera	52
Selecting the theme color	45	External video component and the display	53
Selecting the clock image	45	■ Installation	54
■ Setting up the video player	45	Precautions before installation	54
Setting the top-priority languages	45	Before installing	54
Setting the angle icon display	45	Installation notes	54
Setting the aspect ratio	45	DIN front/rear-mount	54
Setting parental lock	46	Installing the microphone	55
Displaying your DivX VOD registration code	46	Mounting on the sun visor	55
Displaying your DivX VOD deregistration code	46	Installation on the steering column	56
Automatic playback of DVDs	46	Adjusting the microphone angle	56
Setting the video signal for the rear view camera	46	■ Appendix	56
■ Favorite menu	47	Troubleshooting	56
Creating a shortcut	47	Error messages	57
Selecting a shortcut	47	Handling and care of discs	59
Removing a shortcut	47	Playable discs	59
■ Common operations	47	Detailed information for playable media	60
Setting the time and date	48	Bluetooth	62
Storing song information to an iPod (iTunes Tagging)	48	WMA	63
Setting the "Sound Retriever" function	48	FLAC	63
Changing the wide screen mode	48	DivX	63
■ Other functions	49	AAC	63
Restoring this product to the default settings	49	Android™	63
■ Connection	49	Detailed information regarding connected iPod devices	63
Precautions	49	Using app-based connected content	64
Precautions before connecting the system	49	Pandora®	64
Before installing this product	49	Spotify®	64
To prevent damage	49	Notice regarding video viewing	64
Notice for the blue/white lead	50	Notice regarding DVD-Video viewing	64
This product	50	Notice regarding MP3 file usage	64
Power cord	50	Using the LCD screen correctly	64
Speaker leads	51	Specifications	65
Power amp (sold separately)	51		
iPhone and smartphone	52		

Precaution

Information to User

- MODEL NO. : AVH-X7800BT
Contains FCC ID : AJDK071
Contains/Contient IC : 775E-K071
- This device complies with Part 15 of FCC Rules and Industry Canada licence-exempt RSS standard(s).
Operation is subject to the following two conditions: (1) this device may not cause interference, and (2) this device must accept any interference, including interference that may cause undesired operation of this device.
- The Bluetooth antenna cannot be removed (or replaced) by user.
- This equipment complies with FCC/IC radiation exposure limits set forth for an uncontrolled environment and meets the FCC radio frequency (RF) Exposure Guidelines and RSS-102 of the IC radio frequency (RF) Exposure rules. This equipment has very low levels of RF energy that it deemed to comply without maximum permissive exposure evaluation (MPE). But it is desirable that it should be installed and operated keeping the radiator at least 20 cm or more away from person's body (excluding extremities: hands, wrists, feet and ankles).

MODEL NO. : AVH-X6800DVD
This device complies with Part 15 of the FCC Rules.
Operation is subject to the following two conditions:
(1) this device may not cause harmful interference, and (2) this device must accept any interference received, including interference that may cause undesired operation.

- This transmitter must not be co-located or operated in conjunction with any other antenna or transmitter.
- Alteration or modifications carried out without appropriate authorization may invalidate the user's right to operate the equipment.
- NOTE: This equipment has been tested and found to comply with the limits for a Class B digital device, pursuant to Part 15 of the FCC Rules. These limits are designed to provide reasonable protection against harmful interference in a residential installation. This equipment generates, uses and can radiate radio frequency energy and, if not installed and used in accordance with the instructions, may cause harmful interference to radio communications. However, there is no guarantee that interference will not occur in a particular installation. If this equipment does cause harmful interference to radio or television reception, which can be determined by turning the equipment off and on, the user is encouraged to try to correct the interference by one or more of the following measures:
 - Reorient or relocate the receiving antenna.
 - Increase the separation between the equipment and receiver.
 - Connect the equipment into an outlet on a circuit different from that to which the receiver is connected.
 - Consult the dealer or an experienced radio/TV technician for help.

CAUTION:
USE OF CONTROL OR ADJUSTMENT OR PERFORMANCE OF PROCEDURES OTHER THAN THOSE SPECIFIED HEREIN MAY RESULT IN HAZARDOUS RADIATION EXPOSURE.
CAUTION:
THE USE OF OPTICAL INSTRUMENTS WITH THIS PRODUCT WILL INCREASE EYE HAZARD.

CAUTION

This product is a Class 1 laser product classified under the Safety of laser products, IEC 60825-1:2007, and contains a class 1M laser module. To ensure continued safety, do not remove any covers or attempt to gain access to the inside of the product. Refer all servicing to qualified personnel.

CLASS 1 LASER PRODUCT

CAUTION—CLASS 1M VISIBLE AND INVISIBLE LASER RADIATION WHEN OPEN, DO NOT VIEW DIRECTLY WITH OPTICAL INSTRUMENTS.

⚠WARNING

This product contains chemicals known to the State of California and other governmental entities to cause cancer and birth defects or other reproductive harm. **Wash hands after handling.**

The Safety of Your Ears is in Your Hands

Get the most out of your equipment by playing it at a safe level—a level that lets the sound come through clearly without annoying blaring or distortion and, most importantly, without affecting your sensitive hearing. Sound can be deceiving. Over time, your hearing "comfort level" adapts to higher volumes of sound, so what sounds "normal" can actually be loud and harmful to your hearing. Guard against this by setting your equipment at a safe level BEFORE your hearing adapts.

ESTABLISH A SAFE LEVEL:

- Set your volume control at a low setting.
- Slowly increase the sound until you can hear it comfortably and clearly, without distortion.
- Once you have established a comfortable sound level, set the dial and leave it there.

Precaution

BE SURE TO OBSERVE THE FOLLOWING GUIDELINES:

- Do not turn up the volume so high that you can't hear what's around you.
- Use caution or temporarily discontinue use in potentially hazardous situations.
- Do not use headphones while operating a motorized vehicle; the use of headphones may create a traffic hazard and is illegal in many areas.

License, Warranty Disclaimer & Limitation of Liability

SAFETY PROVISIONS

Disclaimer

THE WARRANTIES SET FORTH IN PIONEER'S LIMITED WARRANTY ARE THE ONLY WARRANTIES MADE BY PIONEER OR ANY OF ITS LICENSORS, AS APPLICABLE. PIONEER AND ITS LICENSORS EXPRESSLY DISCLAIM ALL OTHER WARRANTIES, EXPRESS OR IMPLIED, INCLUDING, WITHOUT LIMITATION, WARRANTIES OF MERCHANTABILITY AND FITNESS FOR A PARTICULAR PURPOSE.

Limitation of Liability

TO THE MAXIMUM EXTENT PERMISSIBLE UNDER APPLICABLE LAW, NEITHER PIONEER NOR ITS LICENSORS WILL BE LIABLE TO YOU OR TO ANY OTHER PARTY FOR ANY INDIRECT, CONSEQUENTIAL, INCIDENTAL, PUNITIVE, OR SPECIAL DAMAGES, REGARDLESS OF THE FORM OF ACTION, WHETHER IN CONTRACT OR IN TORT, INCLUDING NEGLIGENCE, EVEN IF SUCH PARTIES HAVE BEEN ADVISED OF THE POSSIBILITY OF SUCH DAMAGES. TO THE MAXIMUM EXTENT PERMISSIBLE UNDER APPLICABLE LAW, PIONEER'S, OR ITS LICENSORS', TOTAL LIABILITY OF ANY KIND ARISING OUT OF OR RELATED TO YOUR USE OF THE PRODUCTS, INCLUDING, BUT NOT LIMITED TO, ANY WARRANTY CLAIMS, OR ANY CLAIMS FOR PROPERTY DAMAGE, DEATH OR DISABILITY, REGARDLESS OF THE FORUM AND REGARDLESS OF WHETHER ANY ACTION OR CLAIM IS BASED ON CONTRACT, TORT, (INCLUDING NEGLIGENCE), STRICT PRODUCT LIABILITY, OR ANY OTHER LEGAL THEORY

SOME JURISDICTIONS DO NOT ALLOW THE EXCLUSION OF DAMAGES OR LIMITATION OF LIABILITY, SO THE ABOVE EXCLUSIONS OR LIMITATIONS, TO THE EXTENT PROHIBITED BY APPLICABLE LAW, MAY NOT APPLY TO YOU. YOUR SPECIFIC RIGHTS MAY VARY FROM JURISDICTION TO JURISDICTION.

Important safety information

⚠️WARNING

- Do not attempt to install or service this product by yourself. Installation or servicing of this product by persons without training and experience in electronic equipment and automotive accessories may be dangerous and could expose you to the risk of electric shock, injury or other hazards.
 - Do not allow this product to come into contact with liquids. Electrical shock could result. Also, damage to the product, smoke, and overheating could result from contact with liquids.
 - If liquid or foreign matter should get inside this product, park your vehicle in a safe place, turn the ignition switch off (ACC OFF) immediately and consult your dealer or the nearest authorized Pioneer Service Station. Do not use this product in this condition because doing so may result in a fire, electric shock, or other failure.
 - If you notice smoke, a strange noise or odor from this product, or any other abnormal signs on the LCD screen, turn off the power immediately and consult your dealer or the nearest authorized Pioneer Service Station. Using this product in this condition may result in permanent damage to the system.
 - Do not disassemble or modify this product, as there are high-voltage components inside which may cause an electric shock. Be sure to consult your dealer or the nearest authorized Pioneer Service Station for internal inspection, adjustments or repairs.
- Before using this product, be sure to read and fully understand the following safety information:
- Do not operate this product, any applications, or the rear view camera option (if purchased) if doing so will divert your attention in any way from the safe operation of your vehicle. Always observe safe driving rules and follow all existing traffic regulations. If you experience difficulty in operating this product or reading the display, park your vehicle in a safe location and apply the parking brake before making the necessary adjustments.
 - Never set the volume of this product so high that you cannot hear outside traffic and emergency vehicles.

- To promote safety, certain functions are disabled unless the vehicle is stopped and/or the parking brake is applied.
- Keep this manual handy as a reference for operating procedures and safety information.
- Do not install this product where it may (i) obstruct the driver's vision, (ii) impair the performance of any of the vehicle's operating systems or safety features, including air bags or hazard lamp buttons or (iii) impair the driver's ability to safely operate the vehicle.
- Please remember to fasten your seat belt at all times while operating your vehicle. If you are ever in an accident, your injuries can be considerably more severe if your seat belt is not properly buckled.
- Never use headphones while driving.

Parking brake interlock

Certain functions (such as viewing of video image and certain touch panel key operations) offered by this product could be dangerous (possibly resulting in serious injury or death) and/or unlawful if used while driving. To prevent such functions from being used while the vehicle is in motion, there is an interlock system that senses when the parking brake is set and when the vehicle is moving. If you attempt to use the functions described above while driving, they will become disabled until you stop the vehicle in a safe place, and (1) apply the parking brake, (2) release the parking brake, and then (3) apply the parking brake again. Please keep the brake pedal pushed down before releasing the parking brake.

To ensure safe driving

⚠️WARNING

- **LIGHT GREEN LEAD AT POWER CONNECTOR IS DESIGNED TO DETECT PARKED STATUS AND MUST BE CONNECTED TO THE POWER SUPPLY SIDE OF THE PARKING BRAKE SWITCH. IMPROPER CONNECTION OR USE OF THIS LEAD MAY VIOLATE APPLICABLE LAW AND MAY RESULT IN SERIOUS INJURY OR DAMAGE.**
- **Do not take any steps to tamper with or disable the parking brake interlock system which is in place for your protection. Tampering with or disabling the parking brake interlock system could result in serious injury or death.**
- **To avoid the risk of damage and injury and the potential violation of applicable laws, this product is not for use with a video image that is visible to the driver.**

Precaution

- In some countries the viewing of video image on a display inside a vehicle even by persons other than the driver may be illegal. Where such regulations apply, they must be obeyed.

If you attempt to watch video image while driving, the warning **"Viewing of front seat video source while driving is strictly prohibited."** will appear on the screen. To watch video image on this display, stop the vehicle in a safe place and apply the parking brake. Please keep the brake pedal pushed down before releasing the parking brake.

When using a display connected to rear monitor output

The video output terminal (**rear monitor output**) is for connection of a display to enable passengers in the rear seats to watch video images.

⚠WARNING

NEVER install the rear display in a location that enables the driver to watch video images while driving.

To avoid battery exhaustion

Be sure to run the vehicle engine while using this product. Using this product without running the engine can drain the battery.

⚠WARNING

Do not install this product in a vehicle that does not have an ACC wire or circuitry available.

Rear view camera

With an optional rear view camera, you are able to use this product as an aid to keep an eye on trailers, or backing into a tight parking spot.

⚠WARNING

- SCREEN IMAGE MAY APPEAR REVERSED.
- USE INPUT ONLY FOR REVERSE OR MIRROR IMAGE REAR VIEW CAMERA. OTHER USE MAY RESULT IN INJURY OR DAMAGE.

⚠CAUTION

The rear view mode is to use this product as an aid to keep an eye on the trailers, or while backing up. Do not use this function for entertainment purposes.

Handling the USB connector

⚠CAUTION

- To prevent data loss and damage to the storage device, never remove it from this product while data is being transferred.
- Pioneer cannot guarantee compatibility with all USB mass storage devices and assumes no responsibility for any loss of data on media players, iPhone, smartphone, or other devices while using this product.

Protecting the LCD panel and screen

- Do not expose the LCD screen to direct sunlight when this product is not used. This may result in LCD screen malfunction due to the resulting high temperatures.
- When using a cellular phone, keep the antenna of the cellular phone away from the LCD screen to prevent disruption of the video in the form of spots, colored stripes, etc.
- To protect the LCD screen from damage, be sure to touch the touch panel keys only with your finger and do so gently.

Notes on internal memory

Before removing the vehicle battery

- Some of the settings and recorded contents will not be reset.

Data subject to erasure

The information is erased by disconnecting the yellow lead from the battery (or removing the battery itself).

- Some of the settings and recorded contents will not be reset.

Resetting the microprocessor

⚠CAUTION

Pressing the **RESET** button resets settings and recorded contents to the factory settings.

- Do not perform this operation when a device is connected to this product.
- Some of the settings and recorded contents will not be reset.

The microprocessor must be reset under the following conditions:

- Prior to using this product for the first time after installation.
- If this product fails to operate properly.
- If there appears to be problems with the operation of the system.
- If your vehicle position is shown on the map with a significant positioning error.

1 Turn the ignition switch OFF.

2 Press the RESET button with a pen tip or other pointed implement.





Precaution

☞ Refer to *Checking part names and functions* on page 8. Settings and recorded contents are reset to the factory settings.

About this manual

This manual uses diagrams of actual screens to describe operations. However, the screens on some units may not match those shown in this manual depending on the model used.

Meanings of Symbols Used in This Manual

	This indicates model name that are supported the described operations.
	This indicates to touch an appropriate soft key on the touch screen.
	This indicates to touch and hold an appropriate soft key on the touch screen.
	This indicates that there is a reference or supplementary for the key or screen.

Protecting your unit from theft

The front panel can be detached to deter theft.

Important

- Handle the front panel with care when removing or attaching it.
- Avoid subjecting the front panel to excessive shock.
- Keep the front panel out of direct sunlight and high temperatures.
- If removed, replace the front panel on the unit before starting up your vehicle.
- To avoid damaging the device or vehicle interior, remove any cables and devices attached to the front panel before detaching it.

Removing the front panel

- 1 **Pinch the top and bottom of its right side and pull the front panel out.**

Take care not pinch it too tightly or to drop it, and also avoid contact with water or other fluids to prevent permanent damage.

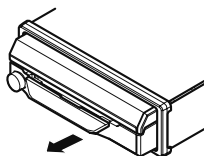

Re-attaching the front panel

1 Slide the front panel to the left.

The front panel and the head unit are connected on the left side. Make sure that the front panel has been properly connected to the head unit.

2 Press the right side of the front panel until it is firmly seated.

If you can't attach the front panel to the head unit successfully, try again. Forcing the front panel into place may result in damage.

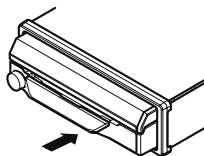

Use and care of the remote control

Installing the battery

Slide the tray on the back of the remote control out and insert the battery with the plus (+) and minus (-) poles aligned properly.

- When using for the first time, pull out the film protruding from the tray.

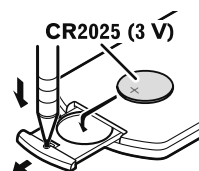

WARNING

- Do not ingest the battery, Chemical Burn Hazard.
- This product, including the supplied remote control, contains a coin/button cell battery. If the coin/button cell battery is swallowed, it can cause severe internal burns in just two hours and can lead to death.
- Keep new or used batteries out of the reach of children. If the battery is swallowed or placed inside any part of the body, consult a doctor immediately.
- If the battery compartment does not close securely, stop using the product and keep it away from children.
- Batteries (battery pack or batteries installed) must not be exposed to excessive heat such as sunshine, fire or the like.

CAUTION

- Remove the battery if the remote control is not used for a month or longer.
- There is a danger of explosion if the battery is incorrectly replaced. Replace only with the same or equivalent type.
- Do not handle the battery with metallic tools.
- Do not store the battery with metallic objects.
- If the battery leaks, wipe the remote control completely clean and install a new battery.
- When disposing of used batteries, comply with governmental regulations or environmental public institutions' rules that apply in your country/area.
- *Perchlorate Material – special handling may apply.

Using the remote control

Point the remote control in the direction of the front panel to operate.

- The remote control may not function properly in direct sunlight.

Precaution

Important

- Do not store the remote control in high temperatures or direct sunlight.
- Do not let the remote control fall onto the floor, where it may become jammed under the brake or gas pedal.

Basic operation

Checking part names and functions

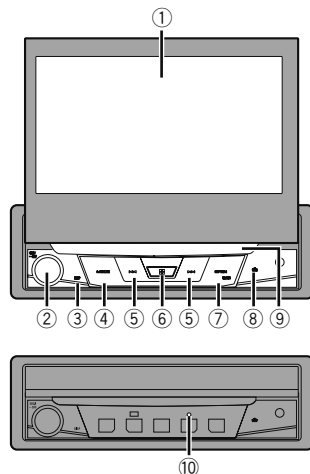

1	LCD screen	
2	Volume/SRC/OFF	Press to cycle through all the available sources. On the Application screen or navigation mode, press to display the side control bar. Press and hold to turn the display off. Press and hold to turn the source off.
3	DISP button	On the AV operation screen, press to turn the display off. On the Application screen or navigation mode, press to display the side control bar. Press and hold to turn the display off. <input type="checkbox"/> When the display is turned off, touch the screen to revert to the original screen.
4	MODE button	Press to switch between the Application screen and the AV operation screen. Press and hold to switch to the camera view mode.

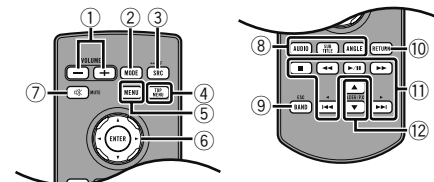

5	TRK (◀▶) button	Press to return to the previous track (chapter) or go to the next track (chapter). Press and hold to perform fast reverse or fast forward. Press to answer or end a call.
6	☰ button	Press to display the top menu screen. Press and hold to activate the voice recognition function. ☞ Refer to <i>Using the voice recognition function (for iPhone)</i> on page 17
7	OPEN/CLOSE button	Press OPEN/CLOSE to open the LCD panel. To close the LCD panel, press OPEN/CLOSE again.
8	▲ button	
9	Disc-loading slot	☞ Refer to <i>Inserting and ejecting a disc</i> on page 10
10	RESET button	☞ Refer to <i>Resetting the microprocessor</i> on page 6

Remote control



1	Volume (+/-)	
2	MODE	Press to switch between the Application screen and the AV operation screen. Press and hold to switch to the camera view mode.
3	SRC	Press to cycle through all the available sources. Press and hold to turn the source off.
4	TOP MENU	Returns to the top menu during DVD playback.
5	MENU	Displays the DVD menu during DVD playback.
6	Thumb pad	Selects a menu on the DVD menu.
7	MUTE	

Basic operation

8	AUDIO SUBTITLE ANGLE	Changes the audio language, subtitle language or viewing angle during DVD playback.
9	BAND/ ESC	Selects the tuner band when tuner is selected as a source. Cancels the control mode of functions. Switches between media file types when playing the data of Disc, USB.
10	RETURN	Returns to the specified point and begins playback from there.
11	 or 	For audio: Press and hold to perform fast reverse or fast forward. For video: Press to perform fast reverse or fast forward.
		Press to return to the previous track (chapter) or go to the next track (chapter). Press to answer or end a call.
		Stops playback. If you resume playback, playback will start from the point where you stopped. Touch the key again to stop playback completely.
12	FOLDER/P. CH	Selects the next or previous disc or folder. Recalls radio station frequencies assigned to preset channel keys.

Notes on using the LCD panel

⚠WARNING

- Keep hands and fingers clear of this product when opening, closing, or adjusting the LCD panel. Be especially cautious of children's hands and fingers.
- Do not use with the LCD panel left open. It may result in injury in the event of an accident.

⚠CAUTION

- Do not open or close the LCD panel by force. It may cause a malfunction.
- Do not operate this product until the LCD panel has completely opened or closed. The LCD panel may stop at that angle for safety.
- Do not place a glass or can on the open LCD panel.

Opening and closing the LCD panel

The LCD panel will open or close automatically when the ignition switch is turned on or off. You can turn off the automatic close/open function.

- Do not close the LCD panel by force with your hands. That will cause a malfunction.
 - The automatic close/open function will operate the display as follows.
 - When the ignition switch is turned OFF while the LCD panel is opened, the LCD panel will close after six seconds.
 - When the ignition switch is turned ON again (or turned to ACC), the LCD panel will open automatically.
 - Removing or attaching the front panel will automatically close or open the LCD panel.
- ⇒ *Protecting your unit from theft on page 7*
- When the ignition switch is turned OFF after the LCD panel has been closed, turning the ignition switch ON again (or turning it to ACC) will not open the LCD panel. In this case, press **OPEN/CLOSE** to open the LCD panel.
 - When closing the LCD panel, check to make sure that it has closed completely. If the LCD panel has stopped halfway, leaving it like this could result in damage.

1 Press OPEN/CLOSE to open the LCD panel.

- To close the LCD panel, press **OPEN/CLOSE** again.

Setting the automatic open function

To prevent the display from hitting the shift lever of an automatic vehicle when it is in the **P** (park) position, or when you do not wish the display to open/close automatically, you can set the automatic open function to manual mode.

1 Display the "System" setting screen.



2 Touch [Auto Flap].

- **On** (default): The LCD panel will open or close automatically when the ignition switch is turned on or off.
- **Off**: You have to press **OPEN/CLOSE** to open/close the LCD panel.

Turning the LCD panel horizontally

When the LCD panel is upright and hinders the operation of the air conditioner, the panel can be turned horizontally temporarily.

1 Press and hold OPEN/CLOSE to display the flap menu.

2 Touch the flip down temporarily key to flip the LCD panel down to the horizontal position.



Flips the LCD panel down to the horizontal position temporarily.

- To return to the original position, press and hold **OPEN/CLOSE**.
- The LCD panel returns to the original position automatically, indicated with a beeping sound 10 seconds after operation.

Adjusting the LCD panel slide position

You can adjust the LCD panel slide position so that the panel is set back or forward.

1 Press and hold OPEN/CLOSE to display the flap menu.

2 Touch the slide back key or slide front key to move the LCD panel back and forth.

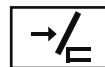

The LCD panel slides to the back.



The LCD panel slides to the front.

Basic operation

Adjusting the LCD panel angle

Important

- If you can hear the LCD panel knocking against your vehicle's console or dashboard, touch the flip down temporarily key from the flap menu to temporarily level the LCD panel.
- When adjusting the LCD panel angle, be sure to adjust from the flap menu. Forcibly adjusting the LCD panel by hand may damage it.



- 1 Press and hold OPEN/CLOSE to display the flap menu.
- 2 Touch the tilt down key or tilt up key to adjust the LCD panel to an easily viewable angle.

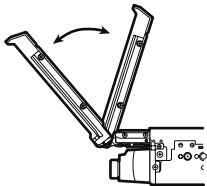

Laying the panel down.

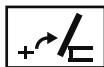

Returning the panel to the upright position.

- As the set angle is saved, the LCD panel will automatically be adjusted to the same position the next time the LCD panel is opened.

Inserting/ejecting/connecting media

CAUTION

Do not insert anything other than a disc into the disc-loading slot.

Inserting and ejecting a disc

Inserting a disc

- 1 Insert a disc into the disc-loading slot.

Ejecting a disc

- 1 Press **▲** button to eject a disc.

Plugging and unplugging a USB storage device

- This product may not achieve optimum performance with some USB storage devices.
- Connection via a USB hub is not possible.
- A USB cable is required for connection.

- 1 Pull out the plug from the USB port of the USB cable.
- 2 Plug a USB storage device into the USB cable.

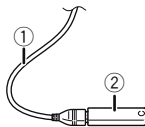

- ① USB cable
 - ② USB storage device
- Check that no data is being accessed before pulling out the USB storage device.

On first-time startup

1 Start the engine to boot up the system.

The "Select Program Language" screen appears.

- From the second time on, the screen shown will differ depending on the previous conditions.

2 Touch the language.

3 Touch **→**.

The "Speaker Mode Settings" screen appears.

4 Touch the speaker modes.

- **Standard Mode**
4-speaker system with front and rear speakers, or a 6-speaker system with front and rear speakers and subwoofers.
- **Network Mode**
3-way system with a high range speaker, middle range speaker and subwoofer (low range speaker) for reproduction of high, middle and low frequencies (bands).

WARNING

Do not use the unit in standard mode when a speaker system for 3-way network mode is connected to this unit. This may cause damage to the speakers.

5 Touch [OK].

The "Smartphone Setup" screen appears.

6 Touch the item.

- ☞ Refer to *Information on the connections and functions for each device* on page 20

7 Touch **→**.

The top menu screen appears.

- Once the speaker mode is set, the setting cannot be changed unless this product is restored to the default settings. Restore the default settings to change the speaker mode setting.
- ☞ Refer to *Restoring the default settings* on page 49

Basic operation

Switching the speaker mode

To change the speaker mode, you need to restore this product to the default settings.

- 1 Restore the default setting.**
 - Refer to *Restoring the default settings* on page 49

Basic operation

How to use the screens

Application menu screen  *4

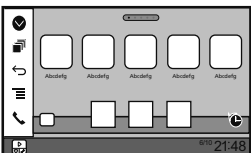

Depending on the connection method, the "smartphone setup" screen is displayed.

Application operation screen  *4

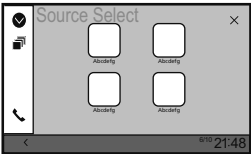

You can control the iPhone or smartphone applications directly on this product.

Time and date setting screen

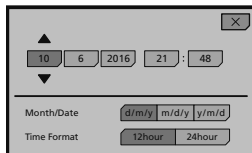

Setting menu screen

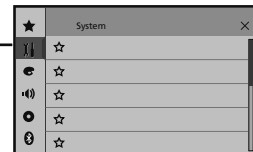

Top menu screen  *1  *2

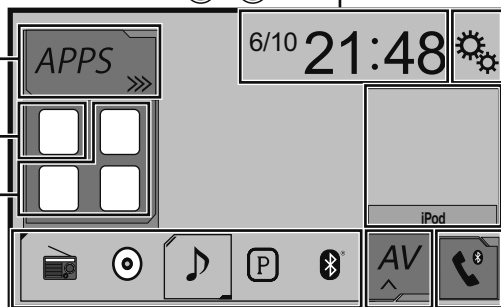

AV operation screen



Recent application icons

Favorite source icons  *3

AV source selection screen  *5



Phone menu screen



Basic operation

- *1 The top menu screen of this manual is the screen when using the **AppRadioOne**. The items displayed on the screen may vary depending on the connecting device or mode. When you connect an iPhone via Bluetooth wireless technology or a smartphone via USB cable, **"Smartphone Setup"** screen appears by touching [APPS].
- *2 By pressing the  button on any screen you can display the Top menu screen.
- *3 When you connect the external navigation system to this unit, the navigation mode key is displayed at the left bottom of the display.
- *4 By pressing the **MODE** button you can switch between the Application screen and the AV operation screen.
- *5 If you select **"Power OFF"**, you can turn off almost all functions. The **"Power OFF"** mode is released in the following cases:
 - An incoming call is received.
 - A rear view camera image is input when the vehicle reverses.
 - A button on this product is pressed.
 - The ignition switch is turned off (ACC OFF), then turned on (ACC ON).

Supported AV source

You can play or use the following sources with this product.

- Radio
- CD
- ROM (compressed audio files)
- DVD-Video
- USB

The following sources can be played back or used by connecting an auxiliary device.

- iPod
- Spotify®
- Pandora®
- Bluetooth audio (AVH-X7800BT)
- AV input (AV)
- AUX

Displaying the AV operation screen

- 1 Press .

2 Touch the AV operation key.

The AV operation screen appears.



- ① Displays the source list.

Selecting a source

Source on the AV source selection screen

- 1 Display the "AV source selection" screen.

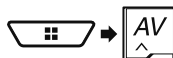

- 2 Touch the source icon.

When you select "Source OFF", the AV source is turned off.

Source on the source list

- 1 Display the source list.

➤ Refer to *Displaying the AV operation screen* on page 13

- 2 Touch the source key.

When you select "Source OFF", the AV source is turned off.

Changing the display order of sources

Changing the display order of source icons

- 1 Display the "AV source selection" screen.



- 2 Touch and hold a source icon, and drag the icon to the desired position.

Changing the display order of source keys

- 1 Display the source list.

➤ Refer to *Displaying the AV operation screen* on page 13

- 2 Touch .



- 3 Drag the source key to the desired position.

Using the touch panel

You can operate this product by touching the keys on the screen directly with your fingers.

To protect the LCD screen from damage, be sure to touch the screen only with your finger gently.

Common touch panel keys

-  Returns to the previous screen.
-  Closes the screen.

Basic operation

Operating list screens



- 1 Touching an item on the list allows you to narrow down the options and proceed to the next operation.
- 2 Appears when all characters are not displayed on the display area.
If you touch the key, the rest are scrolled for display.
- 3 Appears when items cannot be displayed on a single page.
Drag the slider bar or the list to view any hidden items.

Operating the time bar

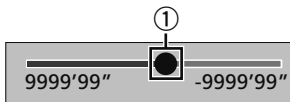

- 1 You can change the playback point by dragging the key.
 - ❑ Playback time corresponding to the position of the key is displayed while dragging the key.

Switching the operation panel

- 1 Touch **[Func.]**.

The hidden function keys appears.

- ❑ This key does not appear for some AV sources.

Registration and connection of Bluetooth® device

X7800BT

Displaying the "Bluetooth" screen

- 1 Press **[\square]**.
- 2 Touch **[\square]**, and then **[\square]**.
The "Bluetooth" screen appears.

Registering your Bluetooth devices

- ❑ If three devices are already paired, "Memory Full" is displayed. Delete a paired device first.
 - ➔ Refer to *Deleting a registered device* on page 14

- 1 Activate the Bluetooth wireless technology on your devices.

- 2 Display the "Bluetooth" screen.

- ➔ Refer to *Displaying the "Bluetooth" screen* on page 14

- 3 Touch **[Connection]**.

- 4 Touch **[Q]**.

The system searches for Bluetooth devices waiting for a connection and displays them in the list if a device is found.

- 5 Touch the Bluetooth device name.

After the device is successfully registered, a Bluetooth connection is established by the system. Once the connection is established, the device name is displayed on the list.

- ❑ If your device supports SSP (Secure Simple Pairing), a six-digit number appears on the display of this product. Touch **[Yes]** to pair the device.
- ❑ The Bluetooth connection can be also made by detecting this product from the Bluetooth device. Before registration, make sure that "Visibility" in the "Bluetooth" menu is set to "On". For details on a Bluetooth device operations, refer to the operating instructions supplied with the Bluetooth device.
 - ➔ Refer to *Switching visibility* on page 15
- ❑ Two cellular phones can be connected to this product at the same time.
 - ➔ Refer to *Switching the connected Bluetooth device* on page 15

- ❑ If you try to connect an unconnected cellular phone while two cellular phones are already connected, the first one of the two connected cellular phones will be disconnected and the unconnected cellular phone will be connected instead.

Setting Bluetooth device auto connection

This function connects the last connected Bluetooth device to this product automatically as soon as the two devices are less than a few meters apart.

The default setting is "On".

- ❑ If two Bluetooth devices were connected the last time, the two devices are connected to this product automatically in the order that they are registered in the device list.

- 1 Display the "Bluetooth" screen.

- ➔ Refer to *Displaying the "Bluetooth" screen* on page 14

- 2 Touch **[Auto Connect]** to switch "On" or "Off".

Deleting a registered device

⚠CAUTION

Never turn this product off while the paired Bluetooth device is being deleted.

- 1 Display the "Bluetooth" screen.

- ➔ Refer to *Displaying the "Bluetooth" screen* on page 14

- 2 Touch **[Connection]**.

- 3 Touch **[\square]**.

Connecting a registered Bluetooth device manually

Connect the Bluetooth device manually in the following cases:

- Two or more Bluetooth devices are registered, and you want to manually select the device to be used.
- You want to reconnect a disconnected Bluetooth device.
- Connection cannot be established automatically for some reason.

- 1 Activate the Bluetooth wireless technology on your devices.

Registration and connection of Bluetooth® device

2 Display the “Bluetooth” screen.

➤ Refer to *Displaying the “Bluetooth”* screen on page 14

3 Touch [Connection].

4 Touch the name of the device.

☐ To disconnect the device, touch the name of the connected device in the list.

Switching visibility

This function sets whether or not to make this product visible to the other device.

The default setting is “On”.

1 Display the “Bluetooth” screen.

➤ Refer to *Displaying the “Bluetooth”* screen on page 14

2 Touch [Visibility] to switch “On” or “Off”.

Entering the PIN code for Bluetooth wireless connection

To connect your Bluetooth device to this product, you need to enter a PIN code.

You can change the PIN code with this function.

☐ The default PIN code is “0000”.

1 Display the “Bluetooth” screen.

➤ Refer to *Displaying the “Bluetooth”* screen on page 14

2 Touch [PIN Code Input].

3 Touch [0] to [9] to input the pin code (up to 8-digits).

4 Touch .

Displaying the device information

1 Display the “Bluetooth” screen.

➤ Refer to *Displaying the “Bluetooth”* screen on page 14

2 Touch [Device Information].

The device name and address of the Bluetooth device on this product are displayed.

Clearing the Bluetooth memory

☐ This setting is available only when you stop your vehicle in a safe place and apply the parking brake.

⚠CAUTION

Never turn this product off while the Bluetooth memory is being cleared.

1 Display the “Bluetooth” screen.

➤ Refer to *Displaying the “Bluetooth”* screen on page 14

2 Touch [Bluetooth Memory Clear].

3 Touch [Clear].

The confirmation screen appears.

Updating Bluetooth software

This function is used to update this product with the latest Bluetooth software. For details on Bluetooth software and updating, refer to our website.

☐ The source is turned off and the Bluetooth connection is disconnected before the process starts.

☐ This setting is available only when you stop your vehicle in a safe place and apply the parking brake.

☐ You need to store the version update file to the USB storage device in advance.

⚠CAUTION

Never turn this product off and never disconnect the phone while the software is being updated.

1 Connect the USB storage device stored the version update file to this unit.

➤ Refer to *Plugging and unplugging a USB storage device* on page 10

2 Display the “Bluetooth” screen.

➤ Refer to *Displaying the “Bluetooth”* screen on page 14

3 Touch [BT Software Update].

4 Touch [Start].

Follow the on-screen instructions to finish updating the Bluetooth software.

Displaying the Bluetooth software version

If this product fails to operate properly, you may need to consult your dealer for repair.

In such cases, perform the following procedure to check the software version on this unit.

1 Display the “Bluetooth” screen.

➤ Refer to *Displaying the “Bluetooth”* screen on page 14

2 Touch [Bluetooth Version Information].

The version of this product’s Bluetooth module appears.

Switching the connected Bluetooth device

After registering and connecting the Bluetooth devices to this product, you can switch among the devices using the switch devices key in the phone function and some audio sources.

☐ You can register up to three Bluetooth devices on this product.

➤ Refer to *Registering your Bluetooth devices* on page 14

☐ You can connect one of the registered devices to this product. In cases where the registered device is equipped with a phone function, a total of two devices can be connected at the same time when using the phone function. If two of the three registered devices are already connected, you can connect the remaining third device to use the audio function only from the switch devices key on the audio source screen.

☐ The icon for the cellular phone currently being used is displayed on the “Phone menu” screen. If you connect two cellular phones to this product at the same time, you can switch between the cellular phones using the switch devices key. The contents of the phone menu are memorized for each connected cellular phone.

➤ Refer to *Hands-free phoning* on page 16

☐ The switch devices key will appear for some audio sources. The audio source may automatically switch to another source depending on the selected device.





Hands-free phoning

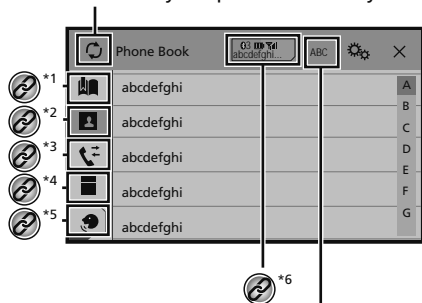

X7800BT

 Synchronizes the contacts on this product's phone book with the contacts on your phone manually.



 Switches the search language to English or system language.

-  *1 Switches to the preset dial screen.
➤ Refer to *Using the preset dial lists* on page 16
-  *2 Switches to the phone book list.
➤ Refer to *Calling a number in the phone book* on page 16
-  *3 Switches to the missed, received and dialed call lists.
➤ Refer to *Dialing from the history* on page 16
-  *4 Switches the mode to enter the phone number directly.
➤ Refer to *Direct dialing* on page 16

-  *5 Switches to the voice recognition function (for iPhone).
➤ Refer to *Using the voice recognition function (for iPhone)* on page 17
-  *6 If you connect two cellular phones to this product at the same time, you can switch between the cellular phones using the switch devices key. The following items are displayed on the key.
 - Name of the current cellular phone
 - List number of the current cellular phone
 - Battery status of the current cellular phone
 - Reception status of the current cellular phone➤ Refer to *Switching the connected Bluetooth device* on page 15

⚠️ CAUTION

For your safety, avoid talking on the phone as much as possible while driving.
To use this function you need to connect your cellular phone to this product via Bluetooth in advance.
➤ Refer to *Registration and connection of Bluetooth® device* on page 14

Displaying the Phone menu screen



- 1 Press .
- 2 Touch .

The Phone menu screen appears.

Making a phone call

You can make a phone call in many different ways.



Direct dialing

- 1 Display the "Phone menu" screen.
➤ Refer to *Displaying the Phone menu screen* on page 16
- 2 Touch .
- 3 Touch the number keys to enter the phone number.
- 4 Touch  to make a call.
- 5 Touch  to end the call.





- You may hear a noise when you hang up the phone.

Calling a number in the phone book

- The contacts on your phone will be automatically transferred to this product.
- "Visibility" of the "Bluetooth" screen should be on.
➤ Refer to *Switching visibility* on page 15
- If two cellular phones are automatically connected to this product with the Bluetooth device auto connect function, the phone book of the second phone is displayed.

- 1 Display the "Phone menu" screen.
➤ Refer to *Displaying the Phone menu screen* on page 16
- 2 Touch .
- 3 Touch the desired name on the list.
- 4 Touch the phone number.
The dial screen appears and dialing starts.
- 5 Touch  to end the call.

Dialing from the history

- 1 Display the "Phone menu" screen.
➤ Refer to *Displaying the Phone menu screen* on page 16
- 2 Touch .
- 3 Touch the item to switch the history list.
The following items are available:
 -  Received call list
 -  Dialed call list
 -  Missed call list

- 4 Touch the desired entry on the list to make a call.

The dial screen appears and dialing starts.

- 5 Touch  to end the call.

Using the preset dial lists

Registering a phone number

You can easily store up to six phone numbers per device as presets.

- 1 Display the "Phone menu" screen.
➤ Refer to *Displaying the Phone menu screen* on page 16

Hands-free phoning

2 Touch or .

On the “Phone Book” screen, touch the desired name to display the contact’s phone number.

3 Touch .

Dialing from the preset dial list

1 Display the “Phone menu” screen.

➤ Refer to *Displaying the Phone menu screen* on page 16

2 Touch .



3 Touch the desired item.

The dial screen appears and dialing starts.

Receiving a phone call

- When two phones are connected at the same time, if an incoming call is received on the second phone while you are talking on the first phone, the dial confirmation screen for the second phone will be displayed.

1 Touch to answer the call.

- If you touch  while getting a call waiting, you can switch to the talking person.
- Touch  to reject the call.

2 Touch to end the call.

Minimizing the dial confirmation screen

- The dial confirmation screen cannot be minimized on the AV operation screen.
- AV sources cannot be selected even if the dial confirmation screen is minimized while talking on the phone or receiving an incoming call.

1 Touch .

- Touch  to display the dial confirmation screen again.

Changing the phone settings

Setting auto answering

You can select whether or not to answer a call automatically.

The default setting is “Off”.

- Even if an incoming call is received on the other connected phone while you are talking on the phone, the incoming call will not be answered automatically.

1 Display the “Bluetooth” screen.

➤ Refer to *Displaying the “Bluetooth” screen* on page 14

2 Touch [Auto Answer] to switch “On” or “Off”.

Switching the ring tone

You can select whether or not to use this product’s ring tone. The default setting is “On”.

1 Display the “Bluetooth” screen.

➤ Refer to *Displaying the “Bluetooth” screen* on page 14

2 Touch [Ring Tone] to switch “On” or “Off”.

Inverting names in the phone book

You can use this function to change the order of the first and last names in the phone book.

1 Display the “Bluetooth” screen.

➤ Refer to *Displaying the “Bluetooth” screen* on page 14

2 Touch [Invert Name].

Setting the private mode

During a conversation, you can switch to private mode (talk directly on your cellular phone).

1 Touch or to turn private mode on or off.

- If two cellular phones are connected to this product and the first phone is set to private mode, you can receive incoming calls on the second phone while maintaining the call in progress on the first phone.
- When two cellular phones are connected to this product and private mode of the first phone is turned off, if an incoming call on the second phone is answered while a call is in progress on the first phone or while dialing or receiving a call on the first phone, the call, dialing, or receiving on the first phone is ended.

Adjusting the other party’s listening volume

This product can be adjusted to the other party’s listening volume.

1 Touch to switch between the three volume levels.

- Settings can be stored for each device.

Using the voice recognition function (for iPhone)

By connecting your iPhone to this product, you can use the voice recognition function (Siri Eyes Free Mode) on this product.

- When an iPhone running iOS 6.1 or higher is used, Siri Eyes Free Mode is available with this product.





- In this chapter, iPhone and iPod touch will be referred to as “iPhone”.

1 Display the “Phone menu” screen.

➤ Refer to *Displaying the Phone menu screen* on page 16

2 Touch .

The voice recognition function launches and the voice control screen appears.

- You can also launch the voice recognition function by pressing and holding .
- If two cellular phones are automatically connected to this product with the Bluetooth device auto connect function, the voice recognition function (Siri Eyes Free Mode) will be set on the second phone.
- If you want to use the voice recognition function (Siri Eyes Free Mode) on another connected iPhone, touch / /  to switch to the other iPhone. The iPhone that you switch to will be set as the current device.

Setting phone book auto synchronization

You can select whether or not to synchronize the the phone book with the contacts on your phone automatically when you connect the phone to this product.

The default setting is “Off”.

1 Display the “Bluetooth” screen.

➤ Refer to *Displaying the “Bluetooth” screen* on page 14

Hands-free phoning

2 Touch [Phone Book Auto Synchronize] to switch “On” or “Off”.

Notes for hands-free phoning

General notes

- Connection to all cellular phones featuring Bluetooth wireless technology is not guaranteed.
- The line-of-sight distance between this product and your cellular phone must be 10 meters or less when sending and receiving voice and data via Bluetooth technology.
- With some cellular phones, the ring sound may not be output from the speakers.
- If private mode is selected on the cellular phone, hands-free phoning may be disabled.

Registration and connection

- Cellular phone operations vary depending on the type of cellular phone. Refer to the instruction manual that came with your cellular phone for detailed instructions.
- When phone book transfer does not work, disconnect your phone and then perform pairing again from your phone to this product.

Making and receiving calls

- You may hear a noise in the following situations:
 - When you answer the phone using the button on the phone.
 - When the person on the other end of the line hangs up the phone.
- If the person on the other end of the line cannot hear the conversation due to an echo, decrease the volume level for hands-free phoning.
- With some cellular phones, even after you press the accept button on the cellular phone when a call comes in, hands-free phoning may not be performed.
- The registered name will appear if the phone number is already registered in the phone book. When one phone number is registered under different names, only the phone number will be displayed.

The received call and the dialed number histories

- You cannot make a call to the entry of an unknown user (no phone number) in the received call history.
- If calls are made by operating your cellular phone, no history data will be recorded in this product.

Phone book transfers

- If there are more than 1 000 phone book entries on your cellular phone, not all entries may download completely.
- Depending on the phone, this product may not display the phone book correctly.

- If the phone book in the phone contains image data, the phone book may not be transferred correctly.
- Depending on the cellular phone, phone book transfer may not be available.

Setup for iPod / iPhone or smartphone

When using an iPod / iPhone or a smartphone with this product, configure the settings of this product according to the device to be connected.

This section describes the settings required for each device.

The basic flow of iPod / iPhone or smartphone setup

- ① Select the method for connecting your device.
 - Refer to *Setting the device connection method* on page 18
- ② Connect your device to this product.
 - Refer to *Connection* on page 49
- ③ If necessary, connect your device to this product via Bluetooth connection.
 - Refer to *Registration and connection of Bluetooth® device* on page 14

Setting the device connection method

To use the application for iPhone or smartphone on this product, select the method for connecting your device. Settings are required according to the connected device.

1 Display the “System” setting screen.



2 Touch [Input/Output settings].

3 Touch [Smartphone Setup].

4 Touch the following settings.

- **Device:** Select the device to be connected.
- **Connection / Application:** Select the connection method.
- Refer to *Information on the connections and functions for each device* on page 20
The setting will change after the following processes are automatically executed.
 - The source is turned off.

Setup for iPod / iPhone or smartphone

- **AppRadioOne** is exited.
- The smartphone connection (USB and Bluetooth) is disconnected.

iPod compatibility

This product supports only the following iPod models and iPod software versions. Others may not work correctly.

- iPhone 4, 4s, 5, 5c, 5s, 6, 6 Plus: iOS 7.0 or later.
- iPhone 3GS: iOS 6.0.1
- iPod touch (4th, 5th generation): iOS 6.0.1
- iPod touch (3rd generation): iOS 5.1.1
- iPod touch (2nd generation): iOS 4.2.1
- iPod classic 160GB (2009): Ver. 2.0.4
- iPod classic 160GB (2008): Ver. 2.0.1
- iPod classic 80GB: Ver. 1.1.2
- iPod nano (7th generation)
- iPod nano (6th generation): Ver. 1.2
- iPod nano (5th generation): Ver. 1.0.2
- iPod nano (4th generation): Ver. 1.0.4
- iPod nano (3rd generation): Ver. 1.1.3
- You can connect and control an iPod compatible with this product by using separately sold connector cables.
- Operation methods may vary depending on the iPod model and the software version.
- Depending on the software version of the iPod, it may not be compatible with this product.

For details about iPod compatibility with this product, refer to the information on our website.

This manual applies to the following iPod models.

iPod with 30-pin connector

- iPhone 3GS, 4, 4s
- iPod touch 2nd, 3rd, 4th generation
- iPod classic 80GB, 160GB
- iPod nano 3rd, 4th, 5th, 6th generation

iPod with Lightning connector

- iPhone 6, 6 Plus
- iPhone 5, 5c, 5s
- iPod touch 5th generation
- iPod nano 7th generation

Android™ device compatibility

- Operation methods may vary depending on the Android device and the software version of the Android OS.
- Depending on the version of the Android OS, it may not be compatible with this product.
- Compatibility with all Android devices is not guaranteed.

For details about Android device compatibility with this product, refer to the information on our website.

Setup for iPod / iPhone or smartphone

Information on the connections and functions for each device

The settings and cables required for connecting each device, and the available sources are as follows.

iPod / iPhone with a 30-pin connector

Device connection method		When connecting via Bluetooth (AVH-X7800BT)	When connecting via CD-IU201V (sold separately)	When connecting via CD-IU51 (sold separately)
Smartphone Setup	Device	iPhone / iPod	iPhone / iPod	iPhone / iPod
	Connection	Wireless via BT	USB	USB
Bluetooth connection		Bluetooth connection is required.	—	—
Available sources	iPod (audio)	✓	✓	✓
	iPod (video)	—	✓	—
	Pandora	✓	✓	✓
	Spotify	✓	✓	✓

iPod / iPhone with a Lightning connector

Device connection method		When connecting via Bluetooth (AVH-X7800BT)	When connecting via CD-IU52 (sold separately)
Smartphone Setup	Device	iPhone / iPod	iPhone / iPod
	Connection	Wireless via BT	USB
Bluetooth connection		Bluetooth connection is required.	—
Available sources	iPod (audio)	✓	✓
	iPod (video)	—	—
	Pandora	✓	✓
	Spotify	✓	✓
	AppRadioOne	—	✓

Android device

Device connection method		When connecting via Bluetooth (AVH-X7800BT)	When connecting via CD-MU200 (sold separately)
Smartphone Setup	Device	Others	Others
	Application	USB / MTP	AppRadioOne
Bluetooth connection		Bluetooth connection is required.	—
Available sources	Pandora	✓	—
	Spotify	✓	—
	AppRadioOne	—	✓ When "Application" of "Smartphone Setup" is set to "AppRadioOne".

Radio

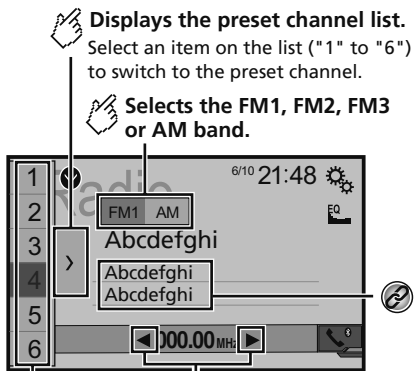

Displays the preset channel list. Select an item on the list ("1" to "6") to switch to the preset channel.

Selects the FM1, FM2, FM3 or AM band.

Performs manual tuning.

Performs seek tuning or non stop seek tuning.

Releasing the key in a few seconds, skips to the nearest station from the current frequency.

Keeping holding the key for a long seconds, performs non stop seek tuning.

Recalls the preset channel stored to a key from memory.

Stores the current broadcast frequency to a key.



Stores song information to an iPod.

➔ Refer to *Storing song information to an iPod (iTunes Tagging)* on page 48

- By pressing or , you can also switch the preset channels.
- By pressing and hold or and release, you can also perform seek tuning.
- By keeping touching and holding or , you can perform non stop seek tuning. Touch again to cancel.

Starting procedure

1 Display the "AV source selection" screen.

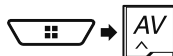

2 Touch [Radio].

The "Radio" screen appears.

Storing the strongest broadcast frequencies

The BSM (best stations memory) function automatically stores the six strongest broadcast frequencies under the preset tuning keys "1" to "6".

- Storing broadcast frequencies with BSM may replace those you have already saved.
- Previously stored broadcast frequencies may remain stored if the number of frequencies stored has not reached the limit.

1 Touch .

2 Touch to begin a search.

While the message is displayed, the six strongest broadcast frequencies will be stored under the preset tuning keys in order of their signal strength.

- If you touch [Cancel], the storage process is canceled.

Tuning into strong frequencies

- This setting is available only when "Radio" is selected as the source.

Local seek tuning allows you to only tune into those radio stations with sufficiently strong signals.

1 Display the "System" setting screen.



2 Touch [AV Source Settings].

3 Touch [Radio settings].

4 Touch [Local].

5 Touch the item.

- **Off** (default): Turns the seek tuning setting off.
- **Level1 to Level4**: Sets the level of sensitivity for FM to **Level1** to **Level4** (for AM **Level1** or **Level2**).
- The FM "Level4" (AM "Level2") setting allows reception of only stations with the strongest signals.

Track number indicator

Audio source screen 1

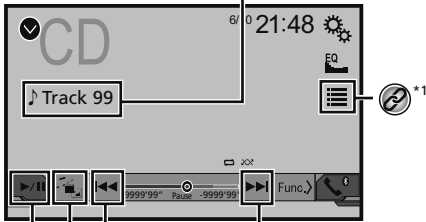

*2 Skips files forward or backward.

Switches between playback and pause.

Plays files in random order. This function is available for music CD.

: Does not play tracks in random order.

: Plays all tracks in random order.

Audio source screen 2

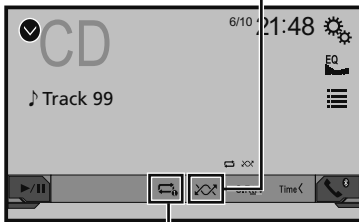

Sets a repeat play range.

: Repeats the current disc.

: Repeats the current track.

Hides the touch panel keys.
To display again the keys, touch anywhere on the screen.

Performs frame-by-frame playback.

Performs slow-motion playback.

Each time you touch it changes the speed in four steps in the following order: 1/16 → 1/8 → 1/4 → 1/2

Video source screen 1

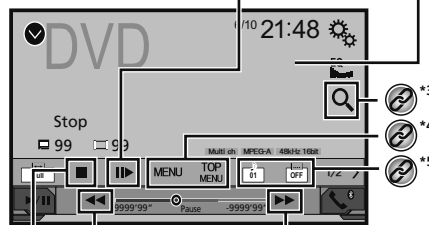

Performs fast reverse or fast forward.

Touch again to change play back the speed.

Stops playback.

Video source screen 2

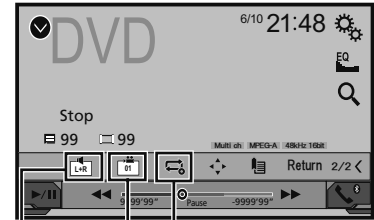

Sets a repeat play range.

: Repeats all files.

: Repeats the current chapter.

: Repeats the current title.

Changes the viewing angle (Multi-angle).

This function is available for DVDs featuring multi-angle recordings.

Selects the audio output from [L+R], [Left], [Right], [Mix].

This function is available for Video-CDs and DVDs recorded with LPCM audio.

Video source screen 2

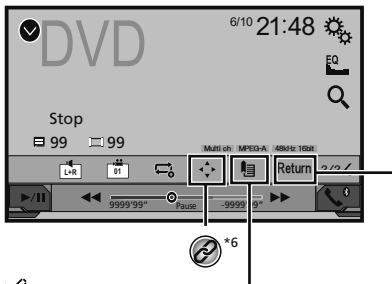

Resumes playback (Bookmark). This function is available for DVD-Video. You can memorize one point as a Bookmark for a disc (up to five discs). To clear the bookmark on the disc, touch and hold this key.

Returns and begins playback from the specified point. This function is available for DVD-Video and Video-CDs featuring PBC (playback control).

*1 Selects a track from the list.
 ↪ Refer to *Selecting files from the file name list* on page 23

*2 Switches the media file type.
 ↪ Refer to *Switching the media file type* on page 23

*3 Searches for the part you want to play.
 ↪ Refer to *Searching for the part you want to play* on page 23

*4 Displays the DVD menu.
 ↪ Refer to *Operating the DVD menu* on page 23

*5 Switches the subtitle/audio language.
 ↪ Refer to *Switching the subtitle/audio language* on page 23

*6 Displays the DVD menu keypad.
 ↪ Refer to *Operating the DVD menu using touch panel keys* on page 23

- By pressing **◀◀** or **▶▶**, you can also skip files/chapters forward or backward.
- By pressing and holding **◀◀** or **▶▶**, you can also perform fast reverse or fast forward.
- If a Video-CD with PBC On is being played, **[PBCOn]** appears.
- You can set the screen size for the video image.
- ↪ Refer to *Common operations* on page 47

Starting procedure

You can play a normal music CD, Video-CD or DVD-Video using the built-in drive of this product.

⚠ CAUTION

For safety reasons, video images cannot be viewed while your vehicle is in motion. To view video images, stop in a safe place and apply the parking brake.

1 Insert the disc.

The source changes and then playback will start.

- ↪ Refer to *Inserting and ejecting a disc* on page 10
- If the disc is already set, select **[Disc]** as the playing source.

Selecting files from the file name list

1 Touch **[List]**.

2 Touch a track on the list to play back.

Switching the media file type

When playing a digital media containing a mixture of various media file types you can switch between media file types to play.

1 Touch **[Media]**.

2 Touch the item.

- **Music:**
Switches the media file type to music (compressed audio).
- **Video:**
Switches the media file type to video.
- **CD-DA:**

Switches the media file type to CD (audio data (CD-DA)).

Searching for the part you want to play

- For DVD-Videos, you can select **[Title]**, **[Chapter]** or **[10Key]**.
- For Video-CDs, you can select **[Track]** or **[10Key]** (PBC only).

1 Touch **[Q]**.

2 Touch the item to select the search function.

3 Touch **[0]** to **[9]** to input the desired number.

- To cancel an input number, touch **[C]**.

4 Touch **[▶]** to start playback from the number you registered.

Operating the DVD menu

You can operate the DVD menu by touching the menu item on the screen directly.

- This function may not work properly with some DVD disc content. In that case, use touch panel keys to operate the DVD menu.

1 Touch **[TOP MENU]** or **[MENU]**.

2 Touch the desired menu item.

Switching the subtitle/audio language

1 Touch **[SUB]** or **[AUD]** to change the language.

- **[SUB]:** Changes the subtitle language.
- **[AUD]:** Changes the audio language.

- You can also switch the subtitle/audio languages using the "DVD/DivX Setup" menu.

↪ Refer to *Setting the top-priority languages* on page 45

Operating the DVD menu using touch panel keys

If items on the DVD menu appear, the touch panel keys may overlay them. If so, select an item using those touch panel keys.

1 Touch **[Q]**.

2 Touch **◀**, **▶**, **▲** or **▼** to select the desired menu item.

Disc

3 Touch

- The way to display the menu differs depending on the disc.
- If you touch , you can operate the DVD menu directly.

Compressed files

Audio source screen 1 (Example: USB)

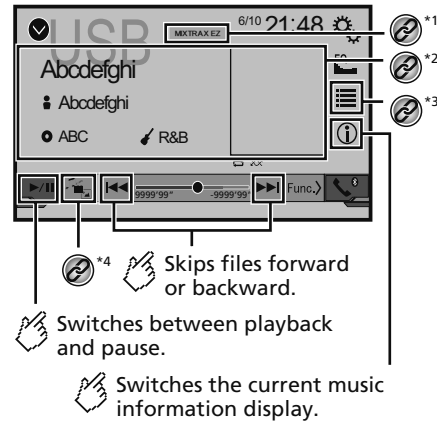

 Plays files in random order.



: Does not play files in random order.



: Plays all files within the repeat range in random order.

Audio source screen 2 (Example: USB)



Sets a repeat play range.



or  : Repeats all files.



: Repeats the current folder.



: Repeats the current file.



Selects the previous folder or the next folder.



Constructs the database for using the Music Browse mode.

This function is available only for USB.

Compressed files

Hides the touch panel keys.
To display again the keys,
touch anywhere on the screen.

Video source screen (Example: Disc)



Sets a repeat play range.

- or : Repeats all files.
- : Repeats the current folder.
- : Repeats the current file.

Performs frame-by-frame playback.

Performs slow-motion playback.

Stops playback.

Video source screen (Example: Disc)



Performs fast reverse
or fast forward.
Touch again to change the
playback speed.

Switches between
playback and pause.

Hides the touch panel keys.
To display again the keys,
touch anywhere on the screen.

Rotates the displayed
picture 90° clockwise.

Selects the previous
or next folder.

Still image screen



Sets a repeat play range.

- : Repeats all files.
- : Repeats the current folder.

Plays files in random order.

- : Does not play files in random order.
- : Plays all files in the current repeat
play range in random order.

Compressed files

Still image screen



*4 Skips files forward or backward.

Switches between playback and pause.

- *1 Displays the MIXTRAX screen.
 - ➔ Refer to *MIXTRAX* on page 36
- *2 Displays the link search screen.
 - ➔ This function is available for the USB storage device only.
 - ➔ Refer to *Selecting a song from the list related to the song currently playing (link search)* on page 27
- *3 Selects a file from the list.
 - ➔ Refer to *Selecting files from the file name list* on page 26
 - ☐ When you play compressed audio files stored in a USB storage device, you can search for a file using Music Browse.
 - ➔ Refer to *Selecting a file by Music Browse* on page 26
- *4 Switches the media file type.
 - ➔ Refer to *Switching the media file type* on page 26
- *5 Switches the subtitle/audio language.
 - ➔ This function is available only for compressed video files stored on a disc.
 - ➔ Refer to *Switching the subtitle/audio language* on page 23
- *6 Saves the current image as the wallpaper.
 - ➔ Refer to *Saving the image as the wallpaper* on page 27

You can play compressed audio, compressed video or still image files stored in a disc or a USB storage device.

- ➔ Refer to *Media compatibility chart* on page 61
- ☐ By pressing or , you can also skip files forward or backward.
- ☐ By pressing and holding or , you can perform fast reverse or fast forward.
- ☐ By pressing and holding or on the still image file, you can search through 10 JPEG files at a time. If the file currently being played is the first or last file in the folder, the search is not performed.
- ☐ JPEG images are not displayed in the rear display.
- ☐ You can set the screen size for the video and JPEG images.
 - ➔ Refer to *Common operations* on page 47

⚠CAUTION

For safety reasons, video images cannot be viewed while your vehicle is in motion. To view video images, stop in a safe place and apply the parking brake.

Starting procedure (for Disc)

1 Insert the disc.

- ➔ The source changes and then playback will start.
- ➔ Refer to *Inserting and ejecting a disc* on page 10
- ☐ If the disc is already set, select **[Disc]** as the playing source.

Starting procedure (for USB)

1 Display the “AV source selection” screen.

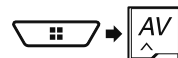

2 Plug the USB storage device.

- ➔ Refer to *Plugging and unplugging a USB storage device* on page 10

3 Touch [USB].

- ☐ Play back is performed in order of folder numbers. Folders are skipped if they contain no playable files.

Operations common to all file types

Selecting files from the file name list

You can find files or folders to play back using the file name or folder name list.

1 Touch .

2 Touch a file on the list to play back.

- ☐ Touching a folder on the list shows its contents. You can play a file on the list by touching it.

Switching the media file type

When playing a digital media containing a mixture of various media file types you can switch between media file types to play.

1 Touch .

2 Touch the item.

- **Music:**
 - Switches the media file type to music (compressed audio).
- **Video:**
 - Switches the media file type to video.
- **CD-DA:**
 - Switches the media file type to CD (audio data (CD-DA)).
- **Photo:**
 - Switches the media file type to still image (JPEG data).

Audio file operations

Selecting a file by Music Browse

- ☐ This function is available for the USB storage device only.

1 Touch to create a database.

Music Browse mode will be available after the database has been created.

2 Touch .

3 Touch the desired category to display the file list.

4 Touch the item.

Refine the item until the desired song title or file name is displayed on the list.

Compressed files

- 5 Touch the desired song title or file name to play back.

Selecting a song from the list related to the song currently playing (link search)

- If you touch the artwork, the list of songs in the album is displayed.

- 1 Touch .
- 2 Touch song information to open the list of songs.
- 3 Touch the song to play back.

Still image file operations

Saving the image as the wallpaper

You can save the currently displayed image in the memory of this product and set it as the wallpaper for the AV screen or the top menu screen.

- 1 Display an image on the screen.

➤ Refer to *Starting procedure (for USB)* on page 26

➤ Refer to *Operations common to all file types* on page 26

- 2 Touch  on the image.

- 3 Touch the following items.

- **As AVScreen:**

Saves the image as the wallpaper for the AV screen.

- **As HomeScreen:**

Saves the image as the wallpaper for the top menu screen.

- **As Both:**

Saves the image as the wallpaper for both the AV screen and top menu screen.

- 4 Touch “Yes” to overwrite the image.

- If you save the new image, the current wallpaper is overwritten.

Setting the slideshow interval

JPEG files can be viewed as a slideshow on this product. In this setting, the interval between each image can be set.

The default setting is “10sec”.

- This setting is available during playback of the JPEG files.

- 1 Display the “Video Setup” screen.



- 2 Touch [Time Per Photo Slide].

- 3 Touch the item.

The following items are available:

5sec. 10sec. 15sec. Manual.

iPod

Audio source screen 1



 Skips files forward or backward.

 Switches between playback and pause.

Changes the audiobook speed.

- : Normal playback
- : Fast playback
- : Slow-motion playback

Plays files in random order.

- : Plays randomly songs or videos within the selected list.
- : Plays album randomly.

Audio source screen 2

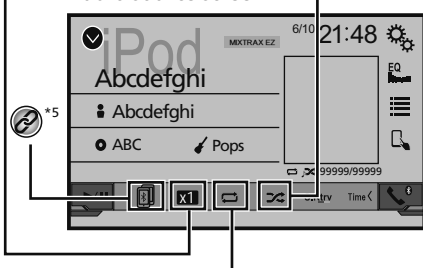

Sets a repeat play range.

- : Repeats all in the selected list.
- : Repeats the current song or video.

Video source screen



Performs fast reverse or fast forward.

- *1 Displays the "MIXTRAX" screen.
➤ Refer to *MIXTRAX* on page 36
- *2 Displays the link search screen.
➤ Refer to *Selecting a song from the list related to the song currently playing (link search)* on page 29
- *3 Selects a song or video from the list.
➤ Refer to *Selecting song or video sources from the playlist screen* on page 28
- *4 Switches the control mode to "App Mode".
➤ Refer to *Using this product's iPod function from your iPod* on page 29
- *5 Switches among the Bluetooth devices when the devices are connected to this product via Bluetooth. (AVH-X7800BT)
➤ Refer to *Switching the connected Bluetooth device* on page 15

- By pressing the or , you can also skip files forward or backward.
- By pressing and hold the or , you can also perform fast reverse or fast forward.
- You can set the screen size for the video image.
➤ Refer to *Common operations* on page 47

Connecting your iPod

When connecting an iPod to this product, select the method for connecting your device. Settings are required according to the connected device.

- Refer to *Setup for iPod / iPhone or smartphone* on page 18

- The available sources vary depending on the selected method for connecting your device.
➤ Refer to *Information on the connections and functions for each device* on page 20

CAUTION

For safety reasons, video images cannot be viewed while your vehicle is in motion. To view video images, stop in a safe place and apply the parking brake.

Starting procedure

1 Connect your iPod.

- Refer to *Connecting your iPod* on page 28
- The source changes and then playback will start.

- When connecting an iPhone or iPod touch, quit all applications before connecting the device.

2 Display the "AV source selection" screen.



3 Touch [iPod].

Selecting song or video sources from the playlist screen

You can search for the song or video you want to play from the playlist screen.

1 Touch .

2 Touch or to switch the music or video category list.

3 Touch the category.

If you use English as the system language, the alphabet search function is available. Touch the initial search bar to use this function.

4 Touch the title of the list.

If you can not find the desired song or video, try to search again according to the above steps.

5 Start playback of the selected list.

- Depending on the generation or version of the iPod, some functions may not be available.
- You can play playlists created with the **MusicSphere** application. The application is available on our website.

Using this product's iPod function from your iPod

You can control this product's iPod function from the iPod on "App Mode". The application screen of the iPod can be displayed on this product, and the music files and video files are played back with this product.

- ❑ This function is not available when using iPod function with an iPhone 6 Plus, iPhone 6, iPhone 5s, iPhone 5c, iPhone 5, or iPod touch (5th generation).
- ❑ While this function is in use, the iPod will not turn off even if the ignition key is turned off. Operate the iPod to turn off the power.

1 Touch .

2 Operate the connected iPod to select a video or song and play.

- ❑ Some functions are still accessible from this product even if the control mode is set to "App Mode". However, the operation will depend on your applications.
- ❑ Touch  to switch the control mode.



Selecting a song from the list related to the song currently playing (link search)

- ❑ If you touch the artwork, the list of songs in the album is displayed.

1 Touch song information to open the list of songs.

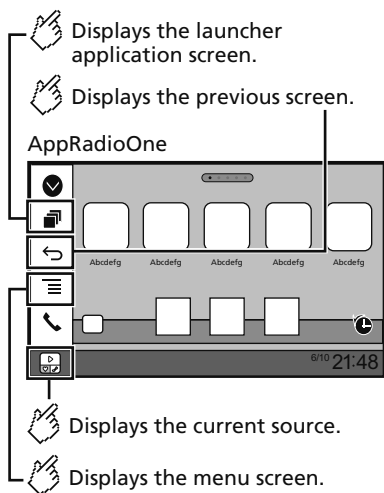
2 Touch the song to play back.



- ❑ Press the **DISP** button to hide the App control side bar. Press the **DISP** button again to display it again.
- ❑  and  are not available depending on the type of device.

⚠WARNING

Certain uses of an iPhone or a smartphone may not be legal while driving in your jurisdiction, so you must be aware of and obey any such restrictions.

If in doubt as to a particular function, only perform it while the car is parked.

No feature should be used unless it is safe to do so under the driving conditions you are experiencing.

Using AppRadioOne

You can control applications for an iPhone or a smartphone directly from the screen (AppRadioOne).

In AppRadioOne, you can operate applications with finger gestures such as tapping, dragging, scrolling or flicking on the screen of this product.

- ❑ The compatible finger gestures vary depending on the application for an iPhone or a smartphone.

- ❑ Even though an application is not compatible with AppRadioOne, depending on the application an image may be displayed. But you can not operate the application.

To use AppRadioOne, install the AppRadio app on the iPhone or smartphone in advance. For details about the AppRadio app, visit the following site:

For U.S.A.

<http://www.pioneerlectronics.com/AppRadioOne>

For Canada

<http://www.pioneerlectronics.ca/AppRadioOne>

- ❑ Be sure to read Using app-based connected content before you perform this operation.
- ➔ Refer to *Using app-based connected content* on page 64

- Pioneer is not liable for any issues that may arise from incorrect or flawed app-based content.
- The content and functionality of the supported applications are the responsibility of the App providers.
- In AppRadioOne, functionality through the product is limited while driving, with available functions determined by the App providers.
- Availability of AppRadioOne functionality is determined by the App provider, and not determined by Pioneer.
- AppRadioOne allows access to applications other than those listed (subject to limitations while driving), but the extent to which content can be used is determined by the App providers.

Starting procedure

When connecting an iPhone or smartphone to this product, you must select the method for connecting your device. Settings are required according to the connected device.

- ➔ Refer to *Setup for iPod / iPhone or smartphone* on page 18

For iPhone users

1 Connect your iPhone.

- ➔ Refer to *iPhone with Lightning connector* on page 52

2 Press .

3 Touch [APPS].

When the application is ready to launch, messages appear on the screen of this product.

4 Use your iPhone to launch the application.

The AppRadio app is launched.

5 Touch [OK].

The AppRadioOne screen (Application menu screen) appears.

For smartphone (Android) users

1 Unlock your smartphone and connect it to this product via USB.

☞ Refer to *Android device* on page 52

2 Press **⏏**.

3 Touch [APPS].

The **AppRadioOne** app is launched, and the **AppRadioOne** screen (Application menu screen) appears.

Common operation of all device

- ☐ If you connect your device while an **AppRadioOne** compatible application is already running, the application operation screen will appear on this product.
- ☐ Touch the desired application icon after the AppRadio app is launched.
- ☐ The desired application is launched, and the application operation screen appears.
- ☐ Press **⏏** to go back to the Top menu screen.

Using the keyboard

When you tap the text input area of an application for iPhone, a keyboard will be displayed on the screen. You can input the desired text directly from this product.

⚠CAUTION

For your safety, the keyboard functionality is only available when the vehicle is stopped and the parking brake is engaged.

- ☐ This function is only available in **AppRadioOne** on the iPhone.

1 Start up the AppRadioOne.

☞ Refer to *Starting procedure* on page 29

2 Touch the text input area on the application operation screen.

A keyboard for entering text appears.

- ☐ The language of the keyboard can be changed.
- ☞ Refer to *Setting the keyboard language with the application for iPhone* on page 38

Using the audio mix function

You can output audio mixing AV source and an application for iPhone or smartphone when the **AppRadioOne** is used.

- ☐ Depending on the application or the AV source, this function may not be available.

1 Start up the AppRadioOne.

2 Press the Volume (+/-) button.

The audio mix menu will be displayed on the screen.

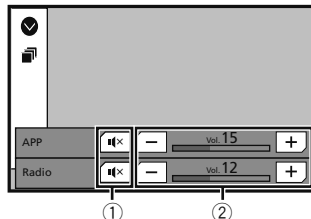

- ① Touch to mute. Touch again to unmute so that the sound is not mixed.
- ② Adjusts the audio volume. Each touch of **[+]** or **[-]** increases or decreases the volume level.
- ☐ The AV operation screen and the Application screen can be switched by pressing **⏏**.

- ☞ Gives a "Thumbs Down" to the playing track and skips to the next track.

Playback screen 1



- ☞ Gives a "Thumbs Up" to the playing track.
- ☞ Skips tracks forward.
- ☞ Switches between playback and pause.

- Displays the preset station list.
Select an item on the list ("1" to "6") to switch to the preset station.

Playback screen 2



- Adds information for the track currently playing to bookmarks.

- Recalls the preset station stored to a key from memory.

- *1 Selects a Pandora station from the list.
➔ Refer to *Selecting a Pandora station from the list* on page 31
- *2 Creates a new station.
➔ Refer to *Adding a station* on page 31
- *3 Switches among the Bluetooth devices when the devices are connected to this product via Bluetooth. (AVH-X7800BT)
➔ Refer to *Switching the connected Bluetooth device* on page 15

- By pressing the ►►► button, you can skip songs forward.
- ⏪ and ⏩ are not available when using a shared station.
- In this chapter, iPhone and iPod touch will be referred to as "iPhone".

⚠WARNING

Certain uses of an iPhone or a smartphone may not be legal while driving in your jurisdiction, so you must be aware of and obey any such restrictions.

If in doubt as to a particular function, only perform it while the car is parked.

No feature should be used unless it is safe to do so under the driving conditions you are experiencing.

Pandora operations

You can enjoy Pandora by connecting an iPhone or a smartphone that has the Pandora application installed.

📌Important

- Requirements to access Pandora using Pioneer car audio/video
- ➔ Refer to *Setup for iPod / iPhone or smartphone* on page 18
- Please update the firmware of the Pandora application to the latest version before use. Download it from the iTunes App Store or Google Play.
- Create a free or a paid account online. You can create the account in the Pandora application from your iPhone or from the website (<http://www.pandora.com/account/register>).
- To use the Pandora service, you need to connect to the Internet via 3G, EDGE, LTE (4G) or Wi-Fi network. If the data plan for your iPhone does not provide for unlimited data usage, additional charges from your carrier may apply.

Limitations:

- Depending on the availability of the Internet, you may not be able to receive the Pandora service.
- The Pandora service is subject to change without notice. The service could be affected by any of the following: firmware version of the iPhone, firmware version of the Pandora application, changes to the Pandora music service.
- Certain functions of the Pandora service are not available when accessing the service through Pioneer car audio/video products. They include, but are not limited to the following: creating new stations, deleting stations, sending information about current stations, buying tracks from iTunes, viewing additional text information, logging in to Pandora, adjusting Cell Network Audio Quality.
- Pandora internet radio is a music service not affiliated with Pioneer. More information is available at

<http://www.pandora.com>

- The Pandora mobile application is available for most iPhone and smartphone, please visit <http://www.pandora.com/everywhere/mobile> for the latest compatibility information.

Starting procedure

When connecting an iPhone or smartphone to this product, select the method for connecting your device. Settings are required according to the connected device.

- ➔ Refer to *Setup for iPod / iPhone or smartphone* on page 18
- ☐ You can use the Pandora service by connecting an iPhone via USB or Bluetooth.
- ☐ If you use a smartphone, connect via Bluetooth. (AVH-X7800BT)
- ➔ Refer to *iPhone with 30-pin connector* on page 52
- ➔ Refer to *iPhone with Lightning connector* on page 52
- ➔ Refer to *Registering your Bluetooth devices* on page 14

1 Unlock and connect your device.

2 Display the "AV source selection" screen.



3 Touch [Pandora].

Selecting a Pandora station from the list

1 Touch [List].

The following items are available:

- [List]: switches to the station list.
- [Genre]: switches to the genre list.
- [Track]: plays only one track based on particular musical characteristics from several shuffled stations.
- **A-Z**: sorts the items in the list alphabetically.
- **Date**: sorts the items in the list in the order of the dates.
- [Delete]: deletes the station.
- ☐ Shared stations are indicated by [Shared].

Adding a station

1 Touch [List].

2 Touch [Track] (from track) or [Artist] (from artist).

A new station is created.

Storing the preset stations

You can store six stations to the preset keys "1" to "6".

1 Touch [1].

2 Touch and hold an item on the preset station list for a few seconds.

The current station is stored under a preset key.

Playback screen 1 (Track)



Skips tracks forward or backward.

Saves or deletes the current song information to or from "Your Music".

Switches between playback and pause.

Plays tracks in random order.

Playback screen 2 (Track)



Sets a repeat play range.



Switches to radio mode.

Playback screen 1 (Radio mode)



- Skips tracks forward.
- Saves or deletes the current song information to or from "Your Music".
- Switches between playback and pause.

Gives a "Thumbs Down" to the playing track and skips to the next track.

Playback screen 2 (Radio mode)



- Gives a "Thumbs Down" to the playing track.
- Gives a "Thumbs Up" to the playing track.
- Starts new radio mode.

- *1 Selects a track or station from the list.
➤ Refer to *Selecting a track or station from the list* on page 34
- *2 Switches among the Bluetooth devices when the devices are connected to this product via Bluetooth. (AVH-X7800BT)
➤ Refer to *Switching the connected Bluetooth device* on page 15

By pressing the ◀◀ or ▶▶ button, you can also skip songs forward or backward.

⚠WARNING

Certain uses of an iPhone or a smartphone may not be legal while driving in your jurisdiction, so you must be aware of and obey any such restrictions.

If in doubt as to a particular function, only perform it while the car is parked.

No feature should be used unless it is safe to do so under the driving conditions you are experiencing.

Using Spotify with your Pioneer car audio/video

To enjoy Spotify as you drive, first download the Spotify app to your iPhone or smartphone. You can download it from the iTunes App Store or Google Play. Choose a free account or a paid Premium account, either in the app or at spotify.com. A Premium account gives you more features, like offline listening. If you have Spotify already, please update the app so you have the latest version. Then connect your phone to your car. Now you can take your music on the road.

🔗Important

- Confirm the requirements to access Spotify using Pioneer car audio/video.
- Refer to *Setup for iPod / iPhone or smartphone* on page 18
- To use Spotify, you need to connect to the Internet via 3G, EDGE, LTE (4G) or a Wi-Fi network. If the data plan for your iPhone or smartphone does not provide for unlimited data usage, additional charges from your carrier may apply.
- For information on the countries and regions where Spotify can be used, take a look at <https://www.spotify.com/us/select-your-country/>.

Limitations:

- Depending on the availability of the Internet, you may not be able to receive the Spotify service.
- The Spotify service is subject to change without notice. The service could be affected by any of the following: firmware version of the iPhone or smartphone, firmware version of the Spotify application, changes to the Spotify music service.
- Certain functions of the Spotify service are not available when accessing the service through Pioneer car audio/video products.
- Spotify is a music service not affiliated with Pioneer. More information is available at <https://support.spotify.com/>
- The Spotify application is available for most iPhone and smartphone, please visit <https://support.spotify.com/> for the latest compatibility information.

Starting procedure

When connecting an iPhone or smartphone to this product, select the method for connecting your device. Settings are required according to the connected device.

- Refer to *Setup for iPod / iPhone or smartphone* on page 18

- ❑ You can use the Spotify service by connecting an iPhone via USB or Bluetooth.
- ❑ When using a smartphone, connect via Bluetooth. (AVH-X7800BT)
- Refer to *iPhone with 30-pin connector* on page 52
- Refer to *iPhone with Lightning connector* on page 52
- Refer to *Registering your Bluetooth devices* on page 14

- 1 **Unlock and connect your device.**
- 2 **Display the “System” setting screen.**



- 3 **Touch [AV Source Settings].**
- 4 **Confirm that “Spotify” is turned on.**
- 5 **Display the “AV source selection” screen.**



- 6 **Touch [Spotify] on the AV source selection screen.**

Selecting a track or station from the list

- 1 **Touch [List].**

The following items are available:

- **Your Music:** Selects a track or station from the list of saved song information.
- **Browse:** Selects a track from the category list.
- **Radio:** Selects a station from the station list.

X7800BT

Playback screen 1



Skips files forward or backward.

Track number indicator

Plays files in random order.

Playback screen 2



Sets a repeat play range.

Switches between playback and pause.

- *1 Selects a file from the list.
➤ Refer to *Selecting files from the file name list* on page 35
- *2 Switches among the Bluetooth devices when the devices are connected to this product via Bluetooth.
➤ Refer to *Switching the connected Bluetooth device* on page 15

- ❑ Depending on the Bluetooth audio player connected to this product, the available operations with this product may be limited to the following two levels:
 - A2DP (Advanced Audio Distribution Profile): Only playing back songs on your audio player is possible.
 - A2DP and AVRCP (Audio/Video Remote Control Profile): Playing back, pausing, selecting songs, etc., are possible.
- ❑ By pressing the **◀◀** or **▶▶** button, you can also skip files forward or backward.
- ❑ By pressing and hold the **◀◀** or **▶▶** button, you can also perform fast reverse or fast forward.
- ❑ Depending on the Bluetooth device connected to this product, the available operations with this product may be limited or differ from the descriptions in this manual.
- ❑ While you are listening to songs on your Bluetooth device, please refrain from operating the phone function as much as possible. If you try operating, the signal may cause noise for song playback.
- ❑ When you are talking on the Bluetooth device connected to this product via Bluetooth, it may pause playback.

Starting procedure

- ❑ Before using the Bluetooth audio player, register and connect the device to this product.
➤ Refer to *Registering your Bluetooth devices* on page 14

- 1 **Pull out the connecting cable for using AppRadioOne.**

- ❑ You cannot use Bluetooth device when the connecting cable for using **AppRadioOne** is connected.

- 2 **Display the “System” setting screen.**



- 3 **Touch [AV Source Settings].**
- 4 **Confirm that “Bluetooth Audio” is turned on.**
- 5 **Display the “AV source selection” screen.**

Bluetooth audio player



- 6 Touch [Bluetooth Audio] on the AV source selection screen.

Selecting files from the file name list

- ❑ This function is available only when the AVRCP version of the Bluetooth device is 1.4 or higher.

- 1 Touch .
- 2 Touch a file or a folder on the list to play back.

AUX source



-  Switches between the video input and the sound input.

- ❑ A Mini-jack AV cable (CD-RM10) (sold separately) is required for connection.
 - ➔ Refer to *External video component and the display* on page 53

⚠CAUTION

For safety reasons, video images cannot be viewed while your vehicle is in motion. To view video images, stop in a safe place and apply the parking brake.

Starting procedure

You can display the video image output by the device connected to video input.

- 1 Display the "System" setting screen.



- 2 Touch [Input/Output settings].
- 3 Confirm that "AUX Input" is turned on.
- 4 Display the "AV source selection" screen.

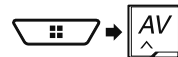

- 5 Touch [AUX].
The image is displayed on the screen.

Setting the video signal

When you connect this product to an AUX equipment, select the suitable video signal setting.
The default setting is "Auto".

- ❑ You can operate this function only for the video signal input into the AUX input.

- 1 Display the "Video Setup" screen.



- 2 Touch [Video Signal Setting].
- 3 Touch [AUX].
- 4 Touch the item.

The following items are available:

Auto, PAL, NTSC, PAL-M, PAL-N, SECAM.

AV input

You can display the video image output by the device connected to this product.

- Refer to *External video component and the display* on page 53

⚠CAUTION

For safety reasons, video images cannot be viewed while your vehicle is in motion. To view video images, stop in a safe place and apply the parking brake.

Starting procedure

You can display the video image output by the device connected to video input.

1 Display the “System” setting screen.



2 Touch [Input/Output settings].

3 Set the setting to “On”.

4 Display the “AV source selection” screen.



5 Touch [AV].

The image is displayed on the screen.

Setting the video signal

When you connect this product to an AV equipment, select the suitable video signal setting.

The default setting is “Auto”.

- ☐ You can operate this function only for the video signal input into the AV input.

1 Display the “Video Setup” screen.



2 Touch [Video Signal Setting].

3 Touch [AV].

4 Touch the item.

The following items are available:

Auto, PAL, NTSC, PAL-M, PAL-N, SECAM.

MIXTRAX



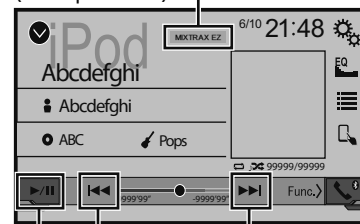

 Activates the MIXTRAX mode.

(Example: iPod)



 Selects a track.

 Switches between playback and pause.

- ☐ By pressing the  or  button, you can also skip files forward or backward.
- ☐ By pressing and hold the  or  button, you can also perform fast reverse or fast forward.

MIXTRAX operation

MIXTRAX is original technology for creating non-stop mixes of selections from your audio library, complete with DJ effects that make them sound.

MIXTRAX EZ operation

You can use this unit to play iPod/USB audio files.

MIXTRAX EZ is used to add a variety of sound effects between songs for arranging the pauses between songs.

It allows you to enjoy listening to music non-stop.

- This function is only available when a file on a USB storage device or a song on an iPod is being played.
- This function is not available when the control mode is set to App Mode.
- Depending on the file/song, sound effects may not be available.
- Depending on the file/song, non-stop playback may not be available.

Displaying the “MIXTRAX Settings” screen

- 1 Press **⏏**.
- 2 Touch **[M]**, and then **[AV Source Settings]**.
- 3 Touch **[MIXTRAX Settings]**.
The “MIXTRAX Settings” screen appears.

Setting the playback portion

You can specify the playback portion.
The default setting is “60s”.

- 1 Display the “MIXTRAX Settings” screen.
➤ Refer to *Displaying the “MIXTRAX Settings” screen* on page 37
- 2 Touch **[Short Playback Mode]**.
- 3 Touch the item.
The following items are available:
Off, 60s, 90s, 120s, 150s, 180s, Random.

Setting the display effect

You can set the effect display for MIXTRAX.
The default setting is “On”.

- 1 Display the “MIXTRAX Settings” screen.
➤ Refer to *Displaying the “MIXTRAX Settings” screen* on page 37
- 2 Touch **[Display Effect]** to switch “On” or “Off”.

Setting the cut-in effect

You can set the effect tone that sounds when you skip tracks forward or backward.
The default setting is “On”.

- 1 Display the “MIXTRAX Settings” screen.
➤ Refer to *Displaying the “MIXTRAX Settings” screen* on page 37
- 2 Touch **[Cut-In Effect]** to switch “On” or “Off”.

Setting the MIXTRAX effect

You can set and play back the MIXTRAX effect that you want.
The default setting is “Standard”.

- 1 Display the “MIXTRAX Settings” screen.
➤ Refer to *Displaying the “MIXTRAX Settings” screen* on page 37
- 2 Touch **[Effect Setting]**.
- 3 Touch the item.
The following items are available:
Standard, Simple, Custom
 When you select “Custom”, check the effect that you want.

Setting the flash pattern

The flashing color changes with the changes in the sound and bass levels.

- 1 Display the “MIXTRAX Settings” screen.
➤ Refer to *Displaying the “MIXTRAX Settings” screen* on page 37
- 2 Touch **[Flash Pattern]**.
- 3 Touch the item.
 - **Sound1** (default) to **Sound6**:
The flash pattern changes according to the sound level.
Select a desired mode.
 - **L-Pass1** to **L-Pass6**:
The flash pattern changes according to the bass level. Select a desired mode.
 - **Random1**:
The flash pattern changes randomly according to the sound level mode and low pass mode.
 - **Random2**:
The flash pattern changes randomly according to the sound level mode.
 - **Random3**:
The flash pattern changes randomly according to the low pass mode.
 - **Off**:
The flash pattern does not flash.

Displaying the “System” setting screen

- 1 Press **⏏**.
- 2 Touch **[S]**, and then **[M]**.
The “System” setting screen appears.

Setting Bluetooth audio source activation

X7800BT

The default setting is “On”.

- 1 Display the “System” setting screen.
➤ Refer to *Displaying the “System” setting screen* on page 37
- 2 Touch **[AV Source Settings]**.
- 3 Touch **[Bluetooth Audio]** to switch “On” or “Off”.

Setting Spotify source activation

The default setting is “On”.

- 1 Display the “System” setting screen.
➤ Refer to *Displaying the “System” setting screen* on page 37
- 2 Touch **[AV Source Settings]**.
- 3 Touch **[Spotify]** to switch “On” or “Off”.

Setting the ever scroll

When “Ever Scroll” is set to “On”, the recorded text information scrolls continuously in the display while the vehicle is stopped.
The default setting is “Off”.

- 1 Display the “System” setting screen.
➤ Refer to *Displaying the “System” setting screen* on page 37
- 2 Touch **[Ever Scroll]** to switch “On” or “Off”.

System settings

Setting the beep tone

The default setting is "On".

1 Display the "System" setting screen.

- Refer to *Displaying the "System" setting screen* on page 37

2 Touch [Beep Tone] to switch "On" or "Off".

Setting the auto audio mix function

You can select whether or not to use the auto audio mix function. The default setting is "On".

1 Display the "System" setting screen.

- Refer to *Displaying the "System" setting screen* on page 37

2 Touch [Auto Mix] to switch "On" or "Off".

Setting the rear view camera

A separately sold rear view camera (e.g. ND-BC8) is required for utilizing the rear view camera function. (For details, consult your dealer.)

Rear view camera

This product features a function that automatically switches to the full-screen image of the rear view camera installed on your vehicle, when the shift lever is in the REVERSE (R) position.

Camera for Camera View mode

Camera View mode also allows you to check what is behind you while driving.

To display the camera image, touch [Camera View] on the "AV source selection" screen.

- Refer to *Source on the AV source selection screen* on page 13

To set the rear view camera as the camera for **Camera View** mode, set "**Back Camera Input**" to "On".

- Refer to *Setting rear view camera activation* on page 38

⚠CAUTION

Pioneer recommends the use of a camera which outputs mirror reversed images, otherwise the screen image may appear reversed.

- Immediately verify whether the display changes to a rear view camera image when the shift lever is moved to REVERSE (R) from another position.

- When the screen changes to full-screen rear view camera image during normal driving, switch to the opposite setting in "**Camera Polarity**".
- If you touch [⏻] while the camera image is displayed, the displayed image will turn off temporarily.

Setting rear view camera activation

The default setting is "Off".

1 Display the "System" setting screen.

- Refer to *Displaying the "System" setting screen* on page 37

2 Touch [Camera settings].

3 Touch [Back Camera Input] to switch "On" or "Off".

Setting the polarity of the rear view camera

- This function is available when "**Back Camera Input**" is "On".

- Refer to *Setting rear view camera activation* on page 38

1 Display the "System" setting screen.

- Refer to *Displaying the "System" setting screen* on page 37

2 Touch [Camera settings].

3 Touch [Camera Polarity].

- **Battery** (default):
The polarity of the connected lead is positive.
- **Ground**:
The polarity of the connected lead is negative.

Setting the demo mode

The default setting is "On".

1 Display the "System" setting screen.

- Refer to *Displaying the "System" setting screen* on page 37

2 Touch [Demo Mode] to switch "On" or "Off".

Selecting the system language

- If the embedded language and the selected language setting are not the same, text information may not display properly.

- Some characters may not be displayed properly.

1 Display the "System" setting screen.

- Refer to *Displaying the "System" setting screen* on page 37

2 Touch [System Language].

3 Touch the language.

After the language is selected, the previous screen returns.

Setting the keyboard language with the application for iPhone

You can use the keyboard in **AppRadioOne** by setting the language of the keyboard for iPhone.

- This function is only available in **AppRadioOne** on the iPhone.

1 Display the "System" setting screen.

- Refer to *Displaying the "System" setting screen* on page 37

2 Touch [Keyboard].

3 Touch the language.

After the language is selected, the previous screen returns.

Adjusting the response positions of the touch panel (touch panel calibration)

If you feel that the touch panel keys on the screen deviate from the actual positions that respond to your touch, adjust the response positions of the touch panel screen.

- This setting is available only when you stop your vehicle in a safe place and apply the parking brake.
- Do not use sharp pointed tools such as a ballpoint or mechanical pen, which could damage the screen.
- Do not turn off the engine while saving the adjusted position data.

1 Display the "System" setting screen.

- Refer to *Displaying the "System" setting screen* on page 37

2 Touch [Touch panel calibration].

3 Touch [Yes].

System settings

4 **Touch two corners of the screen along the arrows, and then touch the centers of two + marks at the same time twice.**

5 **Press \equiv .**

The adjustment results are saved.

6 **Press \equiv once again.**

Proceed to 16-point adjustment.

7 **Gently touch the center of the “+” mark displayed on the screen.**

The target indicates the order.

- When you press \equiv , the previous adjustment position returns.

- When you press and hold \equiv , the adjustment is canceled.

8 **Press and hold \equiv .**

The adjustment results are saved.

Setting the dimmer

Setting the dimmer trigger

This setting is available only when you stop your vehicle in a safe place and apply the parking brake.

1 **Display the “System” setting screen.**

☞ Refer to *Displaying the “System”* setting screen on page 37

2 **Touch [Dimmer Settings].**

3 **Touch [Dimmer Trigger].**

4 **Touch the item.**

- **Auto** (default):

Switches the dimmer to on or off automatically according to your vehicle’s headlight turning on or off.

- **Manual:**

Switches the dimmer to on or off manually.

- **Time:**

Switches the dimmer to on or off at the time you adjusted.

Setting the dimmer duration in day or night

You can use this function when “Dimmer Trigger” is set to “Manual”.

This setting is available only when you stop your vehicle in a safe place and apply the parking brake.

1 **Display the “System” setting screen.**

☞ Refer to *Displaying the “System”* setting screen on page 37

2 **Touch [Dimmer Settings].**

3 **Touch [Day/Night] to switch the following items.**

- **Day** (default):

Turns the dimmer manually to off.

- **Night:**

Turns the dimmer manually to on.

Setting the dimmer duration optional

You can adjust the time that the dimmer is turned on or off.

You can use this function when “Dimmer Trigger” is set to “Time”.

This setting is available only when you stop your vehicle in a safe place and apply the parking brake.

1 **Display the “System” setting screen.**

☞ Refer to *Displaying the “System”* setting screen on page 37

2 **Touch [Dimmer Settings].**

3 **Touch [Dimmer Duration].**

The “Duration Setting” screen appears.

4 **Drag the cursors to set the dimmer duration.**

- You can also set the dimmer duration touching \leftarrow or \rightarrow .

Each touch of \leftarrow or \rightarrow moves the cursor backward or forward in the 15 minute width.

The default setting is 18:00-6:00 (6:00 PM-6:00 AM).

When the cursors are placed on the same point, the dimmer available time is 0 hours.

When the cursor for off time setting is placed on the left end and the cursor for on time setting is placed on the right end, the dimmer available time is 0 hours.

When the cursor for on time setting is placed on the left end and the cursor for off time setting is placed on the right end, the dimmer available time is 24 hours.

The time display of the dimmer duration adjusting bar is depending on the clock display setting.

☞ Refer to *Setting the time and date* on page 48

Adjusting the picture

You can adjust the picture for each source and rear view camera.

⚠CAUTION

For safety reasons, you cannot use some of these functions while your vehicle is in motion. To enable these functions, you must stop in a safe place and apply the parking brake.

1 **Display the screen you wish to adjust.**

2 **Display the “System” setting screen.**

☞ Refer to *Displaying the “System”* setting screen on page 37

3 **Touch [Picture Adjustment].**

4 **Touch the item to select the function to be adjusted.**

- **Brightness:**

Adjusts the black intensity. (-24 to +24)

- **Contrast:**

Adjusts the contrast. (-24 to +24)

- **Color:**

Adjusts the color saturation. (-24 to +24)

- **Hue:**

Adjusts the tone of color (which color is emphasized, red or green). (-24 to +24)

- **Dimmer:**

Adjusts the brightness of the display. (+1 to +48)

- **Temperature:**

Adjusts the color temperature, resulting in a better white balance. (-3 to +3)

With some pictures, you cannot adjust **Hue** and **Color**.

- When you touch [Rear View], the mode changes to the selected camera mode. By touching [Source], [Nav] or [Apps], you can return to the selected mode.

5 **Touch \leftarrow , \rightarrow , \uparrow , \downarrow to adjust.**

The adjustments of “**Brightness**”, “**Contrast**” and “**Dimmer**” are stored separately when your vehicle’s headlights are off (daytime) and on (nighttime).

“**Brightness**” and “**Contrast**” are switched automatically depending on whether the vehicle’s headlights are on or off.

“**Dimmer**” can be changed the setting or the time to switch it to on or off.

☞ Refer to *Setting the dimmer* on page 39

The picture adjustment may not be available with some rear view cameras.

The setting contents can be memorized separately.

System settings

Displaying the firmware version

1 Display the "System" setting screen.

- ☞ Refer to *Displaying the "System" setting screen* on page 37

2 Touch [System Information].

3 Touch [Firmware Information].

The "Firmware Information" screen appears.

Displaying the open source licenses

1 Display the "System" setting screen.

- ☞ Refer to *Displaying the "System" setting screen* on page 37

2 Touch [System Information].

3 Touch [License].

The open source licenses of the functions that this product is equipped with appear.

Updating firmware

⚠ CAUTION

- The USB storage device for updating must contain only the correct update file.
- Never turn this product off, disconnect the USB storage device while the firmware is being updated.
- You can only update the firmware when the vehicle is stopped and the parking brake is engaged.

1 Download the firmware update files.

2 Connect a blank (formatted) USB storage device to your computer, and then locate the correct update file and copy it onto the USB storage device.

3 Connect the USB storage device to this product.

4 Turn the source off.

- ☞ Refer to *Selecting a source* on page 13

5 Display the "System" setting screen.

- ☞ Refer to *Displaying the "System" setting screen* on page 37

6 Touch [System Information].

7 Touch [Firmware Update].

8 Touch [Continue] to display the data transfer mode.

- Follow the on-screen instructions to finish updating the firmware.
- This product will reset automatically after the firmware update is completed if the update is successful.
- If an error message appears on the screen, touch the display and perform the above steps again.

Audio adjustments

Displaying the "Audio" setting screen

1 Press **⏸**.

2 Touch **[🔊]**, and then **[🔊]**.

The "Audio" setting screen appears.

Using fader/balance adjustment

1 Display the "Audio" setting screen.

- ☞ Refer to *Displaying the "Audio" setting screen* on page 40

2 Touch [Fader/Balance].

- Only the balance can be adjusted when "Network Mode" is selected as the speaker mode. Touch [Balance] and skip to step 4.

3 Touch **[▲]** or **[▼]** to adjust the front/rear speaker balance.

- Set "Front" and "Rear" to "0" when using a dual speaker system.

4 Touch **[◀]** or **[▶]** to adjust the left/right speaker balance.

- You can also set the value by dragging the point on the displayed table.

Switching sound muting/attenuation

You can automatically mute or attenuate the AV source volume and the iPhone application volume when the navigation outputs the guidance voice.

1 Display the "Audio" setting screen.

- ☞ Refer to *Displaying the "Audio" setting screen* on page 40

2 Touch [Mute Level].

3 Touch the item.

- **ATT** (default):
The volume becomes 20 dB lower than the current volume.
- **Mute**:
The volume becomes 0.
- **Off**:
The volume does not change.

Audio adjustments

Adjusting source levels

SLA (source level adjustment) lets you adjust the volume level of each source to prevent radical changes in volume when switching between sources.

- Settings are based on the FM tuner volume level, which remains unchanged.
- This function is not available when the FM tuner is selected as the AV source.

1 Compare the FM tuner volume level with the level of the source.

2 Display the "Audio" setting screen.

- Refer to *Displaying the "Audio"* setting screen on page 40

3 Touch [Source Level Adjuster].

4 Touch or to adjust the source volume.

- If you directly touch the area where the cursor can be moved, the **SLA** setting will be changed to the value of the touched point.
- "+4" to "-4" is displayed as the source volume is increased or decreased.
- The default setting is "0".

Using the auto level control

This function corrects automatically the audio level difference between the music files or the sources.

1 Display the "Audio" setting screen.

- Refer to *Displaying the "Audio"* setting screen on page 40

2 Touch [Automatic Level Control].

3 Touch the item.

- **Off** (default):
Turns the auto level control setting off.
- **Mode1:**
Corrects a little the audio level difference between the music files or the sources (for the narrow dynamic range audio signal).
- **Mode2:**
Corrects widely the audio level difference between the music files or the sources (for the wide dynamic range audio signal).

Adjusting loudness

This function compensates for deficiencies in the low-frequency and high-frequency ranges at low volume.
The default setting is "Off".

- This function is not available while you make or receive a call using the hands-free function.

1 Display the "Audio" setting screen.

- Refer to *Displaying the "Audio"* setting screen on page 40

2 Touch [Loudness].

3 Touch the item.

The following items are available:

Off. Low. Mid. High.

Setting the subwoofer output

This product is equipped with a subwoofer output mechanism, which can be turned on or off.

The default setting is "On".

1 Display the "Audio" setting screen.

- Refer to *Displaying the "Audio"* setting screen on page 40

2 Touch [Subwoofer] to switch "On" or "Off".

Adjusting the cutoff frequency value

You can adjust the cutoff frequency value of each speaker.

The following speakers can be adjusted:

Standard Mode: Front, Rear, Subwoofer.

Network Mode: High, Mid, Subwoofer.

- "Subwoofer Settings" is available only when "Subwoofer" is "On".

- Refer to *Setting the subwoofer output* on page 41

1 Display the "Audio" setting screen.

- Refer to *Displaying the "Audio"* setting screen on page 40

2 Touch [Crossover] or [Subwoofer Settings].

3 Touch or to switch the speaker.

4 Drag the graph line to set the cutoff position.

5 Drag the lowest point of the graph to set the cutoff slope.

- The following items can also be set.

- **Phase** 

Switches the subwoofer phase between normal and reverse position.

- **LPF/HPF:**

Switches the **LPF/HPF** setting to "On" or "Off".

When it is turned off, the high-pass filter or low-pass filter of each speaker can also be turned on by touching the graph lines.

- This function is not available when adjusting the High speaker.

Switching the rear speaker output

- This function is available when "Standard Mode" is selected as the speaker mode.

The default setting is "Rear".

1 Turn the source off.

- Refer to *Selecting a source* on page 13

2 Display the "Audio" setting screen.

- Refer to *Displaying the "Audio"* setting screen on page 40

3 Touch [Rear Speaker Output].

4 Touch to switch "Rear" or "Subwoofer".

Using BASS Boost

1 Display the "Audio" setting screen.

- Refer to *Displaying the "Audio"* setting screen on page 40

2 Touch [BASS Boost].

3 Touch to select the bass boost level from 0 to +6.

Selecting the listening position

You can select a listening position that you want to make as the center of sound effects.

The default setting is "Off".

1 Display the "Audio" setting screen.

- Refer to *Displaying the "Audio"* setting screen on page 40

2 Touch [Listening Position].

3 Touch the desired position to change the listening position.

The following items are available:

Off. Front-L. Front-R. Front. All.

- "All" is not available when "Network Mode" is selected as the speaker mode.

Audio adjustments

Adjusting the speaker output levels finely

Fine adjustments of the speaker output level can be made by listening to audio output.

- This function is available when "Subwoofer" is set to "On".
- Refer to *Setting the subwoofer output* on page 41

1 Display the "Audio" setting screen.

- Refer to *Displaying the "Audio" setting screen* on page 40

2 Touch [Speaker Level].

3 Touch or to select the listening position if necessary.

The following items are available:

Off. Front-L. Front-R. Front. All.

- The default setting is "Off".
- "All" is not available when "Network Mode" is selected as the speaker mode.
- If you change the listening position setting, the output levels of all the speakers will change in conjunction with the setting.

4 Touch or to adjust the speaker output level.

The following speakers are available:

Standard Mode: Front Left, Front Right, Rear Left, Rear Right, Subwoofer

Network Mode: High Left, High Right, Mid Left, Mid Right, Subwoofer

- To use this function, the vehicle's acoustics must be measured in advance.

Adjusting the time alignment

By adjusting the distance from each speaker to the listening position, time alignment is able to correct the time required for sound to reach the listening position.

1 Measure the distance between the head of the listener and each speaker unit.

2 Display the "Audio" setting screen.

- Refer to *Displaying the "Audio" setting screen* on page 40

3 Touch [Time Alignment].

4 Touch or to select the listening position if necessary.

The following items are available:

Off. Front-L. Front-R. Front. All.

- The default setting is "Off".
- "All" is not available when "Network Mode" is selected as the speaker mode.
- If you change the listening position setting, the output levels of all the speakers will change in conjunction with the setting.

5 Touch or to input the distance between the selected speaker and the listening position.

- You can input the value between 0 and 140 inch.

The following speakers are available:

Standard Mode: Front Left, Front Right, Rear Left, Rear Right, Subwoofer

Network Mode: High Left, High Right, Mid Left, Mid Right, Subwoofer

- This function is available only when the listening position setting is set to "Front-L" or "Front-R".
- To use this function, the vehicle's acoustics must be measured in advance.
 - If you touch [TA On], the time alignment is turned off mandatorily.

Switching the time alignment preset

1 Display the "Audio" setting screen.

- Refer to *Displaying the "Audio" setting screen* on page 40

2 Touch [Time Alignment Preset].

3 Touch the item.

- **Initial** (default):
 - Sets to the initial setting value.
- **ATA:**
 - Reflects the result of "A-EQ&TA Measurement" to the setting value.
- **Off:**
 - Resets all setting values to 0.
- **Custom:**
 - Sets to the value adjusted at "Time Alignment".
 - When you adjust the time alignment, the preset item will switch automatically to "Custom".
 - "Custom" can be selected only when the listening position is set to "Front-L" or "Front-R".

Using the equalizer

Recalling equalizer curves

There are seven stored equalizer curves that you can easily recall at any time. Here is a list of the equalizer curves:

- **S.Bass** is a curve in which only low-pitched sound is boosted.
- **Powerful** is a curve in which low- and high-pitched sounds are boosted.
- **Natural** is a curve in which low- and high-pitched sounds are slightly boosted.
- **Vocal** is a curve in which the midrange, which is the human vocal range, is boosted.
- **Flat** is a flat curve in which nothing is boosted.
- **Custom1** is an adjusted equalizer curve that you create. If you select this curve, the effect is applied to all AV sources.
- **Custom2** is an adjusted equalizer curve that you create. If you select this curve, the effect is applied to all AV sources.
- The default setting is "Powerful".

1 Display the "Audio" setting screen.

- Refer to *Displaying the "Audio" setting screen* on page 40

2 Touch [Graphic EQ].

3 Touch the equalizer.

Customizing the equalizer curves

You can adjust the currently selected equalizer curve setting as desired. Adjustments can be made with a 13-band graphic equalizer.

- If you make adjustments when a curve "S.Bass", "Powerful", "Natural", "Vocal", or "Flat" is selected, the equalizer curve settings will be changed to "Custom1" mandatorily.
- If you make adjustments when the "Custom2" curve is selected for example, the "Custom2" curve will be updated.
- "Custom1" and "Custom2" curves can be created common to all sources.

1 Display the "Audio" setting screen.

- Refer to *Displaying the "Audio" setting screen* on page 40

2 Touch [Graphic EQ].

3 Select a curve that you want to use as the basis of customizing.

4 Touch the frequency for which you want to adjust the level.

Audio adjustments

- ❑ If you trail a finger across the bars of multiple equalizer bands, the equalizer curve settings will be set to the value of the touched point on each bar.

Setting the auto-adjusted equalizer

You can set the auto-adjusted equalizer to suit the vehicle's acoustics. To use this function, the vehicle's acoustics must be measured in advance.

The default setting is "Off".

➤ Refer to *Adjusting the equalizer curve automatically (Auto EQ)* on page 43

- ❑ To manually adjust the equalizer curve, set "Auto EQ&TA" to "Off".

1 Display the "Audio" setting screen.

➤ Refer to *Displaying the "Audio" setting screen* on page 40

2 Touch "[Auto EQ&TA] to switch "On" or "Off".

Adjusting the equalizer curve automatically (Auto EQ)

By measuring the vehicle's acoustics, the equalizer curve can be adjusted automatically to suit the vehicle interior.

▲WARNING

A loud tone (noise) may be emitted from the speakers when measuring the vehicle's acoustics. Never perform Auto EQ measurement while driving.

▲CAUTION

- Thoroughly check the conditions before performing Auto EQ, as the speakers may be damaged if this is performed under the following conditions:
 - When the speakers are incorrectly connected. (For example, when a rear speaker is connected as a subwoofer output.)
 - When a speaker is connected to a power amp delivering output higher than the speaker's maximum input power capability.
 - If a microphone for acoustical measurement (sold separately) is not placed in an appropriate location, the measurement tone may become loud and measurement may take a long time, resulting in battery drainage. Be sure to place the microphone in the specified location.

Before operating the Auto EQ function

- Perform Auto EQ in as quiet a place as possible, with the vehicle engine and air conditioning switched off. Also, cut power to car phones or cellular phones in the vehicle, or remove them in advance. Surrounding sounds may prevent correct measurement of the vehicle's acoustics.
- Be sure to use the microphone for acoustical measurement (sold separately). Using another microphone may prevent measurement, or result in incorrect measurement of the vehicle's acoustics.
- To perform Auto EQ, the front speakers must be connected.
- When this product is connected to a power amp with input level control, Auto EQ may be impossible if the power amp's input level is set below the standard level.
- When this product is connected to a power amp with an LPF (low pass filter), turn the LPF off before performing Auto EQ. Also, set the cut-off frequency for the built-in LPF of an active subwoofer to the highest frequency.
- The distance has been calculated by a computer to provide optimum delay to ensure accurate results. Do not change this value.
 - The reflected sound within the vehicle is strong and delays occur.
 - The LPF on active subwoofers or external amps delay the lower sounds.
- If an error occurs during measurement, check the following before measuring the vehicle's acoustics.
 - Front speakers (left/right)
 - Rear speakers (left/right)
 - Noise
 - Microphone for acoustical measurement (sold separately)
 - Low battery

Performing Auto EQ

- ❑ Auto EQ changes the audio settings as follows:
 - The fader/balance settings return to the center position.
- Refer to *Using fader/balance adjustment* on page 40
- "Mute Level" is set to "Off".
- Refer to *Switching sound muting/attenuation* on page 40
- ❑ Previous settings for Auto EQ will be overwritten.

▲CAUTION

Do not turn off the engine while the measurement is in progress.

1 Stop the vehicle in a quiet place, close all the doors, windows and sun roof, and then turn the engine off.

If the engine is left running, engine noise may prevent correct Auto EQ.

- ❑ If driving restrictions are detected during measurement, measurement is canceled.

2 Fix the microphone for acoustical measurement (sold separately) in the center of the headrest of the driver's seat, facing forward.

The Auto EQ may differ depending on where you place the microphone. If desired, place the microphone on the front passenger seat and perform Auto EQ.

3 Disconnect the iPhone or smartphone device.

4 Turn on the ignition switch (ACC ON).

If the vehicle's air conditioner or heater is turned on, turn it off.

5 Switch the AV source to "Source OFF".

➤ Refer to *Selecting a source* on page 13

6 Display the "Audio" setting screen.

➤ Refer to *Displaying the "Audio" setting screen* on page 40

7 Touch [A-EQ&TA Measurement].

The "A-EQ&TA Measurement" screen appears.

8 Connect the microphone for acoustical measurement (sold separately) with this product.

Plug the microphone into the AUX input jack on this product. Use an extension cable (sold separately) if the cord of the Microphone (sold separately) is not long enough.

9 Touch [Front Left] or [Front Right] to select the current listening position.

10 Touch [Start].

A 10-second countdown starts.

- ❑ The Bluetooth connection is disconnected before the process starts.

11 Exit the vehicle and keep the doors closed until the countdown finishes.

When the countdown finishes, a measurement tone (noise) is emitted from the speakers and the Auto EQ measurement begins.

12 Wait until the measurement is completed.

When Auto EQ is completed, a message is displayed.

- ❑ The measurement time varies depending on the type of vehicle.

- To stop the measurement, touch [Stop].

Audio adjustments

13 Store the microphone carefully in the glove compartment or another safe place.

If the microphone is subjected to direct sunlight for an extended period, high temperatures may cause distortion, color change or malfunction.

Saving the sound settings

You can save to recall the following current sound settings: bass boost, slope, subwoofer phase, speaker level, Graphic EQ, HPF/LPF, listening position, crossover, time alignment.

1 Display the "Audio" setting screen.

➤ Refer to *Displaying the "Audio" setting screen* on page 40

2 Touch [Save Settings].

3 Touch [OK].

All of the current sound settings are saved.

- When you touch [Cancel], return to the "Audio" setting screen.

Loading the sound settings

1 Display the "Audio" setting screen.

➤ Refer to *Displaying the "Audio" setting screen* on page 40

2 Touch [Load Settings].

3 Touch the item.

The following items are available:

AEQ Setting, Sound Setting.

- "AEQ Setting" is available only when you have already performed Auto EQ measurement.

➤ Refer to *Adjusting the equalizer curve automatically (Auto EQ)* on page 43

- "Sound Setting" is available only when you have already saved the sound settings.

➤ Refer to *Saving the sound settings* on page 44

Theme menu

Selecting the background display

The background display can be selected from 9 different preset displays for the AV operation screen and 6 different preset displays for the Top menu screen. Furthermore, you can change the background display to other images imported from an USB storage device.

1 Display the "Theme" screen.



2 Touch [Background].

3 Touch [Home] or [AV] to switch the screen displays.

The setting contents can be memorized separately for the AV operation screen and the Top menu screen.

4 Touch the item.

- Preset displays: Selects the desired preset background display.

-  (custom): Displays the background display image imported from the USB storage device.

➤ Refer to *Saving the image as the wallpaper* on page 27

-  (off): Hides the background display.

Setting the illumination color

The illumination color can be selected from 7 different colors. Furthermore, the illumination can be switched between these 7 colors in order.

Selecting the color from the preset colors

You can select an illumination color from the color list.

1 Display the "Theme" screen.



2 Touch [Illumination].

3 Touch the color you want.

- Colored keys: Selects the desired preset color.
-  (custom): Displays the screen to customize the illumination color.

➤ Refer to *Creating a user-defined color* on page 44

-  (rainbow): Shifts gradually between the five default colors in sequence.

- You can preview the Top menu screen or the AV operation screen by touching [Home] or [AV] respectively.

Creating a user-defined color

You can create a user-defined color. The created color is stored, and you can select the color when setting the illumination color the next time.

1 Display the "Theme" screen.

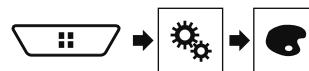

2 Touch [Illumination].

3 Touch the following key.



Displays the screen to create a user-defined color and store it to memory.

4 Touch the following keys.



Adjusts the brightness and the level of red, green and blue to create a favorite color.

- You can also adjust the color tone by dragging the color bar.

5 Touch and hold [Memo] to store the customized color in the memory.

The customized color is stored in the memory.

The set color will be recalled from the memory the next time you touch the same key.

Theme menu

Selecting the theme color

A theme color can be selected from 5 different colors.

1 Display the "Theme" screen.

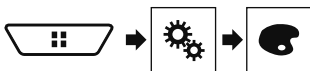

2 Touch [Theme].

3 Touch the color you want.

- You can preview the Top menu screen or the AV operation screen by touching [Home] or [AV] respectively.

Selecting the clock image

The clock on the AV operation screen and the Top menu screen can be selected from 3 different images.

1 Display the "Theme" screen.



2 Touch [Clock].

3 Touch the item.

- Preset images: Selects the desired preset clock image.
- (off): Hides the clock display.

Setting up the video player

Setting the top-priority languages

You can assign the top-priority language to the top-priority subtitle, audio and menu in initial playback. If the selected language is recorded on the disc, subtitles, audio and menu are displayed or output in that language.

- This setting is available when the selected source is "Disc", "CD", "Video CD" or "DVD".

Setting the language

You can set a language preference. When available, the subtitles, audio or menu will be provided in the selected language.

1 Display the "Video Setup" screen.



2 Touch [DVD/DivX Setup].

3 Touch [Subtitle Language], [Audio Language] or [Menu Language].

The pop-up menu appears.

4 Touch the desired language.

When you select "Others", a language code input screen is shown. Input the four-digit code of the desired language then touch .

- If the selected language is not available, the language specified on the disc is displayed.
- You can also switch the language by touching the switch languages key during playback.
- The setting made here will not be affected even if the language is switched during playback using the appropriate key.

Setting the angle icon display

The angle icon can be set so it appears on scenes where the angle can be switched.

- This setting is available when the selected source is "Disc", "CD", "Video CD" or "DVD".

1 Display the "Video Setup" screen.

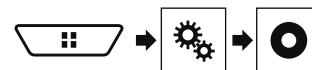

2 Touch [DVD/DivX Setup].

3 Touch [Multi Angle] repeatedly until the desired setting appears.

- On** (default): Turns the multi-angle setting on.
- Off**: Turns the multi-angle setting off.

Setting the aspect ratio

There are two kinds of displays. A wide screen display has a width-to-height ratio (TV aspect) of 16:9, while a regular display has a TV aspect of 4:3. If you use a regular rear display with a TV aspect of 4:3, you can set the aspect ratio suitable for your rear display. (We recommend use of this function only when you want to fit the aspect ratio to the rear display.)

- When using a regular display, select either "Letter Box" or "Pan Scan". Selecting "16:9" may result in an unnatural image.
- If you select the TV aspect ratio, this product's display will change to the same setting.
- This setting is available when the selected source is "Disc", "CD", "Video CD" or "DVD".

1 Display the "Video Setup" screen.



2 Touch [DVD/DivX Setup].

3 Touch [TV Aspect].

The pop-up menu appears.

4 Touch the item.

- 16:9** (default): Displays the wide screen image (16:9) as it is (initial setting).
- Letter Box**: Makes the image in the shape of a letterbox with black bands on the top and bottom of the screen.
- Pan Scan**: Cuts the image short on the right and left sides of the screen.
- When playing discs that do not have a panscan system, the disc is played back with "Letter Box" even if you select the "Pan Scan" setting. Confirm whether the disc package bears the mark.

Setting up the video player

- ❑ The TV aspect ratio cannot be changed for some discs. For details, refer to the disc's instructions.

Setting parental lock

Some DVD-Video discs let you use parental lock to set restrictions so that children cannot watch violent or adult-oriented scenes. You can set the parental lock level in steps as desired.

- ❑ When you set a parental lock level and then play a disc featuring parental lock, code number input indications may be displayed. In this case, playback will begin when the correct code number is input.
- ❑ This setting is available when the selected source is "Disc", "CD", "Video CD" or "DVD".

Setting the code number and level

When you first use this function, register your code number. If you do not register a code number, the parental lock will not operate.

1 Display the "Video Setup" screen.



2 Touch [DVD/DivX Setup].

3 Touch [Parental].

The "Parental" screen appears.

4 Touch [0] to [9] to input a four-digit code number.

5 Touch the following key.



Registers the code number, and you can now set the level.

6 Touch any number between [1] to [8] to select the desired level.

- [8]: Enables playback of the entire disc (initial setting).
- [7] to [2]: Enables playback of discs for children and non-adult oriented discs.
- [1]: Enables only playback of discs for children.

7 Touch the following key.



Sets the parental lock level.

- ❑ We recommend to keep a record of your code number in case you forget it.
- ❑ The parental lock level is recorded on the disc. You can confirm it by looking at the disc package, the included literature or the disc itself. You cannot use parental lock with discs that do not feature a recorded parental lock level.
- ❑ With some discs, parental lock operates to skip certain scenes only, after which normal playback resumes. For details, refer to the disc's instructions.

Displaying your DivX VOD registration code

If you want to play DivX® VOD (video on demand) content on this product, you must first register this product with your DivX VOD content provider. You do this by generating a DivX VOD registration code, which you submit to your provider.

- ❑ Keep a record of the code as you will need it when you register this product to the DivX VOD provider.
- ❑ This setting is available when the selected source is "Disc", "CD", "Video CD" or "DVD".

1 Display the "Video Setup" screen.



2 Touch [DVD/DivX Setup].

3 Touch [DivX® VOD].

The "DivX® VOD" screen appears.

- ❑ If a registration code has already been activated, it cannot be displayed.

4 Touch [Registration Code].

Your 10-digit registration code is displayed.

- ❑ Make a note of the code as you will need it when you deregister from a DivX VOD provider.

Displaying your DivX VOD deregistration code

A registration code registered with a deregistration code can be deleted.

- ❑ This setting is available when the selected source is "Disc", "CD", "Video CD" or "DVD".

1 Display the "Video Setup" screen.

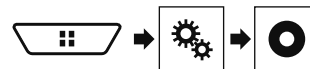

2 Touch [DVD/DivX Setup].

3 Touch [DivX® VOD].

The "DivX® VOD" screen appears.

4 Touch [Deregistration Code].

Your 8-digit deregistration code is displayed.

- ❑ Make a note of the code as you will need it when you deregister from a DivX VOD provider.

Automatic playback of DVDs

When a DVD disc with a DVD menu is inserted, this product will cancel the menu automatically and start playback from the first chapter of the first title.

- ❑ Some DVDs may not operate properly. If this function is not fully operable, turn this function off and start playback.
- ❑ This setting is available when the selected source is "Disc", "CD", "Video CD" or "DVD".

1 Display the "Video Setup" screen.

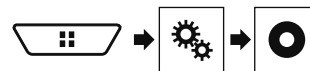

2 Touch [DVD/DivX Setup].

3 Touch [DVD Auto Play] repeatedly until the desired setting appears.

- **Off** (default): Turns the DVD Auto Play setting off
- **On**: Turns the DVD Auto Play setting on

Setting the video signal for the rear view camera

When you connect a rear view camera to this product, select the suitable video signal setting.

- ❑ You can operate this function only for the video signal input into the AV input.

Setting up the video player

1 Display the "Video Setup" screen.



2 Touch [Video Signal Setting].

3 Touch [Camera].

The pop-up menu appears.

4 Touch the item.

- **Auto** (default): Adjusts the video signal setting automatically.
- **PAL**: Sets the video signal to PAL.
- **NTSC**: Sets the video signal to NTSC.
- **PAL-M**: Sets the video signal to PAL-M.
- **PAL-N**: Sets the video signal to PAL-N.
- **SECAM**: Sets the video signal to SECAM.

Favorite menu

Registering your favorite menu items in shortcuts allows you to quickly jump to the registered menu screen by a simple touch on the "Favorites" screen.

- Up to 12 menu items can be registered in the favorite menu.

Creating a shortcut

1 Display the "Settings" screen.

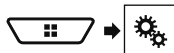

2 Touch the star icon of the menu item.

The star icon for the selected menu is filled in.

- To cancel the registration, touch the star icon in the menu column again.

Selecting a shortcut

1 Display the "Favorites" screen.



2 Touch the desired menu item.

Removing a shortcut

1 Display the "Favorites" screen.



2 Touch the favorite menu column.

The selected menu item is removed from the "Favorites" screen.

- You can also remove a shortcut by touching the star icon in the registered menu column.

Common operations

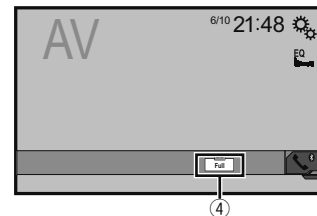
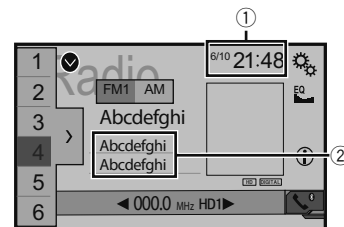



- ① Clock display
Displays the time and date setting screen
➔ Refer to *Setting the time and date* on page 48
- ② Song information
Performs the iTunes Tagging
➔ Refer to *Storing song information to an iPod (iTunes Tagging)* on page 48
- ③ S.Rtrv key
Switches the sound retriever setting

Common operations

- Refer to *Setting the “Sound Retriever”* function on page 48
- ④ Screen display mode key
Changes the wide screen mode
 - Refer to *Changing the wide screen mode* on page 48

Setting the time and date

- 1 Touch the current time on the screen.
- 2 Touch  or  to set the correct time and date.

You can operate the following items: Year, month, date, hour, minute.

- You can change the time display format to “12hour” (default) or “24hour”.
- You can change the order of date display format: Day-month-year, Month-day-year, Year-month-date.

Storing song information to an iPod (iTunes Tagging)



You can store song information to the iPod when this product receives song information. The songs will appear in a playlist called “Tagged playlist” in iTunes the next time you synchronize your iPod. You can directly buy the songs via this product.

- The iTunes Tagging function is available while digital broadcasts are being received.
- This function is available for the following iPod models:
iPhone 3G, 3GS, 4, 4s, 5, 5c, 5s, 6, 6 Plus
iPod touch 1st, 2nd, 3rd, 4th, 5th generation
iPod classic 1st, 2nd generation
iPod nano 3rd, 4th, 5th, 6th generation
- The version of iTunes must be 7.4 or higher.

1 Tune into the broadcast station.

- Refer to *Radio* on page 21

2 Touch the song information.

The information on the song on air is stored in this product. When the information is acquired,  turns off and  is displayed.

- The song information for up to 50 songs can be stored in this product.

3 Connect your iPod.

The song information is transferred to your iPod.



- When your iPod is already connected, the song information will be transferred directly to your iPod every time you touch the song information.

- When the song information transfer is completed, the information stored in this product will be automatically deleted.
- If you turn off this product or disconnect the iPod while transferring song information, the transfer may not successfully complete.
- While this product is storing song information, transfer to an iPod is not possible.

Setting the “Sound Retriever” function

The “Sound Retriever” function automatically enhances compressed audio and restores rich sound.

1 Touch to switch the settings.

-  (Mode1) (default),  (Mode2): Activates the “Sound Retriever” function.
-  (Off): Deactivates the “Sound Retriever” function.
- Mode2 has a stronger effect than Mode1.

Changing the wide screen mode

You can set the screen size for the video and JPEG images.

- The default setting is “Full”, and for JPEG images is “Normal”.
- JPEG can be set to either “Normal” or “Trimming” in wide screen mode.

1 Touch the screen display mode key.

- The appearance of this key changes according to the current setting.

2 Touch the desired mode.

- **Full:**
A 4:3 picture is enlarged in the horizontal direction only, enabling you to enjoy an image without any omissions.
- **Zoom:**
A 4:3 picture is enlarged in the same proportion both vertically and horizontally.
- **Normal:**
A 4:3 picture is displayed normally, without changing its proportion.
- **Trimming**
An image is displayed across the entire screen with the horizontal-to-vertical ratio left as is. If the screen ratio differs from the image, the image may be displayed partly cut off either at the top/bottom or sides.
 - This setting is for JPEG images only.
- You cannot operate this function while driving.

- Different settings can be stored for each video source.
- When a video is viewed in a wide screen mode that does not match its original aspect ratio, it may appear different.
- The video image will appear coarser when viewed in “Zoom” mode.

Other functions

Restoring this product to the default settings

You can restore settings or recorded content to the default settings. Various methods are used to clear user data.

Method 1: Remove the vehicle battery

Resets various settings registered to this product.

- The settings configured on the "Theme" screen are not reset.

Method 2: Restore the default settings from the "System" menu

Method 3: Press the RESET button

- Refer to *Resetting the microprocessor* on page 6

Restoring the default settings

- This setting is available only when you stop your vehicle in a safe place and apply the parking brake.

⚠CAUTION

Do not turn off the engine while restoring the settings.

1 Display the "System" setting screen.



2 Touch [Restore Settings].

A message confirming whether to initialize the settings appears.

3 Touch [Restore].

- The source is turned off and the Bluetooth connection is disconnected before the process starts.

Connection

Precautions

Your new product and this manual

- Do not operate this product, any applications, or the rear view camera option (if purchased) if doing so will divert your attention in any way from the safe operation of your vehicle. Always observe safe driving rules and follow all existing traffic regulations. If you experience difficulty in operating this product or reading the display, park your vehicle in a safe location and apply the parking brake before making the necessary adjustments.
- Do not install this product where it may
 - (i) obstruct the driver's vision,
 - (ii) impair the performance of any of the vehicle's operating systems of safety features, including airbags, hazard lamp buttons, or
 - (iii) impair the driver's ability to safely operate the vehicle.In some cases, it may not be possible to install this product because of the vehicle type or the shape of the vehicle interior.

Important safeguards

⚠WARNING

Pioneer does not recommend that you install this product yourself. This product is designed for professional installation only. We recommend that only authorized Pioneer service personnel, who have special training and experience in mobile electronics, set up and install this product. **NEVER SERVICE THIS PRODUCT YOURSELF.** Installing or servicing this product and its connecting cables may expose you to the risk of electric shock or other hazards, and can cause damage to this product that is not covered by warranty.

Precautions before connecting the system

⚠WARNING

Do not take any steps to tamper with or disable the parking brake interlock system which is in place for your protection. Tampering with or disabling the parking brake interlock system could result in serious injury or death.

⚠CAUTION

- Secure all wiring with cable clamps or electrical tape. Do not allow any bare wiring to remain exposed.
- Do not directly connect the yellow lead of this product to the vehicle battery. If the lead is directly connected to the battery, engine vibration may eventually cause the insulation to fail at the point where the wire passes from the passenger compartment into the engine compartment. If the yellow lead's insulation tears as a result of contact with metal parts, short-circuiting can occur, resulting in considerable danger.
- It is extremely dangerous to allow cables to become wound around the steering column or shift lever. Be sure to install this product, its cables, and wiring away in such so that they will not obstruct or hinder driving.
- Make sure that the cables and wires will not interfere with or become caught in any of the vehicle's moving parts, especially the steering wheel, shift lever, parking brake, sliding seat tracks, doors, or any of the vehicle's controls.
- Do not route wires where they will be exposed to high temperatures. If the insulation heats up, wires may become damaged, resulting in a short circuit or malfunction and permanent damage to the product.
- Do not shorten any leads. If you do, the protection circuit (fuse holder, fuse resistor or filter, etc.) may fail to work properly.
- Never feed power to other electronic products by cutting the insulation of the power supply lead of this product and tapping into the lead. The current capacity of the lead will be exceeded, causing overheating.

Before installing this product

- Use this unit with a 12-volt battery and negative grounding only. Failure to do so may result in a fire or malfunction.
- To avoid shorts in the electrical system, be sure to disconnect the (-) battery cable before installation.

To prevent damage

⚠WARNING

- Use speakers over 50 W (maximum input power) and between 4 Ω to 8 Ω (impedance value). Do not use 1 Ω to 3 Ω speakers for this unit.

Connection

- The black cable is ground. When installing this unit or power amp (sold separately), make sure to connect the ground wire first. Ensure that the ground wire is properly connected to metal parts of the car's body. The ground wire of the power amp and the one of this unit or any other device must be connected to the car separately with different screws. If the screw for the ground wire loosens or falls out, it could result in fire generation of smoke or malfunction.

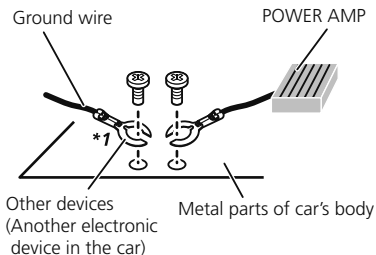

*1 Non supplied for this unit

- When replacing the fuse, be sure to only use a fuse of the rating prescribed on this product.
- This product cannot be installed in a vehicle without ACC (accessory) position on the ignition switch.



ACC position



No ACC position

- To avoid short-circuiting, cover the disconnected lead with insulating tape. It is especially important to insulate all unused speaker leads, which if left uncovered may cause a short circuit.
- For connecting a power amp or other devices to this product, refer to the manual for the product to be connected.

Notice for the blue/white lead

- When the ignition switch is turned on (ACC ON), a control signal is output through the blue/white lead. Connect to an external power amp's system remote control terminal, the auto-antenna relay control terminal, or the antenna booster power control terminal (max. 300 mA 12 V DC). The control signal is output through the blue/white lead, even if the audio source is switched off.

This product

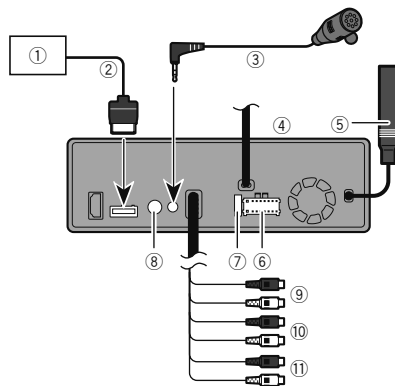

- 1 Pioneer navigation system
Please contact your dealer to inquire about the connectable navigation unit.
- 2 RGB cable(supplied with Navigation system)
- 3 Microphone 4 m (13 ft. 1 in.) (AVH-X7800BT)
- 4 This product
- 5 Antenna jack
- 6 Power supply
- 7 Fuse (10 A)
- 8 Wired remote input
Hard-wired remote control adapter can be connected (sold separately).
- 9 Front output (STD)/High range output (NW)
- 10 Rear output (STD)/Middle range output (NW)
- 11 SubWoofer output (STD)/Low range output (NW)

Power cord

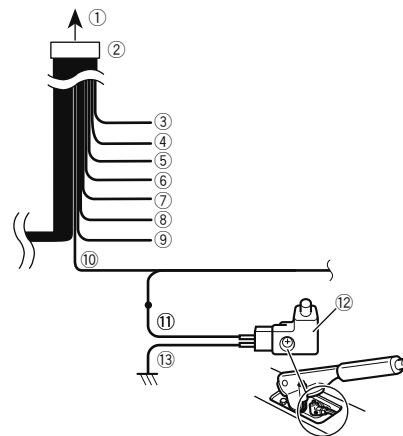

- 1 To power supply
- 2 Power cord
- 3 Yellow
To terminal supplied with power regardless of ignition switch position.
- 4 Red
To electric terminal controlled by ignition switch (12 V DC) ON/OFF.
- 5 Orange/white
To lighting switch terminal.
- 6 Black (ground)
To vehicle (metal) body.
- 7 Violet/white
Of the two lead wires connected to the back lamp, connect the one in which the voltage changes when the gear shift is in the REVERSE (R) position. This connection enables the unit to sense whether the car is moving forwards or backwards.
- 8 Yellow/black
If you use an equipment with Mute function, wire this lead to the Audio Mute lead on that equipment. If not, keep the Audio Mute lead free of any connections.

Connection

- ⑨ Blue/white
Connect to system control terminal of the power amp (max. 300 mA 12 V DC).
- ⑩ Light green
Used to detect the ON/OFF status of the parking brake. This lead must be connected to the power supply side of the parking brake switch.
- ⑪ Power supply side
- ⑫ Parking brake switch
- ⑬ Ground side

Speaker leads

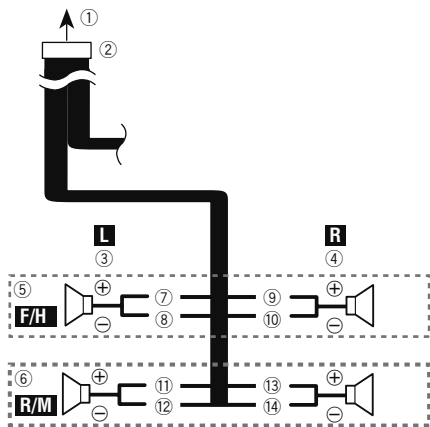

Perform these connections when using a subwoofer without the optional amplifier.

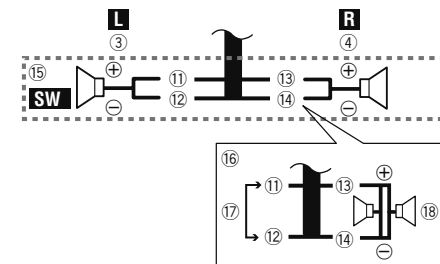

- ① To power supply
- ② Power cord
- ③ Left
- ④ Right
- ⑤ Front speaker (STD) or high range speaker (NW)
- ⑥ Rear speaker (STD) or middle range speaker (NW)
- ⑦ White
- ⑧ White/black
- ⑨ Gray
- ⑩ Gray/black
- ⑪ Green
- ⑫ Green/black
- ⑬ Violet
- ⑭ Violet/black
- ⑮ Subwoofer (4 Ω)
- ⑯ When using a subwoofer of 2 Ω, be sure to connect the subwoofer to the violet and violet/black leads of this unit. Do not connect anything to the green and green/black leads.
- ⑰ Not used.
- ⑱ Subwoofer (4 Ω) × 2
- When a subwoofer is connected to this product instead of a rear speaker, change the rear output setting in the initial setting. The subwoofer output of this product is monaural.
- ➔ Refer to *Switching the rear speaker output* on page 41
- With a two-speaker system, do not connect anything to the speaker leads that are not connected to speakers.

Power amp (sold separately)

Without internal amp

Important

The speaker leads are not used when this connection is in use.

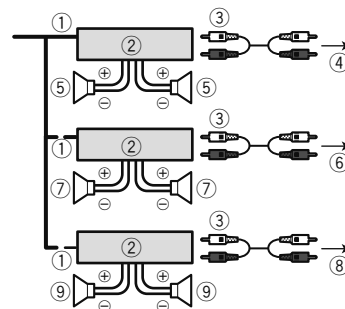

With internal amp

Important

Front speaker and Rear speaker signals (STD) or middle range speaker and high range speaker signals (NW) are output from the speaker leads when this connection is in use.

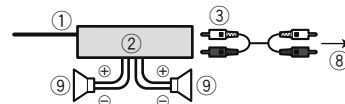

- ① System remote control
Connect to Blue/white cable.
- ② Power amp (sold separately)
- ③ Connect with RCA cable (sold separately)
- ④ To Rear output (STD)
To middle range output (NW)
- ⑤ Rear speaker (STD)
Middle range speaker (NW)

Connection

- ⑥ To Front output (STD)
- To high range output (NW)
- ⑦ Front speaker (STD)
- High range speaker (NW)
- ⑧ To subwoofer output (STD)
- To low range output (NW)
- ⑨ Subwoofer (STD)
- Low range speaker (NW)
- Please select the appropriate speaker mode between standard mode (STD) and network mode (NW).
- ➔ Refer to *On first-time startup* on page 10

iPhone and smartphone

- ➔ For details on how to connect an external device using a separately sold cable, refer to the manual for the cable.
- ➔ For details concerning the connection, operations and compatibility of iPhone, refer to *Setup for iPod / iPhone or smartphone* on page 18.
- ➔ For details concerning the connection and operations of Android device, refer to *Setup for iPod / iPhone or smartphone* on page 18.

iPhone with Lightning connector

Connecting via the USB port

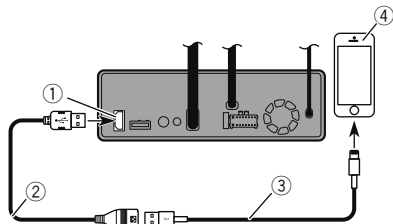

- ① USB port
- ② USB cable 1.5 m (4 ft. 11 in.)
- ③ USB interface cable for iPod / iPhone (CD-IU52) (sold separately)
- ④ iPhone with Lightning connector

iPhone with 30-pin connector

Connecting via the AUX input

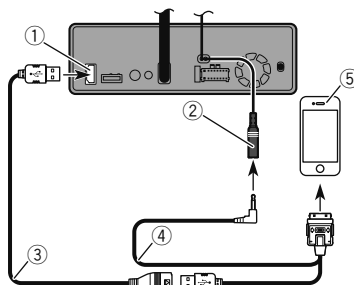

- ① USB port
- ② AUX input
- ③ USB cable 1.5 m (4 ft. 11 in.)
- ④ USB interface cable for iPod / iPhone (CD-IU201V) (sold separately)
- ⑤ iPhone with 30-pin connector

Connecting via the USB port

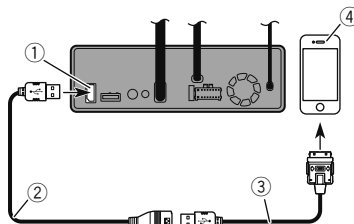

- ① USB port
- ② USB cable 1.5 m (4 ft. 11 in.)
- ③ USB interface cable for iPod / iPhone (CD-IU51) (sold separately)
- ④ iPhone with 30-pin connector

Android device

Connecting via the USB port

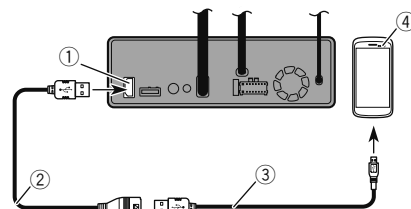

- ① USB port
- ② USB cable (supplied with CD-MU200 (sold separately))
- ③ USB - micro USB cable (Type USB A - micro USB B) (supplied with CD-MU200 (sold separately))
- ④ Android device

Camera

About rear view camera

When you use the rear view camera, the rear view image is automatically switched from the video by moving the shift lever to **REVERSE (R)**. **Camera View** mode also allows you to check what is behind you while driving.

⚠WARNING

USE INPUT ONLY FOR REVERSE OR MIRROR IMAGE REAR VIEW CAMERA. OTHER USE MAY RESULT IN INJURY OR DAMAGE.

⚠CAUTION

- The screen image may appear reversed.
- With the rear view camera you can keep an eye on trailers, or back into a tight parking spot. Do not use for entertainment purposes.
- Objects in rear view may appear closer or more distant than in reality.
- The image area of full-screen images displayed while backing or checking the rear of the vehicle may differ slightly.

Connection

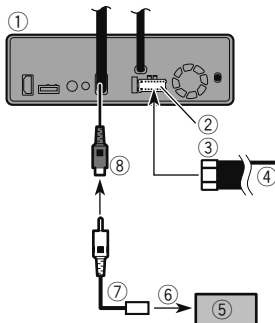

- ① This product
- ② Power supply
- ③ Power cord
- ④ Violet/white (**REVERSE-GEAR SIGNAL INPUT**)
- ➔ Refer to *Power cord* on page 50
- ⑤ Rear view camera (ND-BC8) (sold separately)
- ⑥ To video output
- ⑦ RCA cable (supplied with ND-BC8)
- ⑧ Brown (**REAR VIEW CAMERA IN**)
- Connect only the rear view camera to **REAR VIEW CAMERA IN**. Do not connect any other equipment.
- Some appropriate settings are required to use rear view cameras.
- ➔ Refer to *Setting the rear view camera* on page 38

External video component and the display

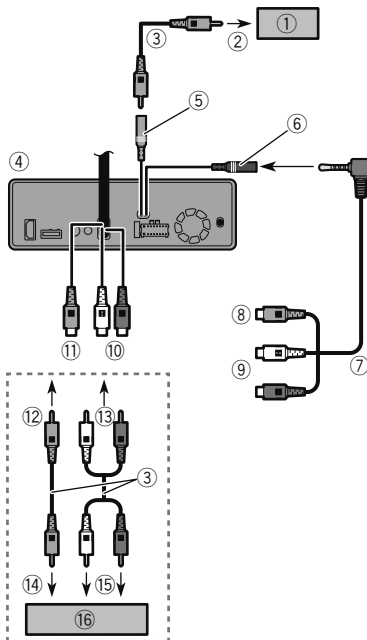

- ① Rear display with RCA input jacks
- ② To video input
- ③ RCA cables (sold separately)
- ④ This product
- ⑤ Yellow (**REAR MONITOR OUTPUT**)
- ⑥ AUX input
- ⑦ Mini-jack AV cable (CD-RM10) (sold separately)
- ⑧ Yellow
- ⑨ Red, white
- ⑩ Red, white (**AUDIO INPUT**)
- ⑪ Yellow (**VIDEO INPUT**)

- ⑫ To Yellow
- ⑬ To Red, white
- ⑭ To video output
- ⑮ To audio outputs
- ⑯ External video component (sold separately)
- The appropriate setting is required to use the external video component.
- ➔ Refer to *AV input* on page 36

⚠ WARNING

NEVER install the rear display in a location that enables the driver to watch the video source while driving.

This product's rear video output is for connection of a display to enable passengers in the rear seats to watch the video source.

Installation

Precautions before installation

⚠ CAUTION

Never install this product in places where, or in a manner that:

- Could injure the driver or passengers if the vehicle stops suddenly.
- May interfere with the driver's operation of the vehicle, such as on the floor in front of the driver's seat, or close to the steering wheel or shift lever.
- To ensure proper installation, be sure to use the supplied parts in the manner specified. If any parts are not supplied with this product, use compatible parts in the manner specified after you have the parts' compatibility checked by your dealer. If parts other than supplied or compatible ones are used, they may damage internal parts of this product or they may work loose and the product may become detached.
- Do not install this product where it may
 - (i) obstruct the driver's vision,
 - (ii) impair the performance of any of the vehicle's operating systems or safety features, including airbags, hazard lamp buttons or
 - (iii) impair the driver's ability to safely operate the vehicle.
- Never install this product in front of or next to the place in the dashboard, door, or pillar from which one of your vehicle's airbags would deploy. Please refer to your vehicle's owner's manual for reference to the deployment area of the frontal airbags.

Before installing

- Consult with your nearest dealer if installation requires drilling holes or other modifications of the vehicle.
- Before making a final installation of this product, temporarily connect the wiring to confirm that the connections are correct and the system works properly.

Installation notes

- Do not install this product in places subject to high temperatures or humidity, such as:
 - Places close to a heater, vent or air conditioner.
 - Places exposed to direct sunlight, such as on top of the dashboard.
 - Places that may be exposed to rain, such as close to the door or on the vehicle's floor.

- Install this product horizontally on a surface within 0 to 30 degrees tolerance (within 5 degrees to the left or right). Improper installation of the unit with the surface tilted more than these tolerances increases the potential for errors in the vehicle's location display, and might otherwise cause reduced display performance.

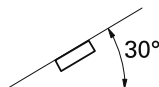

- When installing, to ensure proper heat dispersal when using this unit, make sure you leave ample space behind the rear panel and wrap any loose cables so they are not blocking the vents.

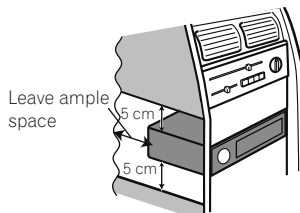

- The cords must not cover up the area shown in the figure below. This is necessary to allow the amplifiers to radiate freely.

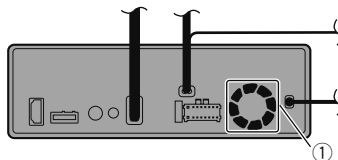

- ① Do not cover this area.
- Make sure you leave enough gap between the dashboard and the LCD panel of this unit so the LCD panel can be opened and closed without contacting with the dashboard.

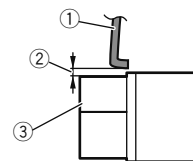

- ① Dashboard
- ② Sleeve
- ③ LCD panel

DIN front/rear-mount

This unit can be properly installed using either front-mount or rear-mount installation. Use commercially available parts when installing.

DIN Front-mount

1 Decide the position of the side brackets.

When installing in a shallow space, change the position of side brackets (small).

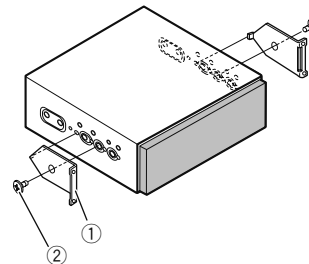

- ① Side bracket (small)
- ② Flush surface screw (5 mm × 6 mm)

2 Install the unit into the dashboard.

Insert the mounting sleeve into the dashboard. And then secure the mounting sleeve by using a screwdriver to bend the metal tabs (90°) into place.

Installation

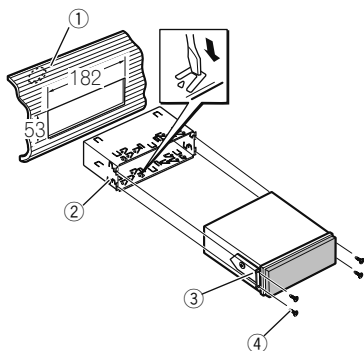

- ① Dashboard
- ② Mounting sleeve
- ③ Side bracket
- ④ Screw (2 mm × 3 mm)

DIN Rear-mount

1 Determine the appropriate position where the holes on the bracket and the side of the unit match.

When installing in a shallow space, use the following screw holes.

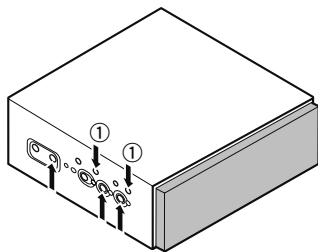

- ① Use binding screws (4 mm × 3 mm) only.
- 2 Tighten two screws on each side.

Use any of binding screws (4 mm × 3 mm), binding screws (5 mm × 6 mm) or flush surface screws (5 mm × 6 mm), depending on the shape of screw holes in the bracket.

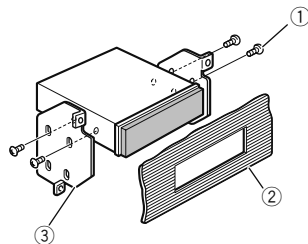

- ① Screw
- ② Dashboard or console
- ③ Factory radio mounting bracket
- In some types of vehicles, discrepancy may occur between the unit and the dashboard. If this happens, use the supplied frame to fill the gap.

Removing the unit

Extend top and bottom of the trim ring outwards to remove the trim ring. And then loosen the screws (2 mm × 3 mm) to remove the mounting sleeve.

- When reattaching the trim ring, push the trim ring onto the unit until it clicks. (If the trim ring is attached upside down, the trim ring will not fit properly.)

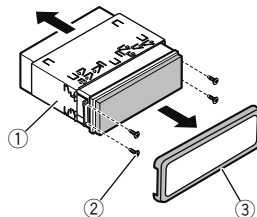

- ① Mounting sleeve
- ② Screw (2 mm × 3 mm)
- ③ Trim ring

Fastening the front panel

If you do not plan to detach the front panel, the front panel can be fastened with supplied screw.

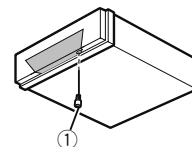

- ① Screw

Installing the microphone

X7800BT

- Install the microphone in a place where its direction and distance from the driver make it easiest to pick up the driver's voice.
- Be sure to turn off (ACC OFF) the product before connecting the microphone.

Mounting on the sun visor

1 Fit the microphone lead into the groove.

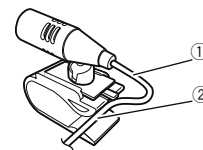

- ① Microphone lead
- ② Groove

2 Attach the microphone clip to the sun visor.

Installation

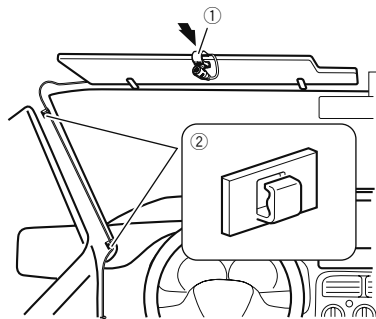

- ① Microphone clip
- ② Clamps
Use separately sold clamps to secure the lead where necessary inside the vehicle.

Install the microphone on the sun visor when it is in the up position. It cannot recognize the driver's voice if the sun visor is in the down position.

Installation on the steering column

- 1 Detach the microphone base from the microphone clip by sliding the microphone base while pressing the tab.

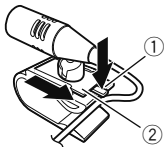

- ① Tab
- ② Microphone base

- 2 Mount the microphone on the steering column.

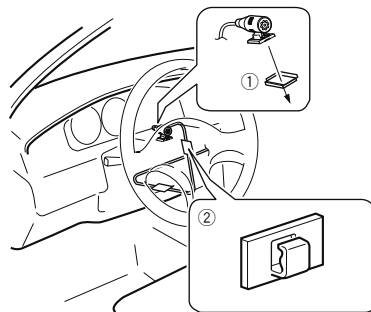

- ① Double-sided tape
- ② Clamps
Use separately sold clamps to secure the lead where necessary inside the vehicle.

- 3 Keeping it away from the steering wheel.

Adjusting the microphone angle



Appendix

Troubleshooting

If you have problems operating this product, refer to this section. The most common problems are listed below, along with likely causes and solutions. If a solution to your problem cannot be found here, contact your dealer or the nearest authorized Pioneer service facility.

Common problems

A black screen is displayed, and operation is not possible using the touch panel keys.

- "Power OFF" mode is on.
 - Press any button on this product to release the mode.

Problems with the AV screen

CD or DVD playback is not possible.

- The disc is inserted upside down.
 - Insert the disc with the label upward.
- The disc is dirty.
 - Clean the disc.
- The disc is cracked or otherwise damaged.
 - Insert a normal, round disc.
- The files on the disc are in an irregular file format.
 - Check the file format.
- The disc format cannot be played back.
 - Replace the disc.
- The loaded disc is a type this product cannot play.
 - Check what type of disc it is.

The screen is covered by a caution message and the video cannot be shown.

- The parking brake lead is not connected or applied.
 - Connect the parking brake lead correctly, and apply the parking brake.
- The parking brake interlock is activated.
 - Park your vehicle in a safe place and apply the parking brake.

No video output from the connected equipment.

- The "AV Input" or "AUX Input" setting is incorrect.
 - Correct the settings.

The audio or video skips.

- This product is not firmly secured.
 - Secure this product firmly.

Appendix

No sounds are produced. The volume level will not rise.

- Cables are not connected correctly.
 - Connect the cables correctly.
- The system is performing still, slow motion, or frame-by-frame playback with DVD-Video.
 - There is no sound during still, slow motion, or frame-by-frame playback with DVD-Video.
- The system is paused or performing, fast reverse or forward during the disc playback.
 - For the media other than music CD (CD-DA), there is no sound on fast reverse or forward.

The icon is displayed, and operation is impossible.

- The operation is not compatible with the video configuration.
 - This operation is not possible. (For example, the DVD playing does not feature that angle, audio system, subtitle language, etc.)

The picture stops (pauses) and this product cannot be operated.

- The reading of data is impossible during disc playback.
 - Stop playback once, then restart.

The picture is stretched, with an incorrect aspect ratio.

- The aspect setting is incorrect for the display.
 - Select the appropriate setting for that image.

A parental lock message is displayed and DVD playback is not possible.

- The parental lock is on.
 - Turn the parental lock off or change the level.

The parental lock for DVD playback cannot be canceled.

- The code number is incorrect.
 - Input the correct code number.

Playback is not with the audio language and subtitle language settings selected in "DVD/DivX Setup".

- The DVD playing does not feature dialog or subtitles in the language selected in "DVD/DivX Setup".
 - Switching to a selected language is not possible if the language selected in "DVD/DivX Setup" is not recorded on the disc.

The picture is extremely unclear/distorted and dark during playback.

- The disc features a signal to prohibit copying. (Some discs may have this.)
 - Since this product is compatible with the copy guard analog copy protect system, the picture may suffer from horizontal stripes or other imperfections when a disc with that kind of protection signal is viewed on some displays. This is not a malfunction.

iPod cannot be operated.

- The iPod is frozen.
 - Reconnect the iPod with the USB interface cable for iPod/iPhone.
 - Update the iPod software version.
- An error has occurred.
 - Reconnect the iPod with the USB interface cable for iPod/iPhone.
 - Park your vehicle in a safe place, and turn off the engine. Turn the ignition key back to off (ACC OFF). Then restart the engine, and turn the power to this product back on.
 - Update the iPod software version.
- Cables are not connected correctly.
 - Connect the cables correctly.

Sound from the iPod cannot be heard.

- The audio output direction may switch automatically when the Bluetooth and USB connections are used at the same time.
 - Use the iPod to change the audio output direction.

Problems with the phone screen

Dialing is impossible because the touch panel keys for dialing are inactive.

- Your phone is out of range for service.
 - Retry after re-entering the range for service.
- The connection between the cellular phone and this product cannot be established now.
 - Perform the connection process.
- Of the two cellular phones connected to this product at the same time, if the first phone is dialing, ringing or a call is in progress, dialing cannot be performed on the second phone.
 - When the operation on the first of the two cellular phones is completed, use the switch devices key to switch to the second phone and then dial.

Problems with the Application screen

A black screen is displayed.

- While operating an application, the application was ended on the smartphone side.
 - Press  to display the Top menu screen.
- The smartphone OS may be awaiting screen operation.
 - Stop the vehicle in a safe place and check the screen on the smartphone.

The screen is displayed, but operation does not work at all.

- An error has occurred.
 - Park your vehicle in a safe place, and then turn off the ignition switch (ACC OFF). Subsequently, turn the ignition switch to on (ACC ON) again.
 - When an Android device is connected, disconnect the Bluetooth connection from this product and then reconnect it.

The smartphone was not charged.

- Charging stopped because the temperature of the smartphone rose due to prolonged use of the smartphone during charging.
 - Disconnect the smartphone from the cable, and wait until the smartphone cools down.
- More battery power was consumed than was gained from charging.
 - This problem may be resolved by stopping any unnecessary services on the smartphone.

Error messages

When problems occur with this product, an error message appears on the display. Refer to the table below to identify the problem, then take the suggested corrective action. If the error persists, record the error message and contact your dealer or your nearest Pioneer service center.

Common

AMP Error

- This product fails to operate or the speaker connection is incorrect; the protective circuit is activated.
 - Check the speaker connection. If the message fails to disappear even after the engine is switched off/on, contact your dealer or an authorized Pioneer Service Station for assistance.

Product overheat. System will be shut down automatically in 1 minute. Restart the product by ACC Off/On may fix this problem. If this message keep showing up, it is possible that some problem occurred in the product.

- The temperature is too high for this product to operate.
 - Follow the instructions displayed on the screen. If this does not solve the problem, contact your dealer or an authorized Pioneer Station for assistance.

Pandora

Error-19

- Communication failed.
 - Disconnect the cable from the iPod. Once the iPod's main menu is displayed, reconnect the iPod and reset it.

Skip limit reached.

- Skip limit reached.
 - Do not exceed the skip limit.
 - Pandora limits the total number of skips per hour.

Check Device

- You are not logged in to the Pandora application.
 - Please log in to the Pandora application.

Incompatible USB

- The connected USB storage device is not supported by this product.
 - Disconnect your device and replace it with a compatible USB storage device.

Check USB

- The USB connector or USB cable has short-circuited.
 - Check that the USB connector or USB cable is not caught in something or damaged.
- The connected USB storage device consumes more than maximum allowable current.
 - Disconnect the USB storage device and do not use it. Turn the ignition switch to OFF, then to ACC or ON and then connect a compliant USB storage device.

Cannot play music due to licensing restrictions.

- The Pandora application is accessed/relocated from outside the licensing region.
 - Access Pandora from within the licensing region.

Spotify

Skip limit reached.

- Skip limit reached.
 - Do not exceed the skip limit.
 - Spotify limits the total number of skips per hour.

Check USB

- The USB connector or USB cable has short-circuited.
 - Check that the USB connector or USB cable is not caught in something or damaged.
- The connected USB storage device consumes more than maximum allowable current.
 - Disconnect the USB storage device and do not use it. Turn the ignition switch to OFF, then to ACC or ON and then connect a compliant USB storage device.

Disc

Error-02-XX/FF-FF

- The disc is dirty.
 - Clean the disc.
- The disc is scratched.
 - Replace the disc.
- The disc is loaded upside down.
 - Check that the disc is loaded correctly.
- There is an electrical or mechanical error.
 - Press the **RESET** button.

Different Region Disc

- The disc does not have the same region number as this product.
 - Replace the DVD with one bearing the correct region number.

Unplayable Disc

- This type of disc cannot be played on this product.
 - Replace the disc with one that can be played on this product.

Unplayable File

- This type of file cannot be played on this product.
 - Select a file that can be played.

Skipped

- The inserted disc contains DRM protected files.
 - The protected files are skipped.

Protect

- All the files on the inserted disc are embedded with DRM.
 - Replace the disc.

TEMP

- The temperature of this product is outside the normal operating range.
 - Wait until this product returns to a temperature within the normal operating limits.

This DivX rental has expired.

- The inserted disc contains expired DivX VOD content.
 - Select a file that can be played.

Video resolution not supported

- Files that cannot be played on this product are included in the file.
 - Select a file that can be played.

Unable to write to flash memory.

- The playback history for VOD contents cannot be saved for some reason.
 - Retry.
 - If the message appears frequently, consult your dealer.

Your device is not authorized to play this DivX protected video.

- This product's DivX registration code has not been authorized by the DivX VOD contents provider.
 - Register this product to the DivX VOD contents provider.

Video frame rate not supported

- DivX file's frame rate is more than 30 fps.
 - Select a file that can be played.

Audio Format not supported

- This type of file is not supported on this product.
 - Select a file that can be played.

USB storage device

Error-02-9X/-DX

- Communication failed.
 - Turn the ignition switch OFF and back ON.
 - Disconnect the USB storage device.
 - Change to a different source. Then, return to the USB storage device.

Unplayable File

- This type of file cannot be played on this product.
 - Select a file that can be played.
- Security for the connected USB storage device is enabled.
 - Follow the USB storage device instructions to disable security.

Skipped

- The connected USB storage device contains DRM protected files.
 - The protected files are skipped.

Protect

- All the files on the connected USB storage device are embedded with DRM.
 - Replace the USB storage device.

Incompatible USB

- The connected USB storage device is not supported by this product.
 - Disconnect your device and replace it with a compatible USB storage device.

Check USB

- The USB connector or USB cable is short-circuited.
 - Check that the USB connector or USB cable is not caught in something or damaged.
- The connected USB storage device consumes more than maximum allowable current.
 - Disconnect the USB storage device and do not use it. Turn the ignition switch to OFF, then to ACC or ON and then connect a compliant USB storage device.

Appendix

HUB Error

- The connected USB hub is not supported by this product.
 - Directly connect the USB storage device to this product.

No Response

- This product cannot recognize the connected USB storage device.
 - Disconnect the device and replace it with another USB storage device.

Video resolution not supported

- Files that cannot be played on this product are included in the file.
 - Select a file that can be played.

USB was disconnected for device protection. Do not reinsert this USB memory into the unit. Please restart the unit.

- The USB connector or USB cable is short-circuited.
 - Check that the USB connector or USB cable is not caught in something or damaged.
- The connected USB storage device consumes more than maximum allowable current.
 - Disconnect the USB storage device and do not use it. Turn the ignition switch to OFF, then to ACC or ON and then connect a compliant USB storage device.
- The USB interface cable for iPod / iPhone is short-circuited.
 - Confirm that the USB interface cable for iPod / iPhone or USB cable is not caught in something or damaged.

Audio Format not supported

- This type of file is not supported on this product.
 - Select a file that can be played.

iPod

Error-02-6X/-9X/-DX

- iPod failure.
 - Disconnect the cable from the iPod. Once the iPod's main menu is displayed, reconnect the iPod and reset it.

Error-02-67

- The iPod firmware version is old.
 - Update the iPod version.

iTunes tagging

Error-8D

- Built-in FLASH ROM encountered an error.
 - Turn the ignition switch to OFF and then to ON.

Tag store failed.

- Tag information cannot be stored in this product.
 - Try again.

Already stored.

- This tag information is already stored in memory.
 - Tag information can only be saved once for any given song. Tag information cannot be saved for the same song more than once.

Memory full. Connect iPod.

- The tag information is successfully stored. The flash memory of this product has become full.
 - The tag information on this product is transferred to the iPod automatically when an iPod is connected.

Memory full. Tags not stored. Connect iPod.

- This product's flash memory used as the temporary storage area is full.
 - The tag information on this product is transferred to the iPod automatically when an iPod is connected.

iPod full. Tags not transferred.

- Memory used for tag information on the iPod is full.
 - Sync the iPod with iTunes and clean up the tagged playlist.

Tag transfer failed. Reconnect your iPod.

- This product's tag information cannot transfer to the iPod.
 - Check the iPod and try again.

Bluetooth

Error-10

- The power failed for the Bluetooth module of this product.
 - Turn the ignition switch to OFF and then to ON. If the error message is still displayed after performing the above action, please contact your dealer or an authorized Pioneer Service Station.

Handling and care of discs

Some basic precautions are necessary when handling your discs.

Built-in drive and care

- Use only conventional, fully circular discs. Do not use shaped discs.
- Do not use cracked, chipped, warped, or otherwise damaged discs as they may damage the built-in drive.
- Use 12-cm discs. Do not use 8-cm discs or an adapter for 8-cm discs.
- When using discs that can be printed on label surfaces, check the instructions and the warnings of the discs. Depending on the discs, inserting and ejecting may not be

possible. Using such discs may result in damage to this equipment.

- Do not attach labels, write on or apply chemicals to the surface of the discs.
- Do not attach commercially available labels or other materials to the discs.
- To clean a disc, wipe it with a soft cloth, moving outward from the center.
- Condensation may temporarily impair the built-in drive's performance.
- Playback of discs may not be possible because of disc characteristics, disc format, recorded application, playback environment, storage conditions and so on.
- Road shocks may interrupt disc playback.
- Read the precautions for discs before using them.

Ambient conditions for playing a disc

- At extremely high temperatures, a temperature cutout protects this product by switching it off automatically.
- Despite our careful design of the product, small scratches that do not affect actual operation may appear on the disc surface as a result of mechanical wear, ambient conditions for use or handling of the disc. This is not a sign of the malfunction of this product. Consider it to be normal wear and tear.

Playable discs

DVD-Video



- **DVD** is a trademark of DVD Format/Logo Licensing Corporation.
- It is not possible to play DVD-Audio discs. This DVD drive may not be able to play all discs bearing the marks shown above.

CD



AVCHD recorded discs

This unit is not compatible with discs recorded in AVCHD (Advanced Video Codec High Definition) format. Do not insert AVCHD discs. If inserted, the disc may not be ejected.

Playing DualDisc

- DualDiscs are two-sided discs that have a recordable CD for audio on one side and a recordable DVD for video on the other.
- Playback of the DVD side is possible with this product. However, since the CD side of DualDiscs is not physically compatible with the general CD standard, it may not be possible to play the CD side with this product.
- Frequent loading and ejecting of a DualDisc may result in scratches to the disc.
- Serious scratches can lead to playback problems on this product. In some cases, a DualDisc may become stuck in the disc-loading slot and will not eject. To prevent this, we recommend you refrain from using DualDisc with this product.
- Please refer to the manufacturer for more detailed information about DualDiscs.

Dolby Digital

This product will down-mix Dolby Digital signals internally and the sound will be output in stereo.

- ☐ Manufactured under license from Dolby Laboratories. Dolby and the double-D symbol are trademarks of Dolby Laboratories.

Detailed information for playable media

Compatibility

Common notes about disc compatibility

- Certain functions of this product may not be available for some discs.
- Compatibility with all discs is not guaranteed.
- It is not possible to playback DVD-ROM/DVD-RAM discs.
- Playback of discs may become impossible with direct exposure to sunlight, high temperatures, or depending on the storage conditions in the vehicle.

DVD-Video discs

- DVD-Video discs that have incompatible region numbers cannot be played on this DVD drive. The region number of the player can be found on this product's chassis.

DVD-R/DVD-RW/DVD-R SL (Single Layer)/DVD-R DL (Dual Layer) discs

- Unfinalized discs which have been recorded with the Video format (video mode) cannot be played back.
- Discs which have been recorded with the Video Recording format (VR mode) cannot be played back.
- DVD-R DL (Dual Layer) discs which have been recorded with Layer Jump recording cannot be played back.
- For detailed information about recording mode, please contact the manufacturer of media, recorders, or writing software.

CD-R/CD-RW discs

- Unfinalized discs cannot be played back.
- It may not be possible to playback CD-R/CD-RW discs recorded on a music CD recorder or a computer because

of disc characteristics, scratches or dirt on the disc, or dirt, scratches or condensation on the lens of the built-in drive.

- Playback of discs recorded on a computer may not be possible, depending on the recording device, writing software, their settings, and other environmental factors.
- Please record with the correct format. (For details, please contact manufacturer of media, recorders, or writing software.)
- Titles and other text information recorded on a CD-R/CD-RW disc may not be displayed by this product (in the case of audio data (CD-DA)).
- Read the precautions with CD-R/CD-RW discs before using them.

Common notes about the USB storage device

- Do not leave the USB storage device in any location with high temperatures.
- Depending on the kind of the USB storage device you use, this product may not recognize the storage device or files may not be played back properly.
- The text information of some audio and video files may not be correctly displayed.
- File extensions must be used properly.
- There may be a slight delay when starting playback of files on an USB storage device with complex folder hierarchies.
- Operations may vary depending on the kind of an USB storage device.
- It may not be possible to play some music files from USB because of file characteristics, file format, recorded application, playback environment, storage conditions, and so on.

USB storage device compatibility

- ☞ For details about USB storage device compatibility with this product, refer to *Specifications* on page 65.
 - Protocol: bulk
 - You cannot connect a USB storage device to this product via a USB hub.
 - Partitioned USB storage device is not compatible with this product.
 - Firmly secure the USB storage device when driving. Do not let the USB storage device fall onto the floor, where it may become jammed under the brake or gas pedal.
 - There may be a slight delay when starting playback of audio files encoded with image data.
 - Some USB storage devices connected to this product may generate noise on the radio.
 - Do not connect anything other than the USB storage device.
- The sequence of audio files on USB storage device
For USB storage device, the sequence is different from that of USB storage device.

Handling guidelines and supplemental information

- This product is not compatible with the Multi Media Card (MMC).
- Copyright protected files cannot be played back.

Common notes about DivX files

Notes specific to DivX files

- Only DivX files downloaded from DivX partner sites are guaranteed for proper operation. Unauthorized DivX files may not operate properly.
- DRM rental files cannot be operated until playing back is started.
- This product corresponds to a DivX file display of up to 1 590 minutes 43 seconds. Search operations beyond this time limit are prohibited.
- DivX VOD file playback requires supplying the ID code of this product to the DivX VOD provider. Regarding the ID code, refer to *Displaying your DivX VOD registration code* on page 46.
- For details on the DivX video versions that can be played on this product, refer to *Specifications* on page 65.
- For more details about DivX, visit the following site: <http://www.divx.com/>

DivX subtitle files

- Srt format subtitle files with the extension ".srt" can be used.
- Only one subtitle file can be used for each DivX file. Multiple subtitle files cannot be associated.
- Subtitle files that are named with the same character string as the DivX file before the extension are associated with the DivX file. The character strings before the extension must be exactly the same. However, if there is only one DivX file and one subtitle file in a single folder, the files are associated even if the file names are not the same.
- The subtitle file must be stored in the same folder as the DivX file.
- Up to 255 subtitle files may be used. Any more subtitle files will not be recognized.
- Up to 64 characters can be used for the name of the subtitle file, including the extension. If more than 64 characters are used for the file name, the subtitle file may not be recognized.
- The character code for the subtitle file should comply with ISO-8859-1. Using characters other than ISO-8859-1 may cause the characters to be displayed incorrectly.
- The subtitles may not be displayed correctly if the displayed characters in the subtitle file include control code.
- For materials that use a high transfer rate, the subtitles and video may not be completely synchronized.

- If multiple subtitles are programmed to display within a very short time frame, such as 0.1 seconds, the subtitles may not be displayed at the correct time.

Media compatibility chart

General

- Maximum playback time of audio file stored in the disc: 60 h
- Maximum playback time of audio file stored on a USB storage device: 7.5 h (450 minutes)

CD-R/RW

File system: ISO9660 level 1.ISO9660 level 2.Romeo, Joliet.UDF 1.02/1.50/2.00/2.01/2.50
Maximum number of folders: 700
Maximum number of files: 999
Playable file types: MP3, WMA, AAC, DivX, MPEG1, MPEG2, MPEG4

DVD-R/R SL/-R DL/ DVD-RW

File system: ISO9660 level 1.ISO9660 level 2.Romeo, Joliet.UDF 1.02/1.50/2.00/2.01/2.50
Maximum number of folders: 700
Maximum number of files: 3 500
Playable file types: MP3, WMA, AAC, DivX, MPEG1, MPEG2, MPEG4

USB storage device

File system: FAT16/FAT32
Maximum number of folders: 1 500
Maximum number of files: 15 000
Playable file types: MP3, WMA, AAC, WAV, FLAC, H.264, MPEG4, JPEG

MP3 compatibility

- Ver. 2.x of ID3 tag is prioritized when both Ver. 1.x and Ver. 2.x exist.
- This product is not compatible with the following: MP3i (MP3 interactive), mp3 PRO, m3u playlist

CD-R/RW

File extension: .mp3
Bit rate: 8 kbps to 320 kbps (CBR), VBR
Sampling frequency: 16 kHz to 48 kHz (32 kHz, 44.1 kHz, 48 kHz for emphasis)
ID3 tag: ID3 tag Ver. 1.0, 1.1, 2.2, 2.3

DVD-R/-R SL/-R DL/ DVD-RW

File extension: .mp3
Bit rate: 8 kbps to 320 kbps (CBR), VBR

Sampling frequency: 16 kHz to 48 kHz (32 kHz, 44.1 kHz, 48 kHz for emphasis)
ID3 tag: ID3 tag Ver. 1.0, 1.1, 2.2, 2.3

USB storage device

File extension: .mp3
Bit rate: 8 kbps to 320 kbps (CBR), VBR
Sampling frequency: 8 kHz to 48 kHz
ID3 tag: ID3 tag Ver. 1.0, 1.1, 2.2, 2.3, 2.4

WMA compatibility

- This product is not compatible with the following: Windows Media™ Audio 9 Professional, Lossless, Voice

CD-R/-RW

File extension: .wma
Bit rate: 5 kbps to 320 kbps (CBR), VBR
Sampling frequency: 8 kHz to 48 kHz

DVD-R/-R SL/-R DL/ DVD-RW

File extension: .wma
Bit rate: 5 kbps to 320 kbps (CBR), VBR
Sampling frequency: 8 kHz to 48 kHz

USB storage device

File extension: .wma
Bit rate: 5 kbps to 320 kbps (CBR), VBR
Sampling frequency: 8 kHz to 48 kHz

WAV compatibility

- The sampling frequency shown in the display may be rounded.
- WAV files on the CD-R/-RW, DVD-R/-RW/-R SL/-R DL cannot be played.

USB storage device

File extension: .wav
Format: Linear PCM (LPCM)
Sampling frequency: 16 kHz to 48 kHz
Quantization bits: 8 bits and 16 bits

AAC compatibility

- This product plays back AAC files encoded by iTunes.

CD-R/-RW

File extension: .m4a
Bit rate: 8 kbps to 320 kbps (CBR)
Sampling frequency: 8 kHz to 44.1 kHz

DVD-R/-R SL/-R DL/ DVD-RW

File extension: .m4a
Bit rate: 8 kbps to 320 kbps (CBR)
Sampling frequency: 8 kHz to 44.1 kHz

USB storage device

File extension: .m4a
Bit rate: 8 kbps to 320 kbps (CBR)
Sampling frequency: 8 kHz to 48 kHz

FLAC compatibility

USB storage device

File extension: .flac
Bit rate: 8 kbps, 16 kbps, 24 kbps
Sampling frequency: 8 kHz to 48 kHz

DivX compatibility

- This product is not compatible with the following: DivX Ultra format, DivX files without video data, DivX files encoded with LPCM (Linear PCM) audio codec
- Depending on the file information composition, such as the number of audio streams, there may be a slight delay in the start of playback on discs.
- If a file contains more than 4 GB, playback stops before the end.
- Some special operations may be prohibited because of the composition of DivX files.
- Files with high transfer rates may not be played back correctly. The standard transfer rate is 4 Mbps for CDs and 10.08 Mbps for DVDs.
- DivX files on the USB storage device cannot be played.

CD-R/-R

File extension: .avi/.divx
Profile (DivX version): Home Theater Ver. 3.11/Ver. 4.x/Ver. 5.x/Ver. 6.x

Compatible audio codec: MP3, Dolby Digital
Bit rate (MP3): 8 kbps to 320 kbps (CBR), VBR
Sampling frequency (MP3): 16 kHz to 48 kHz (32 kHz, 44.1 kHz, 48 kHz for emphasis)
Maximum image size: 720 pixels × 576 pixels
Maximum file size: 4 GB

DVD-R/-R SL/-R DL/ DVD-R

File extension: .avi/.divx
Profile (DivX version): Home Theater Ver. 3.11/Ver. 4.x/Ver. 5.x/Ver. 6.x

Compatible audio codec: MP3, Dolby Digital
Bit rate (MP3): 8 kbps to 320 kbps (CBR), VBR
Sampling frequency (MP3): 16 kHz to 48 kHz (32 kHz, 44.1 kHz, 48 kHz for emphasis)
Maximum image size: 720 pixels × 576 pixels
Maximum file size: 4 GB

Video files compatibility (USB)

- Files may not be played back properly depending on the environment in which the file was created or on the contents of the file.
- This product is not compatible with packet write data transfer.
- This product can recognize up to 32 characters, beginning with the first character, including extension for the file and folder name. Depending on the display area, this product may try to display them with a reduced font size. However, the maximum number of the characters that you can display varies according to the width of each character, and of the display area.
- Folder selection sequence or other operations may be altered, depending on the encoding or writing software.
- Regardless of the length of blank section between the songs of original recording, compressed audio discs play with a short pause between songs.

.avi

Format: MPEG-4/H.264
Compatible video codec: MPEG-4 (Simple Profile)/H.264 (Base Line Profile)
Compatible audio codec: Linear PCM (LPCM) MP3
Maximum resolution: 640 pixels × 360 pixels
Maximum Frame rate: 30 fps
Maximum file size: 2 GB
Maximum playback time: 150 minutes

- Files may not be able to be played back depending on the bit rate.

.mp4

Format: MPEG-4/H.264
Compatible video codec: MPEG-4 (Simple Profile)/H.264 (Base Line Profile)
Compatible audio codec: AAC/Linear PCM (LPCM) MP3
Maximum resolution: 640 pixels × 360 pixels
Maximum Frame rate: 30 fps
Maximum file size: 2 GB
Maximum playback time: 150 minutes

- Files may not be able to be played back depending on the bit rate.

.3gp

Format: MPEG-4/H.264
Compatible video codec: MPEG-4 (Simple Profile)/H.264 (Base Line Profile)
Compatible audio codec: AAC/Linear PCM (LPCM) MP3
Maximum resolution: 640 pixels × 360 pixels
Maximum Frame rate: 30 fps
Maximum file size: 2 GB
Maximum playback time: 150 minutes

- Files may not be able to be played back depending on the bit rate.

.mkv

Format: MPEG-4/H.264
Compatible video codec: MPEG-4 (Simple Profile)/H.264 (Base Line Profile)
Compatible audio codec: AAC/Linear PCM (LPCM) MP3/AC-3
Maximum resolution: 640 pixels × 360 pixels
Maximum Frame rate: 30 fps
Maximum file size: 2 GB
Maximum playback time: 150 minutes

- Files may not be able to be played back depending on the bit rate.

.mov

Format: MPEG-4/H.264
Compatible video codec: MPEG-4 (Simple Profile)/H.264 (Base Line Profile)
Compatible audio codec: AAC/Linear PCM (LPCM) MP3
Maximum resolution: 640 pixels × 360 pixels
Maximum Frame rate: 30 fps
Maximum file size: 2 GB
Maximum playback time: 150 minutes

- Files may not be able to be played back depending on the bit rate.

Example of a hierarchy

- This product assigns folder numbers. The user cannot assign folder numbers.

Bluetooth



The *Bluetooth*® word mark and logos are registered trademarks owned by Bluetooth SIG, Inc. and any use of such marks by PIONEER CORPORATION is under license. Other trademarks and trade names are those of their respective owners.

Appendix

WMA

Windows Media is either a registered trademark or trademark of Microsoft Corporation in the United States and/or other countries.

This product includes technology owned by Microsoft Corporation and cannot be used or distributed without a license from Microsoft Licensing, Inc.

FLAC

Copyright © 2000-2009 Josh Coalson

Copyright © 2011-2013 Xiph.Org Foundation

Redistribution and use in source and binary forms, with or without modification, are permitted provided that the following conditions are met:

- Redistributions of source code must retain the above copyright notice, this list of conditions and the following disclaimer.
- Redistributions in binary form must reproduce the above copyright notice, this list of conditions and the following disclaimer in the documentation and/or other materials provided with the distribution.
- Neither the name of the Xiph.org Foundation nor the names of its contributors may be used to endorse or promote products derived from this software without specific prior written permission.

THIS SOFTWARE IS PROVIDED BY THE COPYRIGHT HOLDERS AND CONTRIBUTORS "AS IS" AND ANY EXPRESS OR IMPLIED WARRANTIES, INCLUDING, BUT NOT LIMITED TO, THE IMPLIED WARRANTIES OF MERCHANTABILITY AND FITNESS FOR A PARTICULAR PURPOSE ARE DISCLAIMED. IN NO EVENT SHALL THE FOUNDATION OR CONTRIBUTORS BE LIABLE FOR ANY DIRECT, INDIRECT, INCIDENTAL, SPECIAL, EXEMPLARY, OR CONSEQUENTIAL DAMAGES (INCLUDING, BUT NOT LIMITED TO, PROCUREMENT OF SUBSTITUTE GOODS OR SERVICES; LOSS OF USE, DATA, OR PROFITS; OR BUSINESS INTERRUPTION) HOWEVER CAUSED AND ON ANY THEORY OF LIABILITY, WHETHER IN CONTRACT, STRICT LIABILITY, OR TORT (INCLUDING NEGLIGENCE OR OTHERWISE) ARISING IN ANY WAY OUT OF THE USE OF THIS SOFTWARE, EVEN IF ADVISED OF THE POSSIBILITY OF SUCH DAMAGE.

DivX



DivX Certified® devices have been tested for high-quality DivX® (.divx, .avi) video playback. When you see the DivX logo, you know you have the freedom to play your favorite DivX movies. DivX®, DivX Certified® and associated logos are trademarks of DivX, LLC and are used under license.

This DivX Certified® device has passed rigorous testing to ensure it plays DivX® video.

To play purchased DivX movies, first register your device at vod.divx.com. Find your registration code in the DivX VOD section of your device setup menu.

- Refer to *Displaying your DivX VOD registration code* on page 46

AAC

AAC is short for Advanced Audio Coding and refers to an audio compression technology standard used with MPEG-2 and MPEG-4. Several applications can be used to encode AAC files, but file formats and extensions differ depending on the application which is used to encode. This unit plays back AAC files encoded by iTunes.

Android™

Android is a trademark of Google Inc.

Detailed information regarding connected iPod devices

- Pioneer accepts no responsibility for data lost from an iPod, even if that data is lost while using this product. Please back up your iPod data regularly.
- Do not leave the iPod in direct sunlight for extended amounts of time. Extended exposure to direct sunlight can result in iPod malfunction due to the resulting high temperature.
- Do not leave the iPod in any location with high temperatures.
- Firmly secure the iPod when driving. Do not let the iPod fall onto the floor, where it may become jammed under the brake or gas pedal.
- For details, refer to the iPod manuals.

iPhone and iPod



"Made for iPod" and "Made for iPhone" mean that an electronic accessory has been designed to connect specifically to iPod or iPhone, respectively, and has been certified by the developer to meet Apple performance standards.

Apple is not responsible for the operation of this device or its compliance with safety and regulatory standards.

Please note that the use of this accessory with iPod or iPhone may affect wireless performance.

iPhone, iPod, iPod classic, iPod nano, and iPod touch are trademarks of Apple Inc., registered in the U.S. and other countries.

Lightning

Lightning is a trademark of Apple Inc.

App Store

App Store is a service mark of Apple Inc.

iOS

iOS is a trademark on which Cisco holds the trademark right in the US and certain other countries.

iTunes

iTunes is a trademark of Apple Inc., registered in the U.S. and other countries.

Using app-based connected content

IMPORTANT

Requirements to access app-based connected content services using this product:

- Latest version of the Pioneer compatible connected content application(s) for the smartphone, available from the service provider, downloaded to your smartphone.
- A current account with the content service provider.
- Smartphone Data Plan.

Note: if the Data Plan for your smartphone does not provide for unlimited data usage, additional charges from your carrier may apply for accessing app-based connected content via 3G, EDGE and/or LTE (4G) networks.

- Connection to the Internet via 3G, EDGE, LTE (4G) or Wi-Fi network.
- Optional Pioneer adapter cable connecting your iPhone to this product.

Limitations:

- Access to app-based connected content will depend on the availability of cellular and/or Wi-Fi network coverage for the purpose of allowing your smartphone to connect to the Internet.
- Service availability may be geographically limited to the region. Consult the connected content service provider for additional information.
- Ability of this product to access connected content is subject to change without notice and could be affected by any of the following: compatibility issues with future firmware versions of smartphone; compatibility issues with future versions of the connected content application(s) for the smartphone; changes to or discontinuation of the connected Content application(s) or service by its provider.

Spotify®



Notice regarding video viewing

Remember that use of this system for commercial or public viewing purposes may constitute an infringement on the author's rights as protected by the Copyright Law.

Notice regarding DVD-Video viewing

This item incorporates copy protection technology that is protected by U.S. patents and other intellectual property rights of Rovi Corporation. Reverse engineering and disassembly are prohibited.

Using the LCD screen correctly

Handling the LCD screen

- When the LCD screen is subjected to direct sunlight for a long period of time, it will become very hot, resulting in possible damage to the LCD screen. When not using this product, avoid exposing it to direct sunlight as much as possible.
- The LCD screen should be used within the temperature ranges shown in *Specifications* on page 65.
- Do not use the LCD screen at temperatures higher or lower than the operating temperature range, because the LCD screen may not operate normally and could be damaged.
- The LCD screen is exposed in order to increase its visibility within the vehicle. Please do not press strongly on it as this may damage it.
- Do not push the LCD screen with excessive force as this may scratch it.
- Never touch the LCD screen with anything besides your finger when operating the touch panel functions. The LCD screen can scratch easily.

Liquid crystal display (LCD) screen

- If the LCD screen is near the vent of an air conditioner, make sure that air from the air conditioner is not blowing on it. Heat from the heater may break the LCD screen, and cool air from the cooler may cause moisture to form inside this product, resulting in possible damage.
- Small black dots or white dots (bright dots) may appear on the LCD screen. These are due to the characteristics of the LCD screen and do not indicate a malfunction.
- The LCD screen will be difficult to see if it is exposed to direct sunlight.
- When using a cellular phone, keep the antenna of the cellular phone away from the LCD screen to prevent disruption of the video in the form of disturbances such as spots or colored stripes.

Maintaining the LCD screen

- When removing dust from or cleaning the LCD screen, first turn this product off and then wipe the screen with a soft dry cloth.
- When wiping the LCD screen, take care not to scratch the surface. Do not use harsh or abrasive chemical cleaners.

Appendix

LED (light-emitting diode) backlight

A light emitting diode is used inside the display to illuminate the LCD screen.

- At low temperatures, using the LED backlight may increase image lag and degrade the image quality because of the characteristics of the LCD screen. Image quality will improve with an increase in temperature.
- The product lifetime of the LED backlight is more than 10,000 hours. However, it may decrease if used in high temperatures.
- If the LED backlight reaches the end of its product lifetime, the screen will become dimmer and the image will no longer be visible. In that case, please consult your dealer or the nearest authorized Pioneer Service Station.

Specifications

General

Rated power source.....	14.4 V DC (10.8 V to 15.1 V allowable)
Grounding system.....	Negative type
Maximum current consumption	10.0 A
Dimensions (W × H × D):	
DIN	
Chassis	180 mm × 50 mm × 160 mm (7-1/8 in. × 2 in. × 6-1/4 in.)
Nose	188 mm × 58 mm × 32 mm (7-3/8 in. × 2-1/4 in. × 1-1/4 in.)
D	
Chassis	178 mm × 50 mm × 165 mm (7 in. × 2 in. × 6-1/2 in.)
Nose	170 mm × 46 mm × 27 mm (6-3/4 in. × 1-3/4 in. × 1 in.)
Weight	2.0 kg (4.4 lbs)

Display

Screen size/aspect ratio	7.0 inch wide/16:9 (effective display area: 154.1 mm × 85.9 mm) (6-1/8 in. × 3-3/8 in.)
Pixels	1 152 000 (2 400 × 480)
Display method.....	TFT Active matrix driving
Color system.....	PAL/NTSC/PAL-M/PAL-N/SECAM compatible

Audio

Maximum power output	•50 W × 4 ch/4 Ω •50 W × 2 ch/4 Ω + 70 W × 1 ch/2 Ω (for subwoofer)
----------------------------	--

Continuous power output	22 W × 4 (50 Hz to 15 kHz, 5 %THD, 4 Ω LOAD, Both Channels Driven)
Load impedance	4 Ω (4 Ω to 8 Ω [2 Ω for 1 ch] allowable)
Preout output level (max).....	4.0 V
Equalizer (13-Band Graphic Equalizer):	
Frequency	50 Hz/80 Hz/125 Hz/200 Hz/315 Hz/500 Hz/800 Hz /1.25 kHz/2 kHz/3.15 kHz/5 kHz/8 kHz/12.5 kHz
Gain	± 12 dB (2 dB/step)
<Standard Mode>	
HPF:	
Frequency	50 Hz/63 Hz/80 Hz/100 Hz/125 Hz/160 Hz/200 Hz
Slope	-6 dB/oct, -12 dB/oct, -18 dB/oct, -24 dB/oct, OFF
Subwoofer/LPF:	
Frequency	50 Hz/63 Hz/80 Hz/100 Hz/125 Hz/160 Hz/200 Hz
Slope	-6 dB/oct, -12 dB/oct, -18 dB/oct, -24 dB/oct, OFF
Gain	+ 10 dB to -24 dB (1 dB/step)
Phase	Normal/Reverse
Time alignment	0 to 140 step (1 inch/step)
Bass boost:	
Gain	+ 12 dB to 0 dB
Speaker level	+ 10 dB to -24 dB (1 dB/step)
<Network Mode>	
HPF (High):	
Frequency	1.25 kHz/1.6 kHz/2 kHz/2.5 kHz/3.15 kHz/4 kHz /5 kHz/6.3 kHz/8 kHz/10 kHz/12.5 kHz
Slope	-6 dB/oct, -12 dB/oct, -18 dB/oct, -24 dB/oct
HPF (Mid):	
Frequency	25 Hz/31.5 Hz/40 Hz/50 Hz/63 Hz/80 Hz/100 Hz/125 Hz /160 Hz/200 Hz/250 Hz
Slope	-6 dB/oct, -12 dB/oct, -18 dB/oct, -24 dB/oct, OFF
LPF (Mid):	
Frequency	1.25 kHz/1.6 kHz/2 kHz/2.5 kHz/3.15 kHz/4 kHz /5 kHz/6.3 kHz/8 kHz/10 kHz/12.5 kHz
Slope	-6 dB/oct, -12 dB/oct, -18 dB/oct, -24 dB/oct, OFF
Subwoofer:	
Frequency	25 Hz/31.5 Hz/40 Hz/50 Hz/63 Hz/80 Hz/100 Hz/125 Hz /160 Hz/200 Hz/250 Hz
Slope	-12 dB/oct, -18 dB/oct, -24 dB/oct, -30 dB/oct, -36 dB/ oct, OFF
Gain	+ 10 dB to -24 dB (1 dB/step)
Phase	Normal/Reverse
Time alignment	0 to 140 step (1 inch/step)
Bass boost:	
Gain	+ 12 dB to 0 dB
Speaker level	+ 10 dB to -24 dB (1 dB/step)

DVD drive

System	DVD-Video, VCD, CD, MP3, WMA, AAC, DivX, MPEG player
Usable discs.....	DVD-VIDEO, VIDEO-CD, CD, CD-R, CD-RW, DVD-R, DVD-RW, DVD-RDL

Region number	1
Signal Format:	
Sampling frequency.....	32 kHz/44.1 kHz/48 kHz/96 kHz
Number of quantization bits.....	16 bit/20 bit/24 bit; linear
Frequency response	5 Hz to 22 000 Hz (with DVD, at sampling frequency 48 kHz)
Signal-to-noise ratio	91 dB (1 kHz) (IHF-A network) (RCA level)
Output level:	
Video	1.0 Vp-p/75Ω (±0.2 V)
Number of channels.....	2 (stereo)
MP3 decoding format.....	MPEG-1 & 2 Audio Layer 3
WMA decoding format	Ver.7, 7.1, 8, 9, 10, 11, 12 (2 ch audio) (Windows Media Player)
AAC decoding format	MPEG-4 AAC (iTunes encoded only): .m4a (Ver. 10.6 and earlier)
DivX decoding format	Home Theater Ver. 3, 4, 5, 2, 6 (Except ultra and HD) : avi, divx
MPEG video decoding format	MPEG-1, MPEG-2, MPEG-4 (part2), MS MPEG-4 (ver. 3)

USB

USB standard spec	USB 1.1, USB 2.0 full speed, USB 2.0 high speed
Max current supply	1.0 A
USB Class	MSC (Mass Storage Class), MTP (Media Transfer Protocol)
File system	FAT16, FAT32
MP3 decoding format	MPEG-1 & 2 Audio Layer 3
WMA decoding format	Ver. 7, 7.1, 8, 9, 10, 11, 12 (2 ch audio) (Windows Media Player)
AAC decoding format	MPEG-4 AAC (iTunes encoded only) (Ver. 10.6 and earlier)
FLAC decoding format	Ver. 1.3.0 (Free Lossless Audio Codec)
WAV signal format (MSC Mode only)	Linear PCM
Sampling Frequency.....	Linear PCM: 16 kHz, 22.05 kHz, 24 kHz, 32 kHz, 44.1 kHz, 48 kHz
JPEG decoding format (MSC Mode only)jpeg, .jpg, .jpe
Pixel Sampling	4:2:2, 4:2:0
Decode Size.....	MAX: 8 192 (H) × 7 680 (W), MIN: 32 (H) × 32 (W)
H.264 video decoding format	Base Line Profile
MPEG4 video decoding format	Simple Profile

Bluetooth

(AVH-X7800BT)	
Version	Bluetooth 3.0 certified
Output power.....	+4 dBm Max. (Power class 2)
Frequency band	2 400 MHz to 2 483.5 MHz

Appendix

FM tuner

Frequency range 87.9 MHz to 107.9 MHz
Usable sensitivity 12 dBf (0.8 μ V/75 Ω , mono, S/N: 30 dB)
Signal-to-noise ratio 72 dB (analog broadcasting) (IHF-A network)

AM tuner

Frequency range 530 kHz to 1 710 kHz
Usable sensitivity 28 μ V (S/N: 20 dB)
Signal-to-noise ratio 62 dB (analog broadcasting) (IHF-A network)

CEA2006 Specifications



Power output 14W RMS \times 4 Channels (4 Ω and \leq 1 % THD+N)
S/N ratio 91dBA (reference: 1 W into 4 Ω)
 Specifications and design are subject to possible modifications without notice due to improvements.