

PIERCE

PULLING FOR YOU

OWNER'S MANUAL
PSW654 INDUSTRIAL WINCHES

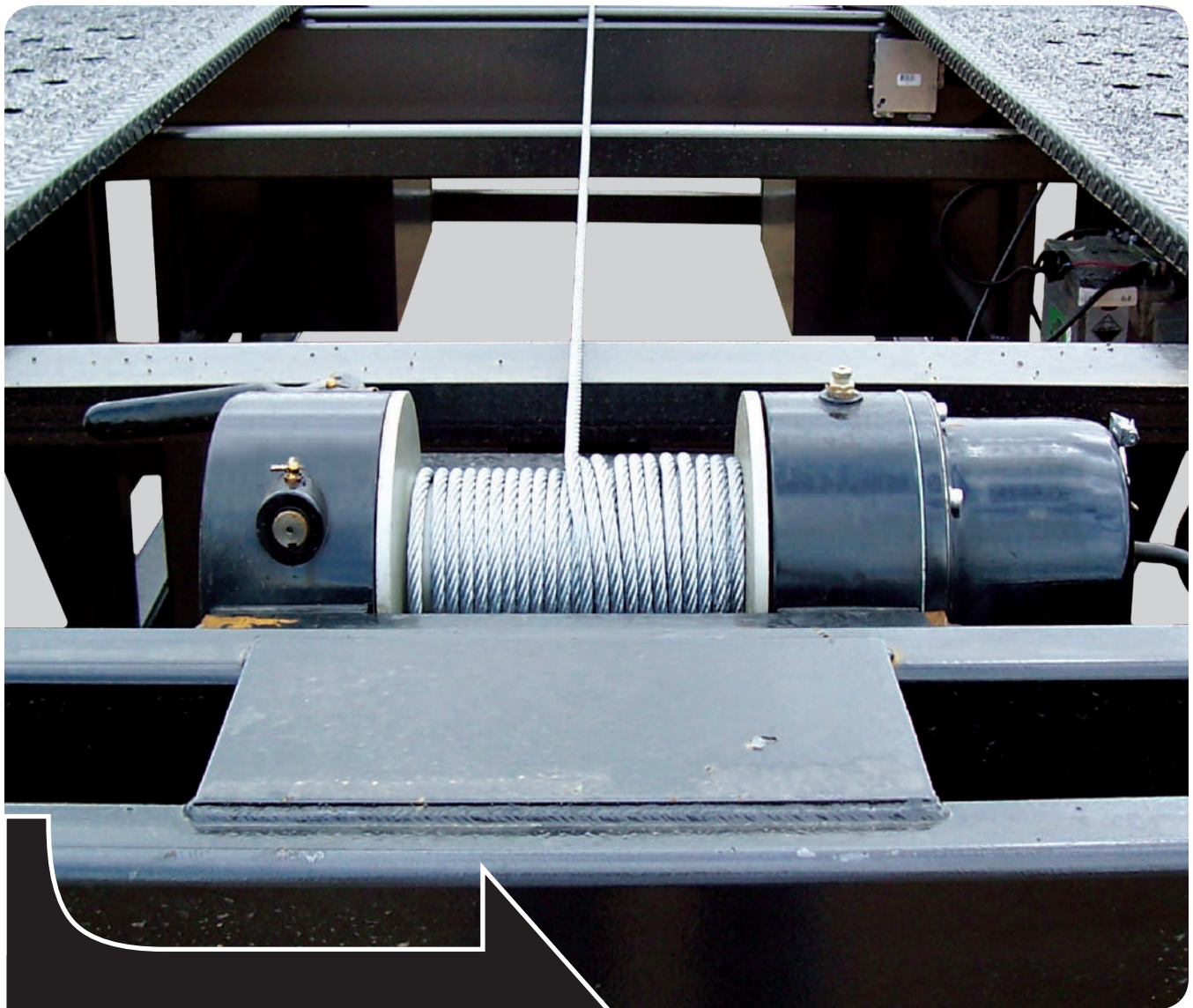

REGISTER YOUR PRODUCT!

Why register?

- receive product updates via email
- receive maintenance reminders via email
- receive quick technical service help if you encounter a problem

DISCLAIMER

The PSW654 series winch is a powerful tool and must be used with extreme care. Deviating from the manual's instructions may cause personal injury. You may void your warranty if you do not follow the precautions and guidelines outlined in this manual. Keep this manual in a safe place to reference safety and installation instructions, maintenance guidelines and operating recommendations. The owner, operator, and installer must read the entire manual before operating the winch.

SHIPMENT CONTENTS

PSW654-K / PSW654-MK

- 1 – Winch
- 1 – Remote Control
- 1 – Clutch Lever
- 1 – Key
- 8 – Winch Mounting Bolts
- 8 – 3/8" Lock Washers
- 1 – Set Screw
- 1 – Owner's Manual

PSW654-EK

- 1 – Winch
- 1 – Owner's Manual

PSW654-HK

- 1 – Winch
- 1 – Clutch Lever
- 1 – Key
- 1 – Hydraulic Motor
- 1 – Motor Coupler
- 8 – Winch Mounting Bolts
- 2 – 1/2" x 1 1/2" Motor Bolts
- 8 – 3/8" Lock Washers
- 2 – 1/2" Lock Washers
- 1 – 1/4" Set Screw
- 1 – Owner's Manual

SAFETY WARNINGS

DRESS PROPERLY

- DO NOT wear loose fitting clothing or jewelry.
- Tie back long hair.
- Wear leather gloves when handling the wire rope.
- Wear non-skid footwear during winch operation.
- Wear eye and ear protection during operation.

KEEP A SAFE DISTANCE

- DO NOT step over or under the wire rope.
- All onlookers must keep away from the work area.

- Never work on or around the winch drum when the winch is operating.
- DO NOT alter your winch in any way. Alterations may weaken the structural integrity of the winch and void your warranty.
- Operate your winch with an unobstructed view.

SPOOLING THE WIRE ROPE

- Wear leather gloves while spooling.
- **DO NOT allow the wire rope to thread through your hand without a glove.**
- Keep a slight load on the wire rope while spooling. Hold the wire rope with one gloved hand and the remote control in the other.

SAFETY WARNINGS (continued)

DO NOT MISUSE YOUR WINCH

- DO NOT lift items vertically. The winch was designed for horizontal use only.
- DO NOT operate the winch with less than eight wraps on the drum. The set screw on the drum is not designed to hold pull force of cable.
- Avoid continuous pulls from extreme angles. This will cause the wire rope to jam as it piles up on one side.
- Use a nylon sling when winching. Hooking the wire rope to itself will cause considerable damage to the wire rope.
- DO NOT move your vehicle to assist the winch in pulling the load. The combination of the winch and vehicle pulling could overload the wire rope and winch.
- Never release the free spool clutch when a load is connected to the winch.
- DO NOT exceed pulling limitations of winch.
- DO NOT shock loads when winching. A shock load occurs when increased force is suddenly applied to the wire rope.
- DO NOT use your winch as a hoist.
- DO NOT use your winch to lift, support, or transport people.
- DO NOT alter the warning instruction labels.
- DO NOT overheat your winch. Use your winch intermittently.
- Only use your winch for direct winching. Do not use your winch for jerking loads, towing or securing a load. Any damage incurred as a result of such action will void the warranty.
- DO NOT winch near electrical power lines.

DO NOT ABUSE THE WIRE ROPE

- Never carry your winch by the wire rope.
- Never yank the wire rope from the winch.
- Keep the wire rope from heat or sharp edges.
- **The cable must be spooled from the bottom of the drum.**

DO NOT OVERWORK YOUR WINCH

- DO NOT maintain power if the motor stalls.
- DO NOT exceed maximum line pull ratings.
- DO NOT overload your winch's pulling capacity. We recommend the use of a pulley block to double line the wire rope on heavy loads.
- DO NOT prolong pulls. The electric winch is designed for intermittent use only. If the motor becomes very hot, stop the winch and let it cool down for several minutes.

AVOID UNINTENTIONAL STARTING

- The winch clutch must be disengaged when not in use and fully engaged when in use.



disengaged

engaged

Note: The 110V/220V winches do not come equipped with a free-spool mechanism.

- The warranty will be voided if the winch is used when not properly engaged.
- Failure to use the winch without fully engaging the clutch may result in personal and property damage.
- Power must be disconnected when not in use.

MAINTAIN YOUR WINCH

- Before use, you must check your winch carefully.
- Damaged equipment must be properly repaired or replaced by the manufacturer or an authorized service center.
- Inspect and maintain the wire rope and winch frequently.
- Replace frayed rope strands immediately.
- Use only factory approved switches, remote controls and accessories.
- Check the tightness of the mounting bolts and electrical connections periodically.

SAFETY WARNINGS (continued)

OPERATION RECOMMENDATIONS

- DO NOT attach tow hooks to the winch mount.
- Use a snatch block to double your winch capacity, half the winch speed, and maintain a direct line pull to the center of the rollers.
- Use rated D ring or bow shackles in conjunction with an approved tree trunk protector to provide a safe anchor point.
- Position blocks under your vehicle's wheels when winching.
- Lay a heavy blanket or jacket over the wire rope when pulling heavy loads. Should wire rope failure occur the cloth may help prevent wire rope backlash.
- Use a crowbar or cable tensioner (PSCT8 or PSCT11) when guiding the wire rope over the drum. Never use your fingers.
- To reach the maximum rated line pull be sure the input voltage between the motor terminals is continuously 12 VDC.

Note: This winch only reaches the maximum rated line pull with the first layer of cable around the drum when pulling the loads.

- Plug in the remote control and engage the clutch before spooling. DO NOT engage the clutch while the motor is running.
- When using your winch to move a load, place the vehicle transmission in neutral, set vehicle brake, and lock all wheels. The vehicle engine should be running during winch operation. If winching is performed with the engine off, the battery may be too weak to restart the engine.
- Use chains or straps to secure the load, not your winch cable.
- Stay alert while winching. Stop every meter or five feet to ensure the wire rope is neatly wound around the drum.
- After winch operation, spool the extended cable tightly around the drum.
- Always release the load after operation.
- Store the remote control inside your vehicle.
- Inspect the control before use.
- Unless specified, PIERCE AC winches are not equipped with free spool.

PSW654-K / PSW654-MK

Electrical recommendations:

- Performance of an electric winch depends entirely upon its power supply. The winch will draw between 70 to 400 amps depending on the load. Under heavy pulling, even the largest batteries will become weak. Always leave the vehicle running when winching. You may also install a high ampere alternator to improve winch performance. DO NOT continue to winch when the battery power is low. Low voltage and amperage will cause the solenoids and the motor to overheat. Running the winch with a weak battery will often cause the points of the solenoids to become welded together.
- Performance is also directly related to conductor size. A larger conductor size is always preferable but is required if more than ten feet is used. The single wire extending from the winch should be attached to the positive post of a 12V battery. The minimum size conductor to use is a #4 welding lead. A #2 welding leading is highly recommended.
- A good ground wire is very important for successful winching. Both the winch and the solenoid assembly must be grounded. A bad ground may cause the winch not to run at all. Always install a ground cable of at least #4 gauge from the negative battery post to one of the motor mounting bolts on the winch. DO NOT connect the ground wire to any of the electrical terminals on the motor. DO NOT ground to the frame.
- A battery disconnect switch (PS025) is highly recommended when installing the winch. The operator or user must use some type of disconnect switch with a capacity of 400 amps when installing and operating the winch. The winch is to be left disconnected when not in use or unattended. Failure to use a battery disconnect switch will void your warranty.
- Make sure all cables are tight on both the ring connector and on the stud where they are attached. Care must be taken when installing a cable on the motor terminals. Nuts closest to the motor housing should be held with a wrench to prevent the stud from turning inside the motor. See page 14 for a wiring diagram.

SAFETY WARNINGS (continued)

PSW654-EK

Electrical recommendations:

- The breaker must be at least 35 amps on the circuit.
- The winch features a 100% duty cycle TEFC motor.
- To connect the winch to a power source, either plug into a wall outlet that has a 35 amp breaker on the circuit, or the plug can be removed and hard wired.

INSTALLATION

PSW654-EK

Mounting:

1. Your PSW654-EK winch is shipped fully assembled, mounted to a PBM1, wired and pre-lubricated (*figure 1*). A pre-wired remote is included (*figure 2*).
2. See *figure 3* for the mounting pattern of the PBM1. Mount to a flat surface using grade 5 or better bolts that are 3/8" thick and lock washers.
3. Your mounting plate must be 6mm or 1/4" thick. If a heavier mounting plate is used the bolts must be lengthened accordingly.

Electrical connections:

1. Connect the plug to an outlet with a dedicated 35 amp breaker.

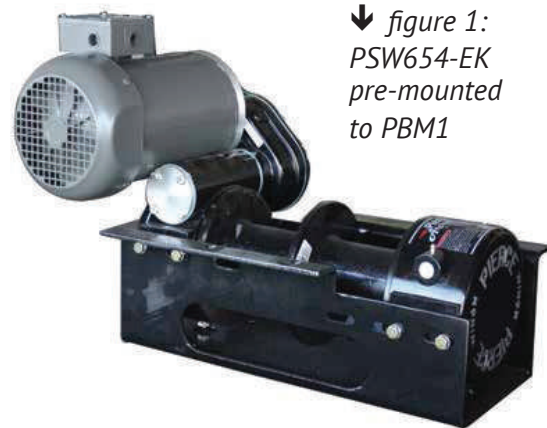

↓ *figure 1:*
PSW654-EK
pre-mounted
to PBM1



← *figure 2:*
Pre-wired remote

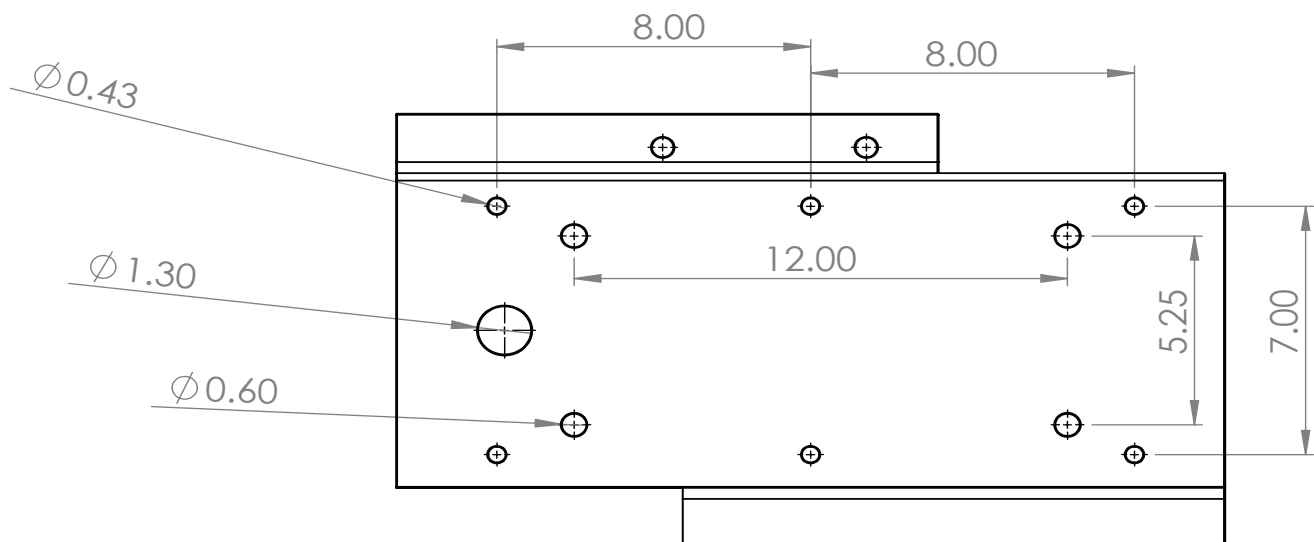

↑ *figure 3: Mounting pattern of the PBM1*

INSTALLATION *(continued)*

PSW654-HK

Mounting:

1. Before installation, ensure the mounting frame in use is capable of withstanding the winch's rated capacity.
2. Ensure the motor, drum and gear housing are properly aligned.
3. The clutch housing must be $1/16$ "- $1/8$ " from the drum.
4. Mount to a flat surface using grade 8 or better bolts that are $3/8$ " thick and lock washers.
5. Your mounting plate must be 6mm or $1/4$ " thick. If a heavier mounting plate is used the bolts must be lengthened accordingly.
6. The mounting frame must be secured using a minimum of 4, grade 8, $1/2$ " bolts and nuts.
7. All eight bolts (grade 8) should penetrate the mounting pads on the main gear housing and clutch housing by $3/4$ ".

Installing the hydraulic motor coupler:

1. Place the larger end of the coupler on the motor shaft.

2. Tighten the set screw in the coupler on the motor shaft.
3. Fit the motor and coupler to the winch ensuring that the key stays on the worm shaft.
4. Lastly, tighten the two bolts holding the hydraulic motor to the hydraulic housing coupler.
5. If the hydraulic motor is not running freely when operating, loosen the two large bolts one complete turn, briefly run the winch, then re-tighten the two bolts.

Hose connections:

1. Connect your hoses to the two $1/2$ " NPT ports on the motor.

Lubrication:

1. This winch is pre-greased and will not require oil. If the gears are changed at any time, use 20% Lucas HD oil stabilizer and 80% 15w-40 oil.
2. Lubricate both grease zerts on the clutch lever every six months with automotive grease (Mystic JT-6).



INSTALLATION *(continued)*

PSW654-K / PSW654-MK

Recommended options and accessories:

We used the following parts in our shop to complete the PIERCE winch installation (*see next page*). We do require the PS025 Safety Cut-off Switch, since the warranty will be voided without one. The other equipment listed is optional.

- **PSW654-11K - PIERCE Electric Worm Gear Winch:** Pierce 9,000 lb. has an 11" drum. It has a worm gear final drive, 60:1, and incorporates an additional reduction in the transfer case. It has an overall ratio of 470:1, giving these winches a no load line speed of 14' per minute (full cable on spool). Spool capacity is 125' of 3/8" cable, 200' of 5/16" cable.
- **PS025 - Safety Cut-Off Switch:** Use this lever-operated safety cut-off switch for any electric winch or pump installation, including our PSW654-11K. Protect your equipment from damage due to solenoid sticking or shorting. The safety cut-off switch is highly recommended to use with your winch, as the warranty will be voided without one.
- **PS501 Wiring:** During the winch installation, we used the PS501 600V supply cable by Essex. Contains 30 gallon strands of class K copper for extra flexibility (#4 = 413 Strands, #2 = 651 Strands). ExCELENE jacket resists oil, burning, abrasion, and cold weather.
- **PS501R or PS501X2R Wiring:** We also used the PS501R as the ground cable on step 5A. Standard #4 gauge red jacket welding cable. It acts as a power supply for winches, pumps, etc. Use #2 gauge for installs greater than 10' from the battery.
- **PT037 - Angle Mounts:** The winch frame we use is the PT037. Pre-drilled and notched 1/4" x 2" x 2" angle iron mounting brackets for all PS654 series winches with 8" or 11" drums. Use these mounts to recess your winch in a semi-hidden application or build your own custom mount.
- **PS002 - Wireless Remote:** Choose a PIERCE wireless remote system with a 200' range. The system comes with a transmitter and receiver.

- **P070 - Bridle Chain:** Our car carrier bridle is made of grade 43 chain and a 5/8" master link with two grab hooks for leg adjustment. Includes two 15" J hooks. Each leg is 24".

Recommended tools:

- Measuring tape
- Work gloves
- Crowbar
- 9/16" hex wrench
- 5/16" hex wrench
- 3/16" hex wrench
- Safety goggles
- First aid kit



PSW654-11K



PS025



PT037



P070



PS002

INSTALLATION (continued)

PSW654-K / PSW654-MK (continued)

1. After removing the winch from the box, install the angle mounts onto the winch frame.

Tip: When placing the frame onto mount, make sure the hole as shown in the image is directly above the oil fill.



2. Measure the finished winch frame to ensure a clean placement on the truck bed.

Tip: Making sure to have the correct dimensions of the frame is critical for an easy install.



3. As dimensions match, place the winch carefully onto the truck bed. As shown, framing the angle mounts are an option for a clean, more finished look.

Note: We used some extra angle iron to make a clean housing for our mount.

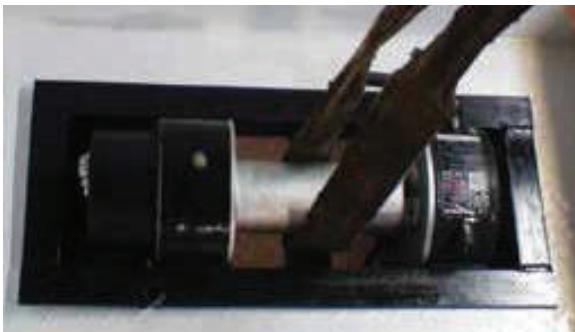

4. After successfully placing the winch on your truck, mount the frame. Using a total of eight grade 8, or "G8" bolts at least 3/8" thick is required. Lock washers as well.

Tip: All eight bolts should penetrate the mounting pads on the main gear housing and clutch housing at exactly 3/4" deep.



5. Next, connect the power cable from the solenoid to a positive power source. Wire a 4 gauge ground from the winch motor mounting bolt directly to the negative terminal of the truck battery using the PS501 or PS501X2.

Note: The ground wire must be the same size (or larger) as the power wire.



6. Install and connect the safety cut-off switch at any easy, reachable distance from the winch. We hooked the PS501R cable to the cut-off switch.

Tip: If the 4 gauge wire can't reach the truck's battery, be sure to use our 2 gauge to reach the battery for lengths over 10'.



INSTALLATION (continued)

7. After connecting the cut-off switch and the ground line to the truck battery, install the wire rope onto the drum as shown. Feed the remaining length onto the winch drum while keeping the tension high.

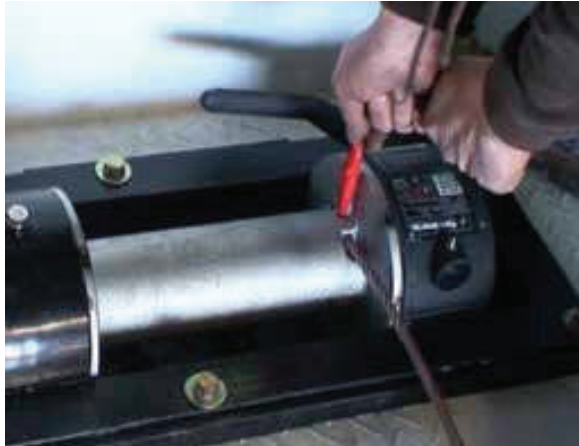

8. Next, power the newly mounted and installed winch. Pull the cable in while applying resistance and tension. Otherwise, the cable will let loose on you and will tangle on the drum.

Tip: Have a partner grab the hook on the end of the cable and pull enough to emulate that resistance needed.



MOUNTING PATTERNS

These mounting patterns are intended to be used with PIERCE pre-drilled and notched $\frac{1}{4}$ " x 2" x 2" angle iron mounting brackets (PT037). Use these mounts to recess your winch in a semi-hidden application or build your own custom mount. All measurements are center-to-center.

PRO TIP: Each hole should be drilled out $\frac{3}{8}$ " x 1" slotted to allow for adjustments during installation.

PSW654-8K
PSW654-8MK
PSW654-8HK

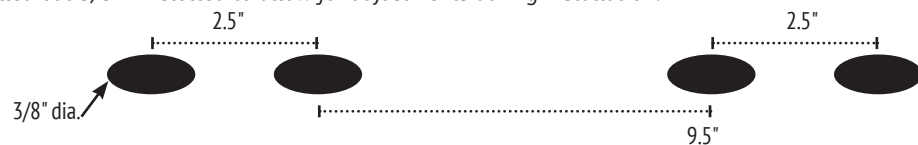

PSW654-11K
PSW654-11MK
PSW654-11HK



PSW654-8EK

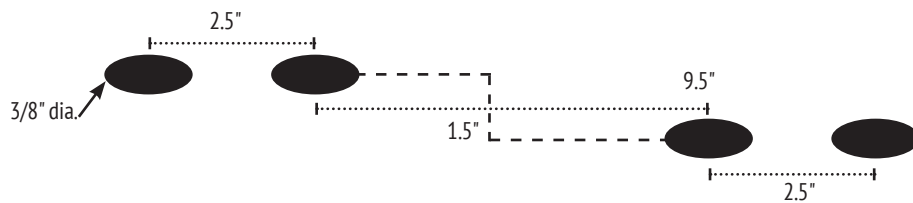

PSW654-11EK

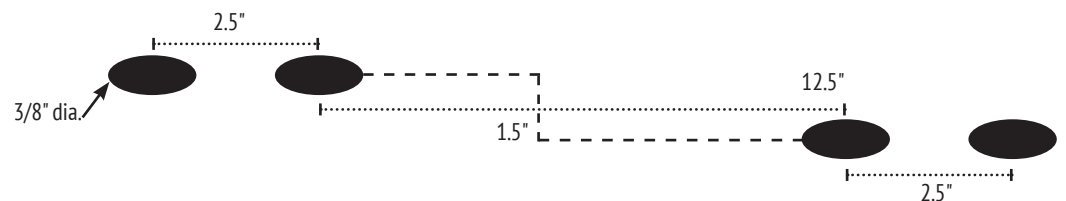

OPERATION

The first use of your winch must be a test run during a non-recovery situation. During this trial run, begin to recognize the sound of a steady pull, a heavy pull, load jerking or shifting.

Spooling the wire rope:

- Wear leather gloves while spooling.
- **DO NOT allow the wire rope to thread through your hand without a glove.**
- Unwind the wire rope carefully along the floor to avoid kinking.
- Place the end of the wire rope into the hole on the side of the drum. The wire rope will protrude ½" - 1". Tighten the set screw.
- Keep a slight load on the wire rope while spooling.
- Using the remote control, wrap the wire rope onto the drum until the load is recovered. Make sure the wire rope lays smoothly onto the drum without spacing or overlapping using a crowbar or cable tensioner.

Test run:

- Spool the wire rope until the red mark appears at five wraps.
- Under a load of 500 lbs (230 kg) re-spool the wire rope. This will stretch the new wire rope and create a tight wrap around the drum.

PSW654-K / PSW654-MK

1. Place the transmission in neutral and apply the parking brake or lock the wheels.
2. Spool the winch cable and connect to an anchor point.
3. Engage the clutch by shifting it into the IN position. Use force to engage the clutch. If the freewheel easily moves IN and OUT of position then the winch is not fully engaged.
Note: When the clutch is engaged your load will be securely held until the remote is used.
4. Check cable rigging before proceeding.
5. Plug in the winch remote control located on the solenoid assembly.

Note: To ensure safe operation, it is recommended that winch operation take place from the driver's position.

6. Start vehicle engine, select neutral or park and maintain idle engine speed.
7. Using the remote control, press IN or OUT until the vehicle has been retrieved. Regularly check to ensure the cable is winding onto the drum evenly.
8. Secure your load using straps or chains.
9. Re-spool the wire rope after the winch operation is completed.

PSW654-HK

1. Apply the parking brake or lock the wheels.
2. Spool the winch cable and connect to an anchor point.
3. Engage the clutch by shifting it into the IN position. Use force to engage the clutch. If the freewheel easily moves IN and OUT of position then the winch is not fully engaged.
Note: When the clutch is engaged your load will be securely held until the remote is used.
4. Check cable rigging before proceeding.
5. Secure the load using chains or straps, not your winch wire rope.
6. To ensure safe operation, it is recommended that winch operation take place from the driver's position. Re-spool the wire rope after the winch operation is completed.

PSW654-EK

1. Turn on the breaker.
2. Spool the cable and connect to an anchor point.
3. Check the cable rigging before proceeding.
4. Re-spool the wire rope after the winch operation is completed.

MAINTENANCE

PSW654-K / PSW654-MK

- Winches are pre-greased and do not require additional lubrication. If the gears are changed at any time, use 20% Lucas HD oil stabilizer and 80% 15w-40 oil. Each housing will use 8-12 oz.
- Check the grease fittings on clutch housing. Grease every 3-6 months or as needed.
- Check all the electrical connections to ensure good contact and no corrosion. Replace as needed.
- Check all accessible bolts to ensure they are tightly bound.
- Check the wire rope for kinks or frays. Replace with a wire rope of equal strength.
- Check the clutch dog, clutch yoke and drum for damage.
- Contact your service center or the manufacturer before servicing your winch.

PSW654-HK

- Winches are pre-greased and do not require additional lubrication. If the gears are changed at any time, use 20% Lucas HD oil stabilizer and 80% 15w-40 oil. The housing will use 8-12 oz.
- Check the grease fittings on clutch housing. Grease every 3-6 months or as needed.

- Check all the hose connections to ensure good contact and no corrosion. Replace as needed.
- Check all accessible bolts to ensure they are tightly bound.
- Check the wire rope for kinks or frays. Replace with a wire rope of equal strength.
- Check the clutch dog, clutch yoke and drum for damage.
- Contact your service center or the manufacturer before servicing your winch.

PSW654-EK

- Winches are pre-greased and do not require additional lubrication. If the gears are changed at any time, use 20% Lucas HD oil stabilizer and 80% 15w-40 oil. Each housing will use 8-12 oz.
- Check all electrical connections.
- Check all fan blades to keep motor cool. Replace if damaged before operation.
- Check all accessible bolts to ensure they are tightly bound.
- Check the wire rope for kinks or frays. Replace with a wire rope of equal strength.
- Check capacitor seal every 3 - 6 months.
- Contact your service center or the manufacturer before servicing your winch.

FAQ

Can I increase the line speed of my worm drive winch?

Yes, but you will lose about half of your pulling power. On electric winches, a simple exchange of gears can provide up to a 50% line speed increase, and on hydraulic winches, you can change your motor to one with a different displacement.

How much wire rope will my winch hold?

The 8" drum will hold 100' of 3/8" cable, and the 11" drum will hold 125'.

Can I use a fuse to protect my winch and vehicle?

Use of a fuse, or some circuit interrupting device, is highly recommended. A better idea would be to use a breaker. High amp fuses are costly, and amperage spikes are not uncommon when winching. A breaker that will throw at 400 amps is ideal. It may cost more in the beginning, but will far outweigh the cost of replacing 400 amp fuses. Cut-off switches are less costly. While they do not prevent amperage spikes, they will allow you to disconnect power in the event of a short in the winch.

<p>Does my winch need it's own battery?</p>	<p>Most electrical systems aren't designed for accessories like a winch. Your winch will work with your OEM battery, but there is a heavy amperage load while winching. Think of the amperage to start your truck. It would be like starting your truck the whole time you are winching. It is a good idea to use a deep cycle battery, or even add a battery to your system just for your winch if you can. Just make sure your charging system can handle the load as well.</p>
<p>How much and what type of oil does my winch need?</p>	<p>PIERCE winches come pre-lubricated.</p>
<p>How can I test my motor?</p>	<p>See diagram below. Disconnect all three wires from your motor, making sure to mark which wire is which for re-connection. Supply a solid ground connection to the motor casing. Next, connect 12V to field terminal, F1. Take a long screwdriver, or similar tool, and make contact between field terminal, F2, and the armature post. This should bridge the electrical connection and start your motor. Now do this with the opposite field terminal. Connect power to F2, then make contact from F1 to the armature post. Again, your motor should run. If the motor is unresponsive to both tests the motor must be replaced with a PS534H Pierce 12V motor.</p>

MOTOR TEST PROCEDURE

If your motor is unresponsive, please follow these steps to test the power. If the test proves unsuccessful, your motor will need to be replaced with a PS534H.

1. Remove any wires connected to A, F1 and F2.
2. Apply power to F2. Connect terminal A to F1 with a screwdriver.
3. Apply power to F1. Connect terminal A to F2 with a screwdriver.

Note: The motor must be grounded to the motor casing, not the electrical terminals.

- GROUND
- + 12V
- F1 FIELD 1
- F2 FIELD 2
- A ARMATURE

Step 2

- Mount ground to motor casing.

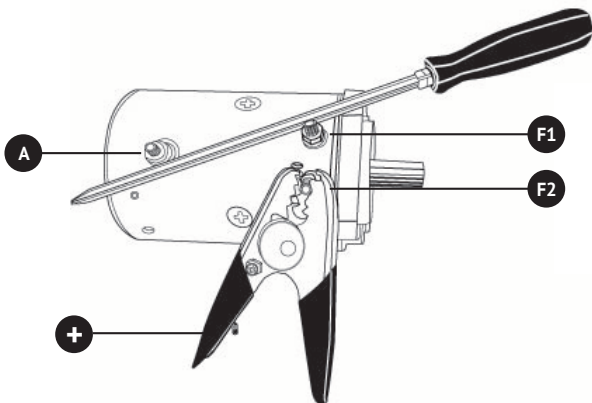

Step 3

- Mount ground to motor casing.

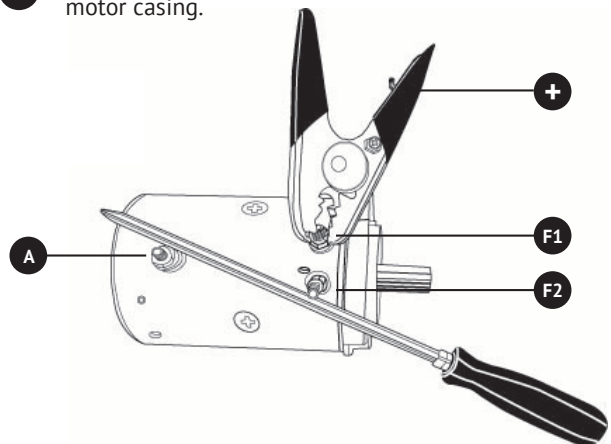

SPECIFICATIONS

	PSW654-8K	PSW654-11K	PSW654-8MK	PSW654-11MK	PSW654-8EK	PSW654-11EK	PSW654-8EMK	PSW654-11EMK	PSW654-8HK	PSW654-11HK
POWER SOURCE	electric	electric	electric	electric	electric	electric	electric	electric	hydraulic	hydraulic
DESCRIPTION	9,000 lb DC 8" drum	9,000 lb DC 11" drum	12,500 lb DC 8" drum	12,500 lb DC 11" drum	7,500 lb AC 8" drum	7,500 lb AC 11" drum	11,000 lb AC 8" drum	11,000 lb AC 11" drum	9,000 lb hydraulic 8" drum	9,000 lb hydraulic 11" drum
CAPACITY	4.5 T	4.5 T	6.25 T	6.25 T	3.75 T	3.75 T	5.5 T	5.5 T	4.5 T	4.5 T
VOLTAGE / MAX OIL FLOW	12V	12V	12V	12V	110/220 V	110/220 V	110/220 V	110/220 V	15 gpm	15 gpm
AMPERE / PRESSURE	400 amps with load	400 amps with load	400 amps with load	400 amps with load	17.4 amps at 115V	17.4 amps at 115V	17.4 amps at 115V	17.4 amps at 115V	2,000 psi	2,000 psi
CABLE	3/8" x 100'	3/8" x 125'	3/8" x 100'	3/8" x 125'	3/8" x 100'	3/8" x 100'	3/8" x 125'	3/8" x 125'	3/8" x 100'	3/8" x 125'
UNIT	16.5" x 13.5"	19.25" x 13.5"	16.25" x 8" x 13.5"	19.25" x 8" x 13.5"	26" x 15" x 17.5"	26" x 15" x 17.5"	26" x 15" x 17.5"	26" x 15" x 17.5"	16.25" x 8" x 13.5"	19.25" x 8" x 13.5"
DRUM	3.5" x 8"	3.5" x 11"	3.5" x 8"	3.5" x 11"	3.5" x 8"	3.5" x 11"	3.5" x 8"	3.5" x 11"	3.5" x 8"	3.5" x 11"
SPEED	14 fpm	14 fpm	9 fpm	9 fpm	4 fpm	4 fpm	4 fpm	4 fpm	12.6 fpm	12.6 fpm
WEIGHT	88 lbs	92 lbs	88 lbs	92 lbs	123 lbs	125 lbs	123 lbs	125 lbs	70 lbs	72 lbs
MOTOR	1.5 hp	1.5 hp	1.5 hp	1.5 hp	1.5 hp	1.5 hp	1.5 hp	1.5 hp	4.8 cu. in/rev	4.8 cu. in/rev
RATIO	470:1	470:1	728.5:1	728.5:1	460:1	460:1	460:1	460:1	60:1	60:1
ROTATION	CW/CCW	CW/CCW	CW/CCW	CW/CCW	CW/CCW	CW/CCW	CW/CCW	CW/CCW	CW/CCW	CW/CCW
GEAR TRAIN	worm gear	worm gear	worm gear	worm gear	worm gear	worm gear	worm gear	worm gear	worm gear	worm gear
CLUTCH	dog	dog	dog	dog	dog	dog	dog	dog	dog	dog
BRAKE	worm gear	worm gear	worm gear	worm gear	worm gear	worm gear	worm gear	worm gear	worm gear	worm gear

WIRING DIAGRAM

In the event that the compact solenoid assembly, motor, or plug requires replacement, please use the diagram below to connect the wires.

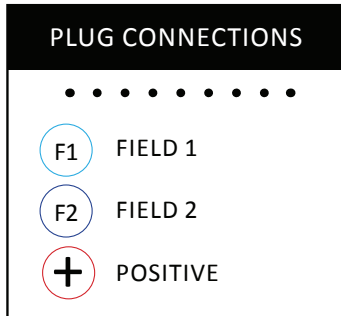

MOTOR CONNECTIONS
PS528C-N

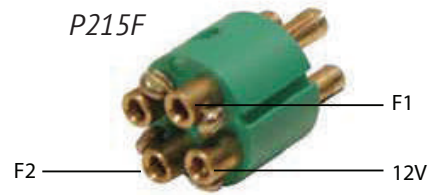
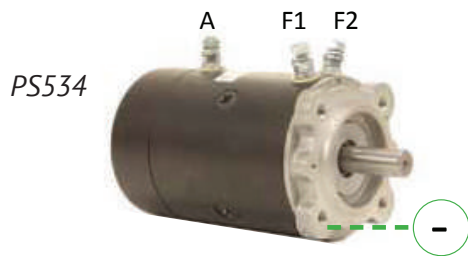
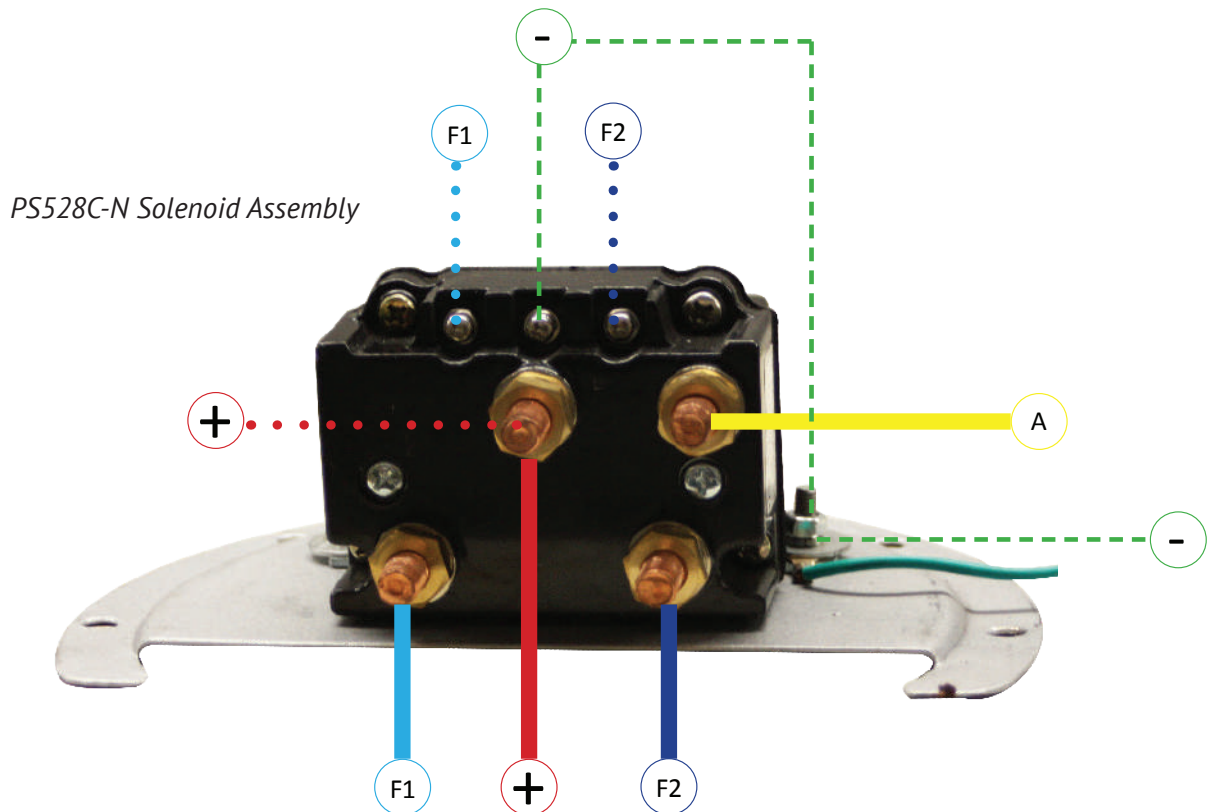
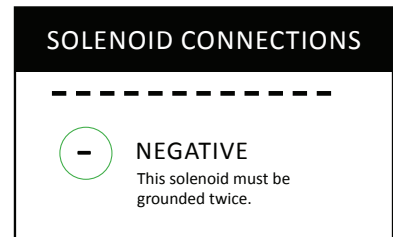
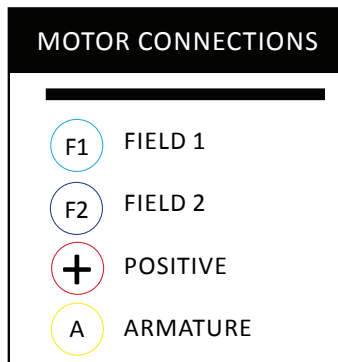

NOTE: The ground from the solenoid and the ground from the negative of the battery should be on the same bolt.

PARTS DIAGRAMS

PSW654-K

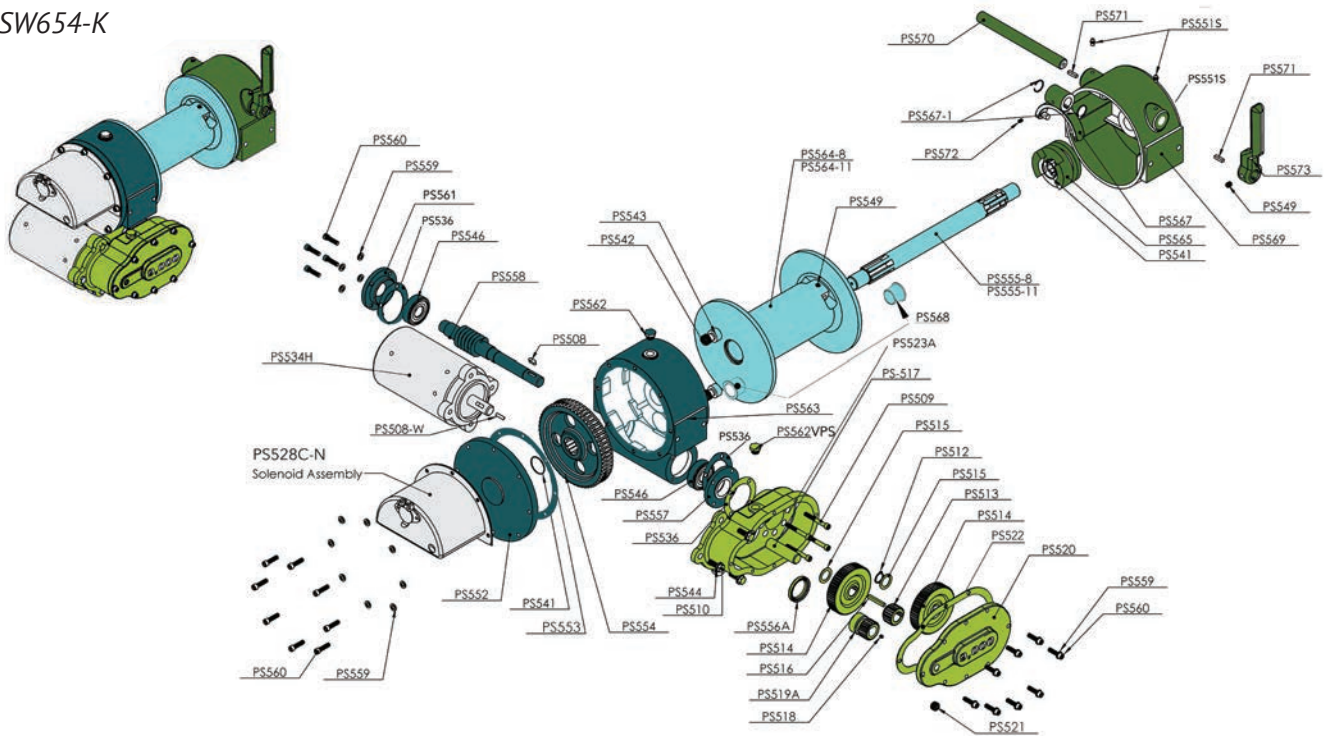

PART NUMBER	DESCRIPTION	PART NUMBER	DESCRIPTION	PART NUMBER	DESCRIPTION
PS559	1/4" A/N Washer	PS514	Transfer Gear	PS552	Main Gear Cover
PS560	1/4" Allen Head Cap Screw	PS520	Transfer Gear Housing Cover	PS541	External Retainer Snap Ring
P040	PIERCE Wired Remote	PS522	Transfer Gear Gasket	PS508	Square Key
PSCSP	Solenoid	PS521	Winch Plug	PS562	Main Housing Cover Plug
PS528C-N	Total Solenoid Assembly, Cover and Electrical wiring	PS559	1/4" A/N Washer	PS542	Drag Brake Spring
PS534H	12V Motor	PS560	1/4" Allen Head Cap Screw	PS557	Open Bearing Cap
PS534HGK	12V Motor (PS534H) with Motor Drive Gear (PS519A)	PS518	Motor Gear Set Screw	PS543	Nylon Drag Brake
PS508	Square Key	PS519A	Motor Drive Gear	PS5648	8" Drum
PS508-W	Woodruff Key	PS516	Long PW Key	PS56411	11" Drum
P040	PIERCE Wired Remote	PS556A	Motor Seal	PS555-8	8" Shaft
PSCSP	Solenoid	PS544	3/8" Lock Washer	PS555-11	11" Shaft
PS025	Safety Cut Off Switch	PS510	Motor Mount Screw	PS549	Drum Set Screw
FUS-LINK	400 Amp Fuse	PS562VPS	1/4" Breather Vent	PS568	Drum Bushing
ASTC9032	Quick Connects - 2 gauge	PS536	Worm Gasket	PS541	External Retainer Snap Ring
PS523A	Transfer Housing	PS546	Bearing	PS565	Clutch Dog
PS517	Power Shaft	PS563	Main Gear Housing	PS567	Shift Yoke
PS509	1/4" x 1 3/4" Mounting Screw	PS558	Worm Gear	PS569	Clutch Housing
PS515	Spacer	PS536	Worm Gasket	PS549	Drum Set Srew
PS512	Small External Snap Ring Retainer	PS561	Closed Cap Bearing	PS571	Handle Key
PS515	Spacer	PS559	1/4" A/N Washer	PS573	Clutch Lever
PS513	Idler Gear	PS560	1/4" Allen Head Cap Screw	PS551S	Grease Fitting
		PS554	Main Gear	PS570	Clutch Shaft
		PS553	Main Gear Gasket	PS567-1	Shift Yoke Shaft Spring
				PS572	Clutch Handle Set

PARTS DIAGRAMS

PSW654-EK

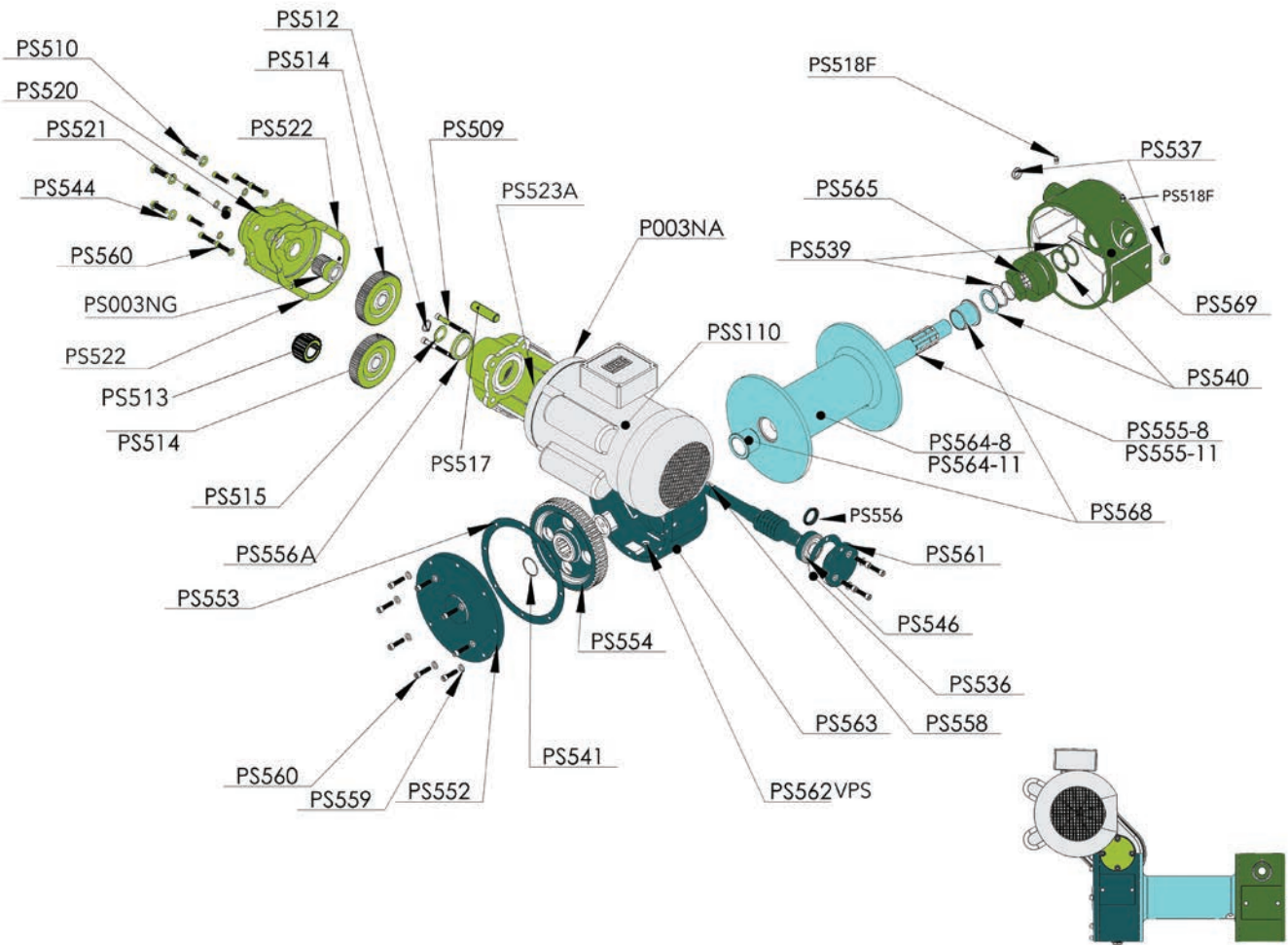

PART NUMBER	DESCRIPTION	PART NUMBER	DESCRIPTION	PART NUMBER	DESCRIPTION
PSS110	110V Motor	PS522	Transfer Housing Gasket	PS546	Bearing
P003NS	Intermittent Remote	PS513	Idler Gear	PS556	Motor Seal
P003NSC	Continuous Remote	PS514	Transfer Gear	PS561	Closed Cap Bearing
PS523A	Transfer Housing	PS515	Spacer	PS564-8	8" Drum
P003NA	Aluminum Adapter	PS556A	Motor Seal	PS564-11	11" Drum
PS509	1/4" x 1 3/4" Mounting Screw	PS517	Power Shaft	PS555-8	8" Shaft
PS512	Small External Snap Ring Retainer	PS553	Main Gear Gasket	PS555-11	11" Shaft
		PS560	1/4" Allen Head Cap Screw	PS549	Drum Set Screw
PS514	Transfer Gear	PS559	1/4" A/N Washer	PS539	External Retainer Snap Ring
PS522	Transfer Gear Gasket	PS552	Main Gear Cover	PS568	Drum Bushing
PS510	Motor Mount Screw	PS541	External Retainer Snap Ring	PS540	.055 Thrust Washer
PS520	Transfer Gear Housing Cover	PS554	Main Gear	PS540	.055 Thrust Washer
PS521	Winch Plug	PS562VPS	1/4" Breather Vent	PS565	Clutch Dog
PS544	3/8" Lock Washer	PS563	Main Gear Housing	PS569	Clutch Housing
PS560	1/4" Allen Head Cap Screw	PS558	Worm Gear	PS518F	Plug
P003NG	Motor Gear	PS536	Worm Gasket	PS537	Clutch Housing Plug

PARTS DIAGRAMS

PSW654-EMK

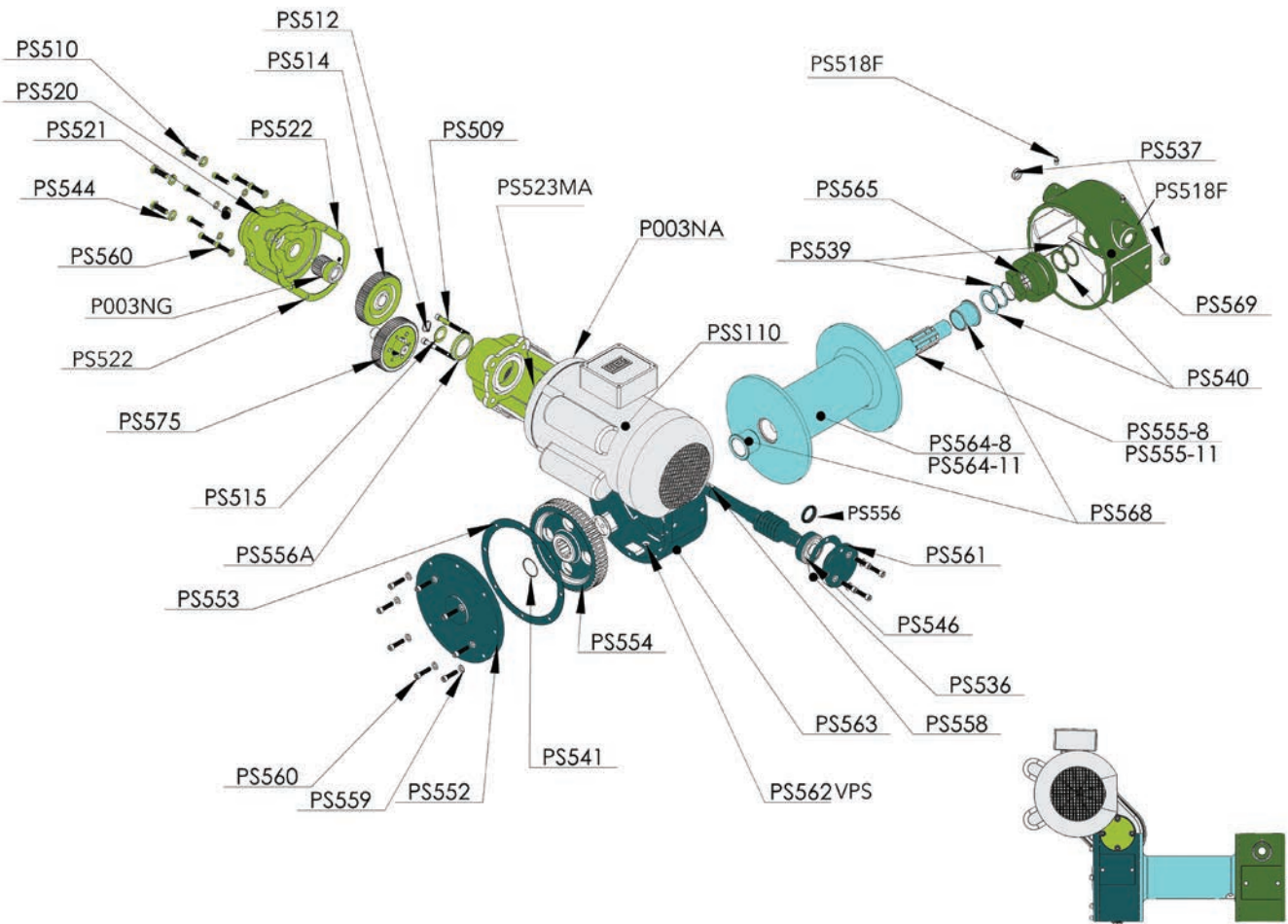

PART NUMBER	DESCRIPTION	PART NUMBER	DESCRIPTION	PART NUMBER	DESCRIPTION
PSS110	110V Motor	PS513	Idler Gear	PS536	Worm Gasket
P003NS	Intermittent Remote	PS508-W	Motor Woodruff Key	PS546	Bearing
P003NSC	Continuous Remote	PS575	Planetary Gear	PS561	Closed Cap Bearing
PS523MA	Transfer Housing	PS514	Transfer Gear	PS556	Motor Seal
P003NA	Aluminum Adapter	PS515	Spacer	PS564-8	8" Drum
PS509	1/4" x 1 3/4" Mounting Screw	PS556	Motor Seal	PS564-11	11" Drum
PS512	Small External Snap Ring Retainer	PS517	Power Shaft	PS555-8	8" Shaft
PS514	Transfer Gear	PS553	Main Gear Gasket	PS555-11	11" Shaft
PS522	Transfer Gear Gasket	PS560	1/4" Allen Head Cap Screw	PS549	Drum Set Screw
PS510	Motor Mount Screw	PS559	1/4" A/N Washer	PS539	External Retainer Snap Ring
PS520	Transfer Gear Housing Cover	PS552	Main Gear Cover	PS568	Drum Bushing
PS521	Winch Plug	PS541	External Retainer Snap Ring	PS540	.055 Thrust Washer
PS544	3/8" Lock Washer	PS554	Main Gear	PS540	.055 Thrust Washer
PS560	1/4" Allen Head Cap Screw	PS562VPS	1/4" Breather Vent	PS565	Clutch Dog
P003NG	Motor Gear	PS563	Main Gear Housing	PS569	Clutch Housing
PS522	Transfer Housing Gasket	PS558	Worm Gear	PS518F	Plug
				PS537	Clutch Housing Plug

LIMITED WARRANTY

Pierce Arrow Inc. warrants that the goods, equipment, and merchandise manufactured by Pierce Arrow Inc. are free from defects in material and workmanship. The limited warranty includes replacement or repair of defective mechanical and electrical parts for a period of one year from the date of shipment by Pierce Arrow Inc.

OBTAINING WARRANTY SERVICE

Pierce Arrow Inc. must be notified of any defect before repair or replacement may be granted. The merchandise must be delivered by the purchaser to Pierce Arrow Inc. in Henrietta, Texas at the purchaser's expense. Any repairs not made by Pierce Arrow Inc. are not covered by the limited warranty and are the responsibility of the purchaser.

Pierce Arrow Inc. reserves the right to repair or replace defective parts or products in its sole discretion. The cost of any repairs not covered by the warranty will be charged to the purchaser.

EXCLUSIONS

All Pierce products are manufactured for a specific intended purpose. The Pierce Arrow Inc. limited warranty does not cover, and Pierce Arrow Inc. is not liable for, damage arising from any use other than the specific intended use of each product.

All coolers manufactured by Pierce are warranted for general cooling, and are not guaranteed to produce cooling sufficient for any specific purpose or for specific temperature. Pierce is not liable for any injury or damage arising from insufficiently cooled objects placed in the cooler, including but not limited to medications and perishables.

The Pierce Arrow Inc. limited warranty does not cover:

- Ongoing maintenance parts or repair due to normal wear and tear, and
- Any change or defect due to accident, misuse or any use for which the equipment was not intended, improper or unauthorized repair, failure to provide regular maintenance, and deterioration due to weather or road conditions.

Purchasers should consult their owner's manual for safety, installation, operation, and maintenance guidelines.

The Pierce Arrow Inc. limited warranty does not cover purchaser's cost of labor, transportation, shipping damages, installation or removal costs, down time, loss of profit or goodwill, or any other special, incidental, indirect, or consequential damages, concerning or related to any product or part, whether based upon negligence, strict liability, breach of contract, breach of warranty, misrepresentation, or any other legal theory.

Merchandise manufactured by Pierce Arrow Inc. is not designed or intended for the movement of people and are not to be used in the operation of elevators or other improper uses. Any improper use of the product may void the warranty.

OTHER MANUFACTURERS' WARRANTIES

Pierce Arrow Inc. makes no warranty, expressed or implied, to finished products manufactured or supplied by other manufacturers, and sold by Pierce Arrow Inc. to the purchaser, including but not limited to, any vehicle to which our product is affixed and any accessories. Such merchandise is subject to the manufacturer's warranty only, which will be provided upon request.

CONDITIONS OF SALE

When placing an order with Pierce Arrow Inc., the terms and conditions provided for payment, shipping, delivery and claims create an agreement between the purchaser and Pierce Arrow Inc. The agreement is to be performed in Clay County, Texas.

RETURNS: No returns are accepted without prior authorization. All items must be returned in their entirety. Please contact a sales representative for authorization. Upon authorization, returns must be shipped freight prepaid and may be subject to a 15% restocking fee. Please do not send returns COD. No returns will be accepted later than 30 days from the date of invoice.

DAMAGED GOODS: Pierce Arrow Inc. is not responsible for, and has no liability for:

- Damage arising during shipment
- Any change or defect due to accident, misuse or any use for which the equipment was not intended, improper or unauthorized repair, failure to provide regular maintenance, and deterioration due to weather or road conditions.

CLAIMS: Claims for breakage or damages during shipment must be made to the carrier at the time of delivery. If a signature is required, you must notify the driver and sign that there was damage. You must notify Pierce Arrow Inc. of the damage promptly so that a claim can be filed.