



DODGE DAKOTA
3" BODY LIFT
AUTO TRANS. ONLY
INSTALLATION INSTRUCTIONS
2005-2011 **KIT # 60163**

⚠ WARNING
Installation of a Performance Automotive Group body lift kit will change the vehicle's center of gravity and handling characteristics both on- and off-road. You must drive the vehicle safely! Extreme care must be taken to prevent vehicle rollover or loss of control, which could result in serious injury or death. Avoid sudden sharp turns or abrupt maneuvers and always make sure all vehicle occupants have their seat belts fastened.

⚠ WARNING
Before you install this kit, read and understand all instructions, warnings, cautions, and notes in this instruction sheet and in the vehicle owner's manual.

⚠ CAUTION
Proper installation of this kit requires knowledge of the factory recommended procedures for removal and installation of original equipment components. We recommend that the factory shop manual and any special tools needed to service your vehicle be on hand during the installation. Installation of this kit without proper knowledge of the factory recommended procedures may affect the performance of these components and the safety of the vehicle. We strongly recommend that a certified mechanic familiar with the installation of similar components install this kit.

⚠ WARNING
This kit should only be installed on a vehicle that is in good working condition. Before you install the kit, thoroughly inspect the vehicle for corrosion or deformation of the sheet metal around the factory body mounts. If the vehicle is suspected to have been in a collision or misused, do not install this kit. Off-road use of your vehicle with this kit installed may increase the stress applied to the factory body mounts. We do not recommend that any vehicle with a body lift kit installed be involved in any extreme off-road maneuvers such as jumping. Failure to observe this warning may result in serious personal injury and/or severe damage to your vehicle.

⚠ WARNING
Many states and municipalities have laws restricting bumper heights and vehicle lifts. Consult state and local laws to determine if the changes you intend to make to the vehicle comply with the law. Before combining a body lift with a suspension lift, consult an installation professional to see how this will affect the vehicle.

⚠ WARNING
The installation of larger tires may reduce the effectiveness of the Braking System.

⚠ WARNING
Always wear eye protection when operating power tools.

⚠ WARNING
Before you install this kit, block the vehicle tires to prevent the vehicle from rolling.

⚠ WARNING
Accidental deployment of the air bag can result in serious personal injury or death. To avoid accidental deployment during installation of the kit, the Supplemental Restraint System (SRS, or airbag) must remain deactivated. Do not allow anyone near the airbag during installation. Refer to the factory service manual or owner's manual for the recommended procedure to disable the SRS. After you install the kit, reactivate the SRS before driving the vehicle.

⚠ NOTE
Performance Automotive Group recommends using the Loctite® supplied in the kit on the threads of all kit nuts and bolts unless specified otherwise in these instructions.

Before Starting Installation

⚠ NOTE

Kit parts are prefaced by the word kit and appear in **bold** print.

1. Carefully read all warnings and instructions completely before beginning.
2. Verify all parts have been received in this kit by checking the parts list at the end of this document.

⚠ NOTE

If parts are missing from kit, please be prepared to provide the following information:

1. **Name** of purchase location
 2. **Bar Code** on side of box
 3. **Date** above bar code
 4. **Date** inside box cover
 5. **Inspector #** from inside box cover
3. **Only install this kit on the vehicle for which it is specified.** If anytime during the installation you encounter something different from what is outlined in the instructions, call technical support.
 4. Special tools needed:
 - a. Die grinder or similar tool capable of cutting thick plastic (lower fan shroud).
 5. Park the vehicle on a clean, dry, flat, level surface and block the tires so the vehicle cannot roll in either direction.

A. Measurements

1. Measure and record distance between front bumper and fenders.

Driver Side _____ Passenger Side _____

2. Measure and record distance between cab and bed.

Driver Side _____ Passenger Side _____

3. Measure and record distance between rear bumper and bed.

Driver Side _____ Passenger Side _____

B. Engine Compartment

1. Battery Cables

- a. Disconnect both battery cables. Disconnect negative cable first, then positive cable.

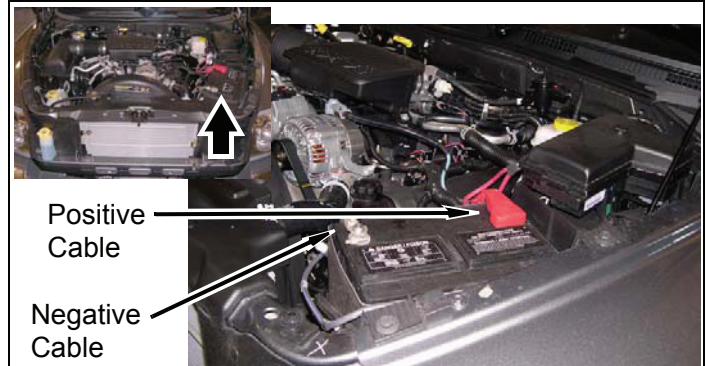

2. Airbag Fuse

⚠ NOTE

The location of the airbag fuse(s) may vary; check the owner's manual.

- a. Remove fuse box cover from fuse box.
- b. Remove three airbag fuses from fuse box.

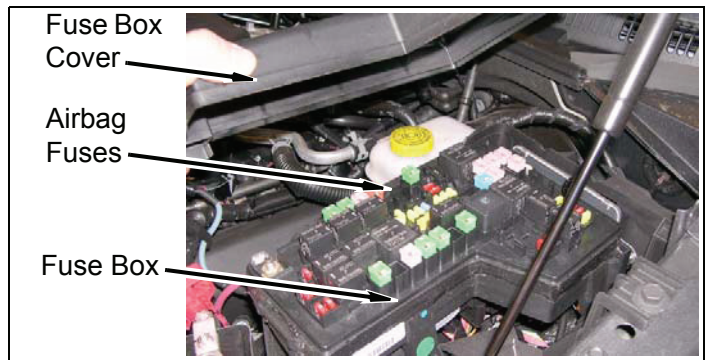

Prepare to Install Kit

A. Front of Vehicle

1. Driving Lights

- a. If equipped, disconnect wire harness connectors from driving lights.

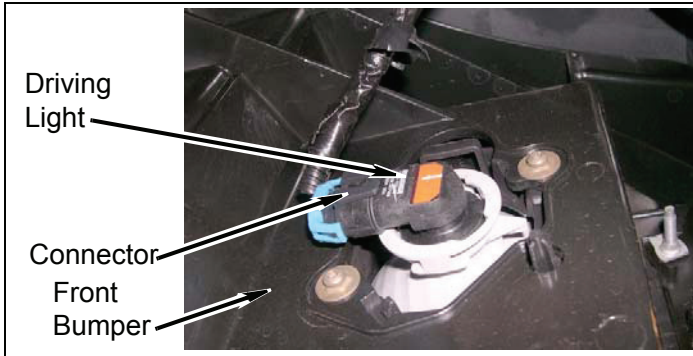

2. Front Bumper

- a. Remove seven push pins and lower radiator cover from core support and front bumper.

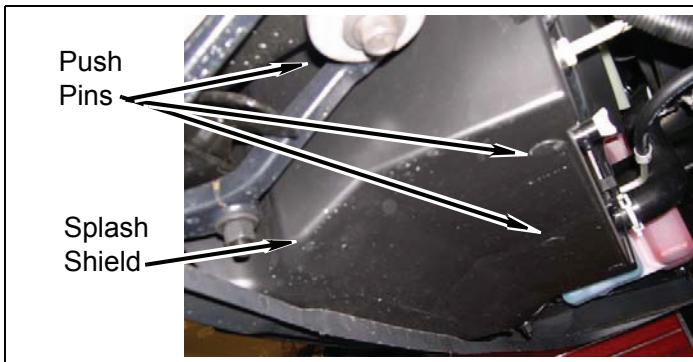

- b. Remove eight nuts, and front bumper from frame.

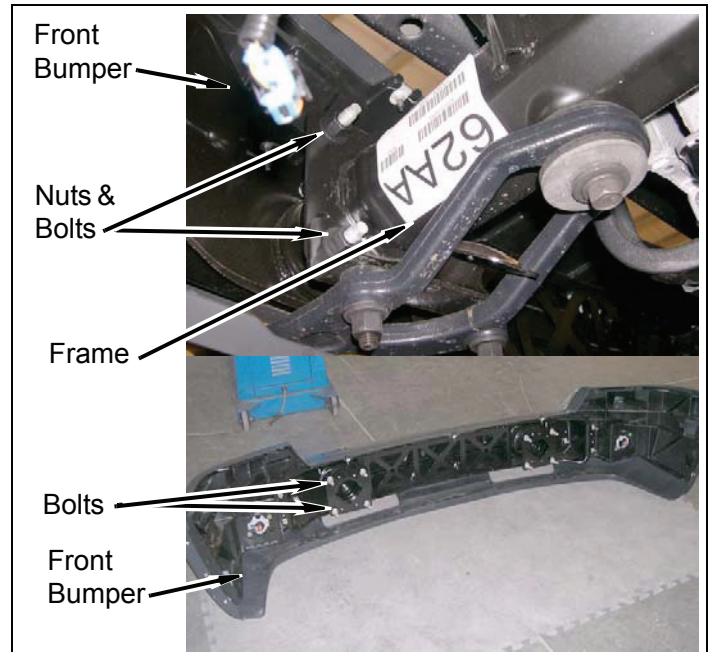

- c. Remove eight bolts from front bumper.

B. Engine Compartment

1. Splash Shield

- a. Remove five push pins and splash shield from core support.

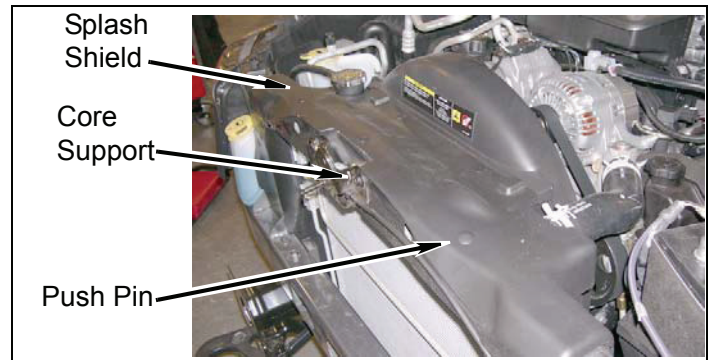

2. Radiator

- a. Remove two bolts and upper fanshroud from radiator.

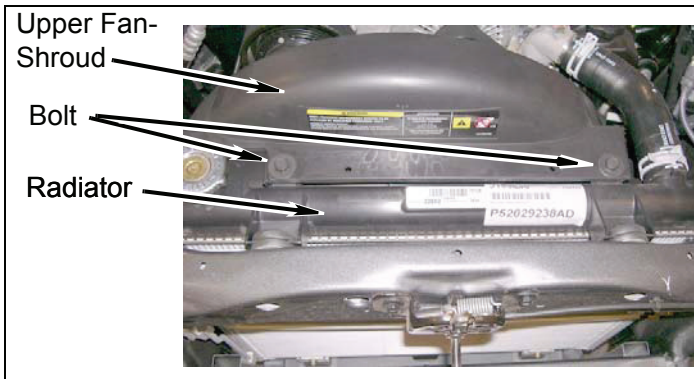

- b. Remove fan clutch assembly from engine.

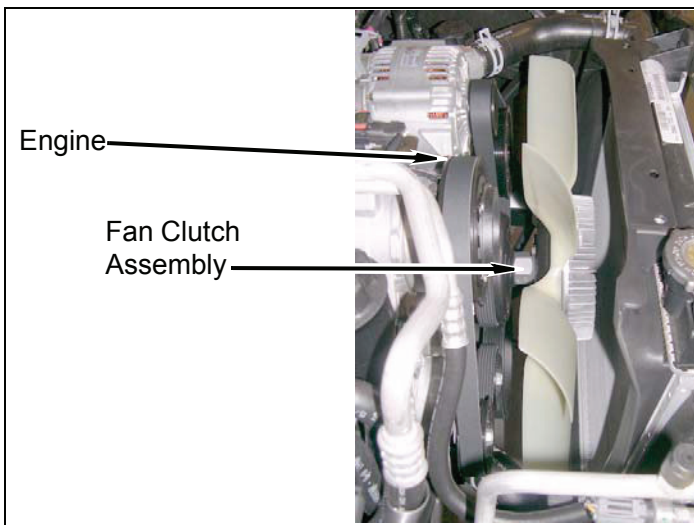

- c. Remove two bolts and radiator from core support.

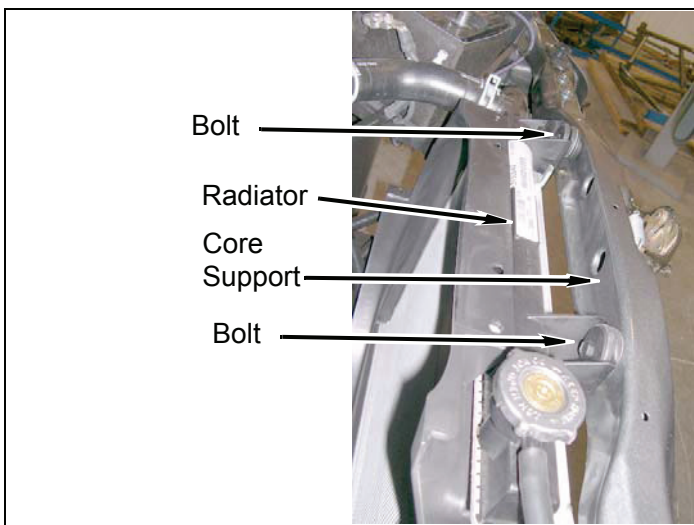

3. Air Box

- a. Loosen two clamps and remove air hose from air filter box and air intake box.

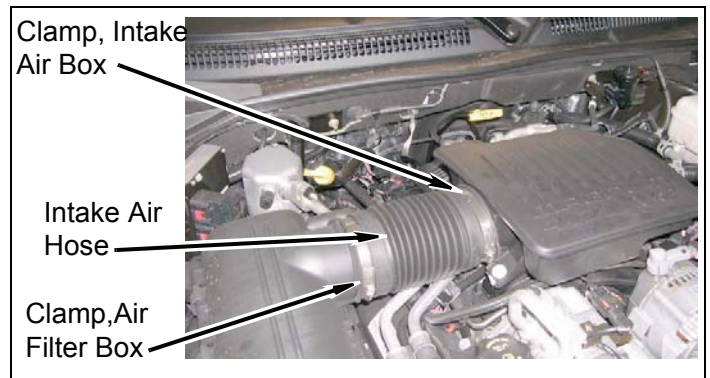

- b. Remove nut and air filter box from vehicle.

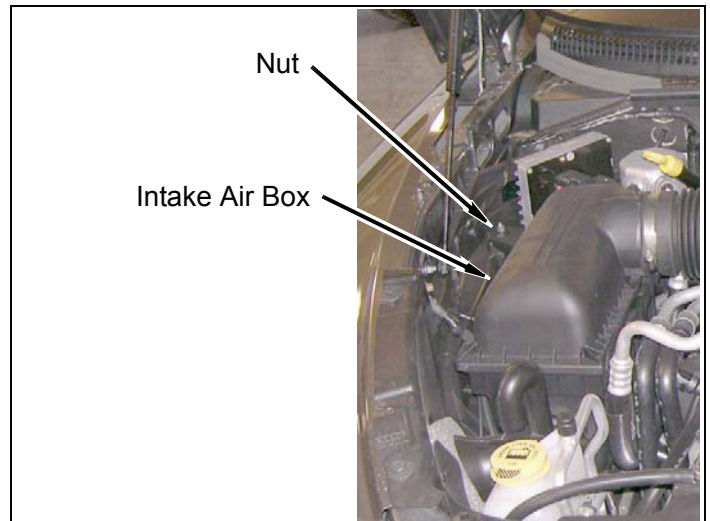

- c. Remove AC line and clip from inner fender well.

- d. Remove clip from AC line.

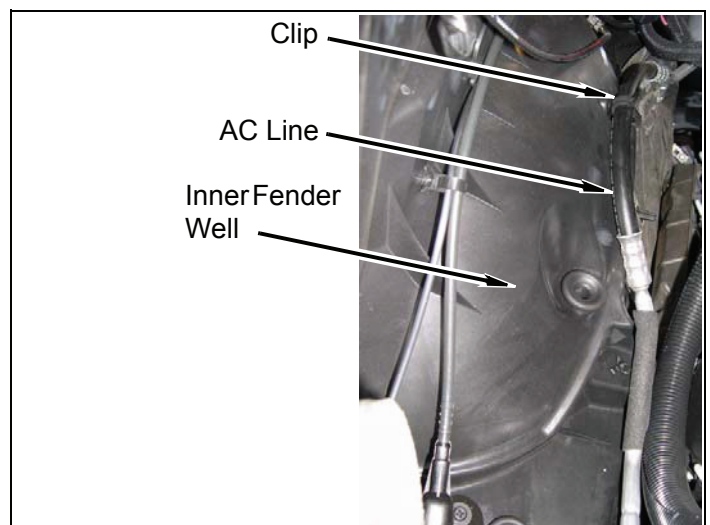

4. Fire Wall Ground Wires

- a. **Passenger Side:** Remove nut and ground wires from stud on firewall.

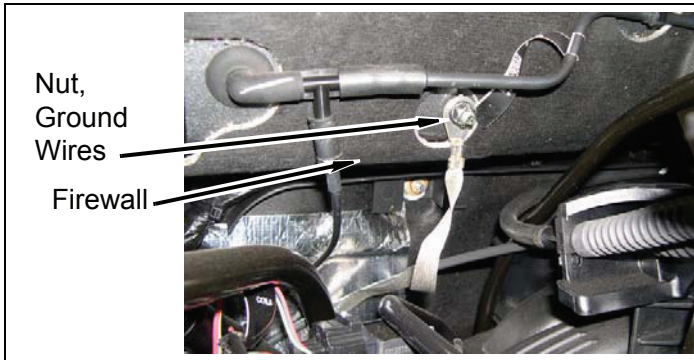

- b. Remove clip and wiring harness from fire wall.

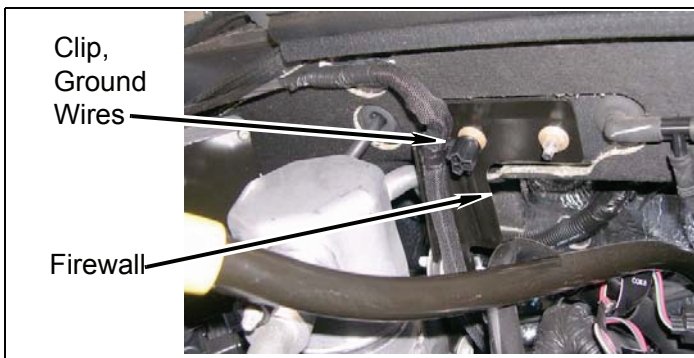

- c. **Driver Side:** Remove two nuts and vacuum control module from fire wall.



5. Steering Shaft

⚠ WARNING

Accidental deployment of the air bag can result in serious personal injury or death. To avoid accidental deployment during installation of the lift kit, the Supplemental Restraint System (SRS, or airbag) must remain deactivated. Do not allow anyone near the airbag during installation. Refer to the factory service manual or owner's manual for the recommended procedure to disable the SRS. After kit installation, the SRS must be reactivated before driving the vehicle.

⚠ CAUTION

If the following step is not performed, the airbag clock-spring could be damaged. Do not turn the steering wheel while the steering shaft is disconnected.

- a. Strap steering wheel to prevent accidental movement.
- b. Remove bolt from "U"-joint at upper steering shaft below brake booster.
- c. Pull "U"-joint off upper steering shaft.

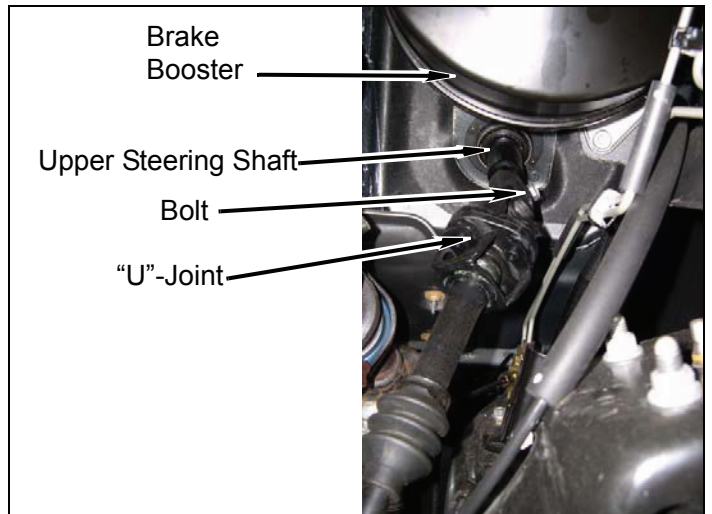

6. Automatic Transmission: Shift Cable

- a. Remove clip securing automatic transmission shift cable to frame near steering shaft.

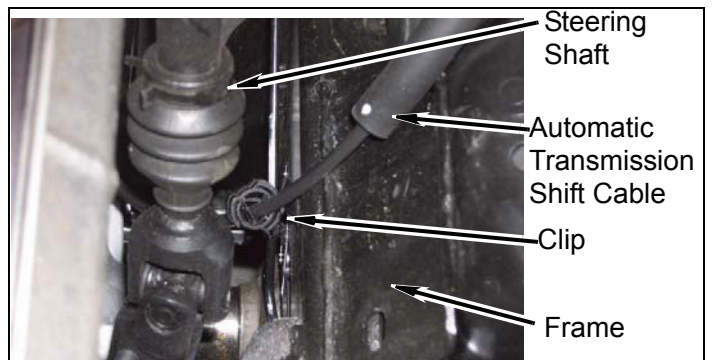

7. Radiator

- a. Using two jack stands as shown support radiator as shown.

- b. Measure down 3-1/4" from crossmember and cut radiator main braces as shown.

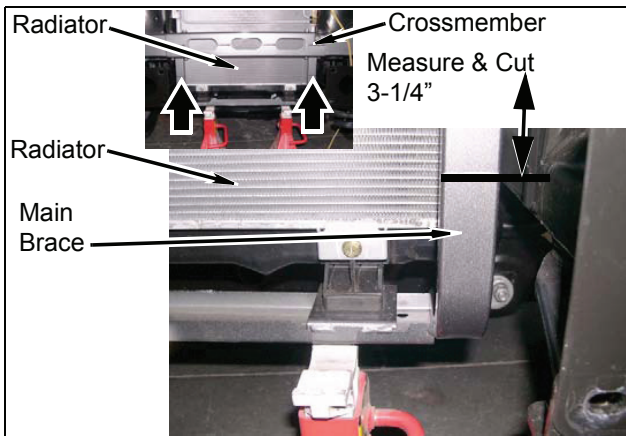

- c. Mark and cut rubber cover on driver side of radiator as shown.

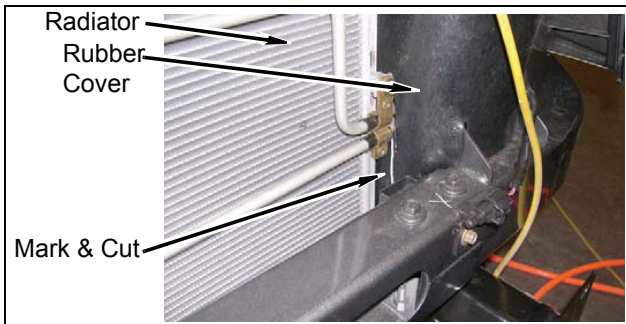

- d. Mark and cut rubber cover on passenger side of radiator as shown.

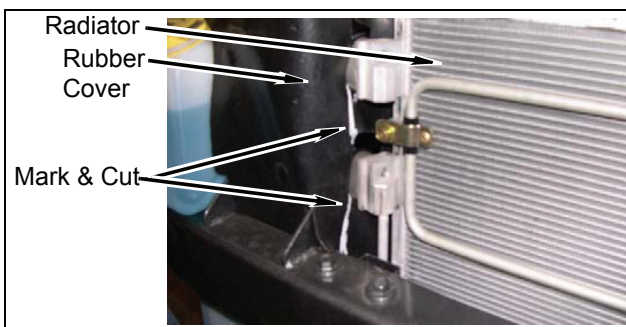

- e. Mark and trim passenger side core support under AC line, near core support body mount as shown.

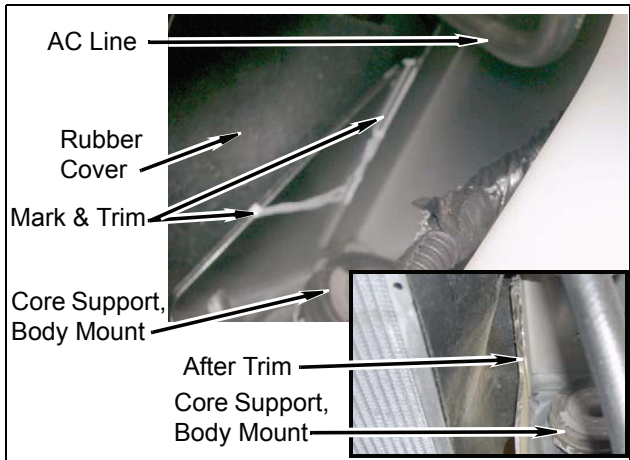

8. Positive Battery cable

- a. Remove positive battery cable and clip from frame as shown.

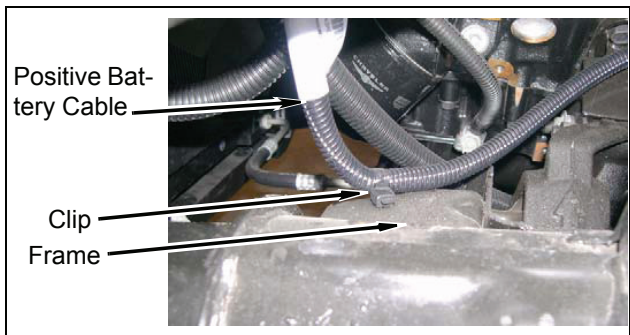

9. Front Fender Well

- a. Remove two bolts and brake distribution block bracket from frame.

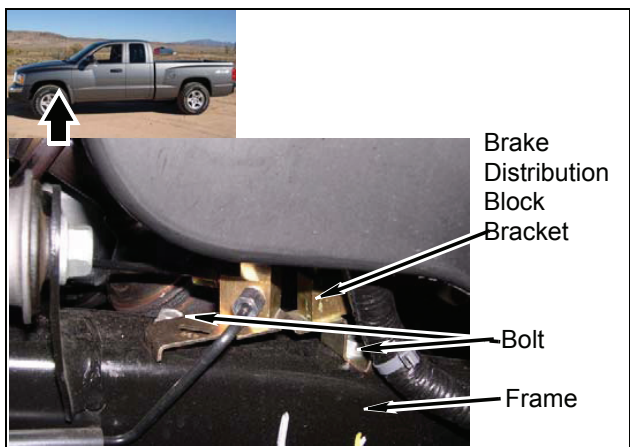

b. Remove bolt, ground wires, and clip from frame.

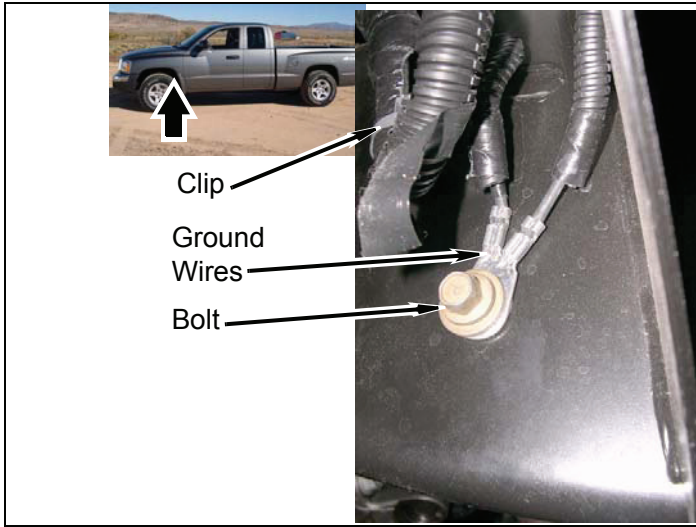

c. Remove front parking brake cable from frame cable mount.

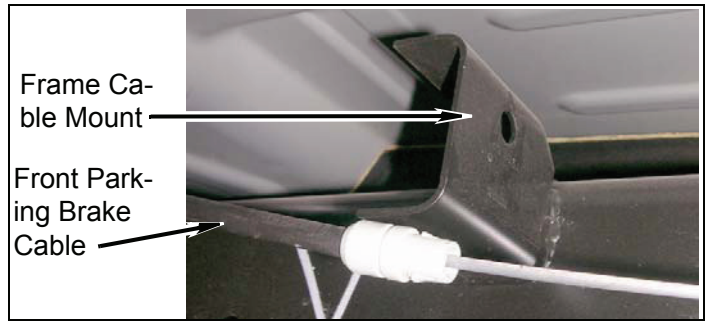

c. Remove brake line from clip on frame.

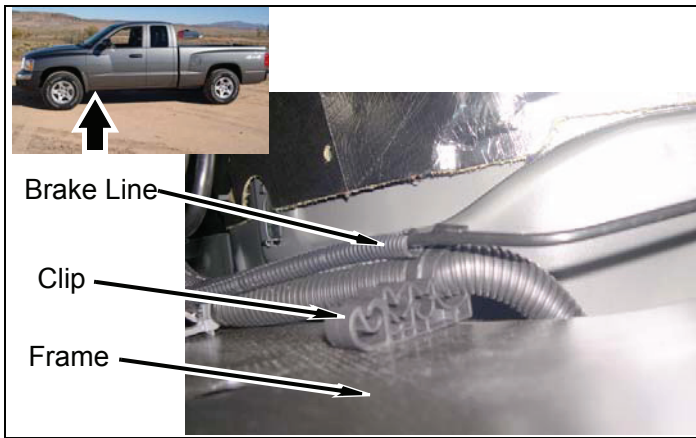

10. Parking Brake Cable

a. Pull slack in parking brake cable and clamp as shown at rear parking brake cable.

b. Remove front parking brake cable from cable connector and rear cable.

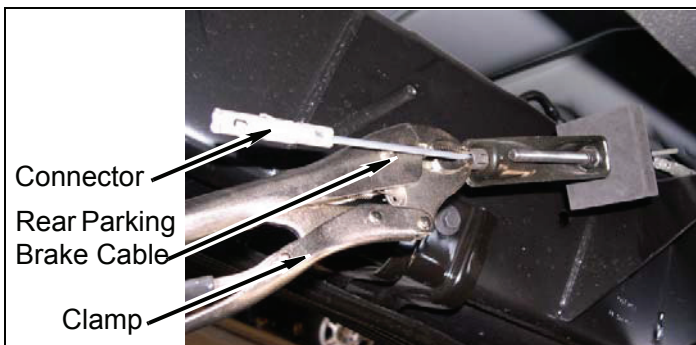

C. Rear of Vehicle

1. Fuel Filler

⚠ WARNING

Use extreme caution when working near fuel lines and fuel tank. Clean up spilled fuel immediately. A spark could cause an explosion or fire resulting in serious personal injury and property damage.

a. Remove gas cap.

b. Remove three torx screws from bed and fuel filler neck.

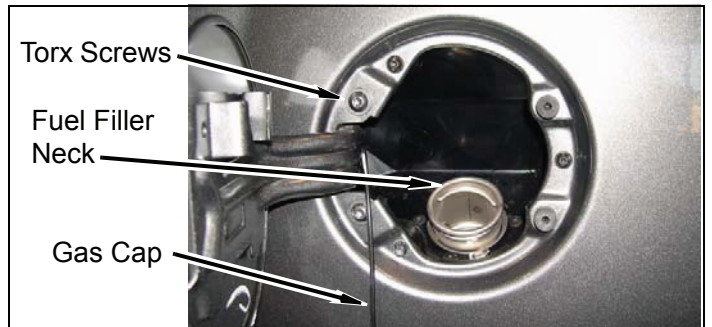

2. Spare Tire & Rear Bumper

a. Lower spare tire to ground (refer to owner's manual).

- b. Disconnect license plate light wiring harness connector from wiring harness and body.

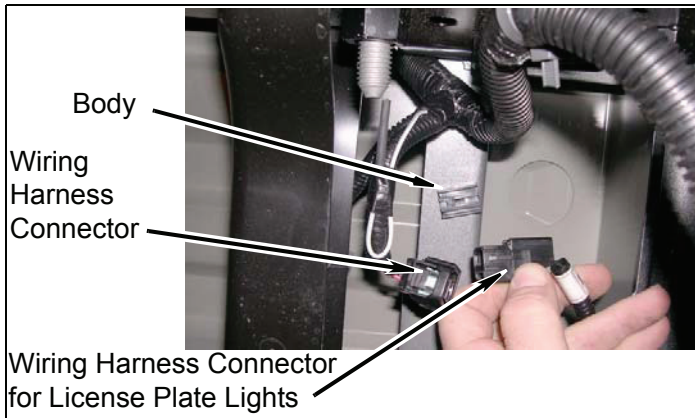

- b. Remove four bolts and lower bushings from cab mounts on passenger side.

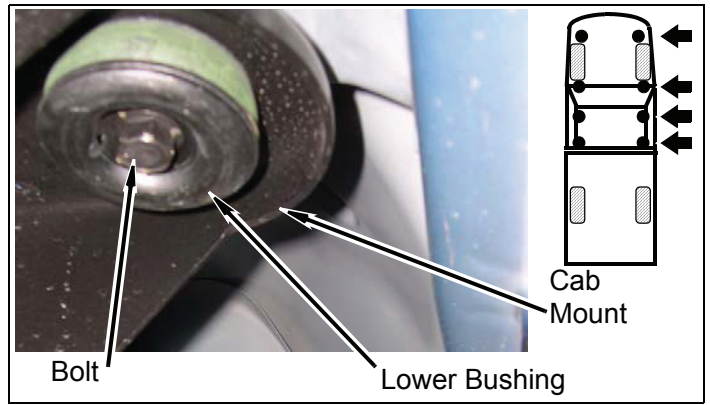

- c. Remove four nuts, two double bolt fasteners, and rear bumper from rear bumper brackets.

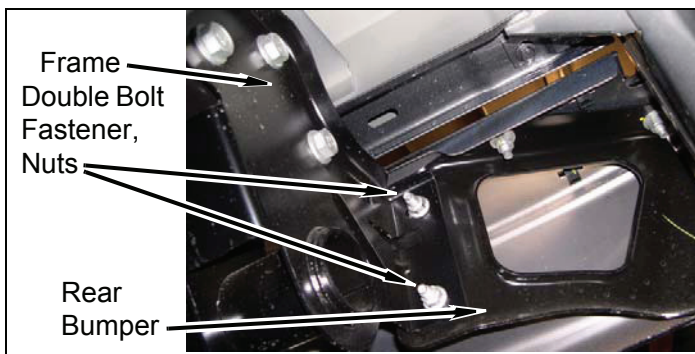

⚠ WARNING

Use extreme caution when lifting body from frame. To prevent serious personal injury, ensure the lifting device is securely placed. Keep your hands out from between the body and frame.

⚠ CAUTION

Before lifting the body, close the doors to prevent the body from flexing. When lifting the body, continually check hoses, wires, lines, etc. to be sure that everything is flexing properly and not binding, or damage to the vehicle could result. Be especially careful of the A/C hoses at the firewall and core support. Ensure brake lines stretch while lifting. Bending the lines to gain ample slack may be necessary. Be extremely careful not to kink the lines.

Install the kit

A. Cab

1. Lift Cab

- a. Loosen, but DO NOT remove, four cab mounting bolts on driver side (three bolts on vehicles with regular cab and extended cab).

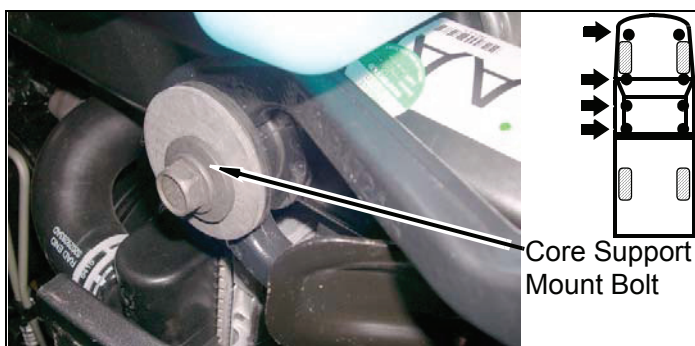

2. Cab Passenger Side

- a. Using a hydraulic jack and a wooden block spanning the last two or middle two body mounts as shown, slowly lift passenger side of cab a little over three inches.

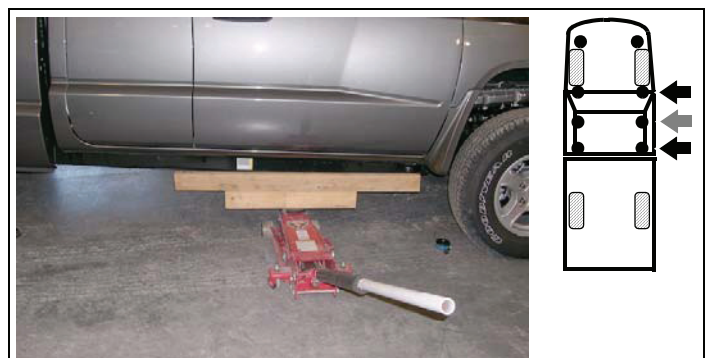

⚠ WARNING

The kit **blocks** must be installed in addition to the factory upper and lower bushings. Installing the kit **blocks** without the factory upper and lower bushings could result in damage to the vehicle or serious personal injury.

- b. Install a kit **block** (3" height x 3" diameter) on upper bushing at each cab mount.

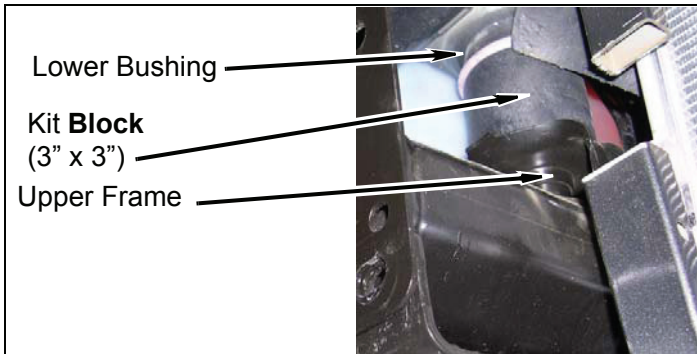

- c. Lower cab onto kit **blocks**.

- d. Remove two core support upper bushings from core support. Using a 1/2" drill bit remove threads from core support upper bushings and position upper bushings back on core support.

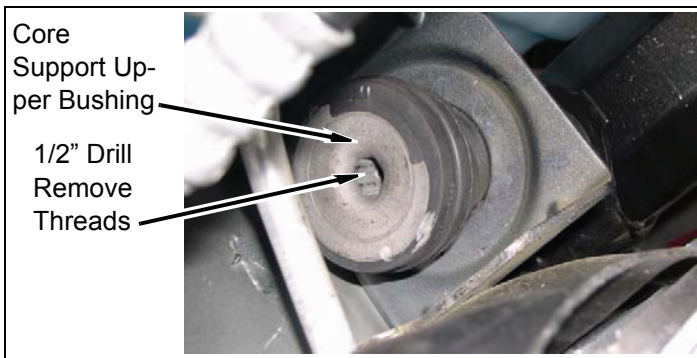

- e. Install kit **block** (3" x 3") on core support, upper and lower bushings, and tow hook bushing with a kit **bolt** (1/2-13 x 14"), a kit **washer** (1/2" thick), a kit **washer** (1/2" USS), and a kit **nut** (1/2" Nylock). DO NOT tighten.

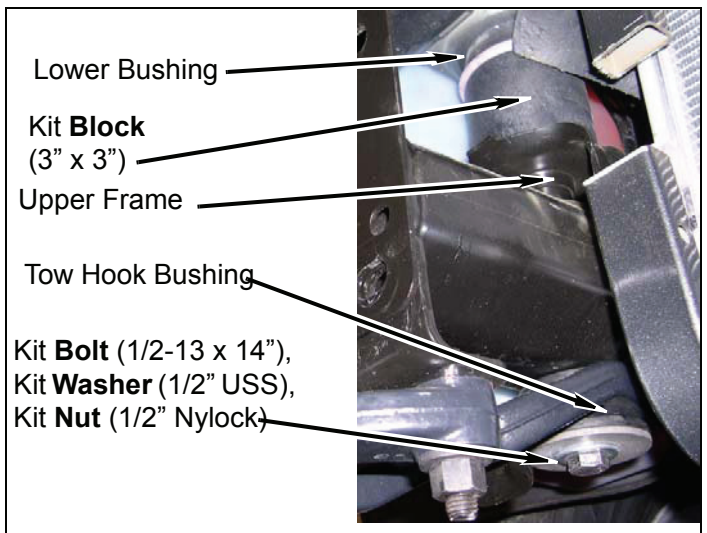
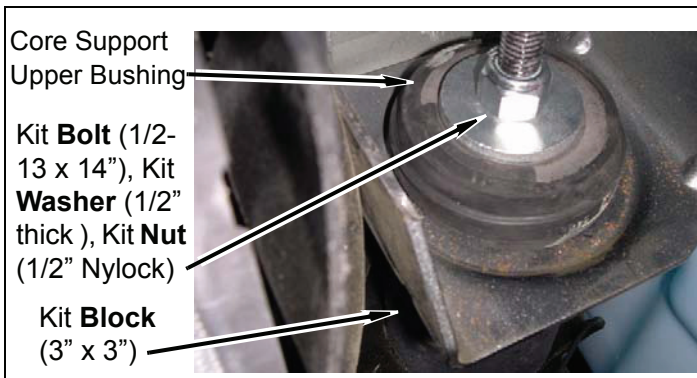

- f. Install a kit **bolt** (12mm-1.75 x 160mm) and a kit **washer** (1/2 SAE) at each remaining cab mount. DO NOT tighten.

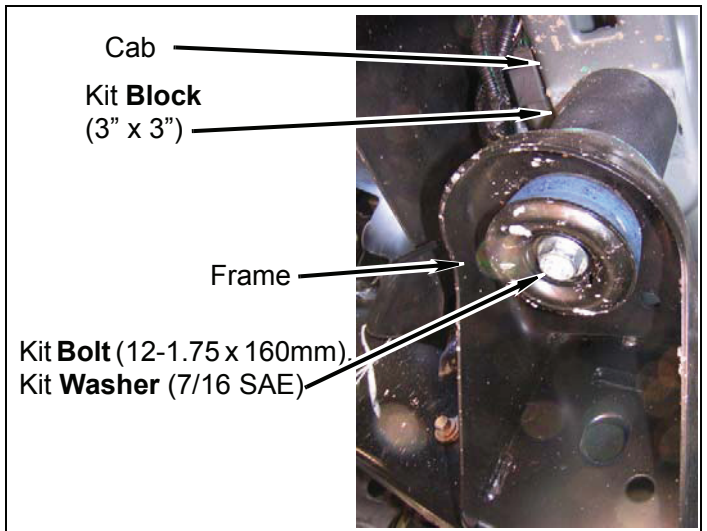

3. Cab Driver Side

- a. Repeat previous steps on driver side of cab.
- b. Remove each kit **bolt**, one at a time, and apply a few drops of Loctite® to threads. Install lower bushing, kit **washers** (1/2" USS & 1/2" SAE), and kit **bolts** (1/2-13 x 14" & 12mm-1.75 x 160mm). Tighten kit **bolt** to 55 lb.-ft.

B. Bed

1. Lift Bed

⚠ WARNING

Use extreme caution when lifting the bed from the frame. To prevent serious personal injury, ensure the lifting device is securely placed. Keep your hands out from between the bed and frame.

⚠ CAUTION

To prevent damage to the vehicle while lifting the bed, continually check hoses, wires, brake lines, etc. to ensure everything is flexing properly and not binding. Ensure clearance between bed and cab is maintained.

2. Bed

- a. Loosen, but DO NOT remove, four bed mounting bolts from bed and frame rail driver side.

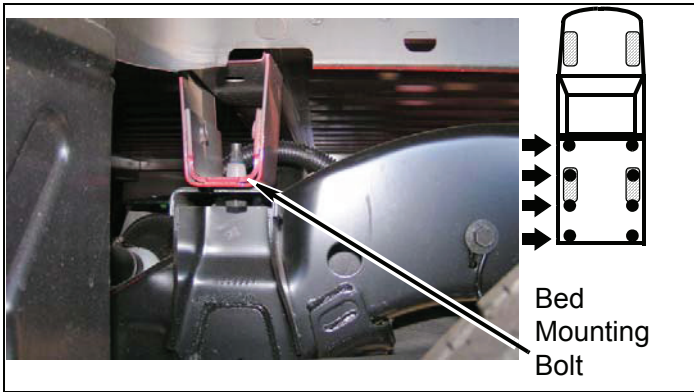

- b. Remove four bed mounting bolts from bed and frame rail passenger side.

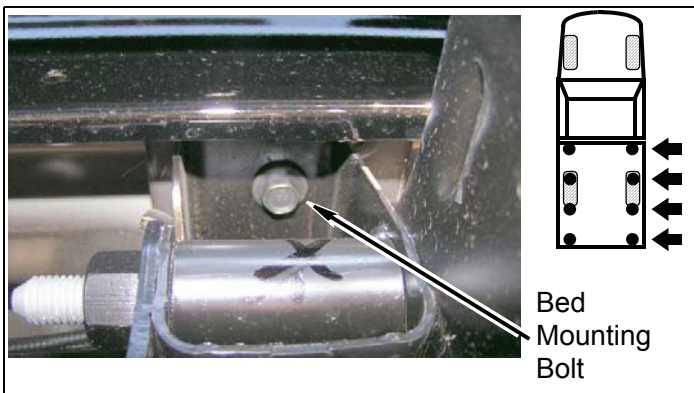

- c. Slowly lift passenger side of bed over three inches and install a kit **block** at each mount.

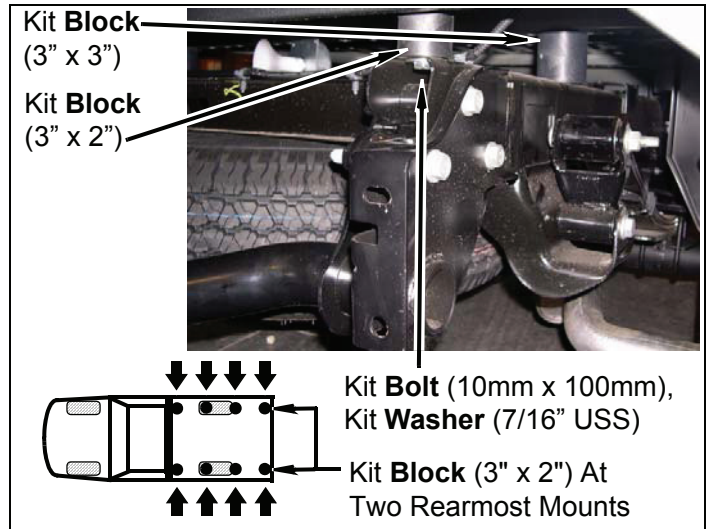

- d. Lower bed onto kit **blocks**.
- e. Install a kit **block** at each mount, with a kit **bolt** (10mm x 100mm) and kit **washer** (7/16" USS). DO NOT tighten.
- f. Set bed-to-cab spacing according to previous measurement.
- g. Remove each kit **bolt**, one at a time, and apply a few drops of Loctite® to threads. Install kit **bolt** with kit **washer** (7/16" USS). Tighten kit **bolt** to 35 lb.-ft.

C. Rear of Vehicle

1. Spare Tire Winch

- a. Remove three bolts and spare tire winch from mounting plate.

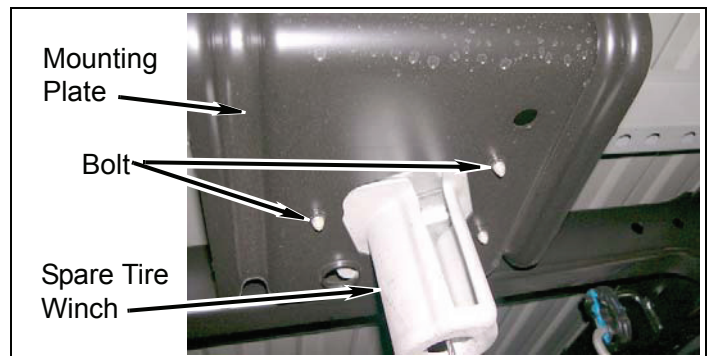

- b. Install spare tire winch on mounting plate with three kit **spacers**, three kit **bolts** (8mm x 100mm), and three kit **washers** (8mm).

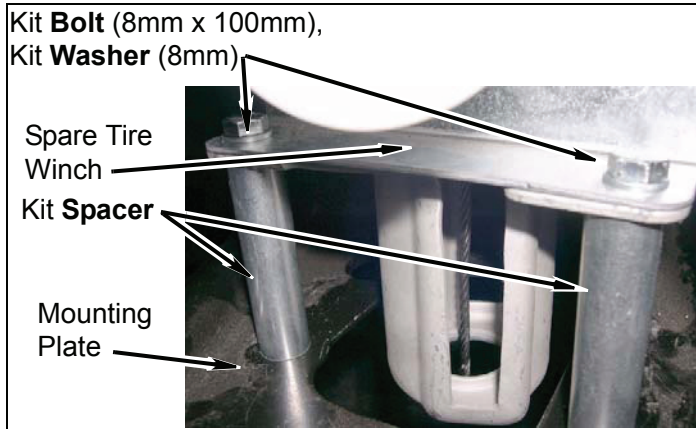

2. Rear Bumper

⚠ WARNING

The following procedure is intended only to enhance the appearance of the vehicle. The rear bumper will no longer be rated for towing of any kind. Towing with the rear bumper after it has been lifted can result in death, serious personal injury, or damage to the vehicle. Towing after the bumper has been lifted should be accomplished using a rated Class III receiver type hitch.

- a. Using kit **bracket** (rear bumper) as a template mark and trim bottom edge of bumper brackets to bend as shown.
- b. Using kit **bracket** (rear bumper) as a template align small hole as shown and install kit **bolt** (3/8"-16 x 1 1/2"), two kit **washers** (3/8 USS), and a kit **nut** (3/8" nylock) mark and drill a 3/8" hole in bumper brackets as shown. Do not tighten

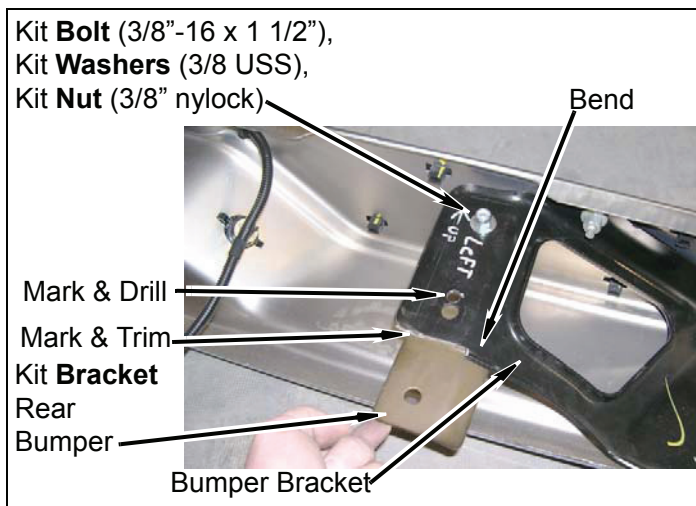

- c. Repeat for opposite side of rear bumper.

- d. Position rear bumper, kit **brackets** (rear bumper), and kit **washers** (rectangular) on rear bumper brackets with two double bolt fasteners and four nuts. Do not tighten.

- e. Adjust bumper clearance according to measurements taken earlier. Tighten nuts to 35 lb-ft.

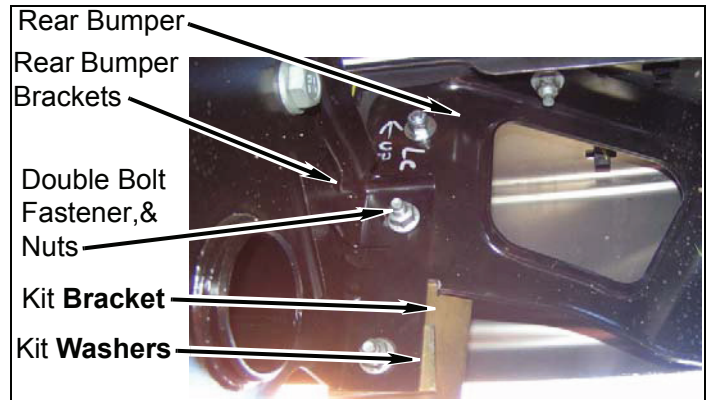

- f. Connect license plate light wiring harness connector to wiring harness.

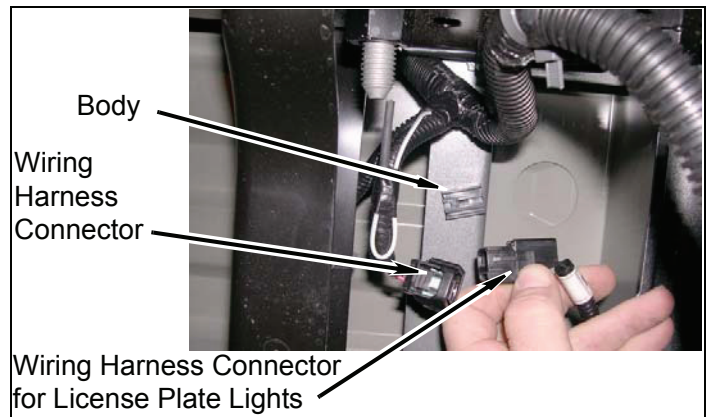

- g. Install spare tire.

3. Bed Spacers

- a. Install two kit **spacers** (bed) on frame with two kit **bolts** (5/16" x 1"), four kit **washers** (5/16" SAE), and two kit **nuts** (5/16" nylock).

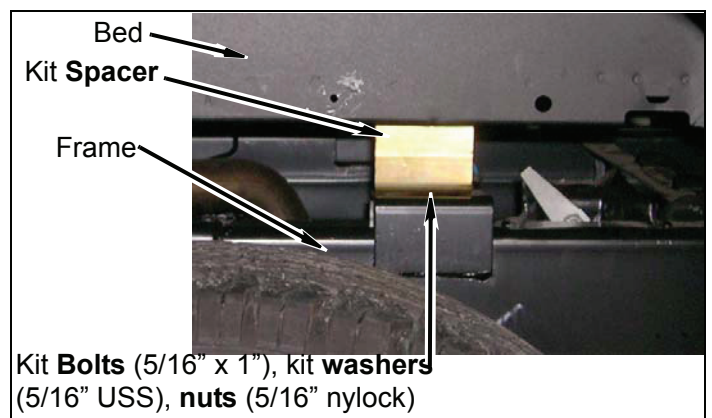

4. Fuel Filler

⚠ WARNING

Use extreme caution when working near the fuel lines and the fuel tank. Clean up spilled fuel immediately. A spark could cause an explosion or fire resulting in serious personal injury and property damage.

- a. Install fuel filler neck on bed with three screws.
- b. Install gas cap.

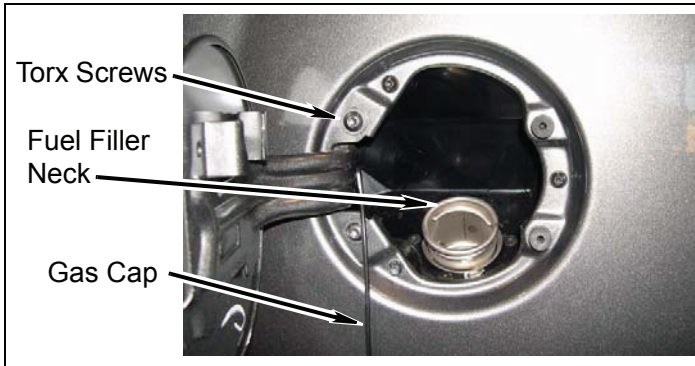

5. Parking Brake Cable

- a. Position front parking brake cable in frame cable mount.

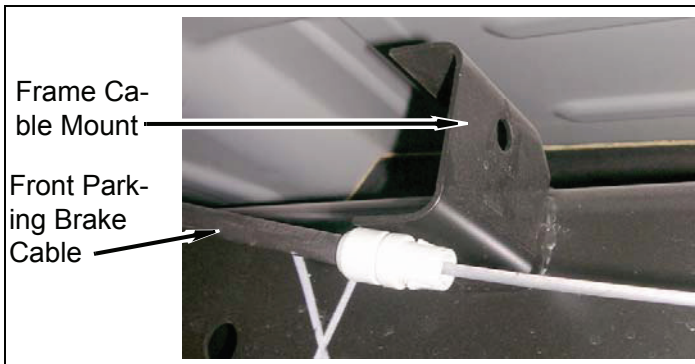

- b. Connect front parking brake cable and rear cable with cable connector.

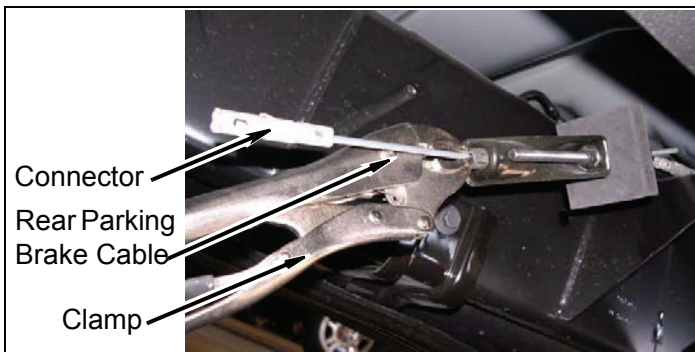

- c. Remove clamp from parking brake cable.

D. Front Fender Well

1. Brake Lines

- a. Install two kit **brackets** ("J"-shaped) on frame with two bolts.
- b. Install brake distribution block bracket on kit **brackets** with two kit **bolts** (1/4" x 1"), four kit **washers** (1/4" SAE), and two kit **nuts** (1/4" nylock).

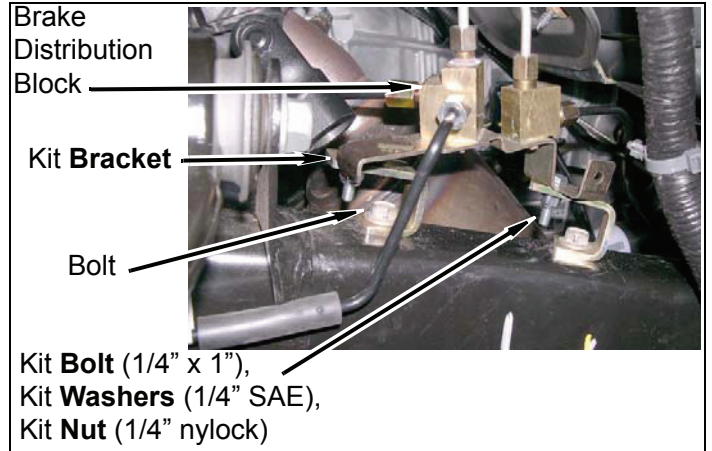

2. Ground Wires

- a. Install ground wires on frame with bolt.

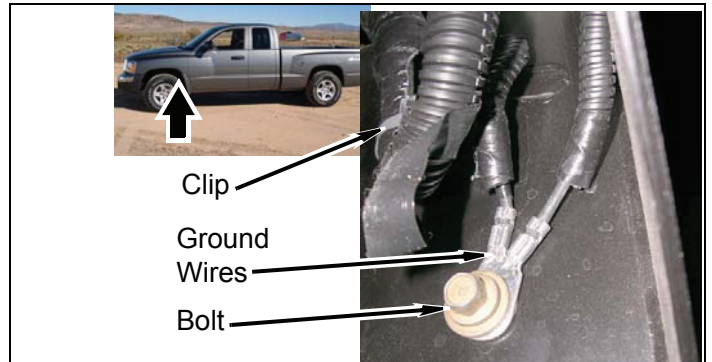

E. Engine Compartment

1. Automatic Transmission: Shift Cable

- a. If possible, secure automatic transmission shift cable to frame with clip.

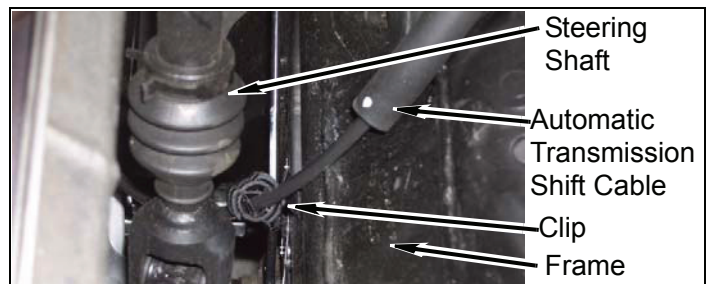

2. Steering Shaft

⚠WARNING

Ensure the kit **extension** (steering) is securely installed as specified in the instructions. Failure to do so may cause steering malfunction, resulting in loss of vehicle control.

- Install kit **extension** (steering) on upper steering shaft.
- Install intermediate steering shaft on kit **extension**.

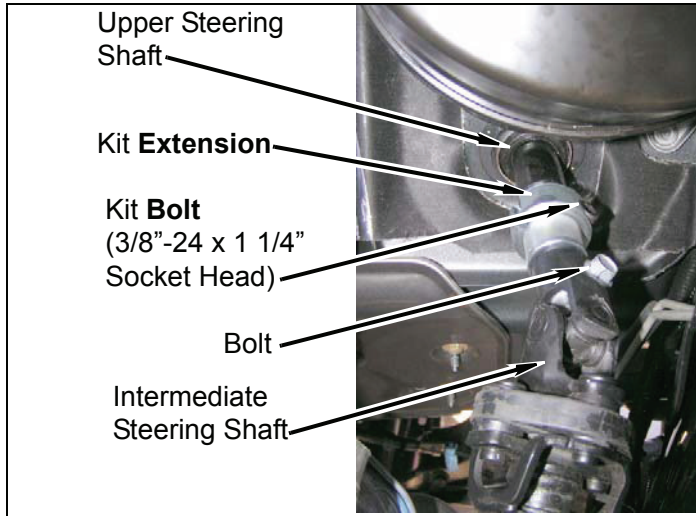

- Apply a few drops of Loctite® to kit **bolt** (3/8" x 1 1/4" Allen head) and factory bolt.
- Install and tighten kit **bolt** and factory bolt to 33 lb.-ft.

3. Lower Radiator

- Mark a line on kit **extension** (radiator), 1-1/2" from each end as shown.

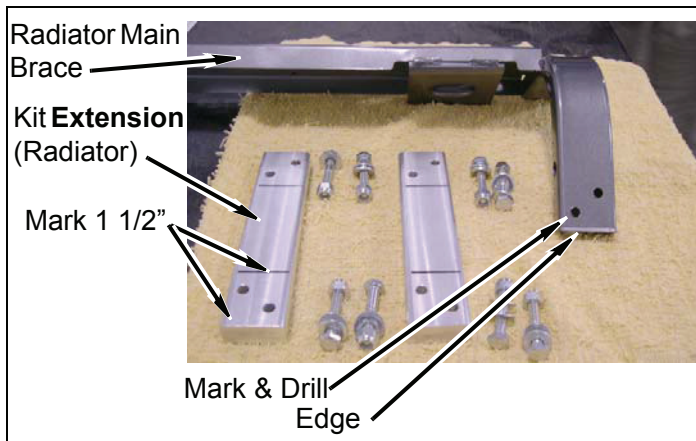

- Remove radiator main brace from radiator and jack stands. Support radiator with jack stands.
- Position kit **extension** (radiator) up against radiator main brace as shown using marked line and edge mark holes and drill radiator main brace as shown.
- Position kit **extension** (radiator) up against remaining radiator main brace on vehicle, using marked line and cut edge, mark holes and drill remaining radiator main brace as shown.
- Install two kit **extensions** (radiator) in radiator main brace with four kit **bolts** (1/4" x 1"), eight kit **washers** (1/4" SAE), and four kit **nuts** (1/4" nylock).
- Position radiator main brace on jack stands, under radiator, and in the remaining radiator main braces.
- Install two kit **extensions** (radiator) and radiator main brace in remaining radiator main braces with four kit **bolts** (1/4" x 1"), eight kit **washers** (1/4" SAE), and four kit **nuts** (1/4" nylock).

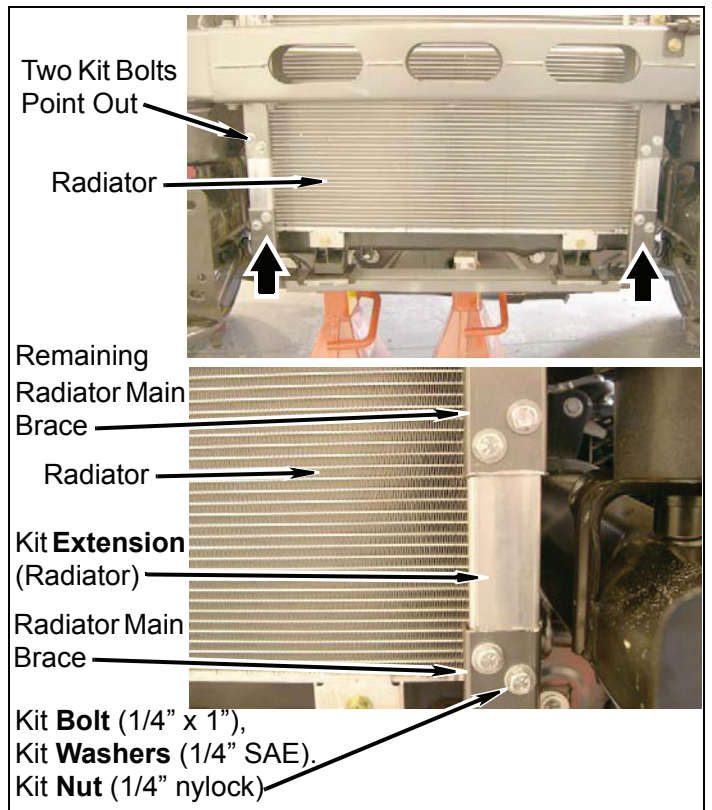

4. Fan Shroud

- a. Install fan clutch assembly on engine.

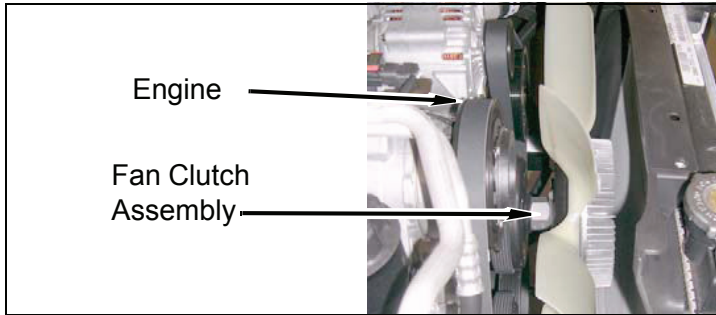

- b. Install upper fan shroud on radiator with two bolts. Ensure distance between fan blades and fan shroud is even all the way around.
- c. Install radiator on core support with two kit brackets (radiator), bolts, two kit **bolts** (8mm x 30mm), four kit **washers** (8mm), and two kit **nuts** (8mm nylock).

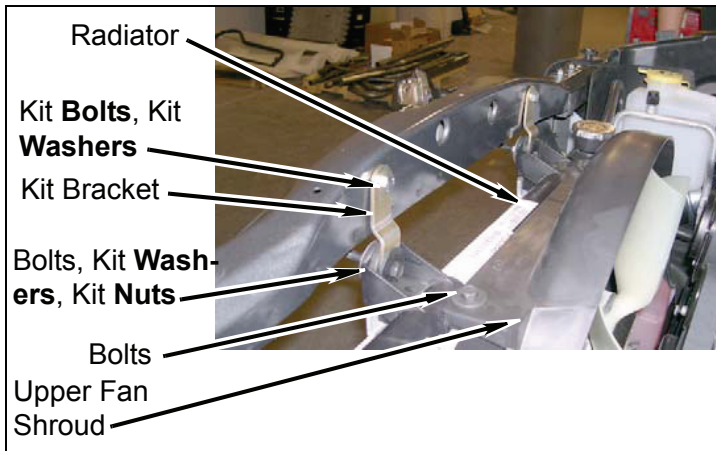

5. Ground Wires

- a. **Passenger Side:** Install kit **extension** (firewall ground strap) on firewall with nut.
- b. Install ground wire on stud of kit **extension** with kit **nut** (1/4" nylock) and kit **washer** (1/4" SAE).

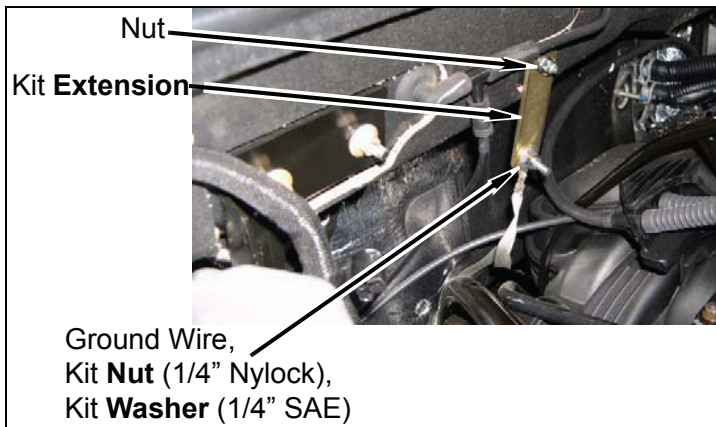

6. Air Filter Box

- a. Install AC line clip in the rear most hole of air filter box as shown.
- b. Position AC line in AC line clip on air filter box.

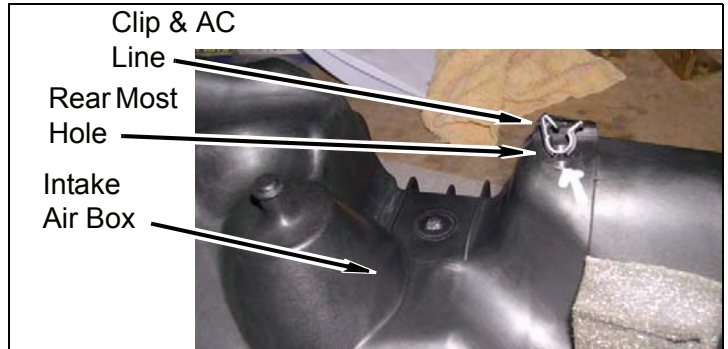

- c. Install air filter box on passenger side fender well with a nut and two nipples.

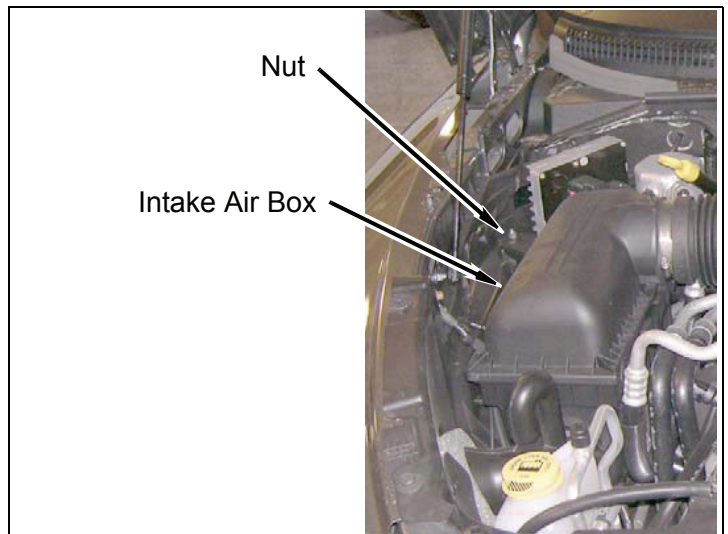

- d. Loosen bolt from intake air box to bracket on driver side of engine.
- e. Remove bolt and "U"-nut holding intake air box to bracket on passenger side of intake air box.

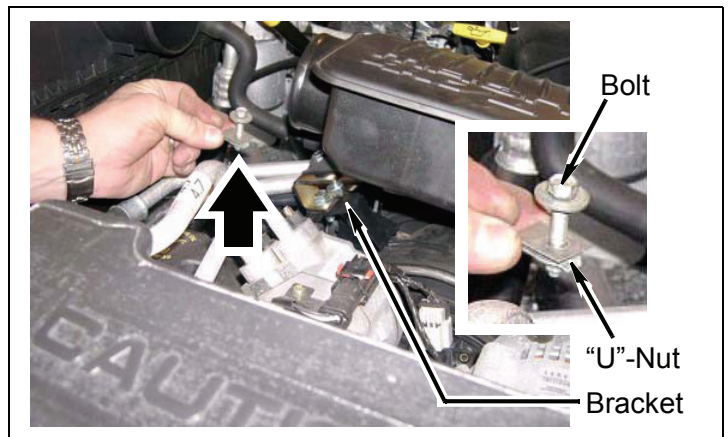

- f. Install kit **bracket** (“J”-shaped) on engine with kit **“U”-nut** (5/16”) and kit **bolt** (5/16” x 1”).

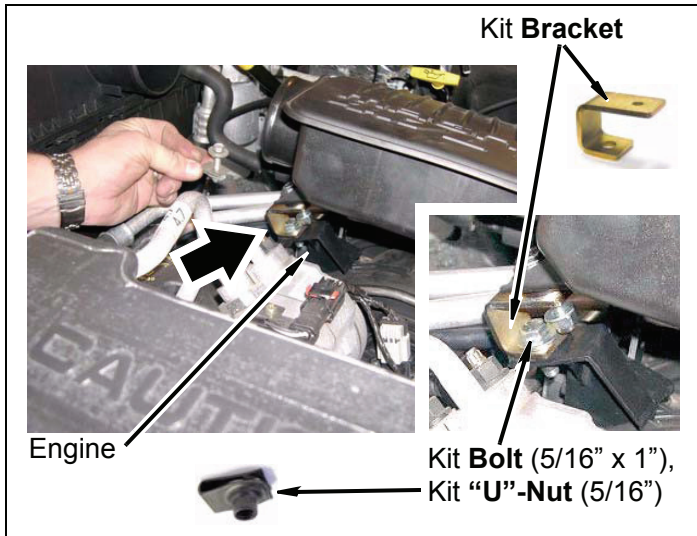

7. Install intake air box on kit **bracket** (“J”-shaped) with kit **bolt** (1/4” x 1 1/2”), kit **washer** (1/4” SAE), and kit **nut** (1/4” nylock).

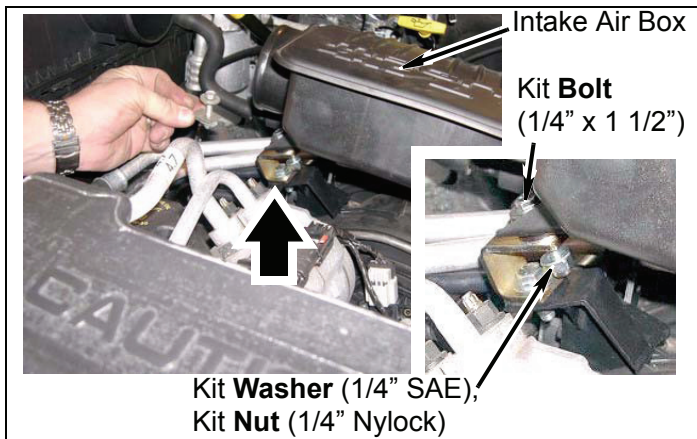

8. Intake Air Hose

- a. Connect intake air hose to intake air box and air filter box. Tighten clamps securely.

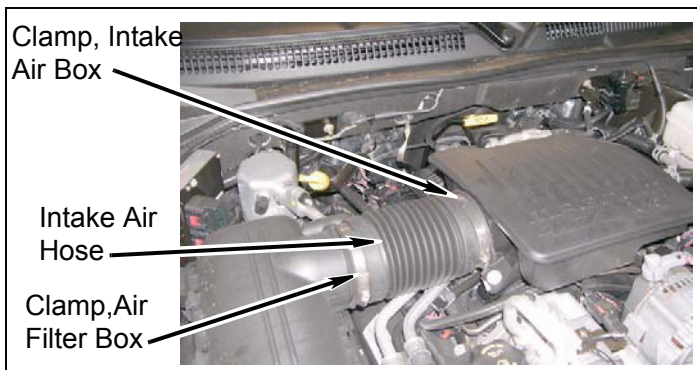

F. Front of Vehicle

1. Front Bumper

- a. Using kit **bracket** (front bumper) as a template, position upside down and mark front bumper vailence where interference occurs and trim as shown. Repeat for both front bumper mounts.

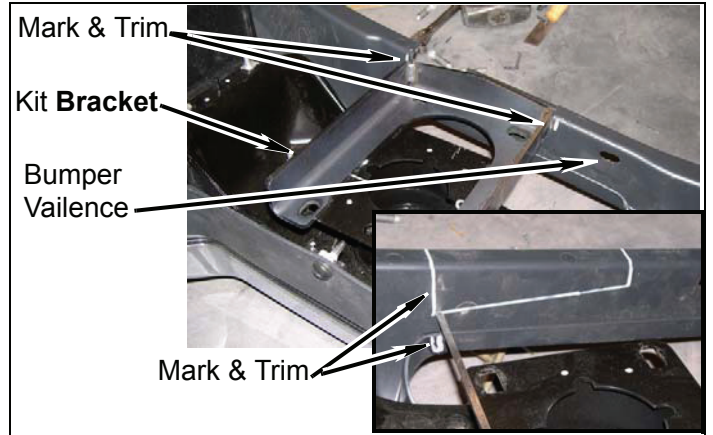

- b. Position two kit **brackets** (front bumper) on front bumper under mounting plate as shown. Some tapping may be required.

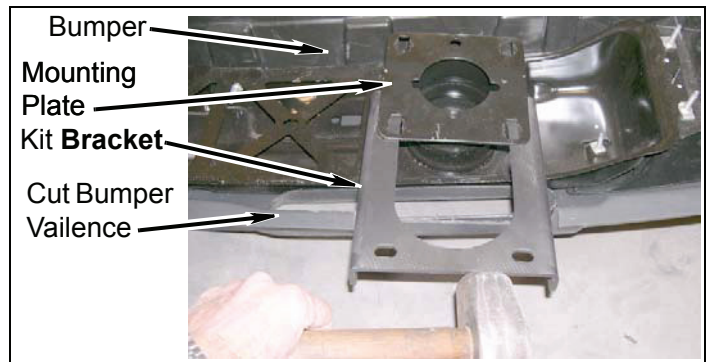

- c. Position two kit **brackets** (front bumper) on frame behind mounting plate and in front of tow hook bracket as shown. Some tapping may be required.

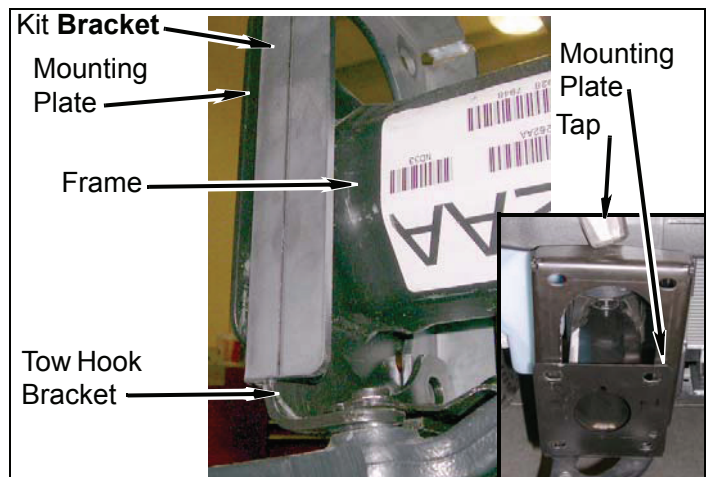

- d. Lift front bumper up into position, and install four **brackets** (front bumper) and front bumper mounting plates (top holes) with four bolts and four nuts.

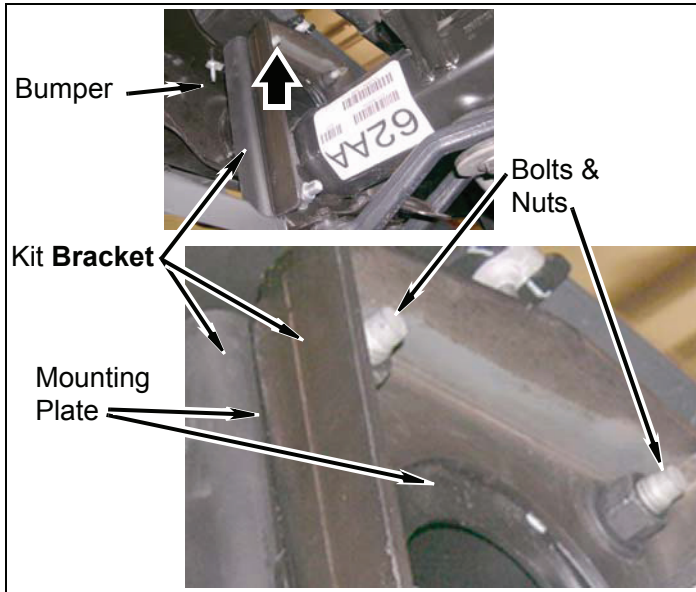

- e. Install four **kit brackets** (front bumper) on frame mounting plate (bottom holes) and tow hook brackets with four **kit bolts** (1/2" x 2"), eight **kit washers** (1/2" SAE), and four **kit nuts** (1/2" nylock). Do not tighten.

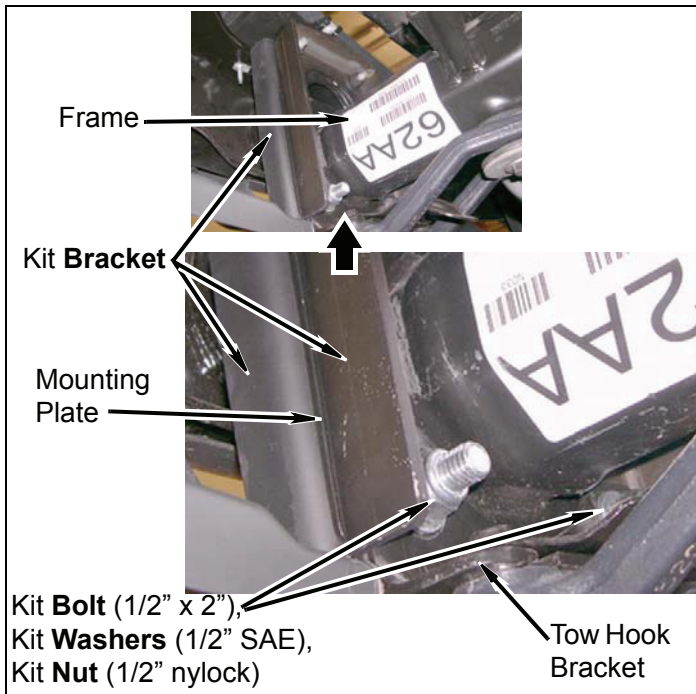

- f. Adjust front bumper to body measurements recorded earlier. Tighten bolts to 55 lb-ft.

- g. Position splash shield under core support and front bumper, mark two new push clip hole locations as shown.

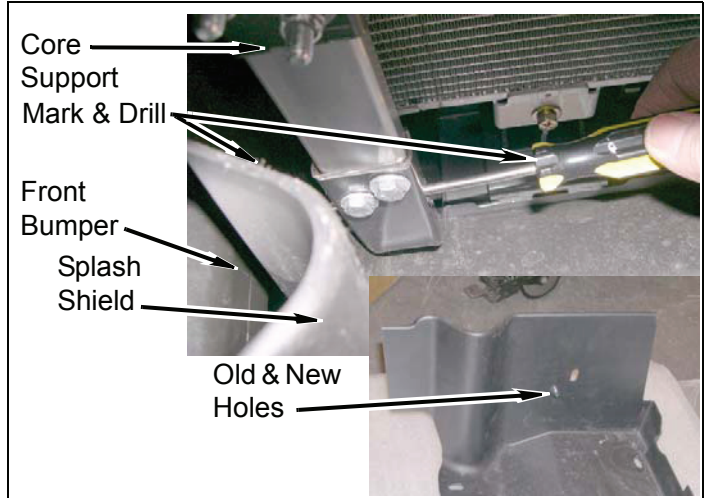

- h. Drill holes where marked and install splash shield on core support and front bumper with five push pins.

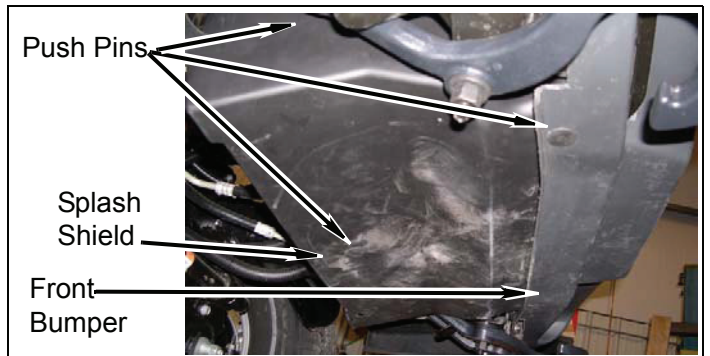

2. Driving Lights

- a. If equipped, connect wire harness connectors to driving lights.

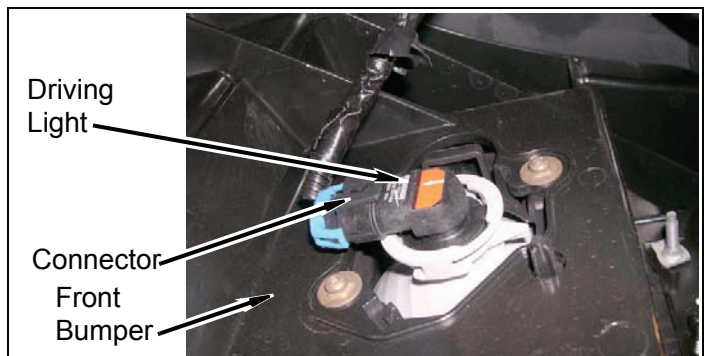

After Completing Installation

A. Engine Compartment

1. Fuse Box
 - a. Install two airbag fuses.
 - b. Install fuse box cover.

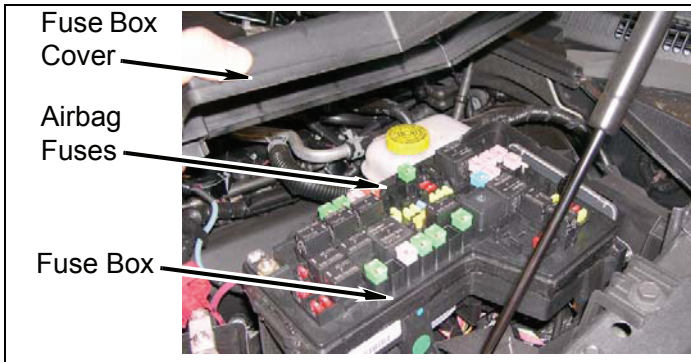

2. Battery Cables

- a. Connect both battery cables. Connect positive cable first, then negative cable.

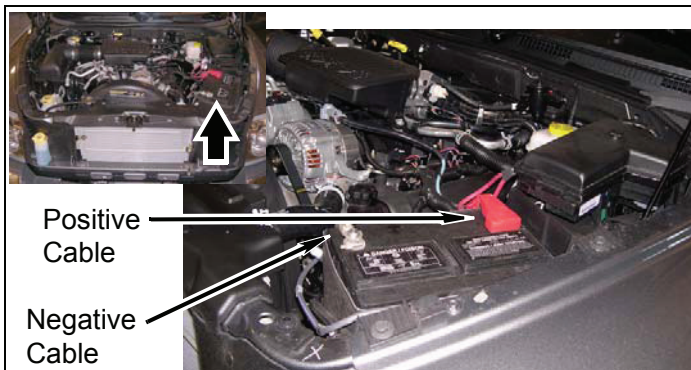

B. Miscellaneous

1. Apply kit **label** (warning) to dashboard in plain sight of all vehicle occupants.
2. Check all fasteners to ensure they are tight.

3. Ensure all wires, hoses, cables, etc. are properly connected and there is ample slack.

⚠WARNING

If the engine cooling system is hot, the coolant will be HOT and UNDER PRESSURE. To prevent serious personal injury, wait until the cooling system is completely cool before removing the cap from the radiator.

4. Start engine and top off cooling system. Purge air from cooling system according to manufacturer's instructions. Install radiator cap.

C. Dynamic Vehicle Check

1. Test-drive vehicle. Check steering in both directions to ensure that there is no bind. Check operation of clutch, brake system, and parking brake. Check operation of transmission and transfer case. Ensure there is full engagement in all gears and 4WD ranges.
2. Check operation of all electrical accessories.

⚠WARNING

Retorque all fasteners after 500 miles and after off road use. All body lift components should be visually inspected and fasteners retorqued during routine vehicle servicing.

⚠CAUTION

Performance Automotive Group does not recommend any particular wheel and tire combinations for use with its body lifts and cannot assume responsibility for the customer's choice of wheels and tires. Refer to your owner's manual for recommended tire sizes and warnings related to the use of oversized tires. Larger wheel and tire combinations increase stress and wear on steering and suspension components, which leads to increased maintenance and higher risk for component failure. Larger wheel and tire combinations also alter speedometer calibration, braking effectiveness, center of gravity, and handling characteristics. Consult an experienced local off road shop to find what wheel and tire combinations work best with your vehicle.

⚠NOTE

All warranty information, instruction sheets, and other documents regarding the installation of this product must be retained by the vehicle owner. Information contained in the instructions and on the warranty card will be required for any warranty claims. The vehicle owner needs to understand the modifications made to the vehicle and how they affect vehicle handling and performance. Failure to provide the vehicle owner with this information can result in damage to the vehicle and severe personal injury.

Kit Parts List

Qty.	Description
2	Block , 3" height x 2" diameter
14	Block , 3" height x 3" diameter
2	Bolt , 8mm-1.25 x 30mm
3	Bolt , 8mm-1.25 x 100mm
8	Bolt , 10mm-1.50 x 100mm
6	Bolt , 12mm-1.75 x 160mm
2	Bolt , 1/2"-13 x 14"
2	Bolt , 1/4" x 1"
9	Bolt , 1/4" x 1 1/2"
1	Bolt , 3/8"-24 x 1 1/4" socket head
2	Bolt , 3/8"-16 x 1 1/2"
5	Bolt , 5/16" x 1"
4	Bolt , 1/2" x 2"
1	Bracket , firewall ground strap
2	Bracket , front bumper (frame)
2	Bracket , front bumper (bumper)
3	Bracket , "J"-shaped
2	Bracket , rear bumper
2	Bracket , "Z"-shaped
2	Extension , radiator
1	Extension , steering
6	Nut , 1/2" Nylock
4	Nut , 5/16" Nylock
2	Nut , 3/8" Nylock
16	Nut , 1/4" Nylock
2	Spacer , bed
3	Spacer , spare tire winch
1	"U"-Nut , 5/16"
7	Washer , 8mm
26	Washer , 1/4" SAE
8	Washer , 5/16" SAE
8	Washer , 7/16" USS
4	Washer , 3/8" USS
2	Washer , 1/2" USS
14	Washer , 1/2" SAE
2	Washer , 1/2" thick
2	Washer , Rectangular