



*Paramount
Automotive*



2017 Product Catalog



Since 2008 Paramount Automotive has provided automotive enthusiasts with innovative, stylish, and high quality products at extremely competitive pricing. As a leading industry manufacturer, we have integrated Robotic Welding and CNC equipment into our relentless pursuit of increasing product quality and reliability. Driven by feedback from our customers, sales staff, and customer service, our engineers and design team work diligently to develop perfect product that launches the absolute latest trends and improvements for a wide variety of vehicles and restyling tastes.

Whether you drive a Truck, Jeep, or SUV, Paramount Automotive understands your basic desire and design a vehicle that matches your particular style, personality, and interests. If you're a hard core dedicated off-roader, or simply prefer to cruise the local boulevard looking good, Paramount Automotive has an impressive selection of products to display the proper attitude and flair.

At Paramount Automotive, our goal is to constantly expand, improve, and refine the quality of our products. And also constanly improve the customer service. With assistance from our highly valued customers, we feel confident that Paramount Automotive will continue to develop more high quality products that promote sustained market growth well into the future.



TABLE OF CONTENTS

- 02. About Paramount Automotive
- 03. Table of Contents
- 04. 15-17 Ford F-150 Raptor Style Series
- 05. 09-14 Ford F-150 Raptor Style Series
- 06. Ford Trucks' Raptor Style Grilles
- 07. Evolution Cut-out Mesh Grille Inserts
- 08. Evolution LED Packaged Grilles
- 09. Evolution LED Insert Grilles
- 10. Evolution Black Packaged Grilles
- 11. Evolution Chrome Shell/Black Mesh Packaged Grilles
- 12. Black Mesh Packaged Grilles
- 13. Chrome Mesh Packaged Grilles
- 14. Billet Packaged Grilles
- 15. Billet Grilles
- 16. Truck Winch Bumpers
- 17. Heavy Duty Truck Winch Bumpers
- 18. Truck Running Boards
- 19. Truck Running Boards Cont.
- 20. Truck Aluminum Running Boards
- 21. Truck Aluminum Running Boards Cont.
- 22. Truck LED Bull Bars
- 23. Truck Fender Flares
- 24. Traildriver JK Fender Flares
- 25. JK Fender Flares
- 26. JK Tubular Doors
- 27. JK Tubular Safari Doors
- 28. JK Side Steps
- 29. JK Rock Sliders
- 30. JK All Weather Floor Liners
- 31. JK Grille Guard/Bull Bar
- 32. JK "Tailgate" Rear Bumper
- 33. JK Steel Tire Carriers
- 34. JK Web Series Bumper
- 35. JK Modular Front Bumper
- 36. JK Stinger Bumpers
- 37. JK Full Width LED Bumpers
- 38. JK LED Bumpers
- 39. JK LED Bumpers Cont.
- 40. Full Width Bumpers w/Fog Light Housing
- 41. Full Width Rear Bumpers
- 42. JK Stubby Bumpers
- 43. JK Front Bumpers w/Fog Light Housing
- 44. JK Tubular Bumpers
- 45. JK Rock Crawler Bumpers
- 46. TJ,YJ,CJ Rock Crawler Armor
- 47. TJ,YJ Rock Slider
- 48. TJ, YJ Rock Crawler Bumpers
- 49. TJ, YJ Rock Crawler Bumpers Cont.
- 50. TJ, YJ Tubular Bumpers
- 51. TJ, YJ Classical Bumpers
- 52. TJ,YJ Fender Flares
- 53. Jeep Wrangler Light Mounting Brackets
- 54. Jeep Wrangler Grilles
- 55. Jeep Wrangler Grilles Cont.
- 56. Jeep Wrangler Soft Goods
- 57. Jeep Wrangler Accessories
- 58. Contractor Racks
- 59. Contractor Racks Cont.
- 60. Contractor Racks Cont.
- 61. Professional Racks
- 62. Jeep Wrangler JK Light Guards
- 63. Terms and Conditions

15-17 Ford F-150 Raptor Style Series

Paramount Automotive Raptor Style Grille, Bumper, and Fender Flares transform a 2015-2017 Ford F-150 from a stock truck into a stunning Raptor replica. An injection molded grille complete with amber LED lights and cold-formed steel bumper are finished in the same charcoal grey paint. ABS plastic fender flares complete the Raptor look . These parts together or separately will create a distinct style for any F-150.

FEATURES

- New 2017 Raptor style design grille, bumper, and fender flare.
- High quality custom-designed amber LED lights.
- Wire harness for LED lights are included in 41-0157.
- Cold-formed steel bumper.
- Charcoal gray painted finish on grille and bumper.
- Paintable black finish on fender flare.
- Easy bolt-on installation.
- 90 Days limited warranty on LED lights.

PART#	APPLICATION
41-0157	ABS New Raptor Style Packaged Grille
57-0182	Raptor Style Front Bumper
58-0411	Raptor Style Fender Flare Styleside (Short, Standard and Long Bed)
54-3024	Raptor Style Bumper Fog Light Mounting Double LED Bracket with 4X12w LED Lights



41-0157



57-0182



58-0411



54-3024





Paramount Automotive Raptor Style Grille, bumper and fender flares transform a 2009-2014 Ford F-150 from a stock truck into a stunning Raptor replica for a nominal price. An injection molded grille complete with amber LED lights and cold-formed steel bumper are finished in the same charcoal grey paint. ABS plastic fender flares complete the Raptor look. These parts together or separately will create a distinct style for any F-150.

FEATURES

- New 2017 Raptor style design grille, bumper, and fender flare.
- High quality custom-designed amber LED lights.
- Wire harness for LED lights are included in 41-0158..
- Cold-formed steel bumper.
- Charcoal gray painted finish on grille and bumper.
- Paintable black finish on fender flare.
- Easy bolt-on installation.
- 90 Days limited warranty on LED lights.

PART#	APPLICATION
41-0158	ABS New Raptor Style Packaged Grille
57-0180	Raptor Style Front Bumper
58-0410	Raptor Style Fender Flare Styleside (Short, Standard and Long Bed)
54-3025	Raptor Style Bumper Fog Light Mounting Double LED Bracket with 4X12w LED Lights



41-0158



57-0180



58-0410



54-3025



Ford Trucks Raptor Style Grilles

Paramount Automotive created the Raptor Style Grilles to enable Ford truck owners of multiple generations to participate in the Raptor Style. These injection molded grilles come equipped with amber LED lights and then are tastefully finished in grey charcoal paint to give an enhanced front end appearance to any Ford truck.

FEATURES

- New 2017 Raptor style design grille.
- High quality custom-designed amber LED lights.
- Wire harness for LED lights are included.
- Charcoal gray painted finish on ABS.
- Easy installation – replaces OE grille assembly.
- 90 Days limited warranty on LED lights.



41-0159 04-08 Ford F-150



41-0160 11-16 Ford F-250/F-350



41-0161 08-10 Ford F-250/F-350

PART#	YEAR	MAKE	MODEL
41-0159	04-08	Ford	F-150
41-0160	11-16	Ford	F-250/F-350
41-0161	08-10	Ford	F-250/F-350
41-0162	05-07	Ford	F-250/F-350



41-0159 04-08 Ford F-150



41-0162 05-07 Ford F-250/F-350



41-0160 11-16 Ford F-250/F-350



41-0162 05-07 Ford F250/F350F-250/F-350



41-0163 99-04 Ford F-250/F-350



41-0161 08-10 Ford F-250/F-350



41-0163 99-04 Ford F-250/F-350



Paramount Automotive Evolution Insert Grilles offer the same look as our Packaged Grilles at a much lower price. These riveted black grilles easily make your truck stand out from the crowd.

FEATURES

- Chrome rivets provide a rugged off-road appearance.
- 100% 304 Stainless steel.
- Fully formed woven mesh adds elegant look.
- Black textured powder coat finish.
- Cut-out the factory grille insert for installation.



46-0701 11-16 Ford F-250/F-350



46-0757 14-15 Chevy Silverado 1500



46-0759 13-17 Dodge Ram 1500



46-0760 14-17 Toyota Tundra



46-0734 11-14 GMC Sierra 2500/3500



46-0770 15-17 Ford F-150



46-0757 14-15 Chevy Silverado 1500



46-0759 13-17 Dodge Ram 1500



46-0760 14-17 Toyota Tundra



46-0734 11-14 GMC Sierra 2500/3500



Upper Grille	Bumper Grille	YEAR	MAKE	MODEL
46-0701	46-0740	11-16	Ford	F-250/F-350
46-0703	46-0745	08-10	Ford	F-250/F-350
46-0704	46-0746	05-07	Ford	F-250/F-350
46-0770	46-0777	15-17	Ford	F-150
46-0702	46-0744	09-14	Ford	F-150
46-0767	46-0768	10-14	Ford	F-150 SVT Raptor
46-0780		15-16	Chevy	Avalanche/Suburban/Tahoe
46-0709		07-14	Chevy	Avalanche/Suburban/Tahoe
46-0757	46-0758	14-15	Chevy	Silverado 1500(2PCS)
46-0765	46-0758	14-15	Chevy	Silverado 1500(4PCS)
46-0733	46-0725	07-13	Chevy	Silverado 1500
46-0763		15-17	Chevy	Silverado 2500/3500
46-0730	46-0741	11-14	Chevy	Silverado 2500/3500
46-0708		07-10	Chevy	Silverado 2500/3500
46-0773		14-16	Chevy	Colorado
46-0759		13-17	Dodge	Ram 1500
46-0717		09-12	Dodge	Ram 1500
46-0766		13-17	Dodge	Ram 2500/3500
46-0729		10-12	Dodge	Ram 2500/3500
46-0779	46-0778	07-14	Toyota	FJ Cruiser
46-0760		14-17	Toyota	Tundra
46-0720		10-13	Toyota	Tundra
46-0721		07-09	Toyota	Tundra
46-0762		12-16	Toyota	Tacoma
46-0722	46-0754	05-11	Toyota	Tacoma
46-0755		14-15	GMC	Sierra 1500
46-0712	46-0726	07-13	GMC	Sierra 1500
46-0734	46-0743	11-14	GMC	Sierra 2500/3500
46-0713		07-10	GMC	Sierra 2500/3500
46-0764		15-17	GMC	Yukon
46-0769		15-17	GMC	Sierra 2500/3500
46-0774		14-16	GMC	Caynon

Evolution LED Packaged Grilles

Paramount Automotive Evolution LED Packaged Grilles are precision manufactured allowing owners to easily replace their factory grille with a gorgeous and functional upgrade. Simply remove the OE grille and replace it with the Paramount Automotive Evolution LED packaged grille. You can even store your OE grille in the Paramount Automotive box for safe keeping. These grilles come complete with built in LED lights that look great and perform even better.

FEATURES

- Chrome rivets provide a rugged off-road appearance.
- Custom-designed OE Style ABS shell in gloss black finish.
- Black textured powder coat finish on grille insert.
- Grille insert built from 100% 304 Stainless steel.
- Powerful LED lights come pre-installed.
- Wire harness and swith for LED lights are included.
- Easy installation – replaces OE grille assembly.
- 90 Days limited warranty on LED lights.



12W Square LED light 72W LED light Bar



48-0850 15 -17 Ford F-150

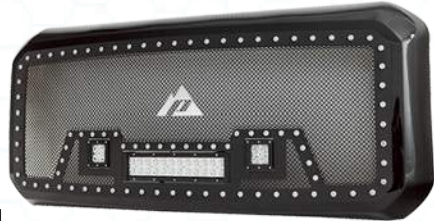

48-0825 11-16 Ford F-250/F-350



48-0843 14-15 Chevy Silverado 1500



48-0847 13-17 Dodge Ram 1500



48-0846 14-17 Toyota Tundra



48-0850 15 -17 Ford F-150



48-0825 11-16 Ford F-250/F-350



48-0843 14-15 Chevy Silverado 1500



48-0847 13-17 Dodge Ram 1500



48-0846 14-17 Toyota Tundra

Upper Grille	Bumper Grille	YEAR	MAKE	MODEL
48-0850	46-0777	15-17	Ford	F-150
48-0824	46-0744	09-14	Ford	F-150
48-0807		04-08	Ford	F-150
48-0825	46-0740	11-16	Ford	F-250/F-350
48-0803	46-0745	08-10	Ford	F-250/F-350
48-0804	46-0746	05-07	Ford	F-250/F-350
48-0805		99-04	Ford	F-250/F-350
48-0843	46-0758	14-15	Chevy	Silverado 1500
48-0844	46-0725	07-13	Chevy	Silverado 1500
48-0835	46-0741	11-14	Chevy	Silverado 2500/3500
48-0834		07-10	Chevy	Silverado 2500/3500
48-0847		13-17	Dodge	Ram 1500
48-0829		09-12	Dodge	Ram 1500
48-0812		06-08	Dodge	Ram 1500/2500/3500
48-0813		02-05	Dodge	Ram 1500/2500/3500
48-0848		13-17	Dodge	Ram 2500/3500
48-0828		10-12	Dodge	Ram 2500/3500
48-0846		14-17	Toyota	Tundra
48-0836		10-13	Toyota	Tundra
48-0817		07-09	Toyota	Tundra
48-0819	46-0754	05-11	Toyota	Tacoma
48-0849	46-0778	07-14	Toyota	FJ Cruiser
48-0832	46-0726	07-13	GMC	Sierra 1500
48-0842	46-0743	11-14	GMC	Sierra 2500/3500
48-0833		07-10	GMC	Sierra HD/2500/3500

Note: Bumper grilles are black Cut-out Evolution Mesh Grilles without LED light. (Refer to page 7)



Paramount Automotive Evolution LED Insert Grilles are constructed with the same precision as our packaged grilles, but allowing you to install a great looking insert grille with LED lights at a lower price point. Utilizing the factory shell these stainless steel inserts include high performance LED lights that not only add tremendous style but improved visibility.

FEATURES

- Chrome rivets provide a rugged off-road appearance. Fully formed woven mesh adds elegant look.
- Black textured powder coat finish on grille insert.
- Grille insert built from 100% 304 Stainless steel.
- Powerful LED lights come pre-installed.
- Wire harness and switch for LED lights are included.
- Cutout the factory grille insert for installation.
- 90 Days limited warranty on LED lights.



48-0971 15-17 Ford F-150



48-0901 11-16 Ford F-250/F-350



48-0971 15-17 Ford F-50



48-0966 13-17 Dodge Ram 2500/3500



48-0960 13-17 Dodge Ram 1500

48-0961 14-17 Toyota Tundra



48-0901 11-16 Ford F-250/F-350



48-0966 13-17 Dodge Ram 2500/3500



48-0960 13-17 Dodge Ram 1500



48-0961 14-17 Toyota Tundra



72W LED light Bar

12W Square LED light

Upper Grille	Bumper Grille	YEAR	MAKE	MODEL
48-0971	46-0777	15-17	Ford	F-150
48-0975		15-17	Ford	F-150(Bumper Grille)
48-0902	46-0744	09-14	Ford	F-150
48-0924		04-08	Ford	F-150
48-0967	46-0768	10-14	Ford	F-150 SVT Raptor
48-0901	46-0740	11-16	Ford	F-250/F-350
48-0903	46-0745	08-10	Ford	F-250/F-350
48-0904	46-0746	05-07	Ford	F-250/F-350
48-0905		99-04	Ford	F-250/F-350
48-0962	46-0725	07-13	Chevy	Silverado 1500
48-0930	46-0741	11-14	Chevy	Silverado 2500/3500
48-0908		07-10	Chevy	Silverado 2500/3500
48-0960		13-17	Dodge	Ram 1500
48-0917		09-12	Dodge	Ram 1500
48-0918		06-08	Dodge	Ram 1500/2500/3500
48-0919		02-05	Dodge	Ram 1500/2500/3500
48-0966		13-17	Dodge	Ram 2500/3500
48-0929		10-12	Dodge	Ram 2500/3500
48-0961		14-17	Toyota	Tundra
48-0920		10-13	Toyota	Tundra
48-0921		07-09	Toyota	Tundra
48-0970		12-15	Toyota	Tacoma
48-0922	46-0754	05-11	Toyota	Tacoma
48-0969	46-0778	07-14	Toyota	FJ Cruiser
48-0976		07-14	Toyota	FJ Cruiser(Bumper Grille)
48-0955		14-17	GMC	Sierra 1500
48-0912	46-0726	07-13	GMC	Sierra 1500
48-0968		15-17	GMC	Sierra 2500/3500
48-0934	46-0743	11-14	GMC	Sierra 2500/3500
48-0913		07-10	GMC	Sierra 2500/3500
48-0968		15-17	GMC	Yukon/Yukon XL
48-0974		14-16	GMC	Canyon

Note: Bumper grilles are black Cut-out Evolution Mesh Grilles without LED light. (Refer to page 7)

Evolution Packaged Grilles Black

Paramount Automotive Evolution Packaged Grilles are precision manufactured allowing owners to easily replace their factory grille with a gorgeous and functional upgrade. These riveted beauties come with OE style shell in a gloss black finish and form-fit stainless woven mesh centers featuring black textured powder coat. Simply remove the OE grille and replace it with the Paramount Automotive Evolution Packaged grille. You can even store your OE grille in the Paramount Automotive box for safe keeping.

FEATURES

- Chrome rivets provide a rugged off-road appearance.
- Custom-designed OE Style ABS shell in gloss black finish.
- Grille insert built from 100% 304 Stainless steel.
- Black textured powder coat finish on grille insert.
- Fully formed woven mesh adds elegant look.
- Easy installation – replaces OE grille assembly.



46-0248 15-17 Ford F-150



46-0225 11-16 Ford F-250/F-350



46-0237 13-17 Dodge Ram 1500



46-0244 14-15 Chevy Silverado 1500



46-0246 14-17 Toyota Tundra



46-0248 15-17 Ford F-150



46-0225 11-16 Ford F-250/F-350



46-0237 13-17 Dodge Ram 1500



46-0244 14-15 Chevy Silverado 1500



46-0246 14-17 Toyota Tundra

Upper Grille	Bumper Grille	YEAR	MAKE	MODEL
46-0248	46-0777	15-17	Ford	F-150
46-0224	46-0744	09-14	Ford	F-150
46-0207		04-08	Ford	F-150
46-0225	46-0740	11-16	Ford	F-250/F-350
46-0203	46-0745	08-10	Ford	F-250/F-350
46-0204	46-0746	05-07	Ford	F-250/F-350
46-0205		99-04	Ford	F-250/F-350
46-0244	46-0758	14-15	Chevy	Silverado 1500
46-0202	46-0725	07-13	Chevy	Silverado 1500
46-0235	46-0741	11-14	Chevy	Silverado 2500/3500
46-0234		07-10	Chevy	Silverado 2500/3500
46-0237		13-17	Dodge	Ram 1500
46-0229		09-12	Dodge	Ram 1500
46-0245		13-17	Dodge	Ram 2500/3500
46-0228		10-12	Dodge	Ram 2500/3500
46-0212		06-08	Dodge	Ram 1500/2500/3500
46-0213		02-05	Dodge	Ram 1500/2500/3500
46-0238		14-17	Toyota	Tundra
46-0236		10-13	Toyota	Tundra
46-0217		07-09	Toyota	Tundra
46-0221	46-0778	07-14	Toyota	FJ Cruiser
46-0232	46-0726	07-13	GMC	Sierra 1500
46-0242	46-0743	11-14	GMC	Sierra 2500/3500

Note: Bumper grilles are black Cut-out Evolution Mesh Grilles without LED light. (Refer to page 7)



46-0348 15-17 Ford F-150



46-0335 11-14 Chevy Silverado 2500/3500



46-0348 15-17 Ford F-150



46-0325 11-16 Ford F-250/F-350

46-0345 13-17 Dodge Ram 2500/3500



46-0344 14-15 Chevy Silverado 1500



46-0346 14-17 Toyota Tundra

46-0345 13-17 Dodge Ram 2500/3500



46-0346 14-17 Toyota Tundra



46-0342 11-14 GMC Sierra 2500/3500

Paramount Automotive Evolution Packaged Grilles are precision manufactured allowing owners to easily replace their factory grille with a gorgeous and functional upgrade. These riveted beauties come with OE style shell in a gloss black finish and form-fit stainless woven mesh centers featuring black textured powder coat. Simply remove the OE grille and replace it with the Paramount Automotive Evolution Packaged grille. You can even store your OE grille in the Paramount Automotive box for safe keeping.

FEATURES

- Chrome rivets provide a rugged off-road appearance.
- Custom-designed OE Style ABS shell in triple chrome finish.
- Grille insert built from 100% 304 Stainless steel.
- Black textured powder coat finish on grille insert.
- Fully formed woven mesh adds elegant look.
- Easy installation – replaces OE grille assembly.



Upper Grille	Bumper Grille	YEAR	MAKE	MODEL
46-0348	46-0777	15-17	Ford	F-150
46-0324	46-0744	09-14	Ford	F-150
46-0307		04-08	Ford	F-150
46-0325	46-0740	11-16	Ford	F-250/F-350
46-0303	46-0745	08-10	Ford	F-250/F-350
46-0304	46-0746	05-07	Ford	F-250/F-350
46-0305		99-04	Ford	F-250/F-350
46-0344	46-0758	14-15	Chevy	Silverado 1500
46-0302	46-0725	07-13	Chevy	Silverado 1500
46-0335	46-0741	11-14	Chevy	Silverado 2500/3500
46-0334		07-10	Chevy	Silverado 2500/3500
46-0337		13-17	Dodge	Ram 1500
46-0329		09-12	Dodge	Ram 1500
46-0345		13-17	Dodge	Ram 2500/3500
46-0328		10-12	Dodge	Ram 2500/3500
46-0312		06-08	Dodge	Ram 1500/2500/3500
46-0313		02-05	Dodge	Ram 1500/2500/3500
46-0338		14-17	Toyota	Tundra
46-0336		10-13	Toyota	Tundra
46-0317		07-09	Toyota	Tundra
46-0321	46-0778	07-14	Toyota	FJ Cruiser
46-0332	46-0726	07-13	GMC	Sierra 1500
46-0342	46-0743	11-14	GMC	Sierra 2500/3500

Note: Bumper grilles are black Cut-out Evolution Mesh Grilles without LED light. (Refer to page 7)

Black Mesh Packaged Grilles

Black Mesh Packaged Grilles from Paramount Automotive offer the same precision fit and easy installation as all of our Packaged Grilles. A direct OE replacement these tasteful gloss black mesh grilles deliver attitude and exceptional looks at an affordable price.

FEATURES

- Custom-designed OE Style ABS shell in gloss black finish.
- Grille insert built from 100% 304 Stainless steel.
- Black textured powder coat finish on grille insert.
- Fully formed woven mesh adds elegant look.
- Easy installation – replaces OE grille assembly.



44-0826 11-16 Ford F-250/F-350



44-0837 14-15 Chevrolet Silverado 1500



44-0835 13-17 Dodge Ram 1500



44-0836 14-17 Toyota Tundra



44-0834 11-14 GMC Sierra 2500/3500



44-0826 11-16 Ford F-250/F-350



44-0837 14-15 Chevrolet Silverado 1500



44-0835 13-17 Dodge Ram 1500



44-0836 14-17 Toyota Tundra



44-0834 11-14 GMC Sierra 2500/3500

PART#	YEAR	MAKE	MODEL
44-0824	09-14	Ford	F-150
44-0807	04-08	Ford	F-150
44-0826	11-16	Ford	F-250/F-350
44-0803	08-10	Ford	F-250/F-350
44-0804	05-07	Ford	F-250/F-350
44-0805	99-04	Ford	F-250/F-350
44-0806	07-14	Ford	Expedition
44-0808	05-09	Ford	Mustang
44-0837	14-15	Chery	Silverado 1500
44-0802	07-13	Chery	Silverado 1500
44-0832	11-14	Chery	Silverado 2500/3500
44-0831	07-10	Chery	Silverado 2500/3500
44-0801	07-14	Chery	Avalanche
44-0835	13-17	Dodge	Ram 1500
44-0828	09-12	Dodge	Ram 1500
44-0812	06-08	Dodge	Ram 1500/2500
44-0813	02-05	Dodge	Ram 1500/2500
44-0838	13-17	Dodge	Ram 2500/3500
44-0827	10-12	Dodge	Ram 2500/3500
44-0836	14-17	Toyota	Tundra
44-0833	10-13	Toyota	Tundra
44-0817	07-09	Toyota	Tundra
44-0818	02-06	Toyota	Tundra
44-0819	05-11	Toyota	Tacoma
44-0821	07-14	Toyota	FJ Cruiser
44-0829	07-13	GMC	Sierra 1500
44-0834	11-14	GMC	Sierra 2500/3500
44-0830	07-13	GMC	Sierra 2500/3500
44-0811	07-14	GMC	Yukon



Paramount Automotive Chrome Mesh Packaged Grilles offer the same precision fit and easy installation as all of our Packaged Grilles. A direct OE replacement these stylish polished chrome finished grilles create a refined, distinctive appearance for any truck.

FEATURES

- Custom-designed OE Style ABS shell in triple chrome finish.
- Grille insert built from 100% 304 Stainless steel.
- Triple chrome finish on grille insert.
- Fully formed woven mesh adds elegant look.
- Easy installation – replaces OE grille assembly.



42-0526 11-16 Ford F-250/F-350



42-0577 14-15 Chevy Silverado 1500



42-0578 13-17 Dodge Ram 2500/3500



42-0576 14-17 Toyota Tundra



42-0574 11-14 GMC Sierra 2500HD/3500HD

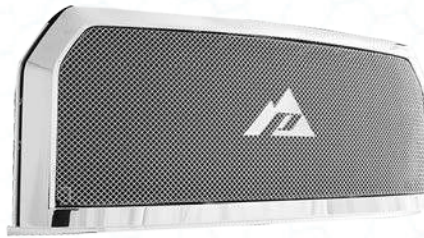

42-0579 15-17 Ford F-150

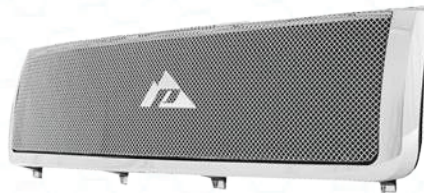

42-0572 11-14 Chevy Silverado 2500/3500



42-0575 13-17 Dodge Ram 1500



42-0576 14-17 Toyota Tundra



42-0569 07-13 GMC Sierra 1500



PART#	YEAR	MAKE	MODEL
42-0579	15-17	Ford	F-150
42-0524	09-14	Ford	F-150
42-0526	11-16	Ford	F-250/F-350
42-0503	08-10	Ford	F-250/F-350
42-0501	07-14	Chevy	Avalanche/Suburban/Tahoe
42-0577	14-15	Chevy	Silverado 1500
42-0502	07-13	Chevy	Silverado 1500
42-0572	11-14	Chevy	Silverado 2500/3500
42-0571	07-10	Chevy	Silverado 2500/3500
42-0575	13-17	Dodge	Ram 1500
42-0528	09-12	Dodge	Ram 1500
42-0578	13-17	Dodge	Ram 2500/3500
42-0527	10-12	Dodge	Ram 2500/3500
42-0521	07-14	Toyota	FJ Cruiser
42-0519	05-11	Toyota	Tacoma
42-0576	14-17	Toyota	Tundra
42-0573	10-13	Toyota	Tundra
42-0569	07-13	GMC	Sierra 1500/Denali
42-0574	11-14	GMC	Sierra 2500/3500
42-0570	07-10	GMC	Sierra 2500/3500
42-0511	07-14	GMC	Yukon/Yukon XL

Billet Packaged Grilles

Packaged Billet Grilles by Paramount Automotive give your ride that classic billet look in an easy to install OE replacement grille. These are available in timeless mirror chrome or gloss black powder coat finish. Let's face it, some trucks just look best dressed in billet.

FEATURES

- Custom-designed OE Style ABS shell in triple chrome finish or gloss black finish.
- Grille insert built from 100% 6061 aircraft Aluminum alloy.
- Polished or gloss black finish on grille insert.
- 4mm Aluminum extrusion.
- Easy installation – replaces OE grille assembly.



42-0805 11-16 Ford F-250/F-350



42-0829 14-15 Chevy Silverado 1500



42-0827B 13-17 Dodge Ram 1500



42-0828B 14-17 Toyota Tundra



42-0825 11-14 GMC Sierra 2500/3500



42-0805 11-16 Ford F-250/F-350



42-0829B 14-15 Chevy Silverado 1500



42-0827 13-17 Dodge Ram 1500



42-0828 14-17 Toyota Tundra



42-0825B 11-14 GMC Sierra 2500/3500

CHROME PART#	BLACK PART#	YEAR	MAKE	MODEL
42-0792	42-0792B	09-14	Ford	F-150
42-0327	42-0327B	04-08	Ford	F-150
42-0805	42-0805B	11-16	Ford	F-250/F-350
42-0311	42-0311B	08-10	Ford	F-250/F-350
42-0315	42-0315B	05-07	Ford	F-250/F-350
42-0319	42-0319B	99-04	Ford	F-250/F-350
42-0829	42-0829B	14-15	Chery	Silverado 1500
42-0303	42-0303B	07-13	Chery	Silverado 1500
42-0823	42-0823B	11-14	Chery	Silverado 2500/3500
42-0822	42-0822B	07-10	Chery	Silverado 2500/3500
42-0827	42-0827B	13-17	Dodge	Ram 1500
42-0815	42-0815B	09-12	Dodge	Ram 1500
42-0347	42-0347B	06-08	Dodge	Ram 1500/2500/3500
42-0351	42-0351B	02-05	Dodge	Ram 1500/2500/3500
42-0830	42-0830B	13-17	Dodge	Ram 2500/3500
42-0810	42-0810B	10-12	Dodge	Ram 2500/3500
42-0828	42-0828B	14-17	Toyota	Tundra
42-0824	42-0824B	10-13	Toyota	Tundra
42-0367	42-0367B	07-09	Toyota	Tundra
42-0375	42-0375B	05-11	Toyota	Tacoma
42-0205	42-0205B	01-04	Toyota	Tacoma
42-0213	42-0213B	07-14	Toyota	FJ Cruiser
42-0820	42-0820B	07-13	GMC	Sierra 1500
42-0825	42-0825B	11-14	GMC	Sierra 2500/3500
42-0821	42-0821B	07-10	GMC	Sierra 2500/3500

Note: Chrome and black colors for each model are all available.



At Paramount Automotive we construct our billet grilles using corrosion-resistant 6061-T6 aircraft grade aluminum to create 4mm and 8mm grilles with horizontal and vertical patterns. These grilles are hand-welded, with a polished black finish and impeccable fit.

FEATURES

- Grille insert built from 100% 6061 aircraft Aluminum alloy.
- Polished finish on grille insert.
- 4mm Aluminum extrusion.



38-0313 15-17 Ford F-150



36-0265 14-15 Chevy Silverado 1500



38-0292 11-16 Ford F-250/F-350



32-0209 13-17 Dodge Ram 1500



33-0181 14-15 GMC Sierra 1500

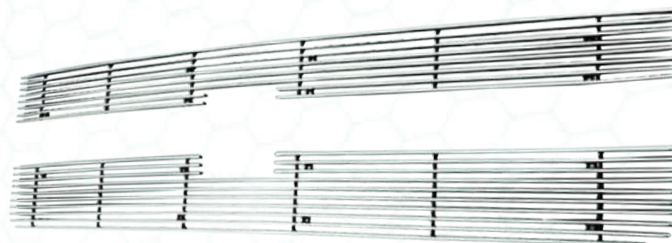

36-0264 15-17 Chevy Silverado 2500/3500



38-0313 15-17 Ford F-150

PART#	YEAR	MAKE	MODEL	INSTALLATION	PIECES
38-0292	11-16	Ford	F-250/F-350	Overlay	1PC
38-0310	15-17	Ford	F-150	Overlay	6PCS
38-0311	15-17	Ford	F-150	Cutout	1PC
38-0313	15-17	Ford	F-150	Replacement	1PC
38-0243	09-14	Ford	F-150	Overlay	1PC
36-0265	14-15	Chevy	Silverado 1500	Overlay	4PCS
36-0264	15-17	Chevy	Silverado 2500/3500	Overlay	4PCS
32-0209	13-17	Dodge	Ram 1500	Overlay	4PCS
32-0210	13-17	Dodge	Ram 2500/3500	Overlay	4PCS
31-0208	14-17	Toyota	Tundra	Cutout	1PC
31-0209	14-17	Toyota	Tundra	Overlay	1PC
31-0310	14-17	Toyota	Tundra	Overlay	1PC
33-0181	14-15	GMC	Sierra 1500	Overlay	7PCS
33-0183	14-15	GMC	Sierra 1500	Cutout	1PC
33-0184	15-17	GMC	Sierra 2500/3500	Cutout	1PC
33-0182	15-17	GMC	Yukon	Overlay	4PCS

Truck LED Winch Bumpers

Paramount Automotive LED Truck Winch Bumpers deliver form, function, and style. Designed to not only improve your trucks appearance, but also provide increased protection in urban and rural environments. Built-in LED lights add improved visibility and looks. Made with high strength steel plates, our bumpers will give you additional peace of mind knowing that they will withstand just about any hazard that comes along.

FEATURES

- Elegant design and powerful LED lights.
- Manufactured from durable 5/32" steel sheet.
- High strength D-Ring mounts are welded both inside and outside.
- Built-in Winch plate to accommodate up to a 15000lb winch.
- High quality textured powder coat for carrion protection and durability.
- Customer designed and plastic mold injection LED light housing for both style LED lights.
- Two 12W and two 15W LED lights are included.
- Wire harness and swith for LED lights are included.
- Two 4.75 Ton D-rings are included.
- Built-in 30" LED bar bracket at pre-runner hoop.
- 90 Days limited warranty on LED lights.



NOTE: 30" LED Light Bar for The Front Bumper Is not Included.



57-0502 14-15 GMC Sierra 1500



57-0115 11-16 Ford F-250/F-350

FRONT BUMPER	REAR BUMPER	YEAR	MAKE	MODEL
57-0112	57-0113	15-17	Ford	F-150
57-0110	57-0111	09-14	Ford	F-150
57-0114	57-0115	11-16	Ford	F-250/F-350
57-0302	57-0303	14-15	Chevy	Silverado 1500
57-0306	57-0307	07-13	Chevy	Silverado 1500
57-0304	57-0305	15-17	Chevy	Silverado 2500
57-0308	57-0309	11-14	Chevy	Silverado 2500
57-0204	57-0205	13-17	Dodge	Ram 1500
57-0202	57-0203	09-12	Dodge	Ram 1500
57-0206	57-0207	10-17	Dodge	Ram 2500
57-0404	57-0405	14-17	Toyota	Tundra
57-0406	57-0407	10-13	Toyota	Tundra
57-0502	57-0503	14-15	GMC	Sierra 1500
57-0508	57-0509	07-13	GMC	Sierra 1500
57-0504	57-0505	15-17	GMC	Sierra 2500
57-0506	57-0507	11-14	GMC	Sierra 2500



57-0112 15-17 Ford F-150



57-0404 14-17 Toyota Tundra



57-0206 10-17 Dodge Ram 2500



57-0115 11-16 Ford F-250/F-350



57-0308 11-14 Chevy Silverado 2500

NEW

Heavy Duty Truck Winch Bumpers



57-0122 15-17 Ford F-150



57-0123 15-17 Ford F-150



57-0124 09-14 Ford F-150



57-0410 14-17 Toyota Tundra



57-0411 14-17 Toyota Tundra

Heavy Duty Truck Winch Bumpers from Paramount Automotive bring added protection and handsomely rugged style for your truck. Manufactured from high strength steel plates, our Heavy Duty Winch Bumpers furnish truck owners with the kind of looks and protection necessary for anyone venturing where potential hazards may occur. Outdoorsmen and urban commuters alike will benefit from the style and function these bumpers provide.

FEATURES

- Heavy duty design and powerful LED lights.
- Manufactured from durable 5/32" steel sheet.
- High strength D-Ring mounts are welded both inside and outside.
- Built-in Winch plate to accommodate up to a 15000lb winch.
- High quality textured powder coat for corrosion protection and durability.
- Framed mesh vent covers hide mounting bracket while allowing critical airflow.
- Wire harness and switch for LED lights are included.
- 15W LED lights are included.
- Two 4.75 Ton D-rings are included.
- Built-in 30" LED bar bracket at pre-runner hoop.
- 90 Days limited warranty on LED lights.



NOTE: 30" LED Light Bar for the Front Bumper is not Included.



57-0510 14-17 GMC Sierra 1500



57-0411 14-17 Toyota Tundra

FRONT BUMPER	REAR BUMPER	YEAR	MAKE	MODEL
57-0122	57-0123	15-17	Ford	F-150
57-0124	57-0125	09-14	Ford	F-150
57-0130	57-0131	11-15	Ford	F-250/F-350/F-450
57-0510	57-0511	14-15	GMC	Sierra 1500
57-0512	57-0513	07-13	GMC	Sierra 1500
57-0410	57-0411	14-17	Toyota	Tundra
57-0412	57-0413	10-13	Toyota	Tundra
57-0310	57-0311	14-15	Chevy	Silverado1500
57-0312	57-0313	07-13	Chevy	Silverado1500
57-0314	57-0315	15-17	Chevy	Silverado 2500
57-0316	57-0317	11-14	Chevy	Silverado 2500
57-0208	57-0209	13-17	Dodge	Ram 1500
57-0210	57-0211	09-12	Dodge	Ram 1500
57-0212	57-0213	10-17	Dodge	Ram 2500

Truck Running Boards

Paramount Automotive Truck Running Boards come in a great variety of styles and applications to fit any cab size. Adding additional style to your truck while assisting entry on both stock and lifted vehicles. Steel brackets ensure a stable mounting.



YEAR	MAKE/MODEL	Evolution Board	Raptor Board	Oval Board	5" Safari	6" Safari	5" LED Board	6" LED Board	Regular Bracket	Heavy Duty Bracket
	Chevy/GMC									
99-15	Silverado/Sierra 1500 Extended Cab (including 01-14 HD)	52-0280	52-0380	52-0080	52-5580	52-6580	52-5680	52-6680	52-1010	52-1010HD
99-15	Silverado/Sierra HD Crew Cab (4DR), 04-15 1500 Crew Cab	52-0286	52-0386	52-0086	52-5586	52-6586	52-5686	52-6686	52-1010	52-1010HD
02-15	Avalanche	52-0286	52-0386	52-0086	52-5586	52-6586	52-5686	52-6686	52-1020	52-1020HD
05-15	Tahoe/Yukon	52-0280	52-0380	52-0080	52-5580	52-6580	52-5680	52-6680	52-1020	52-1020HD
05-15	Suburban/Yukon XL	52-0286	52-0386	52-0086	52-5586	52-6586	52-5686	52-6686	52-1020	52-1020HD
	Dodge									
02-08	Ram 1500 Quad Cab/03-09 Ram HD Quad Cab	52-0280	52-0380	52-0080	52-5580	52-6580	52-5680	52-6680	52-2010	52-2010HD
03-09	Ram 2500/3500 Quad Cab	52-0280	52-0380	52-0080	52-5580	52-6580	52-5680	52-6680	52-2010	52-2010HD
09-17	Ram 1500 Quad Cab	52-0280	52-0380	52-0080	52-5580	52-6580	52-5680	52-6680	52-2020	52-2020HD
10-15	Ram 2500/3500 Crew Cab	52-0286	52-0386	52-0086	52-5586	52-6586	52-5686	52-6686	52-2020	52-2020HD
16-17	Ram 2500/3500 Quad Cab	52-0280	52-0380	52-0080	52-5580	52-6580	52-5680	52-6680	52-2050	52-2050HD
	Ford									
99-16	Super Duty Super Cab - 4 DR	52-0280	52-0380	52-0080	52-5580	52-6580	52-5680	52-6680	52-3010	52-3010HD
99-16	Super Duty Super Crew - 4 DR / Excursion	52-0286	52-0386	52-0086	52-5586	52-6586	52-5686	52-6686	52-3010	52-3010HD
97-03	F-150/F-250 LT Super Cab	52-0280	52-0380	52-0080	52-5580	52-6580	52-5680	52-6680	52-3030	52-3030HD
01-14	F-150 Super Crew	52-0286	52-0386	52-0086	52-5586	52-6586	52-5686	52-6686	52-3030	52-3030HD
04-14	F-150 Super Cab	52-0280	52-0380	52-0080	52-5580	52-6580	52-5680	52-6680	52-3020	52-3020HD
15-17	F-150 Super Cab	52-0280	52-0380	52-0080	52-5580	52-6580	52-5680	52-6680	52-3050	52-3050HD
15-17	F-150 Super Crew	52-0286	52-0386	52-0086	52-5586	52-6586	52-5686	52-6686	52-3050	52-3050HD
	Toyota									
07-17	Tundra Double Cab	52-0280	52-0380	52-0080	52-5580	52-6580	52-5680	52-6680	52-4010	52-4010HD
07-17	Tundra CrewMax	52-0286	52-0386	52-0086	52-5586	52-6586	52-5686	52-6686	52-4010	52-4010HD
05-15	Tacoma Access Cab (4DR)	52-0280	52-0380	52-0080	52-5580	52-6580	52-5680	52-6680	52-4020	52-4020HD
05-15	Tacoma Double Cab (4DR)	52-0286	52-0386	52-0086	52-5586	52-6586	52-5686	52-6686	52-4020	52-4020HD
	Nissan									
04-09	Titan King Cab	52-0270	52-0370	52-0070					52-6010	52-6010HD
05-09	Frontier King Crew Cab/Pathfinder(4 Door)	52-0280	52-0380	52-0080	52-5580	52-6580	52-5680	52-6680	52-6020	52-6020HD



FEATURES

Running Boards

- More styles to choose to make your vehicle unique.
- Add style and function to your truck.
- Protect vehicles from on and off-road debris.
- Aid in vehicle entry.
- High quality textured powder coat for corrosion protection and durability.
- Optional heavy duty brackets or regular brackets are sold separately.

Evolution Running Boards

- Perforated stainless steel pads offer maximum grip and style.
- Stainless steel woven mesh adds elegant look.

Oval Running Boards

- Made from cold rolled steel sheet .
- Durable non-slip pads and end caps.

Raptor Running Boards

- Raptor style design.
- Louvered flow through design and channeled framing for maximum strength.

LED Web Running Boards

- Elegant design incorporated with one LED light on both front and rear ends.
- Contemporary web design with brushed 304 stainless steel pads.

Safari Running Boards

- Made from cold rolled steel sheet .
- Contemporary Safari design brushed 304 stainless steel pads.
- Durable sheet metal end caps.



Raptor Running Board



Oval Running Board



LED Web Running Board



Evolution Running Board



04-14 F-150 Super Cab Heavy Duty/Regular Bracket



Safari Running Board

Truck Aluminum Running Boards



Truck Aluminum Running Boards from Paramount Automotive provide an eye-catching appearance with a refined fit. These custom fit running boards have a clean, unpretentious design that puts bulky overdone nerf bars to shame. The lightweight yet sturdy aluminum frame easily supports up to 300 lbs. without bending. Available in 4", 5" and 6" width.



Clear Coat Series 1 Running Boards

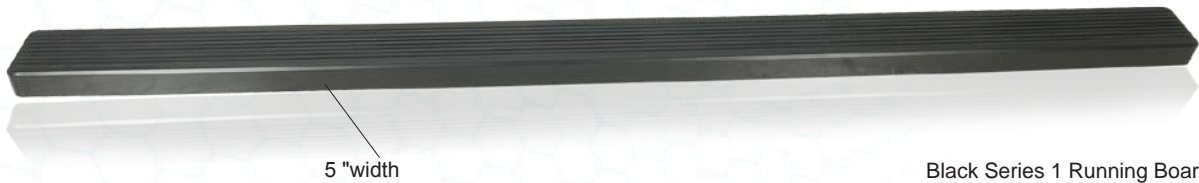

Black Series 1 Running Boards



Clear Coat Series 2 Running Boards



Black Series 2 Running Boards

YEAR	MAKE/MODEL	SERIES 1			SERIES 2			REGULAR BRACKET	HEAVY DUTY BRACKET
		4 Inch	5 Inch	6 Inch	4 Inch	5 Inch	6 Inch		
	Chevy/GMC								
99-15	Silverado/Sierra 1500 Extended Cab (including 01-14 HD)	52-1480	52-1580	52-1680	52-2480	52-2580	52-2680	52-1010	52-1010HD
99-15	Silverado/Sierra HD Crew Cab (4DR), 04-15 1500 Crew Cab	52-1486	52-1586	52-1686	52-2486	52-2586	52-2686	52-1010	52-1010HD
02-15	Avalanche	52-1486	52-1586	52-1686	52-2486	52-2586	52-2686	52-1020	52-1020HD
05-15	Tahoe/Yukon	52-1480	52-1580	52-1680	52-2480	52-2580	52-2680	52-1020	52-1020HD
05-15	Suburban/Yukon XL	52-1486	52-1586	52-1686	52-2486	52-2586	52-2686	52-1020	52-1020HD
	Dodge								
02-08	Ram 1500 Quad Cab/03-09 Ram HD Quad Cab	52-1480	52-1580	52-1680	52-2480	52-2580	52-2680	52-2010	52-2010HD
03-09	Ram 2500/3500 Quad Cab	52-1480	52-1580	52-1680	52-2480	52-2580	52-2680	52-2010	52-2010HD
09-17	Ram 1500 Quad Cab	52-1480	52-1580	52-1680	52-2480	52-2580	52-2680	52-2020	52-2020HD
10-15	Ram 2500/3500 Crew Cab	52-1486	52-1586	52-1686	52-2486	52-2586	52-2686	52-2020	52-2020HD
16-17	Ram 2500/3500 Quad Cab	52-1480	52-1580	52-1680	52-2480	52-2580	52-2680	52-2050	52-2050HD
	Ford								
99-16	Super Duty Super Cab - 4 DR	52-1480	52-1580	52-1680	52-2480	52-2580	52-2680	52-3010	52-3010HD
99-16	Super Duty Super Crew - 4 DR / Excursion	52-1486	52-1586	52-1686	52-2486	52-2586	52-2686	52-3010	52-3010HD
97-03	F-150/F-250 LT Super Cab	52-1480	52-1580	52-1680	52-2480	52-2580	52-2680	52-3030	52-3030HD
01-14	F-150 Super Crew	52-1486	52-1586	52-1686	52-2486	52-2586	52-2686	52-3030	52-3030HD
04-14	F-150 Super Cab	52-1480	52-1580	52-1680	52-2480	52-2580	52-2680	52-3020	52-3020HD
15-17	F-150 Super Cab	52-1480	52-1580	52-1680	52-2480	52-2580	52-2680	52-3050	52-3050HD
15-17	F-150 Super Crew	52-1486	52-1586	52-1686	52-2486	52-2586	52-2686	52-3050	52-3050HD
	Toyota								
07-17	Tundra Double Cab	52-1480	52-1580	52-1680	52-2480	52-2580	52-2680	52-4010	52-4010HD
07-17	Tundra CrewMax	52-1486	52-1586	52-1686	52-2486	52-2586	52-2686	52-4010	52-4010HD
05-15	Tacoma Access Cab (4DR)	52-1480	52-1580	52-1680	52-2480	52-2580	52-2680	52-4020	52-4020HD
05-15	Tacoma Double Cab (4DR)	52-1486	52-1586	52-1686	52-2486	52-2586	52-2686	52-4020	52-4020HD
	Nissan								
05-09	Frontier King Crew cab/Pathfinder(4 Door)	52-1480	52-1580	52-1680	52-2480	52-2580	52-2680	52-6020	52-6020HD

Note: Part numbers on this form are clear coat boards'. You should add letter "B" to the end of part numbers to order the same black style.



FEATURES

Series 1 Running Boards

- Covered with full-length high quality UV resistant non-slip rubber pad to prevent debonding and delamination.
- Made from aircraft Aluminum alloy 6061-T6 extrusion for high strength and integrity.
- Optional 4", 5" and 6" width to fit customer's need.
- Brushed finished with clear coat or matte black powder coat depending on customer's choice.
- Optional Heavy duty or regular mounting brackets and hardware sold seperatly for customer to choose.
- Easy bolt-on installation.

Series 2 Running Boards

- Contemporary design with durable UV resistant non-slip pads and end caps.
- Made from aircraft Aluminum alloy 6061-T6 extrusion for high strength and integrity.
- Optional 4", 5" and 6" width to fit customer's need.
- Brushed finished with clear coat or matte black powder coat depending on customer's choice.
- Optional Heavy duty or regular mounting brackets and hardware sold seperatly for customer to choose.
- Easy bolt-on installation.



52-1686 Clear Coat Series 1 Running Boards

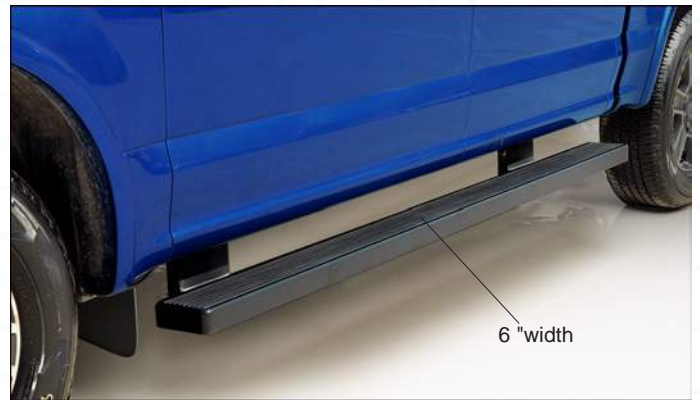

52-1686B Black Series 1 Running Boards



52-2686 Clear Coat Series 2 Running Boards

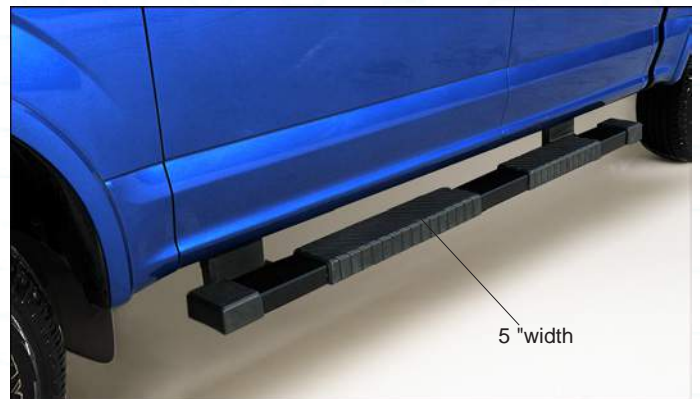

52-2580B Black Series 2 Running Boards



52-3020 04-14 F-150 Super Cab Regular Bracket



52-3020HD 04-14 F-150 Super Cab Heavy Duty Bracket

Truck LED Bull Bars

Paramount Automotive LED Bull Bars offer a unique take on the bull bar unlike any other. Finished in durable black textured powder coat, these bull bars come with dual 30" high powered LED light bars, providing on and off road protection for your vehicle plus vastly improved nighttime visibility. Bolt these directly to your factory bumper for a complete OE fit and finish.

FEATURES

- Innovative re-design of traditional bull bar incorporated with two powerful 180W LED bars.
- Heavy duty rubber pads for extra off-road protection.
- High quality textured powder coat for corrosion protection and durability.
- Easy bolt-on installation .
- 90 Days limited warranty on LED lights.



54-3108 09-17 Ford F-150



54-2101 13-17 Dodge Ram 1500



54-1102 07-13 Chevy Silverado 1500

PART#	YEAR	MAKE	MODEL
54-1101	14-15	Chevy	Silverado 1500
54-1107	14-15	GMC	Sierra 1500
54-1102	07-13	Chevy/GMC	Silverado/Sierra 1500
54-1104	15-17	Chevy/GMC	Silverado/Sierra 2500/3500
54-1105	11-14	GMC	Sierra 2500/3500
54-2101	13-17	Dodge	Ram 1500
54-2104	10-17	Dodge	Ram 2500/3500
54-3108	09-17	Ford	F-150
54-3103	11-16	Ford	F-250/F-350
54-5401	14-17	Toyota	Tundra



54-3108 09-17 Ford F-150



54-3103 11-16 Ford F-250/F-350



54-1102 07-13 Chevy Silverado 1500



54-2104 10-17 Dodge Ram,2500/3500



54-1107 14-15 GMC Sierra 1500



Paramount Traildriver Truck Flares feature rivet-style designs in package that is unmatched for style and durability. From the street to the trails Traildriver flares protect your truck against every road condition.

Our proprietary Proguard® ABS construction provides a durable elegant OEM finish with maximum protection against the elements. No-Drill design on most applications makes installation quick and easy.

Made with pride in the USA.



FEATURES

- Bolt-on look without the need to drill your vehicle.
- Provides a minimum 2 inches of wheel coverage.
- No-drill installation on most applications using existing factory mounting holes.
- Heavy-Duty impact resistant Proguard® construction for superior UV protection .
- Comes standard in OEM satin black textured finish.
- Can be painted to match your vehicle if you choose.
- Easy to install- requires basic tools.
- Includes all installation mounting hardware and instructions.



58-0702 14-17 Toyota Tundra (Short, Standard and Long Bed)



58-0603 10-17 Dodge Ram 2500 (Standard and Long Bed)



58-0505 14-15 Chevy Silverado 1500/2500/3500 (5.9 Ft Bed)



58-0403 11-16 Ford Super Duty F250 (Standard and Long Bed)

PART#	YEAR	MODEL
58-0403	11-16	Ford Super Duty F250 (Standard and Long Bed)
58-0402	08-10	Ford Super Duty F250 (Standard and Long Bed)
58-0401	99-07	Ford Super Duty F250 (Standard and Long Bed)
58-0406	15-17	Ford F-150 (short, Standard and Long Bed)
58-0405	09-14	Ford F-150 (short, Standard and Long Bed)
58-0404	04-08	Ford F-150 (Short, Standard and Long Bed)
58-0504	14-17	Chevy Silverado 1500/2500/3500 (6.6 Ft /8.0 Ft Bed)
58-0505	14-15	Chevy Silverado 1500/2500/3500 (5.9 Ft Bed)
58-0502	07-13	Chevy Silverado 1500/2500/3500 (6.6 Ft /8.0 Ft Bed)
58-0503	07-13	Chevy Silverado 1500 (5.9 Ft Bed)
58-0501	99-06	Chevy Silverado 1500/2500/3500 (6.6 Ft /8.0 Ft Bed)
58-0603	10-17	Dodge Ram 2500 (Standard and Long Bed)
58-0602	09-17	Dodge Ram 1500 (Short, Standard and Long Bed)
58-0601	02-08	Dodge Ram 1500 (Standard and Long Bed)
58-0601	03-09	Dodge Ram 2500 (Standard and Long Bed)
58-0702	14-17	Toyota Tundra (Short, Standard and Long Bed)



58-0702 14-17 Toyota Tundra (Short, Standard and Long Bed)

Traildriver JK Fender Flares

Add an aggressive off-road appearance to your Jeep JK with Paramount Traildriver flares.

Made from high impact thermoformed materials Our flares combine maximum durability and flexibility with rugged good looks. Choose the design that best suits your driving needs. The Flat-style flares have a narrow profile for rugged off-road driving or the wider rivet-flares which offer additional tire coverage and protection. Both styles are made with pride in the USA and will provide years of trouble free service.

58-0304 07-17 Jeep Wrangler JK [Rivet—Pocket Style Fender Flares 4pc Set]

FEATURES

- Larger wider extreme surface provides 2 1/2 inches of additional tire coverage.
- .200 super wall thickness for maximum durability and flexibility during harshest weather.
- Virtually unbreakable PE construction will stand up to the harshest off-road conditions.
- Unique design allows use of factory splash liner.
- Comes in satin black pebble finish.
- No drilling or cutting your Jeep. Installs in existing factory holes.
- Easy installation using basic tools.
- Design incorporates factory side marker lights.
- Includes installation mounting hardware and instructions.



58-0305 07-17 Jeep Wrangler JK [Flat-Style Fender Flares 4pc Set]

FEATURES

- Heavy-Duty impact resistant Proguard © construction for superior UV protection.
- OEM textured satin finish, can be painted to match your vehicle.
- No drilling or cutting required for installation – mounts to existing factory holes.
- Come complete with LED side marker light.
- Provides additional clearance for large tires.
- Easy installation using basic tools.
- Includes all necessary mounting hardware and instructions.





Paramount Automotive steel flares provide additional protection, durability, and increased clearance, yet their rugged design and precise fitment make for an easy installation.

FEATURES

- Manufactured from durable 1/8" cold rolled steel sheet.
- Protects vehicles from on & off-road debris.
- Tire coverage ranges from 5" to 8.5" inches.
- High quality textured powder coat for corrosion protection and durability.
- Easy bolt-on installation.

PART#	YEAR	APPLICATION
51-0379	07-17	JK 2/4 Door Evolution Front Fender Flare
51-0380	07-17	JK 4 Door Evolution Rear Fender Flare
51-0312	07-17	JK 2/4 Door Stubby Front Fender
51-0313	07-17	JK 2/4 Door Stubby Rear Fender
51-0343	07-17	JK 2/4 Door Armor Front Fender
51-0344	07-17	JK 2/4 Door Armor Rear Fender
51-0356	07-17	JK 2/4 Door Sharp Stubby Fender



51-0379/51-0380



51-0379/51-0380



51-0312/51-0313



51-0312/51-0313



51-0343/51-0344



51-0343/51-0344



51-0356



51-0356



Paramount Automotive JK Tubular Doors are excellent accessories for off-road adventure. These doors offer easy installation, mounting directly into OE hinges, and featuring an excellent factory style door latch assembly that can be adjusted to prevent vibrations and ensure proper function. Paramount Tubular Doors significantly increase visibility and access to enhance your overall off-road experience. Finished with a textured black powder coating, these doors look great and are ready for action.

PART#	YEAR	MAKE	APPLICATION
51-0382	07-17	Jeep	JK (4 Door) Matrix Tubular Doors
51-0384	07-17	Jeep	JK (2 Door) Matrix Tubular Doors
51-0631	07-17	Jeep	JK (4 Door) Tubular Doors with Pocket
51-0657	07-17	Jeep	JK (2 Door) Tubular Doors with Pocket

Note: Military grade sideview mirror 51-0511 or military grade sideview mirror 51-0490 on A-pillar are sold separately.

MULTI-POCKET TUBULAR DOORS

- 1680 Denier nylon fabric is durable weather resistant, water-proof, and easy to keep cleaning for excellent tear strength and high abrasion resistance.
- Multiple pockets inside and outside for storage.
- High quality belts and hooks keep storage safe.

FEATURES

- Manufactured from durable 1 1/4" steel tube and 1/8" cold rolled steel sheet.
- Built-in OE quality latch assembly.
- Mounts to OE door hinge.
- Available for both 2 door and 4 door JK.
- Pre-drilled for military grade mirror 51-0511 (sold separately).
- High quality textured powder coat for corrosion protection and durability.



51-0631(Multi-Pocket Tubular Doors without Mirrors)+51-0511(Sideview Mirrors)

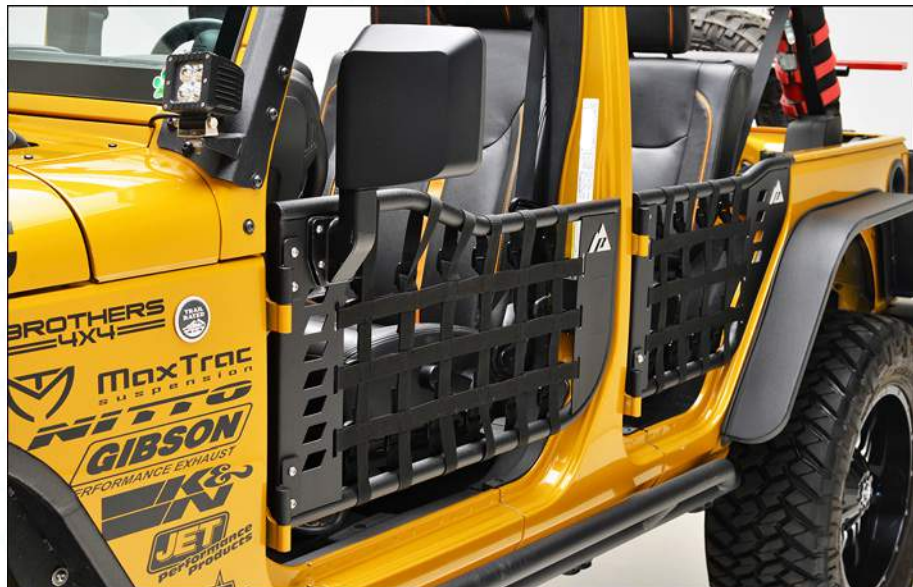

51-0382(Matrix Tubular Doors without Mirrors)+51-0511(Sideview Mirrors)

MATRIX TUBULAR DOORS

- 1680 Denier nylon fabric is durable weather resistant, water-proof, and easy to keep cleaning for excellent tear strength and high abrasion resistance.
- Matrix design gives our tubular doors a simple and clean look.

PART#	APPLICATION
51-0490	A-Pillar Sideview Mirror

Paramount Automotive Sideview Mirrors for Tubular Doors are professional grade for maximum off-road visibility. Our JK tubular doors come pre-drilled for mirror attachment, and we offer optional brackets to install the mirrors directly to the A-pillar.



51-0490 Mirror with Brackets to Install on Pillar (pair)



Paramount Automotive JK Tubular Doors are excellent accessories for off-road adventure. These doors offer easy installation, mounting directly into OE hinges, and featuring an excellent factory style door latch assembly that can be adjusted to prevent vibrations and ensure proper function. Paramount Tubular Doors significantly increase visibility and access to enhance your overall off-road experience. Finished with a textured black powder coating, these doors look great and are ready for action.

PART#	YEAR	MAKE	APPLICATION
51-0376	07-17	Jeep	JK (4 Door) Tubular Safari Doors
51-0386	07-17	Jeep	JK (2 Door) Tubular Safari Doors
51-0632	07-17	Jeep	JK (4 Door) Tubular Web Doors
51-0656	07-17	Jeep	JK (2 Door) Tubular Web Doors

Note: Military Quality Reflection Mirror 51-0511 or Military Quality Reflection Mirror 51-0490 on A-pillar are sold separately



51-0632(Tubular Web Door without Mirrors)+51-0511(Sideview Mirrors)



51-0376(Tubular Safari Doors without Mirrors)+51-0511(Sideview Mirrors)



51-0511 Mirror Installed on Door (pair)



WEB TUBULAR DOORS



- Contemporary web design.
- Increase visibility and easy access.

FEATURES

- Manufactured from durable 1 1/4" steel tube and 1/8" cold rolled steel sheet.
- Built-in OE quality latch assembly.
- Mounts to OE door hinge.
- Available for both 2 door and 4 door JK.
- Pre-drilled for military grade mirror 51-0511 (sold separately).
- High quality textured powder coat for corrosion protection and durability.

SAFARI TUBULAR DOORS

- Contemporary Safari design for off-road.
- Increase visibility and easy access.

PART#	APPLICATION
51-0511	Sideview Mirror

Paramount Automotive Sideview Mirrors for Tubular Doors are professional grade for maximum off-road visibility. Our JK tubular doors come pre-drilled for mirror attachment, and we offer optional brackets to install the mirrors directly to the A-pillar.



Add some style and functionality before embarking on your next off-road adventure. Paramount Automotive's JK Side Steps give you increased body protection and assist in getting in and out of your JK. A variety of options allows you to select your style.

FEATURES

- Manufactured from durable 2"X0.120 steel tube and 13/16" steel sheet.
- Protects vehicles from on & off-road debris.
- Available for both 2 door and 4 door models.
- Easy bolt-on installation.

PART#	YEAR	MAKE	APPLICATION
52-0054	07-17	Jeep	JK (2 Door) 54" Oval Running Board
51-0499	07-17	Jeep	JK (4 Door) 3" Curved Round Side Steps
51-0639	07-17	Jeep	JK (4 Door) Spider Web Running Board
51-0640	07-17	Jeep	JK (4 Door) HD Spider Web Running Board
51-0643	07-17	Jeep	JK (4 Door) Tubular Side Steps



52-0054 JK (2 Door) 54" Oval Running Board



51-0499 JK (4 Door) 3" Curved Round Side Steps



51-0639 JK (4 Door) Web Running Board



51-0640 JK (4 Door) HD Spider Web Running Board



51-0643 JK (4 Door) Tubular Side Steps



OE running boards offer only limited protection that is quickly overcome by spirited offroad driving. Paramount Automotive Rock Sliders offer a durable solution that can handle such different environments. A variety of styles allow you to select the right look for your ride. Whether you are bouncing off a boulder or glancing off a tree, you'll have the peace of mind knowing your Jeep will return in the same condition as when you left.

FEATURES

- Manufactured from durable 2"X0.120 steel tube and 13/16" steel sheet.
- Protects vehicles over rocks.
- Available for both 2 doors and 4 doors.
- Easy bolt-on installation.

PART#	YEAR	MAKE	APPLICATION
51-0311	07-17	Jeep	JK (4 Door) Rocker Guard
51-0323	07-17	Jeep	JK (4 Door) -Tube Rocker Slider
51-0349	07-17	Jeep	JK (2 Door) -Tube Rocker Slider
51-0345	07-17	Jeep	JK (4 Door) -Raptor Rocker Slider
51-0346	07-17	Jeep	JK (2 Door) -Raptor Rocker Slider



51-0311 JK (4 Door) Rocker Guard



51-0323 JK (4 Door) Tube Rock Slider



51-0349 JK (2 Door) Tube Rock Slider



51-0345 JK (4 Door) Raptor Rock Slider



51-0346 JK (2 Door) Raptor Rock Slider

JK All Weather Floor Liners

Traildriver All-Weather Floor Liners and Cargo Liners are custom engineered for an exact fit to the shape and contour of your vehicles floor. Generous 2 inch high wall keeps any spilled liquids contained and away from the carpet. Mud, snow, ice, sodas even battery acid won't hurt these tough durable liners. Easy to remove and clean, simply hose them off and reinstall. The raised edge around the hook attachment helps to prevent dirt and moisture from getting through this area and onto the carpet.



FEATURES

- 2" high sidewalls trap spills and keeps your factory carpets fresh and clean.
- Cross hatch pattern provides traction to help remove mud, snow etc from shoes and boots.
- TPO (Thermo Polyolefin) construction provides ultimate long lasting durability.
- Factory hook attachment ensures the floor liners stay in place long after installation.
- Designed engineered and built in the USA.

PART#	YEAR	MAKE	APPLICATION
59-0111	07-13	Jeep	JK 2PC 2 Door/4 Door Front
59-0112	07-17	Jeep	JK 2PC 2Door Rear
59-0113	07-17	Jeep	JK 1PC 4Door Rear
59-1124	07-13	Jeep	JK 4PC 2 Door Front/Rear
59-1125	07-13	Jeep	JK 3PC 4 Door Front/Rear
59-0211	07-17	Jeep	JK 1PC 2Door/4Door Rear Cargo



59-1124



59-1125

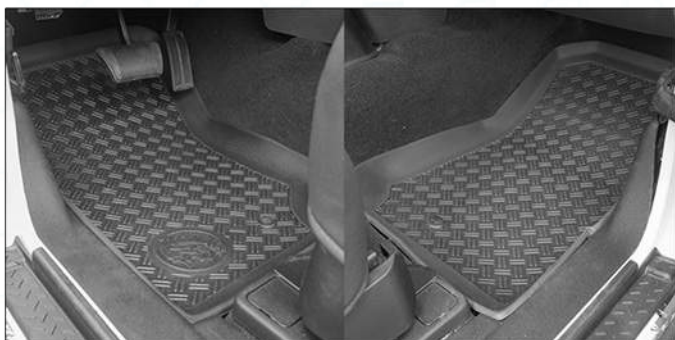

59-0111



59-0112



59-0113



59-0211

NEW

JK Grille Guard/Bull Bar



Paramount Automotive JK Grille Guard/Bull Bar allows you to select the front end features that work best for you. If you are more concerned with protecting the front end from on and off-road hazards go for the grille guard. If lighting up that dark night is more important, go with the LED Bull Bar featuring dual 30" LED lights. Either one is a brilliant solution.

PART#	YEAR	MAKE	APPLICATION
51-0497	07-17	Jeep	JK Grille Guard
51-0498	07-17	Jeep	JK Double 30" LED Bull Bar



51-0497

FEATURES

- Manufactured from durable 1 1/2"X0.120 steel tube and 3/16" steel sheet.
- Provide off-road protection.
- High quality textured powder coat for corrosion protection and durability.
- Easy bolt-on installation.



51-0498

FEATURES

- Innovative re-design of traditional bull bar incorporated with two powerful 180W LED bars.
- Heavy duty rubber pads for extra off-road protection.
- High quality textured powder coat for corrosion protection and durability.
- Easy bolt-on installation.
- 90 Days limited warranty on LED lights.



JK "Tailgater" Rear Bumper



The New E-Z GLIDE® Rear Bumper represent the latest generation in rear bumper design from Paramount Automotive. These bumpers allow you to access the rear storage area by opening the tire carrier and tailgate at the same time, giving you features that come in handy at the mall, with the strength and durability to endure off-road.

FEATURES

- Heavy duty and high quality engineering swing away tire carrier system.
- High quality bearings used at shaft of tire carrier for smoothest open and close.
- Manufactured from durable 5/32" steel sheet.
- High strength D-ring mounts are welded both inside and outside.
- Adjustable OE style third brake light bracket fit up to 37" tire.
- Third brake light mount with plug extension included in the rear tire carrier.
- High quality textured powder coat for corrosion protection and durability.
- D-rings included – 4.75 ton capacity each.
- 2" standard hitch receiver included.
- Easy bolt-on installation.

PART#	YEAR	MAKE	APPLICATION
51-0395	07-17	Jeep	JK Tailgate Rear Bumper





Paramount's Heavy Duty Hinged Tire Carrier provides an easy and elegant solution for mounting your oversize spare tire. Choose from our cast steel or cold rolled steel models. Both tire carriers employ the same unique design which utilizes the factory hinge mounting positions as well as tying into the tire carrier mounting points. This results in additional support and allows for mounting up to a 37" tire.

HEAVYDUTY HINGED TIRE CARRIER

- Easy single action of opening and closing of the tailgate.
- Made of 5/32" cold rolled steel.
- Adjustable tire mount up to 37" maximum tire size.
- Load carrying capacity of 135 lbs.
- Protective EPDM gaskets included to protect factory finish.
- CNC machined hinge/pivot structure.
- Third brake light mount included.
- Easy bolt-on installation

PART#	YEAR	MAKE	APPLICATION
51-0398	07-17	Jeep	JK Deluxe Cast Steel Hinged Tire Carrier
51-0399	07-17	Jeep	JK Heavyduty Hinged Tire Carrier



51-0399



51-0399

DELUXE CAST STEEL HINGED TIRE CARRIER

- Easy single action of opening and closing of the tailgate
- Made of cast steel
- Adjustable tire mount up to 37" maximum tire size
- Load carrying capacity of 135 lbs
- Protective EPDM gaskets included to protect factory finish
- CNC machined hinge/pivot structure
- Third brake light mount included
- Easy bolt-on installation



51-0398



51-0398

JK Web Series Bumpers



Paramount Automotive's web series product include front bumpers, rear bumpers, side steps, and tubular doors. Make your JK standing out no matter where you are.

PART#	YEAR	MAKE	APPLICATION
51-0653	07-17	Jeep	JK Web Front Bumper
51-0642	07-17	Jeep	JK Web Rear Bumper

LED Light not include



FEATURES

- Contemporary web design fits for off-road and on the street.
- Brushed 304 stainless steel web resist rust.
- Manufactured from durable 5/32" steel sheet.
- High strength D-Ring mounts are welded inside and out.
- Built-in Winch plate supports up to a 12000 lbs winch.
- D-rings included – 4.75 ton capacity each.
- 2" standard hitch receiver included for rear bumper.
- High quality textured powder coat for corrosion protection and durability.
- Easy bolt-on installation.



51-0653



51-0642

NEW

JK LED Modular Front Bumper



Paramount Automotive JK Modular Bumpers allow you to build your perfect bumper. The Optional components offer you design choice to customize a bumper that's right for you.

FEATURES

- Contemporary web design fits for off-road and on the street.
- Brushed 304 stainless steel web never rust.
- Removable pre-runner hoop and end caps.
- Powerful two 12W LED lights included.
- Wire harness and swith for LED lights are included.
- Custom designed and plastic mold injection LED light housing.
- Manufactured from durable 5/32" steel sheet.
- High strength D-Ring mounts are welded inside and out.
- Built-in winch plate supports up to a 12000 lbs winch.
- D-rings included – 4.75 ton capacity each.
- High quality textured powder coat for corrosion protection and durability.
- Easy bolt-on installation.

PART#	YEAR	MAKE	APPLICATION
51-0650	07-17	Jeep	JK Web Modular Front Bumper

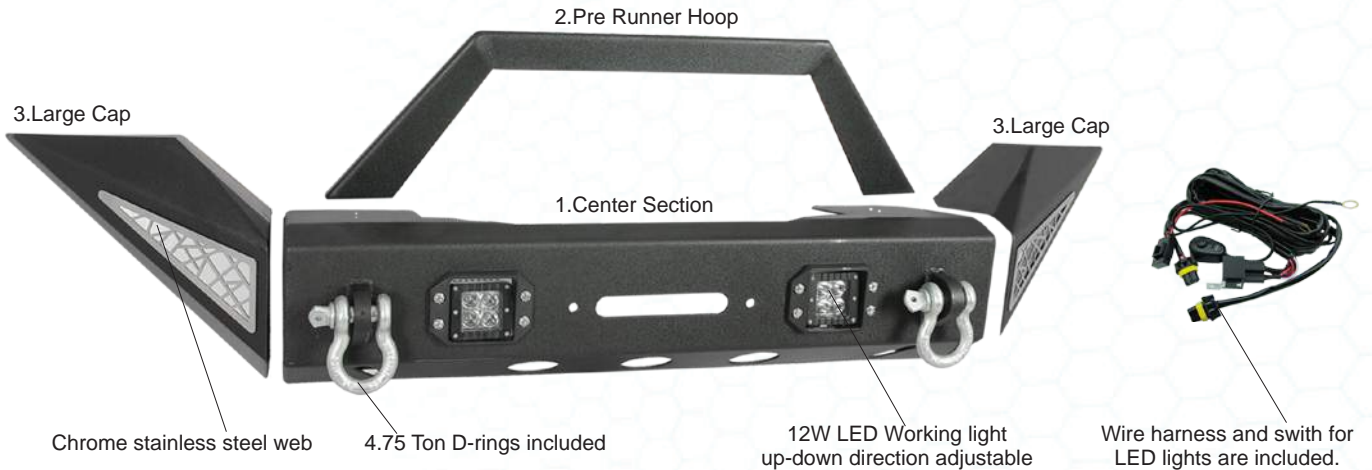

Option 1



Option 2



Option 3



Option 4

JK Stinger Bumpers

Paramount Automotive JK Stinger Bumpers are built for the hardcore off-road enthusiasts. These heavy duty stinger designs enable you to safely maneuver through any challenging terrain.

FEATURES

- Manufactured from durable 5/32" steel sheet and steel tube.
- High strength D-Ring mounts are welded both inside and outside.
- Built-in winch plate supports up to a 12000 lbs winch.
- D-rings included – 4.75 ton capacity each.
- High quality textured powder coat for corrosion protection and durability.
- Easy bolt-on installation.

PART #	YEAR	APPLICATION
51-0304	07-17	JK Rock Crawler Tubular Front Bumper
51-0366	07-17	JK Stinger with OE Fog Light Housing
51-0374	07-17	JK R10 Front Bumper
51-0389	07-17	JK Stubby Front Bumper with Grille Guard



51-0304



51-0304



51-0374



51-0374

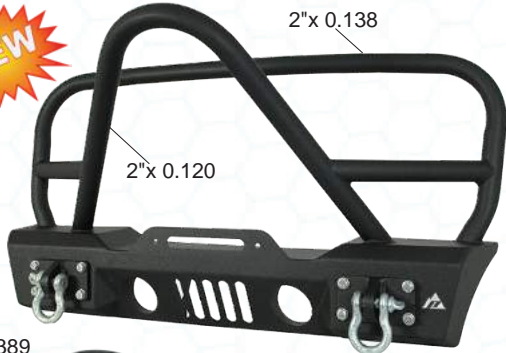

51-0389



51-0389



51-0366



51-0366



Paramount Automotive JK Full Width LED Bumpers look great and offer maximum protection from on and off-road hazards and debris. These bumpers come with integrated LED lights for increased visibility and a built-in winch plate capable of supporting a 12,000 lbs. winch. D-Rings are included on mounts that are welded both front and back for extra strength when winching out of a tight spot.

FEATURES

- Full width front bumpers provide great looking on street.
- Powerful LED lights included.
- Wire harness and switch for LED lights are included.
- Custom designed and plastic mold injection LED light housing included in 51-0370.
- Manufactured from durable 5/32" steel sheet and 2"x 0.120 steel tube.
- High strength D-Ring mounts are welded both inside and outside.
- Built-in winch plate supports up to a 12000 lbs winch.
- D-rings included – 4.75 ton capacity each.
- 2" standard hitch receiver included for rear bumper.
- High quality textured powder coat for corrosion protection and durability.
- 90 Days limited warranty on LED lights.
- Easy bolt-on installation.



51-0370

PART #	YEAR	APPLICATION
51-0370	07-17	JK LED Power Front Bumper
51-0377	07-17	JK Full Width Front Bumper with LED Lights
51-0378	07-17	JK Full Width Front Bumper with LED Lights



12W LED Light

120W LED Light

51-0370



51-0377



12W LED Light

51-0377



12W LED Light

51-0378



51-0378

JK LED Bumpers

Our JK LED bumpers are extremely popular. Providing great looks and big time protection these bumpers are an excellent addition to any JK. They come complete with integrated LED light for increased visibility and a built-in winch plate capable of supporting up to a 12000 lbs winch. D-Rings are included with mounts welded both front and back for extra strength when winching out of tight spot.

FEATURES

- Powerful LED lights included.
- Wire harness and swith for LED lights are included.
- Custom designed and plastic mold injection LED light housing for both style LED lights.
- Manufactured from durable 5/32" steel sheet and 2"X0.120 steel tubing.
- High strength D-Ring mounts are welded both inside and outside.
- Built-in winch plate supports up to a 12000 lbs winch.
- D-rings included – 4.75 ton capacity each.
- High quality textured powder coat for corrosion protection and durability.
- 90 Days limited warranty on LED lights.
- Easy bolt-on installation.



51-0353



51-0308L



51-0307L



51-0310L

PART #	YEAR	APPLICATION
51-0353	07-17	Rock Crawler Front Bumper with LED Lights with Receiver
51-0308L	07-17	Heavy Duty Rock Crawler Front Bumper with LED Lights
51-0307L	07-17	Xtreme Front Bumper with LED Lights
51-0310L	07-17	Rear Bumper with Two LED Lights



51-0353

4W LED Light

15W LED Light

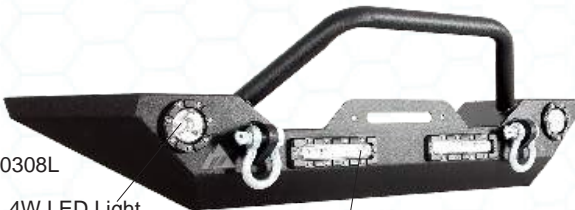

51-0308L

4W LED Light

15W LED Light



51-0307L

4W LED Light



51-0310L

12W LED Working Light
up - down direction adjustable



Our JK LED bumpers are extremely popular. Providing great looks and big time protection these bumpers are an excellent addition to any JK. They come complete with integrated LED light for increased visibility and a built-in winch plate capable of supporting up to a 12000 lbs winch. D-Rings are included with mounts welded both front and back for extra strength when winching out of tight spot.

FEATURES

- Powerful LED lights included.
- Wire harness and swith for LED lights are included.
- Customer designed and plastic mold injection LED light housing.
- Manufactured from durable 5/32" steel sheet and 2"X0.120 steel tubing.
- High strength D-Ring mounts are welded both inside and outside.
- D-rings included – 4.75 ton capacity each.
- Two way adjustable tire mount for up to 41" tire for tire carrier.
- 2" standard hitch receiver included.
- Billet Aluminum handle for Rear Tire Carrier Release included.
- High quality textured powder coat for corrosion protection and durability.
- Third brake light mount with plug extension included in the rear tire carrier.
- 90 Days limited warranty on LED lights.
- Easy bolt-on installation.



51-0390

PART #	YEAR	APPLICATION
51-0390	07-17	JK LED Front Bumper
51-0331	07-17	Offroad Front Bumper with LED Lights
51-0315L	07-17	Rear Bumper with Tire Carrier With Two LED Lights



51-0390

72W LED Light



51-0331



51-0331

4W LED Light

15W LED Light

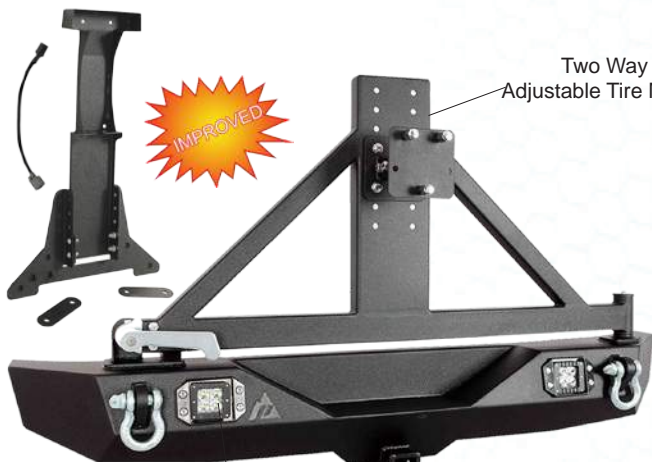

51-0315L

12W LED Light

2" Receiver Hitch

Two Way Adjustable Tire Mount



51-0315L

JK Full Width Front Bumpers with OE Fog Light Housing

Paramount Automotive JK Full Width Bumpers offers maximum protection and matching the factory fender flares.

FEATURE

- Full width front bumpers provide great looks on the street.
- OE fog light housing retained.
- Manufactured from durable 5/32" steel sheet and 2"x0.120 steel tube.
- High strength D-ring mounts are welded both inside and outside.
- Built-in Winch plate supports up to a 12000 lbs winch.
- D-rings included – 4.75 ton capacity each.
- High quality textured powder coat for corrosion protection and durability.
- Easy bolt-on installation.



51-0359



51-0360



51-0361



51-0358



51-0352

PART #	YEAR	APPLICATION
51-0359	07-17	JK Full Width R7 Front Bumper
51-0360	07-17	JK Full Width R8 Front Bumper
51-0361	07-17	JK Full Width Discover Front Bumper
51-0358	07-17	JK Full Width R6 Front Bumper
51-0352	07-17	JK Full Width Premium Front Bumper





Paramount Automotive JK Full Width Rear Bumpers offer the same notable features as our full width front bumpers. Affording maximum protection they still align with factory fender flares. You can also choose bumpers with or without the tire carriers. Our tire carriers are adjustable and can handle a 37" tire with ease. Superior aluminum latch with cam-lock and compressing bushing remove the vibration and rattles.

FEATURE

- Full width front bumper provide great looks on the street.
- Manufactured from durable 5/32" steel sheet.
- High strength D-ring mounts are welded inside and out.
- D-rings included – 4.75 ton capacity each.
- Two way adjustable tire mount for up to 41" tire for tire carrier.
- 2" standard hitch receiver included.
- Billet aluminum handle for rear tire carrier included.
- High quality textured powder coat for corrosion protection and durability.
- Third brake light mount with plug extension included in the rear tire carrier.
- Easy bolt-on installation.

PART #	YEAR	APPLICATION
51-0363	07-17	JK Full Width Rear Bumper
51-0364	07-17	JK Full Width Rear Bumper with tire carrier
51-0369	07-17	JK Full Width R6 Rear Bumper
51-0375	07-17	JK Full Width R6 Rear Bumper with Tire Carrier



51-0363



51-0364



51-0369



51-0375



51-0363



51-0364



51-0369



51-0375

JK Stubby Bumpers

Paramount Automotive JK Stubby Bumpers are perfect for challenging off-road terrain. Designed to allow for steep attack angles and maximum tire clearances. Paramount Stubby bumpers are constructed with a built-in winch plate capable of supporting up to a 12000 lbs winch.

FEATURES

- Stubby front bumpers provide great off-road experience.
- OE fog light housing.
- Manufactured from durable 5/32" steel sheet and 2 3/8"x0.140 steel tubing.
- High strength D-ring mounts are welded both inside and outside.
- Built-in winch plate supports up to a 12000 lbs winch.
- D-rings included – 4.75 ton capacity each.
- High quality textured powder coat for corrosion protection and durability.
- Easy bolt-on installation.

PART #	YEAR	BUMPER
51-0350	07-17	JK Stubby Front Bumper
51-0357	07-17	S3 Stubby Front Bumper
51-0397	07-17	JK Stubby Front Bumper
51-0368	07-17	JK R6 Stubby Rear Bumper



51-0350



51-0357



51-0367



51-0368

304 Stainless Steel End Cap



51-0350

For OE Fog Light



51-0357



51-0367



51-0368



Paramount Automotive JK Front Bumpers with OE Fog Light compatibility are the perfect upgrade for those seeking increased protection and style while retaining factory fog light function. These bumpers are available in both stubby and full width designs.

FEATURES

- Off-road front bumpers provide great off-road experience.
- OE fog light housing.
- Manufactured from durable 5/32" steel sheet and 2"x0.120 steel tubing.
- High strength D-ring mounts are welded both inside and outside.
- Built-in winch plate supports up to a 12000 lbs winch.
- D-rings included – 4.75 ton capacity each.
- High quality textured powder coat for corrosion protection and durability.
- Easy bolt-on installation.

PART #	YEAR	BUMPER
51-0307	07-17	JK Xtreme Front Bumper
51-0328	07-17	JK R3 Front Bumper
51-0329	07-17	JK R4 Front Bumper
51-0309	07-17	JK Rock Crawler Sports Front Bumper
51-0373	07-17	JK R9 Front Bumper



JK Tubular Bumpers Cont.

Paramount Automotive tubular bumpers are a modern twist on a classic design. Available in full width styles.

FEATURES

- Off-road front bumper provide great off-road experience.
- Manufactured from durable 5/32" steel sheet and 2"X0.120 steel tubing.
- High strength D-Ring mounts are welded both inside and outside.
- Built-in Winch plate supports up to a 12000 lbs winch.
- D-rings included – 4.75 ton capacity each.
- 2" standard hitch receiver included for rear bumper.
- Billet aluminum handle for rear tire carrier included.
- High quality textured powder coat for corrosion protection and durability.
- Third brake light mount with plug extension included in the rear tire carrier.
- Easy bolt-on installation.



51-0301

PART#	YEAR	APPLICATION
51-0301	07-17	JK R1 Front Bumper
51-0303	07-17	JK R1 Rear Bumper
51-0326	07-17	JK R1 Rear Bumper with Tire Carrier



51-0301



51-0303



51-0303



51-0326



51-0326



JK Rock Crawler Bumpers from Paramount Automotive offer a muscular design with maximum coverage. Form and function prevail as they keep your Jeep safe from hazards in even the tightest off-road conditions.

FEATURES

- Off-road front bumper provide great off-road experience.
- Manufactured from durable 5/32" steel sheet and 2"X0.120 steel tubing.
- High strength D-Ring mounts are welded both inside and outside.
- Built-in Winch plate supports up to a 12000 lbs winch.
- D-rings included – 4.75 ton capacity each.
- Two way adjustable tire mounts up to a 41" tire.
- 2" standard hitch receiver included for rear bumper.
- Billet Aluminum handle for Rear Tire Carrier Release included.
- High quality textured powder coat for corrosion protection and durability.
- Third brake light mount with plug extension included in the rear tire carrier.
- Easy bolt-on installation.



51-0308



51-0327

PART #	YEAR	BUMPER
51-0308	07-17	JK Heavy Duty Rock Crawler Front Bumper
51-0327	07-17	JK R2 Front Bumper
51-0325	07-17	JK X1 Rear Bumper with Tire Carrier
51-0315	07-17	JK Heavy Duty Rock Crawler Rear Bumper with Tire Carrier



51-0308



51-0327



51-0325



51-0325



51-0315



51-0315

TJ,YJ,CJ Rock Crawler Armor

Paramount Automotive Rock Crawler Armor is crafted to protect Jeeps on even the harshest terrain. Utilizing precision engineering and solid construction, Rock Crawler Armor provides maximum tire clearance and complete protection.

FEATURE

- Manufactured from durable 5/32" steel sheet and 2"X0.120" tube.
- Black textured powder coat for corrosion protection and durability.

PART #	YEAR	APPLICATION
51-0039	97-06	TJ Rocker Guard*
51-0041	97-06	TJ Front Fender**
51-0042	97-06	TJ Front Fender with Flair**
51-0043	97-06	TJ Corner Guard*
51-0044	97-06	TJ Rear Fender
51-0104	87-96	YJ Rocker Guard*
51-0105	87-96	YJ Rocker Guard with Step*
51-0106	87-96	YJ Front Fender**
51-0107	87-96	YJ Front Fender with Flair**
51-0108	87-96	YJ Corner Guard*
51-0109	87-96	YJ Rear Fender
51-0204	76-86	CJ Rocker Guard with Step*
51-0205	76-86	CJ Front Fender**
51-0206	76-86	CJ Front Fender with Flair**
51-0207	76-86	CJ Corner Guard*
51-0208	76-86	CJ Rear Fender



51-0039



51-0042



51-0043

51-0044



51-0039



51-0041



51-0042



51-0043



51-0044



When adventure and skill surpass the capacity of the OE running boards, Paramount Automotive Rock Sliders offer the solution. The sleek design and impenetrable protection offer piece of mind knowing your Jeep will return in the same condition as when you left.

FEATURES

- Manufactured from durable 2"X0.120" tube.
- Black textured powder coat finish.

PART #	YEAR	APPLICATION
51-0001	87-06	Tubular Side Armor*
51-0002	87-06	Tubular Rocker Guard*
51-0036	97-06	TJ Evolution Rocker Guard
51-0040	97-06	TJ Rocker Guard with Step*

*Drilling required

**Drilling cutting required



51-0001



51-0002



51-0036



51-0040



51-0001



51-0002



51-0036



51-0040

TJ, YJ Rock Crawler Bumpers

Paramount Automotive TJ, YJ Classic style bumpers highlight a classic design with a modern appeal. These are available in both stubby and full width designs.

FEATURES

- Manufactured from durable 5/32 steel sheet and 2"x0.120 steel tubing.
- D-Ring mounts welded both inside and out for increased strength.
- D-Rings included - 4.75 ton capacity each.
- Built in winch plate mounts most 12000 lbs. winches.
- 2" standard hitch receiver included in rear bumpers.
- Billet aluminum handle for rear tire carrier included.
- Adjustable tire mount for rear tire carrier included.
- Black textured powder coat finish.
- 90 Days limited warranty on LED lights.

PART #	YEAR	APPLICATION
51-0034	87-06	YJ/TJ Front Bumper
51-0034L	87-06	YJ/TJ Front Bumper with LED Lights
51-0051	87-06	YJ/TJ Sport Front Bumper



51-0034



51-0034L



51-0051



51-0015



51-0034



51-0034L

4W



51-0051

Adjustable Tire Mount



51-0015



Paramount Automotive TJ, YJ Classic style bumpers highlight a classic design with a modern appeal. These are available in both stubby and full width designs.

FEATURES

- Manufactured from durable 3/16 steel sheet and 2"x0.120 steel tube.
- High strength D-Ring Mounts are welded both inside and outside.
- D-Rings included - 4.75 ton capacity each.
- Tiger textured black powder coat for corrosion protection and durability.
- 90 Days limited warranty on LED lights.

PART#	YEAR	APPLICATION
51-0027	87-06	YJ/TJ Classic Stinger
51-0029	87-06	YJ/TJ Xtreme Front Bumper
51-0029L	87-06	YJ/TJ Xtreme Front Bumper with LED Lights
51-0037	87-06	YJ/TJ R2 Front Bumper



51-0027



51-0029



51-0029L



51-0037



2"x0.138 seamless steel tube

51-0027



51-0029



51-0029L

4W



51-0037

TJ, YJ Tubular Bumpers

Paramount Automotive TJ, YJ Classic style bumpers highlight a classic design with a modern appeal. These are available in both stubby and full width designs.

FEATURES

- Manufactured from durable 5/32 steel sheet and 2"x0.120 steel tubing.
- D-Ring mounts welded both inside and out for increased strength.
- D-Rings included - 4.75 ton capacity each.
- 2" inch standard hitch receiver included in rear bumpers.
- Billet Aluminum handle for Rear Tire Carrier Release included.
- Adjustable Tire Mount for Rear Tire Carrier included.
- Black textured powder coat finish.



51-0000

PART #	YEAR	APPLICATION
51-0000	87-06	TJ/YJ Front Bumper
51-0003	87-06	TJ/YJ Rear Bumper
51-0004	87-06	TJ/YJ Rear Bumper with Tire Carrier



51-0000



51-0003



51-0003



Adjustable Tire Mount

51-0004



51-0004



Paramount Automotive TJ, YJ Classic style bumpers highlight a classic design with a modern appeal. These are available in both stubby and full width designs.

FEATURES

- Manufactured from durable 5/32 steel sheet and 2 3/8"X 0.120 steel tubing.
- D-Ring mounts welded both inside and out for increased strength.
- D-Rings included - 4.75 ton capacity each.
- 2" inch standard hitch receiver included in rear bumpers.
- Adjustable Tire Mount for Rear Tire Carrier included.
- Black textured powder coat finish.

PART #	YEAR	APPLICATION
51-0007	87-06	TJ/YJ Classic Front Bumper
51-0008	87-06	TJ/YJ Classic Rear Bumper
51-0035	87-06	TJ/YJ Rock Crawler Sports Front Bumper
51-0054	87-06	TJ/YJ Rear Bumper with Tire Carrier
51-0009	87-06	TJ/YJ Rear Bumper with Tire Carrier



51-0007



51-0008



51-0035



51-0054



51-0009

Adjustable Tire Mount

Billet Aluminum handle for Rear Tire Carrier Release included



51-0007



51-0008



51-0035



51-0054



51-0009

Traildriver TJ,YJ Fender Flares

Paramount Traildriver Jeep flares combine tough protection with elegant styling to enhance and safeguard your Jeeps appearance. Made from high impact thermoformed materials our flares combine maximum durability and flexibility with rugged good looks. Whether driving on the street or your favorite off-road trail these flares will protect your Jeep from any road condition. Easy-Install no-drill design makes installation fast and simple. Made with pride in the USA .



FEATURES

- Larger tire coverage for street legal driving.
- No drill installation on most models.
- Constructed of heavy duty proguard plastic (c) . Offers 100% uv protection for maximum durability.
- Comes standard in matte black oem textured finish.
- Can be painted to match the jeep color if desired.
- Easy to install. Requires basic tools.
- Includes all installation, mounting hardware, and instructions.

PART #	YEAR	APPLICATION
58-0301	97-06	TJ Bolt-on Style Pocket Fender Flares
58-0302	87-95	YJ Rivet/Pocket Textured Fender Flare
58-0303	97-06	TJ Wrangler 4pcs Flat-Style Fender Flare



58-0301



58-0301



58-0302



58-0302



58-0303



58-0303



Paramount Automotive's Light Mounting Brackets have been designed and crafted so that lights can be mounted onto Jeeps in any way imaginable.



51-0451



51-0475



51-0462



51-0469



51-0470



51-0472



51-0464



51-0453



51-0454



51-0459



51-0452



51-0468

PART#	YEAR	MAKE	MODE	APPLICATION
51-0451	07-17	Jeep	Wrangler JK	Windshield Mounting Brackets for 52" & 2" LED Lights
51-0475	07-17	Jeep	Wrangler JK	52" LED Light Bar Steel Metal Upper Windshield Mounting Brackets
51-0462	07-17	Jeep	Wrangler JK	LED Lights Windshield Mounting Brackets with Adjustable Tabs
51-0469	07-17	Jeep	Wrangler JK	Double 52" LED Light Bars Mounting Kit
51-0470	07-17	Jeep	Wrangler JK	Windshield A-Pillar Mount Brackets for Dual LED Lights
51-0472	07-17	Jeep	Wrangler JK	20" LED Light Bar Bracket Mount Through Grille
51-0464	07-17	Jeep	Wrangler JK	Hood 20" LED Bar Mounting Kit
51-0453	97-06	Jeep	Wrangler JK	Windshield Hinge Lower Corner Brackets
51-0454	97-06	Jeep	Wrangler JK	Upper Windshield Hinge Light Side Mounting Brackets
51-0459	07-17	Jeep	Wrangler JK	Elevated CHMSL Third Brake Light Mounting Bracket
51-0452	97-06	Jeep	Wrangler JK	Windshield Mounting Brackets for 52" & 2" LED Lights
51-0468	97-06	Jeep	Wrangler JK	Hood Brackets Mounting Kits for 20" LED Light Bar

Jeep Wrangler Grilles



46-0230CF (07-17)



46-0230 (07-17)



48-0830 (07-17)

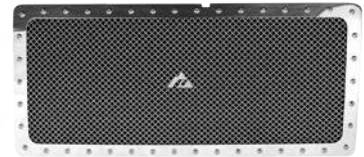

46-0631 (07-17)

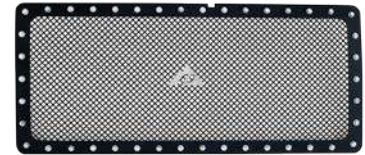

46-0731 (07-17)

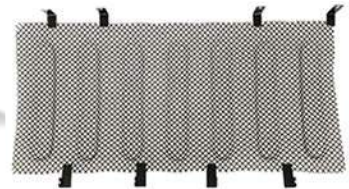

43-0340B (07-17)

Paramount Automotive's Grille line has expanded to the Jeep market with our Evolution Mesh Grilles and assorted ABS Grille for a completely customized look.



41-0135B (07-17)



41-0135 (07-17)



30-0105 (07-17)



41-0137 (07-17)

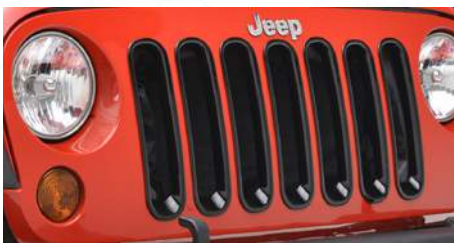

41-0136B (07-17)



48-0931 (07-17)



Paramount Automotive's Grille line has expanded to the Jeep market with our Evolution Mesh Grilles and assorted ABS Grille for a completely customized look.



42-0215 (07-17)

46-0330 (07-17)



30-0109 (97-06)

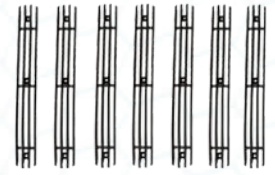

30-0109B (97-06)



41-0138 (97-06)



41-0139 (97-06)

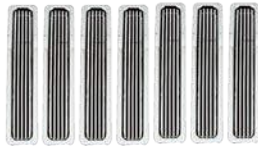

42-0216 (97-06)



42-0216B (97-06)



42-0523B (97-06)



42-0523 (97-06)

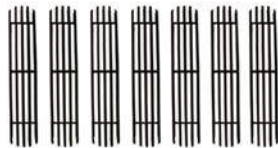

30-0105B (07-17)



42-0215B (07-17)

41-0138 (97-06)



42-0522B (07-17)

43-0340 (07-17)



42-0522 (07-17)

Jeep Wrangler Soft Goods

Paramount Automotive's Soft Goods provide everything necessary to complete the interior of any Jeep, adding functionality while maintaining that Jeep look.

Grab Handles

Constructed of tough nylon webbing. Deluxe and Sport models fit all Wrangler roll bars and 3" roll cages with padding. All designs are packed in pairs.

51-9315
Rear Grab Handles (pair)



51-9310
Extreme Sport Grab Handles (pair)



51-9301 Deluxe Sport Handles



51-9201 Standard Grab Handles



Rear Side Grabe Handles for easy entry and exit attach directly into factory mounting holes with your original hardware. Reat Seat Grab Handles attach to the head rest of your JK front seats.

Flashlight Holders

Keep your flashlight where you know it will always be.

Fire Extinguisher Holder

Special designed holder incorporates thick nylon web straps that secures your fire extinguisher to the roll bar. Straps are fully adjustable and loop fasteners.

51-9520 Mag Light Holder



51-9550 Mini Flash Light Holder



51-9530 (1 lb)



51-9540 (2.5 lb)



51-9401 Adjustable Door Strap (pair)



51-9501 Off Road Organizer



51-9510 CB/Phone Holder



51-9901 Roll Bar Drink Holder



Adjustable Door Strap

Made from highly durable weather resistant outdoor grade fabric. Helps keep any door manageable. Allows door to open to desired position. Ensures easy installation. Requires no tools.

Adjustable Door Strap

Special quad fold design holds owners manuals, maps, tools, and other vehicle paperwork. Clear registration/insurance card pocket keeps vehicle registration and insurance information handy.

CB/PHONE Holder

Durable padded holder attaches with heavy duty hook and loop straps. Great for every Off Roder.

Roll Bar Drink Holder

Durable padded drink holders attach to your roll bar with heavy duty hook and loop straps.



Paramount Automotive's Accessories are designed to maximize the functionality of Jeeps, so that they can do everything imaginable.



51-0489
JK Raised Winch Mounting
Steel Plate for Factory Bumper



51-0530

Black Receiver Hitch with
Yellow 4.75T D-Ring and black



51-0333
87-17 Jeep Wrangler YJ,TJ,JK
Rear Cargo Basket (Only fit's
Paramount rear tire carrier)



51-0465
Rear License Plate Bracket (US)



51-0529

Black Receiver Hitch with Red
4.75T D-Ring and yellow isolator



51-0516
Black D-Ring (4.75 Ton, Single)
with red Isolator



51-0517
Black D-Ring (4.75 Ton, Single)
with Yellow Isolator



51-0518
Yellow D-Ring (4.75 Ton, Single)
with Red Isolator



51-0519
Yellow D-Ring (4.75 Ton, Single)
with Black Isolator



51-0520
Red D-Ring (4.75 Ton, Single)
with Black Isolator



51-0521
Red D-Ring (4.75 Ton, Single)
with Yellow Isolator



51-0528

Black Receiver Hitch with Black
4.75T D-Ring and red isolator



51-0024
Natural Finish D-Ring (4.75 Ton)



51-0053
10" Aluminum Billet fairlead
for Synthetic Winch Rope with
hardware



51-0337
Universal Vacuum Relocation Bracket



51-0444
JK Factory Style Black Class 3
2" Receiver Tow Hitch



51-0487
Universal Winch Roller Fairlead
License Plate Holder Bracket Mount



51-0445
JK Spare Tire Relocation
Mounting Bracket



51-0339
07-11 Jeep Wrangler Skid Row
Engine/Transmission Skid Plate



2801
TJ/YJ Winch Plate

Contractor Racks

Paramount Automotive's Contractor's Racks are designed for the workforce to add functionality to any truck. The adjustable rack design and durable engineering guarantee that these racks will install solidly on any truck.

FEATURES:

- Racks can be adjusted to fit long-bed and short-bed trucks.
- Convenient rear grab handles.
- Sturdy rope ties on each upright.
- Round tube design to minimize road noise.
- All joints fit securely for a tight, strong, fit.
- Center cross member is fully adjustable to support large or small loads and properly distribute weight.
- Front air dam to reduce wind noise.
- Rear cross member is easily removable for carrying tall cargo.
- Durable black powder-coat finish.
- All racks are rated to support loads up to 1000 pounds.
- No drill installation with supplied J-Hooks or permanently mounted with supplied hardware.
- Ships in two boxes via UPS & FED EX.

PART #	Contractor Racks	LOADS
16601	Compact Rack	1000lbs
18601	Regular Rack	1000lbs
19601	Camper Shell Rack	1000lbs
18606	Extension for Crew Cabs	



18601 Full Size Contractor Rack

A. Overall length of rack 10'9"

B. Width of rack at top 63"

C. Height of rack to bottom rail 37"

Ships in 2 boxes. Box size: 69"x15"x7"

Shipping Weight 156 lbs

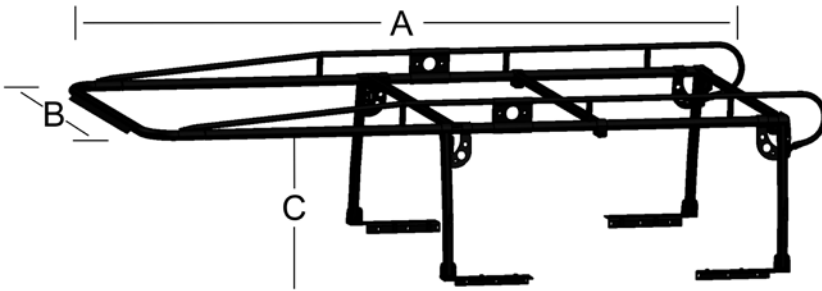

18606 Extension for Crew Cabs



Tie down on every leg



Heavy-duty design



Wind Deflector Eliminates Cab Noise

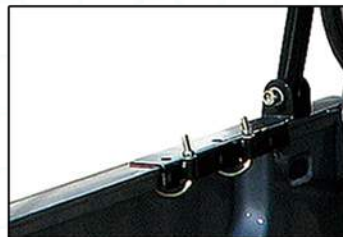

Easy no drill install



Removable rear bar

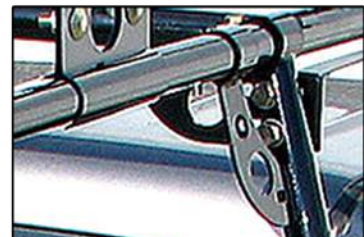

Adjustable for universal fit



Paramount Automotive professional truck racks combine Impressive Strength, Elegant design and ease of installation. Our unique design allows for infinite adjustability in all the right places for a custom fit on all trucks - long bed or short bed. Included with all of our racks is a no-drill mounting allowing for a rock solid installation without the need to drill your truck bed rail. With standard features such as front air dam to eliminate road noise and fully adjustable and removable mid and rear cross bars we offer the best combination of style, performance, and value in the industry.

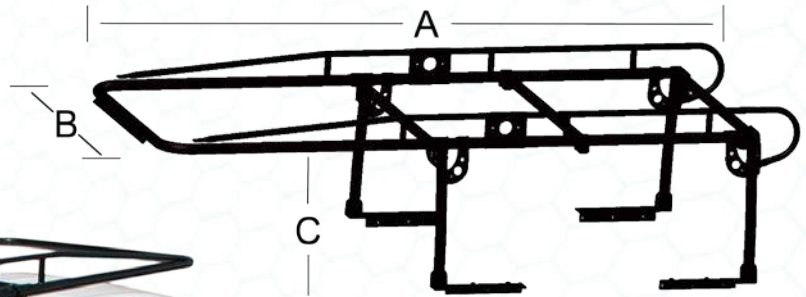

16601 Compact Rack

A. Overall length of rack 10'6"

B. Width of rack at top 55"

C. Height of rack to bottom rail 34"

Ships in 2 boxes. Box size: 64"x15"x7"

Shipping Weight 151 lbs

19601 Camper Shell Rack

A. Overall length of rack 11'6"

B. Width of rack at top 72"

C. Height of rack to bottom rail 41"

Ships in 2 boxes. Box size: 71"x17"x7"

Shipping Weight 180 lbs

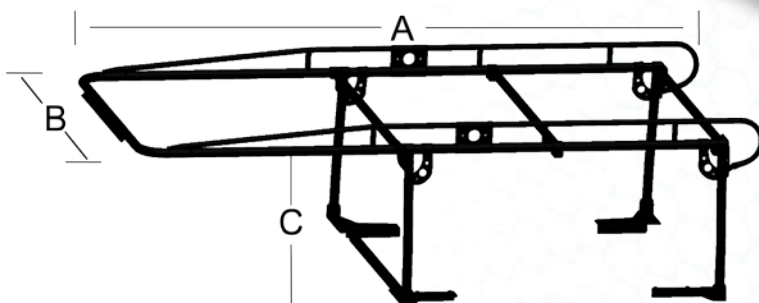

Contractor Racks Cont.

Paramount Automotive professional truck racks combine Impressive Strength, Elegant design and ease of installation. Our unique design allows for infinite adjustability in all the right places for a custom fit on all trucks - long bed or short bed. Included with all of our racks is a no-drill mounting allowing for a rock solid installation without the need to drill your truck bed rail. With standard features such as front air dam to eliminate road noise and fully adjustable and removable mid and rear cross bars we offer the best combination of style, performance, and value in the industry.

FEATURES

- Gold zinc-Plated, Grade- 8 hardware provides maximum, strength and durability.
- Racks can be adjusted to fit long-bed and short-bed trucks.
- Convenient rear grab handles.
- Sturdy rope ties on each upright.
- Round tube design to minimize road noise.
- All joints fit securely for a tight, strong, fit.
- Center cross member is fully adjustable to support large or small loads and properly distribute weight.
- Front air dam to reduce wind noise.
- Rear cross member is easily removable for carrying tall cargo.
- Durable black powder-coat finish.
- All racks are rated to support loads up to 1000 pounds.
- Limited 1-year warranty against manufacture defects.
- No drill installation with supplied J-Hooks or permanently mounted with supplied hardware.

PART#	Contractor Racks	LOADS
18602	Premium Rack	1500lbs



Wind Deflector Eliminates Cab Noise



Easy no drill install



Heavy Duty Design



Gusseted Corners



Removable Rear Cross Bar



Tie down on every leg

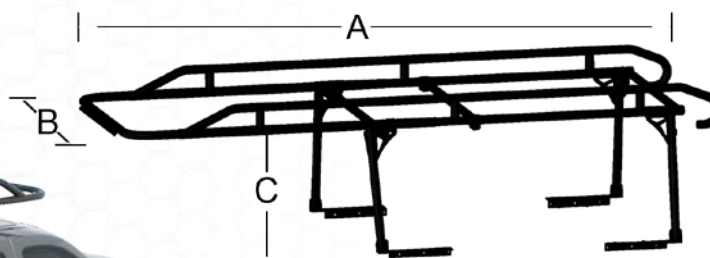

18602 Compact Rack

A. Overall length of rack 11'9"

B. Width of rack at top 66"

C. Height of rack to bottom rail 39"

Ships in 2 boxes. Box size: 72"x16"x8"

Shipping Weight 173 lbs



Paramount Automotive's Racks are crafted to add functionality however its needed. With a rugged construction and high weight capacity, these racks will make sure that the job gets done.

Cab Rack

Part Number: 17611

- No drilling required.
- Hardware included for permanent installation.
- Rack can be removed in minutes.
- Round tube design to minimize road noise.
- Built in tie downs.
- 500lbs weight capacity.



Ladder Cab Rack

Part Number: 17612

- Black powder coat finish.
- No drilling required.
- Hardware included for permanent installation.
- Rack can be removed in minutes.
- Tubular design to minimize road noise.
- Built in tie down.
- 500lbs weight capacity.



Van Rack

Part Number: 17614

- Black powder coat finish.
- No drilling required.
- Hardware included for permanent installation.
- Easily removed in minutes.
- 500lbs weight capacity.



PART#	CONTRACTOR RACKS	LOADS
17611	Cab Rack	500 lbs
17612	Ladder Cab Rack	500 lbs
17614	Van Rack	500 lbs
17613	Side-Mounted Ladder Rack	250 lbs
1990	Hitch Rack	750 lbs

Side-Mounted Ladder Rack

Part Number: 17613

- Black powder coat finish.
- Provide maximum utility with minimum space.
- No drilling required.
- Hardware included for permanent installation.
- Rack can be removed in minutes.
- 250lbs weight capacity.



Hitch Rack

Part Number: 1990

Hauling long and off balanced cargo in pickup trucks just got easier! The hitch rack will safely support and secure many different loads. It also adjusts to assist in carrying long loads attached to a vehicle's roof rack.

- Supports loads of up to 750 pounds.
- Tilts downward for a convenient work surface.
- Hitch rack mounts vertically on most trucks and SUV's to help balance.
- Two piece design for easy storage.
- Made from 1/4" thick, 2" square tube for superior strength and durability.
- Includes safety flag.



Jeep Wrangler JK Light Guards

Paramount Automotive's Light Guards install in minutes and offer added protection while out on the trail.

Steel Light Guards

FEATURES

- Protect and upgrade the look of your Wrangler.
- Made from stainless and mild steels.
- Tiger textured black powder coat or chromed.
- Easy to install with no drilling required.

PART#	YEAR	MAKE	MODEL	APPLICATION
51-0460	07-17	Jeep	Wrangler JK	Black Stainless Euro Metal Tail Light Guard Cover
51-0461	07-17	Jeep	Wrangler JK	Chrome Stainless Euro Metal Tail Light Guard Cover
51-0447	07-17	Jeep	Wrangler JK	Black Stainless Billet Tail Light Guard Cover
51-0448	07-17	Jeep	Wrangler JK	Chrome Stainless Billet Tail Light Guard Cover
51-0494	07-17	Jeep	Wrangler JK	Jeep Style Tail Light Guard Cover
51-0495	07-17	Jeep	Wrangler JK	Tubular Light Guards(Headlight, Turn signal, Sider Marker)
51-0496	07-17	Jeep	Wrangler JK	Frame Light Guards(Headlight, Turn signal, Sider Marker)
51-0500	07-17	Jeep	Wrangler JK	Captain American Tail Light Guard
17301	07-17	Jeep	Wrangler JK	Traildriver ABS Black Tail Light Guards



51-0447



51-0448



51-0500



51-0494



51-0460



51-0461



51-0495



51-0496



17301

Traildriver ABS Black Tail Light Guards

FEATURES

- Custom designed covers face and side of factory tail light for total protection
- Made from our proprietary Co-extruded Proguard ABS plastic for maximum UV protection
- Available in Black satin finish. Can be painted to match your vehicle
- No Drill design installs in factory holes using factory mounting screws
- Made in the USA



Paramount Automotive



Discover other off-road bumpers on our website.