

# O-RING

321239



**Description:** O-RING  
**SKU:** 321239  
**OEM:** 3J7354  
**Product Group:** ENGINE PARTS  
**Product Class:** OIL COOLERS & RELATED  
**UPC Code:** 193807080143  
**Sell Pack:** 5 EA  
 (Available to buy in increments of 5)  
**Weight:** 0.01 LBS  
**Warranty:** 2 Years



**Details:**

O-Ring, 0.072 in x 0.351 in  
 1.83 mm x 8.92 mm, Buna N (90) Series # 3-904

**E-Catalog Pages:**

Catalog Page	Description
	<p><b>O-Rings</b>                      Parker Series 3</p>

Copyright © 2020 PAI Industries, Inc.  
 All rights reserved. All content is property of PAI Industries, Inc. and may not be reproduced or redistributed in any form.

Any reference to OEM names or OEM product identification numbers/descriptions/model numbers is for identification only and does not indicate that it is an OEM part. PAI is not affiliated with Mack Truck, Inc.®, Volvo®, Fuller®, Cummins®, Eaton®, Rockwell®, Caterpillar®, Freightliner®, Hendrickson®, Kenworth®, Detroit Diesel®, International®, Peterbilt®, or Dana®. All Manufacturer's names, numbers, symbols and descriptions are used for reference only. It is not implied that any part listed is the product of these manufacturers.

## O-RING

321239

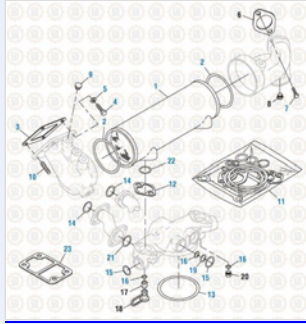

**Caterpillar Engine 2019**  
Oil Cooler - 3400 Series

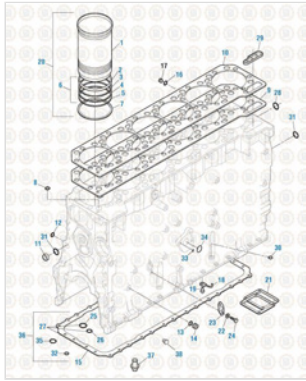

**Caterpillar Engine 2019**  
Cylinder Block - 3406E / C15 / C16 / C18 Series

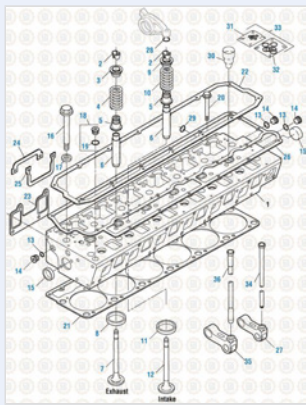

**Caterpillar Engine 2019**  
Cylinder Head - 3116 / 3126 - 3100 / C7 Series

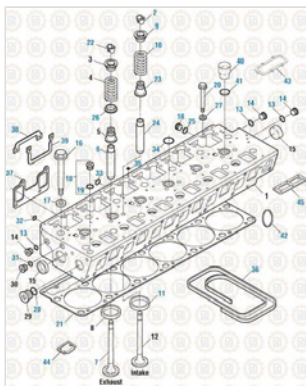

**Caterpillar Engine 2019**  
Cylinder Head - 3126B / C7 - 3100 / C7 Series

Copyright © 2020 PAI Industries, Inc.  
All rights reserved. All content is property of PAI Industries, Inc. and may not be reproduced or redistributed in any form.

Any reference to OEM names or OEM product identification numbers/descriptions/model numbers is for identification only and does not indicate that it is an OEM part. PAI is not affiliated with Mack Truck, Inc.®, Volvo®, Fuller®, Cummins®, Eaton®, Rockwell®, Caterpillar®, Freightliner®, Hendrickson®, Kenworth®, Detroit Diesel®, International®, Peterbilt®, or Dana®. All Manufacturer's names, numbers, symbols and descriptions are used for reference only. It is not implied that any part listed is the product of these manufacturers.

# O-RING

321239

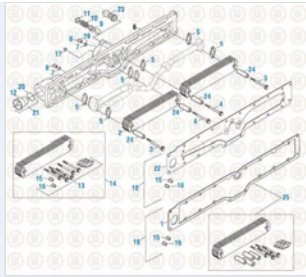

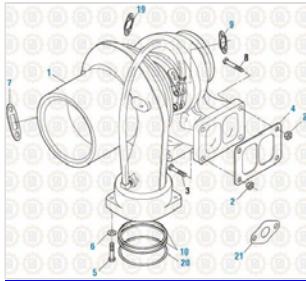

**Cummins Engine 2017**  
Oil Cooler - ISX Series



**Caterpillar Engine 2019**  
Turbocharger - 3300 Series

**Component Of:**









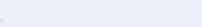

SKU	Image	Description
<a href="#">321411</a>		OIL COOLER GASKET KIT
<a href="#">331125-157</a>	-	GASKET KIT
<a href="#">331128</a>	-	OVERHAUL GASKET KIT
<a href="#">331144</a>	-	OVERHAUL GASKET KIT
<a href="#">331198</a>	-	UPPER GASKET KIT
<a href="#">331200</a>	-	UPPER GASKET KIT
<a href="#">331203-157</a>	-	GASKET KIT
<a href="#">331220</a>	-	ENGINE OVERHAUL GASKET KIT
<a href="#">331321</a>	-	LOWER GASKET KIT
<a href="#">331323</a>		OIL COOLER GASKET KIT

Copyright © 2020 PAI Industries, Inc.  
All rights reserved. All content is property of PAI Industries, Inc. and may not be reproduced or redistributed in any form.

Any reference to OEM names or OEM product identification numbers/descriptions/model numbers is for identification only and does not indicate that it is an OEM part. PAI is not affiliated with Mack Truck, Inc.®, Volvo®, Fuller®, Cummins®, Eaton®, Rockwell®, Caterpillar®, Freightliner®, Hendrickson®, Kenworth®, Detroit Diesel®, International®, Peterbilt®, or Dana®. All Manufacturer's names, numbers, symbols and descriptions are used for reference only. It is not implied that any part listed is the product of these manufacturers.

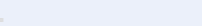
# O-RING

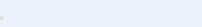
321239

<a href="#">331327</a>		FUEL PUMP GASKET KIT
<a href="#">331328</a>		UPPER GASKET KIT
<a href="#">331331-151</a>		INTAKE GASKET KIT
<a href="#">331332-157</a>		GASKET KIT
<a href="#">331333-155</a>		CYLINDER HEAD GASKET KIT
<a href="#">331334</a>		GASKET KIT
<a href="#">331362-155</a>		GASKET KIT
<a href="#">331376</a>		UPPER GASKET KIT
<a href="#">331378</a>		OIL COOLER GASKET KIT
<a href="#">331385</a>		LOWER GASKET KIT
<a href="#">331389</a>		OIL COOLER GASKET KIT
<a href="#">331391</a>		OIL COOLER GASKET KIT

Copyright © 2020 PAI Industries, Inc.  
 All rights reserved. All content is property of PAI Industries, Inc. and may not be reproduced or redistributed in any form.

Any reference to OEM names or OEM product identification numbers/descriptions/model numbers is for identification only and does not indicate that it is an OEM part. PAI is not affiliated with Mack Truck, Inc.®, Volvo®, Fuller®, Cummins®, Eaton®, Rockwell®, Caterpillar®, Freightliner®, Hendrickson®, Kenworth®, Detroit Diesel®, International®, Peterbilt®, or Dana®. All Manufacturer's names, numbers, symbols and descriptions are used for reference only. It is not implied that any part listed is the product of these manufacturers.

# O-RING

321239

[331410-155](#)



HEAD O-RING KIT

[331411-155](#)



HEAD O-RING KIT

[331413](#)



OIL COOLER GASKET KIT

[331449](#)

ENGINE OVERHAUL GASKET KIT

[331470-151](#)



INTAKE GASKET KIT

[331473-151](#)

INTAKE GASKET KIT

[331497](#)

COMPRESSOR GASKET SET

[331499](#)



OIL COOLER GASKET KIT

[331502](#)



TURBOCHARGER INSTALLATION GASKET KIT





Copyright © 2020 PAI Industries, Inc.

All rights reserved. All content is property of PAI Industries, Inc. and may not be reproduced or redistributed in any form.

Any reference to OEM names or OEM product identification numbers/descriptions/model numbers is for identification only and does not indicate that it is an OEM part. PAI is not affiliated with Mack Truck, Inc.®, Volvo®, Fuller®, Cummins®, Eaton®, Rockwell®, Caterpillar®, Freightliner®, Hendrickson®, Kenworth®, Detroit Diesel®, International®, Peterbilt®, or Dana®. All Manufacturer's names, numbers, symbols and descriptions are used for reference only. It is not implied that any part listed is the product of these manufacturers.

# O-RING

321239







<p><a href="#">331503</a></p>		<p>UPPER GASKET KIT</p>
<p><a href="#">331504</a></p>		<p>UPPER GASKET KIT</p>
<p><a href="#">331511</a></p>	<p>.</p>	<p>FRONT GASKET KIT</p>
<p><a href="#">331515</a></p>	<p>.</p>	<p>FRONT COVER GASKET KIT</p>
<p><a href="#">331516</a></p>		<p>LOWER GASKET KIT</p>
<p><a href="#">331517</a></p>	<p>.</p>	<p>COMPRESSOR GASKET KIT</p>
<p><a href="#">331538</a></p>	<p>.</p>	<p>REAR COVER GASKET KIT</p>
<p><a href="#">331539</a></p>		<p>GASKET KIT</p>
<p><a href="#">331542</a></p>		<p>UPPER GASKET KIT</p>
<p><a href="#">331554</a></p>	<p>.</p>	<p>LOWER GASKET SET</p>
<p><a href="#">331557</a></p>	<p>.</p>	<p>LOWER GASKET SET</p>
<p><a href="#">331560</a></p>	<p>.</p>	<p>UPPER GASKET KIT</p>
<p><a href="#">331561</a></p>	<p>.</p>	<p>UPPER GASKET KIT</p>

Copyright © 2020 PAI Industries, Inc.  
 All rights reserved. All content is property of PAI Industries, Inc. and may not be reproduced or redistributed in any form.

Any reference to OEM names or OEM product identification numbers/descriptions/model numbers is for identification only and does not indicate that it is an OEM part. PAI is not affiliated with Mack Truck, Inc.®, Volvo®, Fuller®, Cummins®, Eaton®, Rockwell®, Caterpillar®, Freightliner®, Hendrickson®, Kenworth®, Detroit Diesel®, International®, Peterbilt®, or Dana®. All Manufacturer's names, numbers, symbols and descriptions are used for reference only. It is not implied that any part listed is the product of these manufacturers.

## O-RING

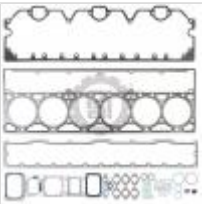
321239

<a href="#">331572</a>		FRONT COVER GASKET KIT
<a href="#">331581</a>		UPPER GASKET SET
<a href="#">331583</a>		TURBOCHARGER INSTALLATION KIT
<a href="#">331586</a>		OIL COOLER GASKET SET
<a href="#">331587</a>		OIL COOLER GASKET KIT
<a href="#">331611</a>		SINGLE CYLINDER HEAD GASKET SET
<a href="#">331648</a>		UPPER GASKET KIT
<a href="#">331664-152</a>		TURBOCHARGER GASKET KIT
<a href="#">131482-100</a>		UPPER GASKET KIT
<a href="#">131482-152</a>		TURBOCHARGER GASKET KIT
<a href="#">131683</a>		UPPER GASKET KIT









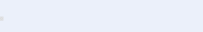

Copyright © 2020 PAI Industries, Inc.

All rights reserved. All content is property of PAI Industries, Inc. and may not be reproduced or redistributed in any form.

Any reference to OEM names or OEM product identification numbers/descriptions/model numbers is for identification only and does not indicate that it is an OEM part. PAI is not affiliated with Mack Truck, Inc.®, Volvo®, Fuller®, Cummins®, Eaton®, Rockwell®, Caterpillar®, Freightliner®, Hendrickson®, Kenworth®, Detroit Diesel®, International®, Peterbilt®, or Dana®. All Manufacturer's names, numbers, symbols and descriptions are used for reference only. It is not implied that any part listed is the product of these manufacturers.

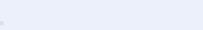
# O-RING

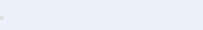
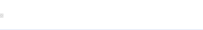
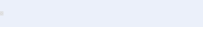
# 321239

<a href="#">131684</a>		UPPER GASKET SET
<a href="#">131718</a>		UPPER GASKET KIT
<a href="#">131734</a>		UPPER GASKET KIT
<a href="#">131743</a>		UPPER GASKET KIT
<a href="#">131814</a>		UPPER GASKET KIT
<a href="#">131815</a>		UPPER GASKET KIT
<a href="#">131816</a>		UPPER GASKET KIT
<a href="#">131863</a>		UPPER GASKET KIT
<a href="#">131864</a>		LOWER GASKET KIT
<a href="#">131867</a>		UPPER GASKET KIT
<a href="#">131880</a>		UPPER GASKET KIT
<a href="#">131906</a>		UPPER GASKET KIT
<a href="#">141440</a>		EGR COOLER INSTALLATION KIT

Copyright © 2020 PAI Industries, Inc.

All rights reserved. All content is property of PAI Industries, Inc. and may not be reproduced or redistributed in any form.

Any reference to OEM names or OEM product identification numbers/descriptions/model numbers is for identification only and does not indicate that it is an OEM part. PAI is not affiliated with Mack Truck, Inc.®, Volvo®, Fuller®, Cummins®, Eaton®, Rockwell®, Caterpillar®, Freightliner®, Hendrickson®, Kenworth®, Detroit Diesel®, International®, Peterbilt®, or Dana®. All Manufacturer's names, numbers, symbols and descriptions are used for reference only. It is not implied that any part listed is the product of these manufacturers.



## O-RING

321239

[181199](#)

TURBOCHARGER KIT

## Cross Reference:

Manufacturer	OEM Number
CATERPILLAR	06-3710
CATERPILLAR	063710
CATERPILLAR	2U5316
CATERPILLAR	3J7354
CATERPILLAR	4J2209
CATERPILLAR	5E6738
CATERPILLAR	77-3100
CATERPILLAR	77-4866
CATERPILLAR	77-5022
CATERPILLAR	773100
CATERPILLAR	774866
CATERPILLAR	775022
CATERPILLAR	7X5362
CATERPILLAR	7X8720
CATERPILLAR	8T4461
CATERPILLAR	95-1759
CATERPILLAR	951759
CATERPILLAR	98-3894
CATERPILLAR	983894
CUMMINS	3883963

Copyright © 2020 PAI Industries, Inc.

All rights reserved. All content is property of PAI Industries, Inc. and may not be reproduced or redistributed in any form.

Any reference to OEM names or OEM product identification numbers/descriptions/model numbers is for identification only and does not indicate that it is an OEM part. PAI is not affiliated with Mack Truck, Inc.®, Volvo®, Fuller®, Cummins®, Eaton®, Rockwell®, Caterpillar®, Freightliner®, Hendrickson®, Kenworth®, Detroit Diesel®, International®, Peterbilt®, or Dana®. All Manufacturer's names, numbers, symbols and descriptions are used for reference only. It is not implied that any part listed is the product of these manufacturers.