

# O-RING

# 121308



**Description:** O-RING  
**SKU:** 121308  
**OEM:** 3678756  
**Product Group:** ENGINE PARTS  
**Product Class:** OIL PANS & RELATED PARTS  
**UPC Code:** 193807090371  
**Sell Pack:** 5 EA  
 (Available to buy in increments of 5)  
**Weight:** 0.06 LBS  
**Warranty:** 2 Years



**Details:**

O-Ring, 0.21 in C/S x 1.725 in ID  
 5.33 mm C/S x 43.82 mm ID, HNBR 75, Series # -327

**E-Catalog Pages:**

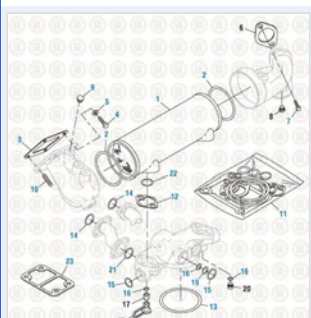
Catalog Page	Description
	<b>O-Rings</b> AS568A
	<b>Caterpillar Engine 2019</b> Oil Cooler - 3400 Series

Copyright © 2020 PAI Industries, Inc.  
 All rights reserved. All content is property of PAI Industries, Inc, and may not be reproduced or redistributed in any form.

Any reference to OEM names or OEM product identification numbers/descriptions/model numbers is for identification only and does not indicate that it is an OEM part. PAI is not affiliated with Mack Truck, Inc.®, Volvo®, Fuller®, Cummins®, Eaton®, Rockwell®, Caterpillar®, Freightliner®, Hendrickson®, Kenworth®, Detroit Diesel®, International®, Peterbilt®, or Dana®. All Manufacturer's names, numbers, symbols and descriptions are used for reference only. It is not implied that any part listed is the product of these manufacturers.

# O-RING

# 121308

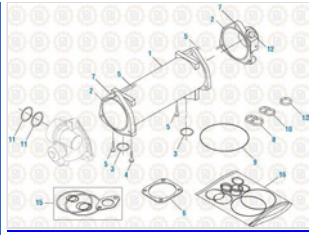

**Caterpillar Engine 2019**  
C10 and C12 - 3176 / C9 / C10 / C11 / C12 / C13 Series

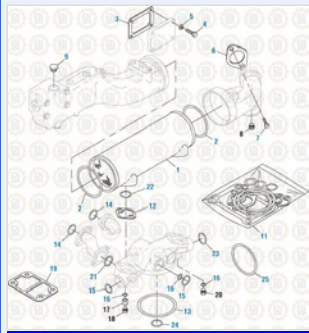

**Caterpillar Engine 2019**  
Oil Cooler - 3406E / C15 / C16 / C18 Series

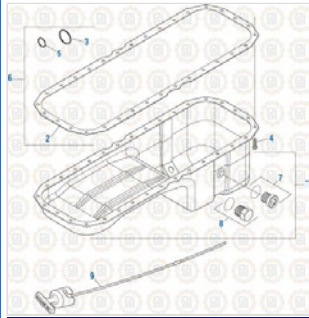

**Cummins Engine 2017**  
Oil Pan - ISX Series

**Component Of:**







SKU	Image	Description
<a href="#">321380</a>	-	O-RING KIT
<a href="#">321407</a>		O-RING KIT
<a href="#">321411</a>		OIL COOLER GASKET KIT

Copyright © 2020 PAI Industries, Inc.  
All rights reserved. All content is property of PAI Industries, Inc. and may not be reproduced or redistributed in any form.

Any reference to OEM names or OEM product identification numbers/descriptions/model numbers is for identification only and does not indicate that it is an OEM part. PAI is not affiliated with Mack Truck, Inc.®, Volvo®, Fuller®, Cummins®, Eaton®, Rockwell®, Caterpillar®, Freightliner®, Hendrickson®, Kenworth®, Detroit Diesel®, International®, Peterbilt®, or Dana®. All Manufacturer's names, numbers, symbols and descriptions are used for reference only. It is not implied that any part listed is the product of these manufacturers.

# O-RING

121308







<a href="#">321485</a>		GASKET KIT
<a href="#">331229</a>		UPPER GASKET KIT
<a href="#">331235</a>		UPPER GASKET KIT
<a href="#">331334</a>		GASKET KIT
<a href="#">331389</a>		OIL COOLER GASKET KIT
<a href="#">331390</a>		OIL COOLER GASKET KIT
<a href="#">331391</a>		OIL COOLER GASKET KIT
<a href="#">331392</a>		OIL COOLER GASKET KIT
<a href="#">331395</a>		OIL COOLER GASKET KIT
<a href="#">331413</a>		OIL COOLER GASKET KIT

Copyright © 2020 PAI Industries, Inc.  
 All rights reserved. All content is property of PAI Industries, Inc. and may not be reproduced or redistributed in any form.

Any reference to OEM names or OEM product identification numbers/descriptions/model numbers is for identification only and does not indicate that it is an OEM part. PAI is not affiliated with Mack Truck, Inc.®, Volvo®, Fuller®, Cummins®, Eaton®, Rockwell®, Caterpillar®, Freightliner®, Hendrickson®, Kenworth®, Detroit Diesel®, International®, Peterbilt®, or Dana®. All Manufacturer's names, numbers, symbols and descriptions are used for reference only. It is not implied that any part listed is the product of these manufacturers.

## O-RING

121308

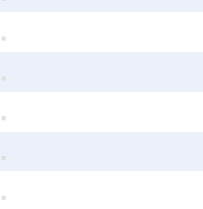
<a href="#">331431</a>		OIL COOLER GASKET KIT
<a href="#">331623</a>		OIL COOLER O-RING KIT
<a href="#">131639</a>		LOWER GASKET KIT
<a href="#">131640</a>		LOWER GASKET KIT
<a href="#">131838</a>		OIL PAN GASKET KIT
<a href="#">131851</a>		LOWER GASKET KIT
<a href="#">ISX140-017</a>		ENGINE KIT
<a href="#">ISX140-017HP</a>		HIGH PERFORMANCE ENGINE KIT
<a href="#">ISX140-033</a>		PISTONLESS ENGINE KIT
<a href="#">ISX140-034</a>		PISTONLESS ENGINE KIT
<a href="#">ISX140-049</a>		PISTONLESS ENGINE KIT
<a href="#">ISX140-054</a>		PISTONLESS ENGINE KIT
<a href="#">ISX140-065</a>		PISTONLESS ENGINE KIT
<a href="#">ISX141-017</a>		PISTONLESS ENGINE KIT
<a href="#">ISX141-017HP</a>		HIGH PERFORMANCE ENGINE KIT
<a href="#">ISX141-018</a>		PISTONLESS ENGINE KIT
<a href="#">ISX141-022</a>		PISTONLESS ENGINE KIT

Copyright © 2020 PAI Industries, Inc.

All rights reserved. All content is property of PAI Industries, Inc. and may not be reproduced or redistributed in any form.

Any reference to OEM names or OEM product identification numbers/descriptions/model numbers is for identification only and does not indicate that it is an OEM part. PAI is not affiliated with Mack Truck, Inc.®, Volvo®, Fuller®, Cummins®, Eaton®, Rockwell®, Caterpillar®, Freightliner®, Hendrickson®, Kenworth®, Detroit Diesel®, International®, Peterbilt®, or Dana®. All Manufacturer's names, numbers, symbols and descriptions are used for reference only. It is not implied that any part listed is the product of these manufacturers.

## O-RING

121308

<a href="#">ISX141-025</a>	.	ENGINE KIT
<a href="#">ISX141-026</a>	.	PISTONLESS ENGINE KIT
<a href="#">ISX141-027</a>	.	PISTONLESS ENGINE KIT
<a href="#">ISX141-033</a>	.	PISTONLESS ENGINE KIT
<a href="#">ISX141-038</a>	.	PISTONLESS ENGINE KIT
<a href="#">ISX141-048</a>	.	ENGINE KIT
<a href="#">ISX141-049</a>	.	PISTONLESS ENGINE KIT
<a href="#">ISX141-054</a>	.	ENGINE KIT
<a href="#">ISX141-058</a>	.	ENGINE KIT
<a href="#">ISX141-065</a>	.	ENGINE KIT
<a href="#">ISX141-081</a>	.	ENGINE KIT
<a href="#">ISX141-097</a>	.	PISTONLESS ENGINE KIT
<a href="#">ISX141-273</a>	.	ENGINE KIT (w/out Piston)
<a href="#">ISX141-289</a>	.	PISTONLESS ENGINE KIT

## Cross Reference:

Manufacturer	OEM Number
CATERPILLAR	8C-5230
CATERPILLAR	8C5230
CUMMINS	3678756
CATERPILLAR	1090073
CATERPILLAR	109-0073

Copyright © 2020 PAI Industries, Inc.

All rights reserved. All content is property of PAI Industries, Inc, and may not be reproduced or redistributed in any form.

Any reference to OEM names or OEM product identification numbers/descriptions/model numbers is for identification only and does not indicate that it is an OEM part. PAI is not affiliated with Mack Truck, Inc.®, Volvo®, Fuller®, Cummins®, Eaton®, Rockwell®, Caterpillar®, Freightliner®, Hendrickson®, Kenworth®, Detroit Diesel®, International®, Peterbilt®, or Dana®. All Manufacturer's names, numbers, symbols and descriptions are used for reference only. It is not implied that any part listed is the product of these manufacturers.